



AP4800 Hyperlocation Deployment Guide

Overview 2

How does Hyperlocation work? 2

AP 4800 Antenna System 2

Hyperlocation Deployment 3

Installation and Configuration 7

Revised: October 16, 2018

Overview

Cisco Hyperlocation is an enhanced location solution that takes advantage of the specialized hardware that is available on the Cisco Aironet 4800 Series wireless Access Points. It uses Angle-of-Arrival of Wi-Fi signals to determine the location of connected mobile devices. While other technologies are using RSSI to get location within 10 meters of accuracy, Cisco Hyperlocation can track locations to within three meters in an optimized deployment. You can integrate Cisco Hyperlocation with other Cisco wireless location solutions for additional uses. Combining it with Cisco Workplace Analytics, for instance, can result in more precise utilization analytics that helps you better understand your workplace usage.

This document outlines the best practices to follow when deploying the AP4800 Hyperlocation solution. It outlines specific areas to keep in mind to ensure that the technology produces accurate and precise location measurements as expected by the end user.

Hyperlocation in Cisco Connected Mobile Experiences: The Hyperlocation Solution substantially increases the location accuracy for connected clients of the Connected Mobile Experiences. The FastLocate technology boosts the refresh rate so CMX captures more location data points. And the Angle-of-Arrival capabilities increases location accuracy to as close as one meter (50% Error Distance). The improved accuracy provides more granular analytics data compared to RSSI based location.

Bluetooth Low Energy "BLE" support for CMX: In addition to the Hyperlocation Solution, the AP4800 includes an integrated BLE radio that can detect BLE beacons installed in the venue and transmit BLE Beacons in iBeacon or Eddystone format.

How does Hyperlocation work ?

Hyperlocation radios and antennas are programmed with which MAC addresses they should report for, this is based on the associated clients of "surrounding" AP's. Surrounding APs are based on which AP can hear the packets from the client serving AP/radio that has the Hyperlocation AP (L1 List). When clients are "quiet" the serving radio is interrupted to send BAR (Block Acknowledgement Request) packets to the client to wake it up. Location is a "FUSION" of the RSSI calculated location and AoA calculated location if both are available.

AP 4800 Antenna System

The Hyperlocation (circular antenna array) is a 16-element antenna design that provides 360-degree coverage around the access point. It is designed to provide precise RF Angle-of-Arrival (AoA) information providing the embedded software the data required to calculate location using a more granular approach.

If you could take the cover off the product, here is how it would break down: 4 macro- and 4 micro-cell elements for client connectivity, 16 element circular antenna array for Hyperlocation, 4 elements of the array are used as an omnidirectional antenna for monitoring and the BLE antenna in the center.

Figure 1: AP4800 Antenna System

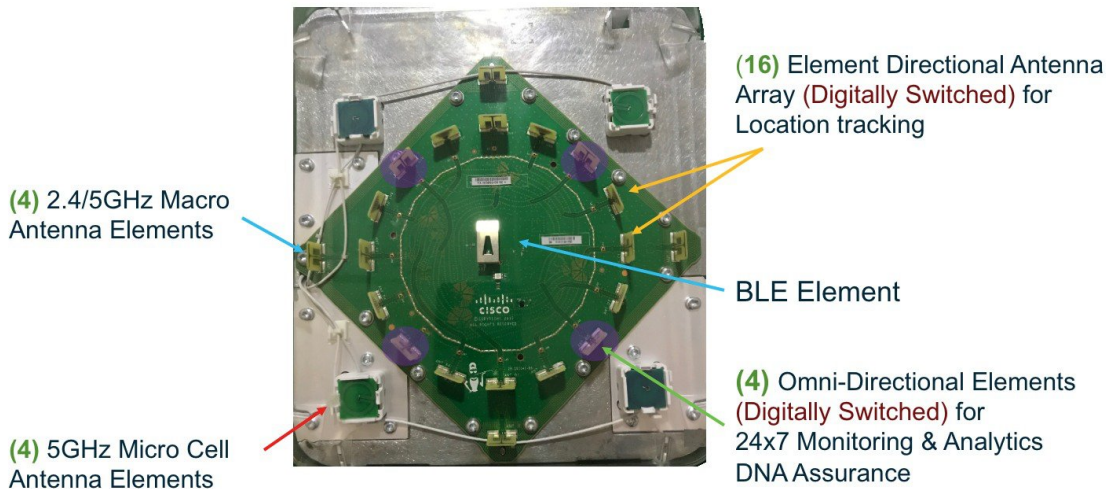

Hyperlocation Deployment

Before installing Hyperlocation it would be good for the installer/operator to become familiar with the operation of Cisco Prime Infrastructure, CMX and current methods of performing Real Time Location Systems (RTLS) using conventional signal strength (RSSI) if possible. Refer to the Chapter: Best Practices—Location-Aware WLAN Design Consideration of the Wi-Fi Location-Based Services 4.1 Design Guide at <https://www.cisco.com/c/en/us/td/docs/solutions/Enterprise/Mobility/WiFiLBS-DG/wifich5.html> for AP placement and more site survey details.

Preparing the Site for Hyperlocation

It is very important that the installer and network administrator work together to determine proper AP placement from both a physical installation and a software location placement onto the Prime Infrastructure (PI) map. It is critical that the administrator properly and accurately document the X, Y position, height and antenna orientation of the APs on the map.

Tools that can assist with this job would be:

- A plumb bob (weighted string) to can mark the location of the ceiling mounted AP on the floor
- Laser range finder or measurement wheel (to measure distances accurately)
- Tri-Pod or other leveling device for use with laser
- Laser pointer

Figure 2: Example Leica DISTO E7500i 660ft Laser Distance Measurer w/Sketch iPad iPhone App



Physical Placement of the Hyperlocation Access Point

Some basic guidelines on Site Surveys or deployments are:

- Try to maintain consistent -65 dBm RSSI for data, voice, video, location
- In order to achieve the best accuracy results, a site survey is required
- 20% cell overlap for optimized roaming and location calculations
- A good rule of thumb is 1 Access Point per 2,500 square feet / 250m² (best performance) or more, but site specific. AP density should be determined through a site survey
- Keep AP to AP distance below 50ft / 15m
- Keep AP height below 15ft / 4.5m
- For location create a convex hull around the coverage area, start with AP's placed on the perimeter
- For high density applications, it is recommended to add an additional AP in the middle of dense areas
- Additionally, try to stagger the APs so you cover the perimeter and try to design so that at least four APs are within line of sight of the clients
- Do not mount APs for Hyperlocation above ceiling tiles. Obstruction and metal elements will dramatically degrade the Hyperlocation performance
- If there is a requirement to mount the AP4800 access point on a wall, in-ceiling, hide or change the color. Mounting kit for optimal AP positioning are available from Cisco partners and third-party solution providers

Figure 3: Recommended AP spacing is typically 1 Access Point per 2,500 square feet / 250m²

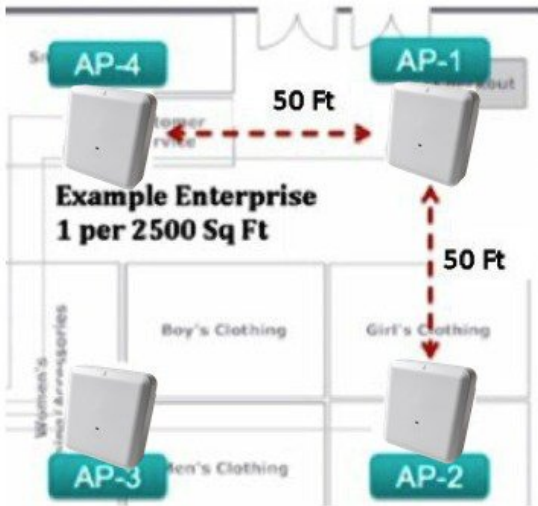
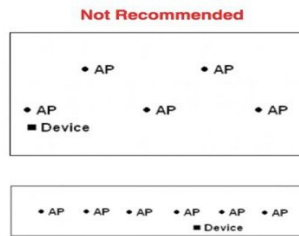
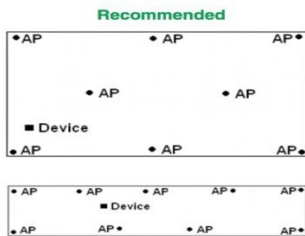
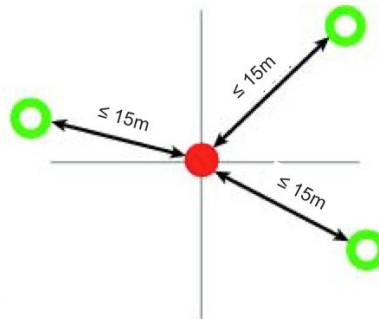

Figure 4: Basic Rules for AP placement for wireless location

Basic Rules

- Deploy minimum of 4 APs per floor
- One AP around client in each quadrant
- -75 dBm Client RSSI on 3 APs
- Create a convex hull around location area



© 2018 Cisco and/or its affiliates. All rights reserved. Cisco Confidential

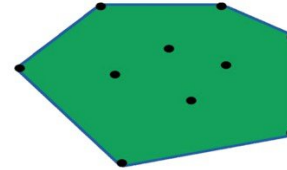

Importance for Hyperlocation

For optimal performance unobstructed line of sight between the client and four Hyperlocation APs is important. Location is only good inside the convex hull formed by the APs. Even with using AoA the performance of Hyperlocation suffers when the clients are outside the convex hull.

You should capture the following after mounting the AP:

- AP name and AP MAC address

- Map location of the AP
- Exact position with an accuracy of 1ft / 30cm. You can capture the exact distance to two walls or three points. This can be used in Prime Infrastructure to exactly position the AP on the map
- Orientation of the AP: Azimuth with an accuracy of 5 degrees. Hyperlocation APs should be mounted horizontally, so elevation is always 0 degrees. The AP has an arrow, which helps you identifying the antenna orientation. You will save a lot of time if you can align all APs on a floor to point in the same direction.

In Prime Infrastructure 0° is pointing to the right, 90° down, 180° to the left and 270° to the top of the map



Note In Prime Infrastructure the default azimuth of an AP when added to a map is 90°. Mounting the APs with the arrow pointing to 90° would save time when positioning the APs on the floorplan in Prime Infrastructure.

Figure 5: Azimuth in Prime Infrastructure

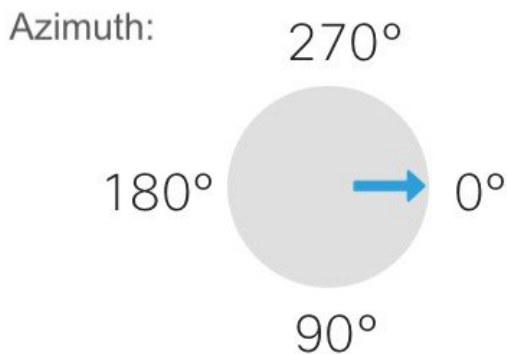

Figure 6: AP4800 with arrow to indicate azimuth direction



Location errors are compounded when the locations of Hyperlocation APs are not properly documented.

If you are mounting the units to the ceiling grid, it is recommended that you orientate all of the Access Points in the same direction. This will make it easier when recording them. If you are not mounting to the ceiling rails, use a laser pointer or other device to try and align them in the same direction.

Oftentimes, it is difficult to measure and map the location when the AP4800 unit is mounted high on a ceiling. In these cases, it is suggested that the use of a plumb bob dropped from the center of the AP or a laser pointer be used to mark the exact location on the floor so that a tape measure or laser range finder can be used.

Mixed Mode

Mixing of AP4800 Hyperlocation APs and Non-Hyperlocation APs on the same map a feature included in CMX 10.5. This is meant for areas where higher accuracy is needed. High accuracy areas then will be covered with AP4800 while in other areas on the map Non-Hyperlocation APs can be used. Hyperlocation APs have to create a convex hull around this zone and all additional APs inside the zone also have to support Hyperlocation. A salt-and-pepper design is not supported.

Installation and Configuration

Prerequisites

Cisco Wireless LAN Controller

The following Wireless LAN Controllers are supported:

- Cisco 3504 Wireless Controller
- Cisco 5520 Wireless Controller

- Cisco 8540 Wireless Controller

Virtual Wireless LAN Controller and Mobility Express are not supported for Hyperlocation.

Minimum WLC Software Version for AP4800 with Hyperlocation is AireOS 8.7.106.

CMX needs a read-write SNMPv2 community or a SNMPv3 user with read-write access on the WLC.

Prime Infrastructure

PI is needed to create the necessary floor plans, position APs on the map and create GPS markers.

Minimum Prime Infrastructure is PI 3.4.

After adding the WLCs to PI joined APs will be added automatically to the device list. See next chapter for adding and placing APs on the floorplans.

Networking and Firewall

If any firewalls exist between WLC and the CMX server the following ports need to be open:

- 16113 NMSP
- 2003 Fastpath for AoA and FastLocate data
- 443 HTTPS
- 161, 162 SNMP
- ICMP

Network Time Protocol (NTP)

Hyperlocation requires exact clock synchronization for Access Points, Wireless Controller and CMX. NTP is a hard requirement and operation without working NTP is not supported. NTP settings on the WLC can be found at: **Wireless > Access Points > Global Configuration > Hyperlocation** provides the NTP configuration for the APs. This NTP needs to be reachable from the AP subnets. See the Enable Hyperlocation section for configuration details.

AP placement in Prime Infrastructure

The following steps are necessary before you can start adding APs to the map:

- Create your map hierarchy: Campus – Buildings–Floors
- Properly size the floors. The height should match your highest AP mounting position on that floor. The AP height will default to your ceiling height
- Select the Floor Type RF model which is the closest match to your environment: Cubes and Walled Offices, Drywall Office Only, Outdoor Open Space, Indoor High Ceiling (Figure 7 Select the correct Type (RF Model))
- Add the floorplan image and scale it correctly
- Add the APs to the floors and position them. (Figure 8 AP position and orientation)
- Drag the APs to the correct location or use Position by 3 points / 2 walls to position the AP (Figure 8 AP position and orientation)
- Orientation of the Hyperlocation Antenna must be entered correctly.

Figure 7: Select the correct Type (RF Model)

New Floor ✕

Floor Name

Contact

Floor Number

Floor Height (Meters)

Type (RF Model) Cubes And Walled Offices
 Drywall Office Only
 Outdoor Open Space
 Indoor High Ceiling

Image File Name

Click to select a file or drag it here

Civic Location

Latitude

Longitude

Dimensions (Meters)

Width

Length

Position (Meters)

Horizontal

Vertical

Figure 8: AP position and orientation

Selected AP Details ✕

Position by 3 points 2 walls

AP Name AP01-6288

MAC Address 70:69:5a:63:05:20

AP Model AIR-AP4800-E-K9

x m

y m

AP Height m

XOR (2.4GHz)

Antenna:

Azimuth: Elevation:

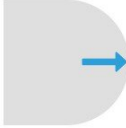

Figure 9: Verify Antenna Orientation by clicking on AP

Selected AP Details
✕

Position by 3 points 2 walls

AP Name	AP01-6288
MAC Address	70:69:5a:63:05:20
AP Model	AIR-AP4800-E-K9
x	<input type="text" value="11.91"/> m
y	<input type="text" value="7.10"/> m
AP Height	<input type="text" value="3.000"/> m

XOR (2.4GHz) 802.11a/n/ac **802.11a/b/g/n/ac**

Antenna:

Azimuth: Elevation:



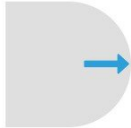

Figure 10: Verify Antenna Orientation by clicking on AP

• Info ● Rx Neighbors
↗

ASSOCIATED

Name AP01-6288

MAC Address 70:69:5a:63:05:20

Model AIR-AP4800-E-K9

Op./Admin/Mode up / up / Local

TYPE	OP./ADMIN	CHANNEL	ANTENNA	AZIMUTH	ELEVATION
XOR (2.4GHz)	up / up	1	Internal-4800-Dual-2.4GHz	180°	0°
802.11a/n/ac	up / up	100	Internal-4800-5GHz	180°	0°
802.11a/b/g/n/ac	up / up	0	AIR-ANT-LOC-4800	180°	0°



Note AP templates can help applying antenna orientation to a bulk of APs

For more details on how to work with Wireless Site Maps in PI see the PI User Guide at https://www.cisco.com/c/en/us/td/docs/net_mgmt/prime/infrastructure/3-4/user/guide/bk_CiscoPrimeInfrastructure_3_4_0_UserGuide/bk_CiscoPrimeInfrastructure_3_4_0_UserGuide_chapter_01010.html

One common error is APs are at the right position, but swapped. i.e. AP has been installed on a location for another AP. To verify on site the right AP is at the right location you can use the blink LED feature of the AP. On the WLC go to **Wireless > Access Points > All APs** > select the AP in question > go to advanced tab > select the LED flash state. The LED will start blinking blue – red – green.

Figure 11: Flash AP LED from WLC

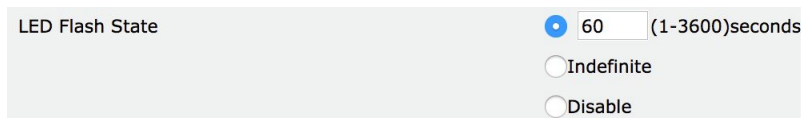

The Cisco Wireless mobile application for iOS and Android can also be used to blink the AP LED. Use the app to connect to your WLC, in the app select **Access Points > select the AP in question > scroll down to the bottom of the page > click “Blink AP LED”**.

Figure 12: Use Cisco Wireless app to blink AP LED

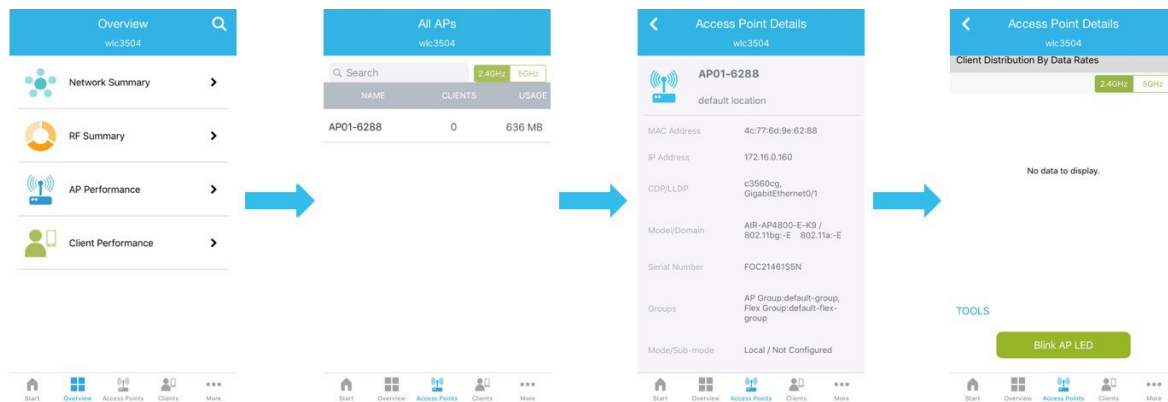

After you have finished and verified the maps you need to export them following these steps:

- Go to Maps > Site Maps and select Export Map Archive from the drop down

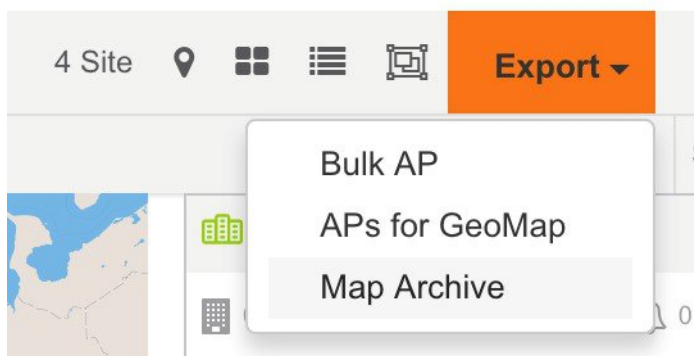

- Select the sites you want to export to CMX, leave Map Information and Calibration information ON and include the calibration information for selected maps

- Select “Generate Map Archive”, this will initiate the download to your PC.

CMX Installation

Hyperlocation with AP4800 requires CMX 10.5. Hyperlocation is only supported on CMX hardware appliance and high-end virtual appliances. See Appendix URL #4 and URL #5 for installation instructions.

- CMX virtual appliance Installation Guide https://www.cisco.com/c/en/us/td/docs/wireless/mse/10-4/installation/guide/installation_guide_104.html
- Cisco MSE 3365 Installation Guide: <https://www.cisco.com/c/en/us/td/docs/wireless/mse/3365/installation/guide/mse3365-installation-guide.html>

Before turning on the VM the first time it is recommended to increase the disk size to 1 TB by editing the VM settings.

Make sure to have a proper network configuration:

- Hostname should be changed from localhost to a FQDN
- Valid NTP and time zone configuration

After OS configuration you will be asked to connect to CMX via HTTPS on port 1984. After login with username cmxadmin you will be prompted to select the installation type. Select: Location (Figure 11 Service Selection). Presence does not support Hyperlocation. You can add a secondary server for high availability at anytime later on.

Figure 13: Service Selection

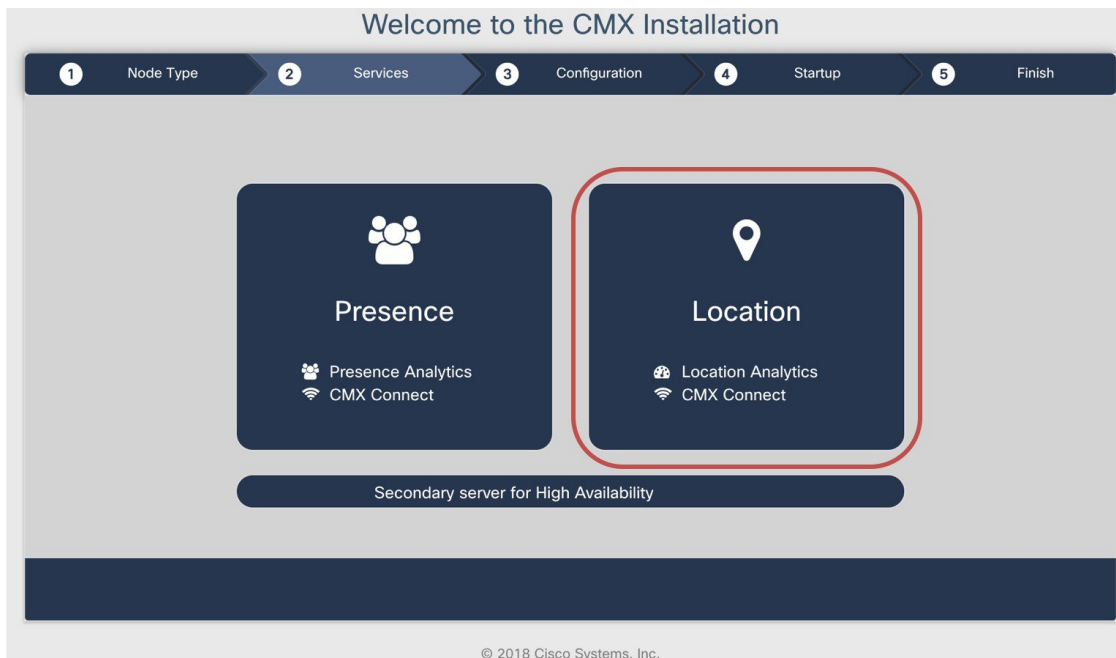

After CMX has been installed for location you will be prompted to continue with the setup. Click the link.

Figure 14: Finished CMX Installation



This will redirect you to the CMX setup assistant

Figure 15: CMX Setup Assistant

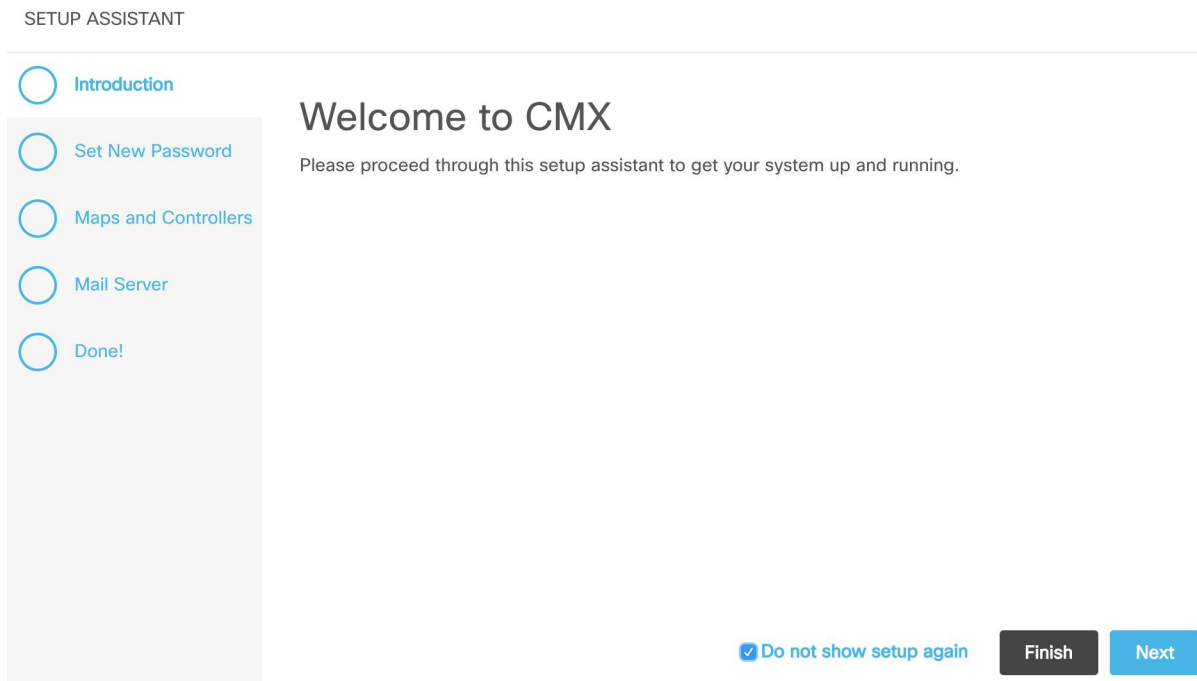

The setup assistant allows you only to import all maps and controllers from PI to CMX. If you want only to import selected maps and wireless controllers only cancel the assistant after setting the password for the GUI admin user and follow the steps below. Do not forget to finish the Mail Server configuration later.

Hyperlocation Configuration

After CMX installation has been finished, reboot the system and verify configuration and NTP. Login to the console or via SSH:

Use: `cmxos verify` to check VM configuration. For Hyperlocation you should meet the requirements for a high-end VM:

- 20 vCPUs, 64 GB Memory, 1 TB Disk space

```
[cmxadmin@cmx ~]$ cmxos verify
```

Check	Minimum Required	Actual	Result
Memory	24GB	64GB	✓
CPU	8	20	✓
Disk	150GB	1024GB	✓
hostname	RFC Compliant Hostname	cmx.cisco.local	✓

```
[cmxadmin@cmx ~]$
```

Use: `ntpstat` to check NTP is working correctly. IP of the NTP server should match your configuration. Output should say “synchronized to NTP server”.

This guide will show the manual process of exporting / importing maps and adding controllers. See the CMX Configuration Guide at https://www.cisco.com/c/en/us/td/docs/wireless/mse/10-3/cmx_config/b_cg_cmx103.html

- Import maps to CMX by navigating to System > Settings > Controllers and Maps Setup > Advanced

Tracking

Filtering

Location Setup

Data Privacy

Data Retention

Mail Server

▼ Controllers and
Maps Setup

Import

Advanced

Upgrade

High Availability

Maps

Please select maps to add or modify:

ImportExport_29ed81e199b41f0c.tar.gz [Browse...](#)

Delete & replace existing maps & analytics data

Delete & replace existing zones

Keine ausgewählt

[Upload](#)

Controllers

Please add controllers by providing the information below:

Controller Type

IP Address

Controller Version
[Optional]

Controller SNMP Version

Controller SNMP Write
Community

[Add Controller](#)

[Close](#)

[Save](#)

Browse to the map export file you created with PI and upload.

- Add wireless controllers by navigating to System > Settings > Controllers and Maps Setup > Advanced

Tracking

Filtering

Location Setup

Data Privacy

Data Retention

Mail Server

▼ Controllers and
Maps Setup

Import

Advanced

Upgrade

High Availability

Maps

Please select maps to add or modify:

 Delete & replace existing maps & analytics data Delete & replace existing zones

Controllers

Please add controllers by providing the information below:

Controller Type

IP Address

Controller Version
[Optional]

Controller SNMP Version

Controller SNMP Write
Community

Enable Hyperlocation on WLC

First verify the NTP settings for the WLC.

Figure 16: Adding NTP time server address into the controller

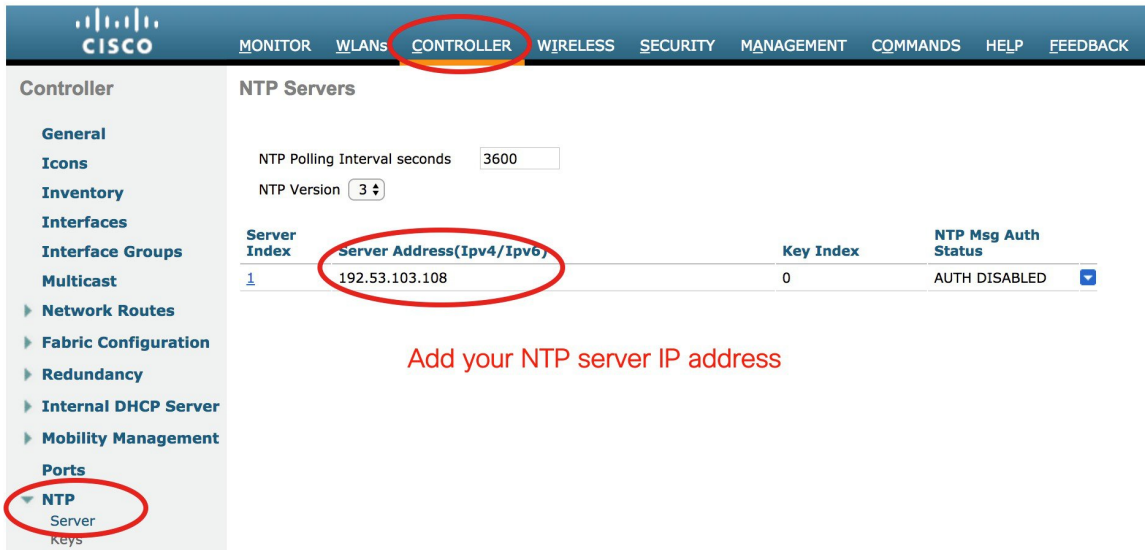

After configuring NTP for the WLC you can enable Hyperlocation for the APs. You also need to set a NTP server IP for the Access Points through the Hyperlocation setting. This NTP server must be reachable from the AP subnet.

Figure 17: Adding NTP Server to the Hyperlocation Parameters

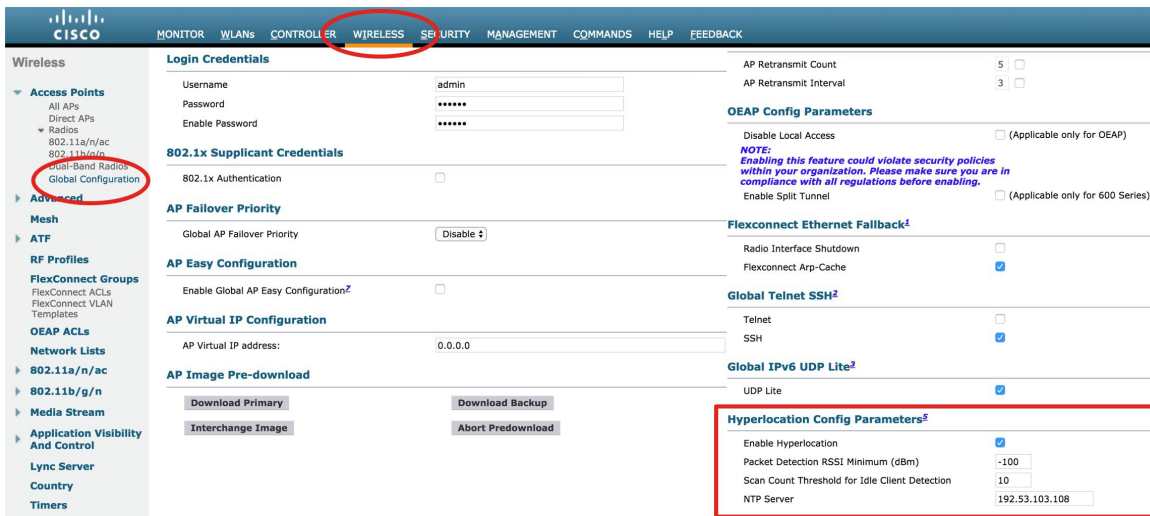

Login to WLC via SSH or console and check the NTP server is synced.

Figure 18: Use show time on WLC to check NTP sync status

```
(Cisco Controller) >show time
Time..... Mon Jul 23 14:39:24 2018
Timezone delta..... 0:0
Timezone location..... (GMT +1:00) Amsterdam, Berlin, Rome, Vienna
NTP Servers
NTP Version..... 3
NTP Polling Interval..... 3600
-----
Index      NTP Key Index      NTP Server      Status      NTP Msg Auth Status
-----
1          0                  192.53.103.108  In Sync      AUTH DISABLED
```

To verify proper NTP operation on the APs login to the AP via SSH or console.

Figure 19: Use show ntp on AP to verify NTP settings

```
AP01-6288#show ntp
NTP server      Stratum  Version  Last Received  Delay  Offset  Jitter
192.52.103.108  1        4        9sec ago      26.258ms  -0.130ms  0.233ms
AP01-6288#
```

Enable Hyperlocation on CMX

Go to **System > Settings > Location Setup** and enable Hyperlocation.

Figure 20: Enable Hyperlocation

SETTINGS
✕

- Tracking
- Filtering
- Location Setup
- Data Privacy
- Data Retention
- Mail Server
- Controllers and Maps Setup
- Upgrade
- High Availability

Location Calculation Parameters

Enable OW Location

Use Default Heatmaps for Non Cisco Antennas

Enable Hyperlocation / FastLocate / BLE Management

Use Chokepoints for Interfloor conflicts

NEVER

Enable Location Filtering

Chokepoint Usage

Optimize Latency

Chokepoint Out of Range Timeout (secs)

60

Relative discard RSSI time (secs)

600

Relative discard AoA time (secs)

180

Absolute discard RSSI time (mins)

60

RSSI Cutoff (dBm)

-75

Movement Detection Parameters

Individual RSSI change threshold

5

Aggregated RSSI change threshold

3

Many new RSSI change percentage threshold

20

Many missing RSSI percentage threshold

20

Close
Save

Restart CMX services

After enabling Hyperlocation on CMX it is required to restart the services. Login to the console or through SSH and use the `cmxctl stop` and `cmxctl start` command to stop and restart the services. Check with `cmxctl status` if Hyperlocation service is running.

```
[cmxadmin@cmx ~]$ cmxctl status
Done
The nodeagent service is currently running with PID: 14878
+-----+-----+-----+-----+
| Host           | Service       | Status  | Uptime (HH:mm) |
+-----+-----+-----+-----+
+
+-----+-----+-----+-----+
| cmx.cisco.local | Hyperlocation | Running | 0 days, 58:02  |
+-----+-----+-----+-----+
[cmxadmin@cmx ~]$
```

Restart APs

After enabling Hyperlocation on CMX it is also required to restart the APs. Use Prime Infrastructure, the WLC GUI or WLC CLI to restart APs. You can also power cycle the APs from the Switch.

Figure 21: WLC GUI to reset APs: Wireless --> All APs --> select individual AP --> General

Hardware Reset

Perform a hardware reset on this AP

Reset AP Now

Mixed Mode Deployment

If you have a deployment where only zones are covered with AP4800 and other APs on the same map do not support Hyperlocation you have to enable Mixmode for this floor. Mixmode needs to be enable per floor on the CMX CLI with the `cmxctl config hyperlocation mixmode` command. See the CMX Command Reference Guide at https://www.cisco.com/c/en/us/td/docs/wireless/mse/10-4/cmx_command/cmxcli104/cisco_cmx_commands.html

You have to restart CMX services after enabling mixmode.

Verify Hyperlocation settings

Before starting testing location accuracy, it is recommended to verify Hyperlocation is configured correctly.

Verify on WLC

On the WLC GUI navigate to **Monitor > Cloud Service > CMX**.

CMX Server IP	Services	Sub-Services	AP Monitor Service Configuration	Group Subscriptions
10.0.0.9	RSSI Info Statistics	Mobile Station Mobile Station	Hyper location UDP Server IP : 10.0.0.9 Hyper location UDP Server Port : 2003	None
34.242.70.61	RSSI Info AP Info	Mobile Station Mobile Station Subscription		None

The AP Monitor Service Configuration should show the IP of your CMX. This is the Fastpath configuration of the APs for AoA data. If you have multiple APs connected with your WLC check the Group Subscription.

Verify using CLI

Login to your WLC via console or ssh. Use the command `show nmsp subscription detail` to show your CMX IP under Halo UDP Server IP Address:

```
(Cisco Controller) >show nmsp subscription detail
```

Mobility Services Subscribed by 10.0.0.9

Services	Sub-services
RSSI	Mobile Station,
Info	Mobile Station,
Statistics	Mobile Station,
AP Monitor	Subscription
AP Info	Subscription

AP Monitor Service Configuration:

```
Halo UDP Server IP Address..... 10.0.0.9
Halo UDP Server Port..... 2003
```

Use the command `show advanced hyperlocation summary` to check Hyperlocation is UP on all your AP4800.

```
(Cisco Controller) >show advanced hyperlocation summary
```

```
Hyperlocation..... UP
Hyperlocation NTP Server..... 192.53.103.108
Hyperlocation pak-rssi Threshold..... -100
Hyperlocation pak-rssi Trigger-Threshold..... 10
Hyperlocation pak-rssi Reset-Threshold..... 8
Hyperlocation pak-rssi Timeout..... 3
```

AP Name	Ethernet MAC	Slots	Hyperlocation	Explicit AP config
AP03-625C	70:69:5a:63:02:60	3	UP	0
AP02-627C	70:69:5a:63:04:60	3	UP	0
AP01-6288	70:69:5a:63:05:20	3	UP	0

Verify on CMX

Verify APs on maps

On CMX GUI navigate to the System dashboard and check coverage details for missing or inactive APs.

Coverage Details

Access Points			
Placed AP	Missing AP	Active AP	Inactive AP
10	0	10	0

- Placed AP: Number of APs placed on the imported maps
- Missing AP: CMX is getting data from AP, but the AP is not placed on a map; check your maps
- Active AP: Number of AP CMX is getting data and placed on map
- Inactive AP: AP is placed on map, but CMX is not getting data, should be zero

Check for incoming AoA messages

Make sure at least one client is connected to your wireless network and to one of your Hyperlocation APs. On CMX navigate to System > Metrics and select the Location Metrics. Hyperlocation Rate should be different from zero. The example screenshot shows a single client.

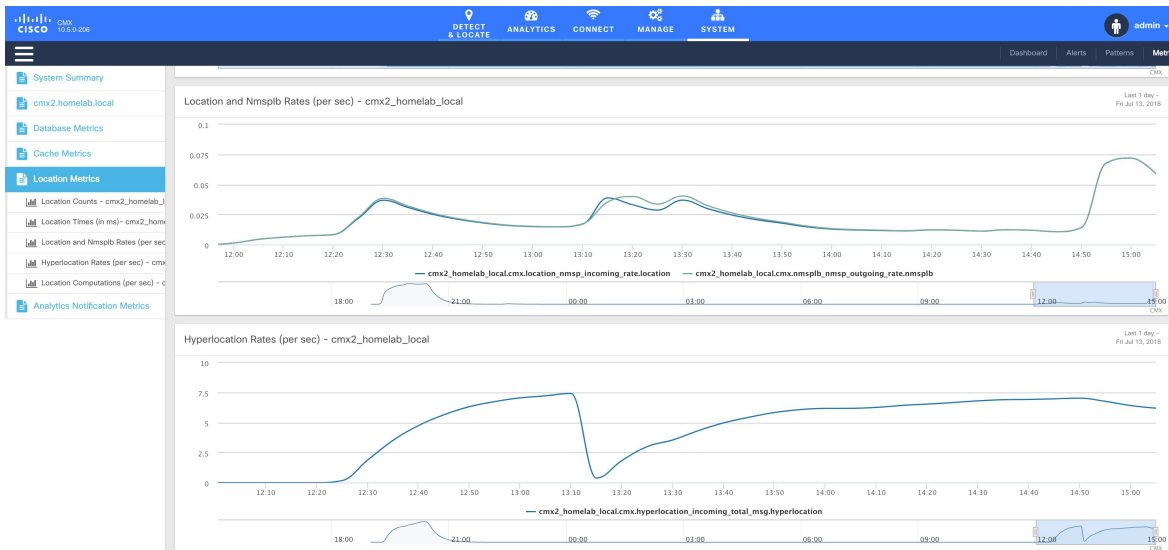

Accuracy Testing

You need at least one connected client for accuracy testing. Creating a 5 GHz only WLAN SSID will ensure you have the most accurate location test.

Figure 22: WLAN configuration for 5 GHz-only SSID

The screenshot shows the Cisco WLAN configuration interface for a profile named 'CMX_accuracy_testing'. The interface is divided into several tabs: General, Security, QoS, Policy-Mapping, and Advanced. The 'General' tab is currently selected. The configuration fields are as follows:

Field	Value
Profile Name	CMX_accuracy_testing
Type	WLAN
SSID	CMX_accuracy_testing
Status	<input checked="" type="checkbox"/> Enabled
Security Policies	[WPA2][Auth(802.1X)] (Modifications done under security tab will appear after applying the changes.)
Radio Policy	802.11a only
Interface/Interface Group(G)	clients
Multicast Vlan Feature	<input type="checkbox"/> Enabled
Broadcast SSID	<input checked="" type="checkbox"/> Enabled
NAS-ID	none

Accuracy testing is done with a static device. Make sure your test points are inside the convex hull of your AP coverage. It is recommended to collect 25-50 samples per point. Repeat the test in multiple locations throughout your coverage area. Accuracy tests will not improve location accuracy as the results will not be used for any kind of calibration. You might want to use different clients at the same location to understand the client impact on accuracy.

- Choose a client for your accuracy test
- Pick multiple points across your venue, note the X, Y of your test points
- Execute the test on each of the points and collect 25-50 measurements per point
- Finish the test and review the test results

You can execute the tests using GUI or CLI. GUI is a bit more comfortable, while CLI gives you a few more details while the test is executed.

Testing accuracy using GUI

To execute accuracy tests, via the GUI on CMX navigate to the Detect & Locate tab. Selecting the client (green dot on the map) will expand the Client details pane on the left. Use the pin icon to start the test. The number of samples will be updated. After collecting enough sampled click pause and then finish to end the test.

Figure 23: GUI accuracy testing

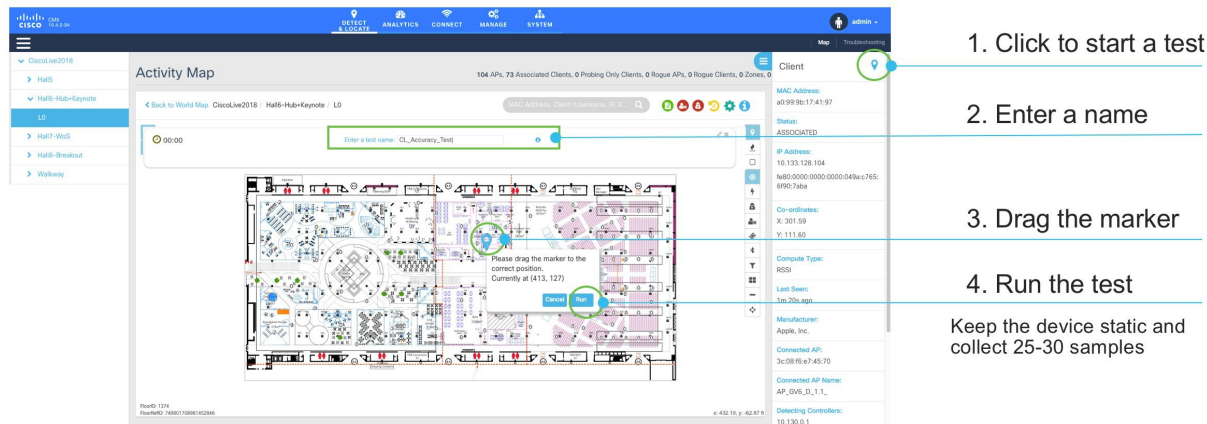

1. Click to start a test

2. Enter a name

3. Drag the marker

4. Run the test

Keep the device static and collect 25-30 samples

Test results can be viewed by clicking on the green icon .

Testing accuracy using CLI

You need the X, Y of your test points. You can use the CMX GUI Detect & Locate tab, select the map and move your mouse pointer to the test point, you can read the X and Y coordinates on the bottom right of your map.

Figure 24: Get X, Y of your test point: Hover mouse over map position, read X, Y on bottom right

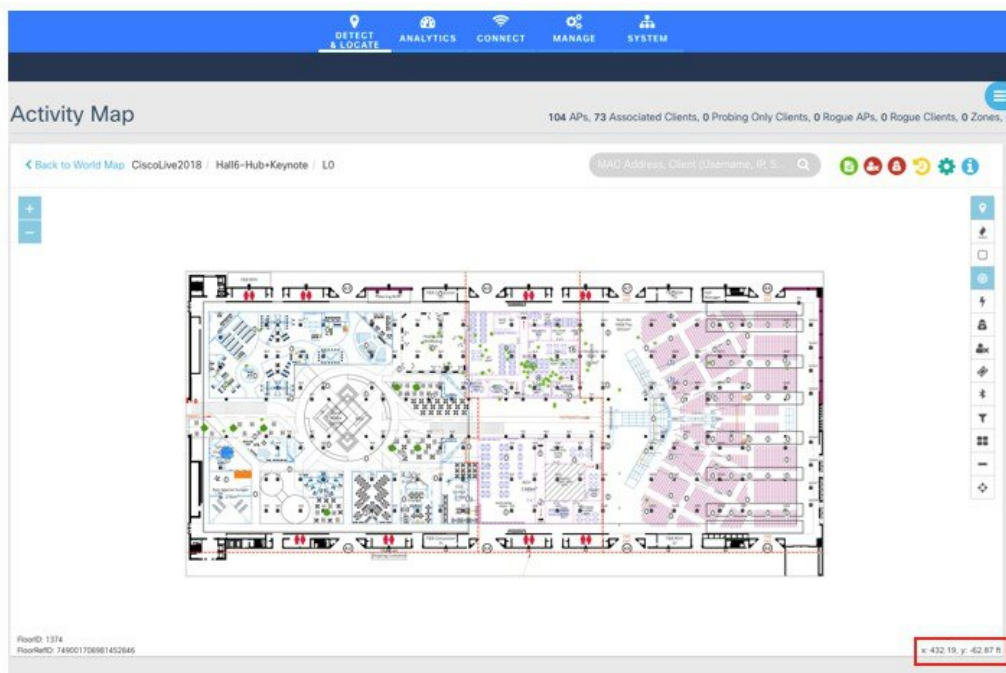

Login using console or SSH to your CMX. To start a location accuracy test, use the `cmxloc start` command. You will be prompted to enter the client MAC address, a test name and the X, Y of the real location. You can also select the duration of the test.

```
[cmxadmin@cmx ~]$ cmxloc start
MAC address: 40:98:ad:71:e8:b9
```

MAC Address	X	Y	Comp Type	Location	Last Located	Current Server Time
40:98:ad:71:e8:b9	23.87	30.08	FUSION	SJ>Cisco>Floor1	2018-07-13T20:01:29.942+0200	2018-07-13T20:01:31.760+0200

```
Accuracy test name: Test 1
X: 38
Y: 25
Test time in minutes [5]: 5
User input entered on: 2018-07-13 20:02:54
```

During the test you will see the computation method of each data point: RSSI, AoA or FUSION.

Figure 25: Output during accuracy test

Time	X	Y	Distance (m)	Comp Type
2018-07-13T20:12:32.191+0200	27.23	22.4	1.79	FUSION
2018-07-13T20:12:34.328+0200	27.21	22.41	1.79	FUSION
2018-07-13T20:12:36.483+0200	28.0	23.37	1.81	AOA
2018-07-13T20:12:38.586+0200	27.97	23.33	1.8	AOA
2018-07-13T20:12:40.593+0200	26.31	21.64	1.91	FUSION

To view the test results, use the cmxloc list, cmxloc download can be used to prepare a zip file which is helpful for troubleshooting. Use the provided URL, replace the server_ip with the IP of your CMX server to download the zip file.

Figure 26: Listing and downloading test results

```
[cmxadmin@cmx ~]$ cmxloc list
```

Name	Status	MAC Address	Comp Freq. (s)	Avg. Error (m)	90% (m)	50% (m)	Test Points
Test 1	FINISHED	40:98:ad:71:e8:b9	3.0	5.35	6.93	4.85	4
Test 2	FINISHED	40:98:ad:71:e8:b9	2.19	1.97	2.69	1.81	21

```
[cmxadmin@cmx ~]$ cmxloc download
Test name: Test 1
Logs can be downloaded from web: https://server_ip/common/data/cmx_latest_accuracy_log.zip
```

Understanding the test results

On CMX GUI navigate to Detect & Locate and click the green icon to view the test results table.

Figure 27: Location Accuracy Test Results

Location Accuracy Test

Show 8 entries Search:

Test	Name	Status	Mac Address	Floor	Start Time	Location Computation Frequency (s)	Measurements on Correct Floor (%)	10m Accuracy (%)	Average Error Distance (m)	90% Error Distance (m)	75% Error Distance (m)	50% Error Distance (m)
	Test 1	finished	40:98:ad:71:e8:b9	Munich>Home>Home lab1	2018-07-13 08:02pm	3.0	100	100.0	5.35	6.93	6.36	4.85
	Test 2	finished	40:98:ad:71:e8:b9	Munich>Home>Home lab1	2018-07-13 08:12pm	2.2	100	100.0	1.97	2.69	2.24	1.81

Showing 1 to 2 of 2 entries Previous 1 Next

The table shows the following columns:

- Test: allows you to relaunch, download and send an e-mail with the test results
- Name: Name of the test
- Status: running, paused or finished. You can pause and finish a running test from here.
- Mac Address of the test device
- Floor of the accuracy test
- Start Time of the test
- Location Computation Frequency: Average time between location updates / calculations during the test. Should be better than 10s for Hyperlocation
- Measurements on Correct Floor in %: In some situation, especially when there are atriums / open ceilings the client will be detected from APs on other floors as well and the algorithm might choose the wrong floor
- 10m Accuracy in %: How many of the calculations are within 10 meters of the real location during the test.
- Average distance error in meters: averaged location error during the test
- 90% / 75% / 50% error distance in meters: This indicates the radius of 90% / 75% and 50% of the calculated locations around the real location. Good deployments should be in the range of 1-3m for the 50% error distance

Appendix

1. Cisco Aironet Series 4800 Access Point Deployment Guide: https://www.cisco.com/c/en/us/td/docs/wireless/controller/technotes/8-7/b_cisco_aironet_series_4800_access_point_deployment_guide.pdf
2. Cisco CMX Command Reference Guide: https://www.cisco.com/c/en/us/td/docs/wireless/mse/10-4/cmxc_command/cmxccli104/cisco_cmxc_commands.html
3. Cisco Prime Infrastructure User Guide: https://www.cisco.com/c/en/us/td/docs/net_mgmt/prime/infrastructure/3-4/user/guide/bk_CiscoPrimeInfrastructure_3_4_0_UserGuide.html
4. CMX virtual appliance Installation Guide: https://www.cisco.com/c/en/us/td/docs/wireless/mse/10-4/installation/guide/installation_guide_104.html
5. Cisco MSE 3365 Installation Guide: <https://www.cisco.com/c/en/us/td/docs/wireless/mse/3365/installation/guide/mse3365-installation-guide.html>
6. Wi-Fi Location-Based Services 4.1 Design Guide: <https://www.cisco.com/c/en/us/td/docs/solutions/Enterprise/Mobility/WiFiLBS-DG.html>
7. Cisco CMX Configuration Guide: https://www.cisco.com/c/en/us/td/docs/wireless/mse/10-3/cmxc_config/b_cg_cmxc103.html



Americas Headquarters
Cisco Systems, Inc.
San Jose, CA 95134-1706
USA

Asia Pacific Headquarters
CiscoSystems(USA)Pte.Ltd.
Singapore

Europe Headquarters
CiscoSystemsInternationalBV
Amsterdam,TheNetherlands

Cisco has more than 200 offices worldwide. Addresses, phone numbers, and fax numbers are listed on the Cisco Website at www.cisco.com/go/offices.