



Cisco Identity Services Engine Administrator Guide, Release 2.2

Americas Headquarters

Cisco Systems, Inc.
170 West Tasman Drive
San Jose, CA 95134-1706
USA
<http://www.cisco.com>
Tel: 408 526-4000
800 553-NETS (6387)
Fax: 408 527-0883



CONTENTS

[Full Cisco Trademarks with Software License](#) ?

PART I

Introduction 51

CHAPTER 1

Cisco ISE Features 1

- Cisco ISE Overview 1
- Key Functions 2
- Identity-Based Network Access 2
- Support for Multiple Deployment Scenarios 3
- Support for UCS Hardware 3
- Basic User Authentication and Authorization 3
- Policy Sets 4
- Support for Common Access Card Functions 5
- Client Posture Assessment 5
- Mobile Device Manager Interoperability with Cisco ISE 6
- Profiled Endpoints on the Network 6
- pxGrid Persona 6
- TACACS+ Device Administration 6
- Support for SXP 7
- Third Party Device Support 7
- Telemetry 7
- IPv6 Support 8
- Location Based Authorization 8
- Cisco ISE Certificate Authority 9
 - Certificate Provisioning Portal 9

Certificate Template Extension	9
Cisco ISE Internal CA Issues Certificates to ASA VPN Users	9
Support for Active Directory Multidomain Forests	9
Support for Automatic Failover for the Administration Node	9
GUI-Based Upgrade	10
Technical Support Tunnel for Advanced Troubleshooting	10

CHAPTER 2
Navigate the Admin portal 11

Administration Portal	11
Cisco ISE Home Dashboards	13
Configuring Home Dashboards	14
Context Visibility Views	15
Dashlets	17
Filtering Displayed Data in a View	18
Endpoint Actions in Dashlet Views	21
Attributes in Context Visibility	21
Cisco ISE Internationalization and Localization	22
Supported Languages	22
End-User Web Portal Localization	23
Support for UTF-8 Character Data Entry	23
UTF-8 Credential Authentication	23
UTF-8 Policies and Posture Assessment	24
Cisco NAC and MAC Agent UTF-8 Support	24
UTF-8 Support for Messages Sent to Supplicant	24
Reports and Alerts UTF-8 Support	24
UTF-8 Character Support in the Portals	25
UTF-8 Support Outside the Cisco ISE User Interface	28
Support for Importing and Exporting UTF-8 Values	28
UTF-8 Support on REST	28
UTF-8 Support for Identity Stores Authorization Data	29
MAC Address Normalization	29

CHAPTER 3
What Is Wireless Setup 31

Configure Wireless Controllers in the Wireless Network	34
--	----

Active Directory with Wireless Setup 35

Guest Portals in Wireless Setup 36

Wireless Network Self-Registration Portal 37

Wireless Network Sponsored Guest Flow 37

Wireless Setup BYOD Flow - For Native Supplicant and Certificate Provisioning 37

802.1X Wireless Flow 39

Changes on Cisco ISE and Wireless Controller by the Wireless Setup flow 40

PART II

Deploy Cisco ISE Nodes 43

CHAPTER 4

Set Up Cisco ISE in a Distributed Environment 45

Cisco ISE Deployment Terminology 45

Personas in Distributed Cisco ISE Deployments 46

Cisco ISE Distributed Deployment 46

 Cisco ISE Deployment Setup 46

 Data Replication from Primary to Secondary ISE Nodes 47

 Cisco ISE Node Deregistration 47

 Guidelines for Setting Up a Distributed Deployment 47

 Menu Options Available on Primary and Secondary Nodes 48

Configure a Cisco ISE Node 49

 Configure a Primary Policy Administration Node (PAN) 50

 Install Trusted Certificates for Cisco ISE Inter Node Communication 50

 Register a Secondary Cisco ISE Node 51

Administration Node 53

 High Availability for the Administrative Node 53

 High-Availability Health Check Nodes 54

 Health Check Nodes 55

 Automatic Failover to the Secondary PAN 55

 Sample Scenarios when Automatic Failover is Avoided 56

 Functionalities Affected by the PAN Automatic Failover Feature 57

 Configure Primary PAN for Automatic Failover 58

 Manually Promote Secondary PAN to Primary 59

 Restoring Service to the Primary PAN 60

Policy Service Node 60

High Availability in Policy Service Nodes	60
Load Balancer to Distribute Requests Evenly Among PSNs	61
Session Failover in Policy Service Nodes	61
Number of Nodes in a Policy Service Node Group	61
Monitoring Node	61
Manually Modify the MnT Role	62
Automatic Failover in MnT Nodes	62
Cisco pxGrid Node	63
Cisco pxGrid Client and Capability Management	65
Enable pxGrid Service	65
Enable pxGrid Capabilities	66
Deploy Cisco pxGrid Node	66
Cisco pxGrid Live Logs	66
Configure Cisco pxGrid Settings	67
Generate Cisco pxGrid Certificate	67
View Nodes in a Deployment	69
Synchronize Primary and Secondary Cisco ISE Nodes	69
Change Node Personas and Services	69
Effects of Modifying Nodes in Cisco ISE	70
Create a Policy Service Node Group	70
Configure MnT Nodes for Automatic Failover	71
Remove a Node from Deployment	72
Shut Down a Cisco ISE Node	73
Change the Hostname or IP Address of a Standalone Cisco ISE Node	73
Replace the Cisco ISE Appliance Hardware	74

PART III
Setup Cisco ISE Management Access 75

CHAPTER 5
Administer Cisco ISE 77

Administrator Access Console	77
Administrator Login Browser Support	78
Administrator Lockout Because of Login Attempts	78
Configure Proxy Settings in Cisco ISE	78
Ports Used by the Administration Portal	79

Enable External RESTful Services Application Programming Interface	79
External RESTful Services Software Development Kit	80
Specify System Time and Network Time Protocol Server Settings	80
Change the System Time Zone	81
Configure SMTP Server to Support Notifications	82
Cisco ISE Deployment Upgrade	82
Different Types of Deployment	83
Upgrade a Distributed Deployment	83
Cisco ISE Software Patches	86
Software Patch Installation Guidelines	87
Install a Software Patch	87
Roll Back Software Patches	88
Software Patch Rollback Guidelines	88
View Patch Install and Rollback Changes	89
Federal Information Processing Standards Mode Support	89
Enable Federal Information Processing Standards Mode in Cisco ISE	90
Configure Cisco ISE for Administrator Common Access Card Authentication	90
Cisco NAC Agent Requirements When FIPS Mode Is Enabled	93
Secure SSH Key Exchange Using Diffie-Hellman Algorithm	93
Configure Cisco ISE to Send Secure Syslog	93
Configure Secure Syslog Remote Logging Target	94
Enable Logging Categories to Send Auditable Events to the Secure Syslog Target	94
Disable TCP Syslog and UDP Syslog Collectors	95
Default Secure Syslog Collector	95
Offline Maintenance	96

CHAPTER 6**Manage Administrators and Admin Access Policies 97**

Cisco ISE Administrators	97
Privileges of a CLI Administrator Versus a Web-Based Administrator	98
Create a New Administrator	98
Cisco ISE Administrator Groups	99
Create an Admin Group	106
Administrative Access to Cisco ISE	107
Role-Based Admin Access Control in Cisco ISE	108

Role-Based Permissions	108
RBAC Policies	108
Default Menu Access Permissions	109
Configure Menu Access Permissions	109
Prerequisites for Granting Data Access Permissions	109
Default Data Access Permissions	110
Configure Data Access Permissions	112
Configure Admin Access Policies	112
Administrator Access Settings	113
Configure Maximum Number of Concurrent Administrative Sessions and Login Banners	113
Allow Administrative Access to Cisco ISE from Select IP Addresses	114
Configure a Password Policy for Administrator Accounts	114
Configure Account Disable Policy for Administrator Accounts	115
Configure Session Timeout for Administrators	116
Terminate an Active Administrative Session	116
Change Administrator Name	116
Administrative Access to Cisco ISE Using an External Identity Store	117
External Authentication and Authorization	117
Configure Admin Access Using an External Identity Store for Authentication with Internal Authorization	119

CHAPTER 7

Cisco ISE Licenses	121
Cisco ISE Licenses	121
Cisco ISE Smart Licensing	122
Activate and Register Smart Licensing in Cisco ISE	123
Smart Licensing for Air-Gapped Networks	125
Configure Smart Software Manager On-Prem for Smart Licensing	125
Manage Smart Licensing in Cisco ISE	126
Manage Traditional License Files	127
Cisco ISE Licensing Model	127
Traditional License Consumption	131
View License Consumption	132
Unregistered License Consumption	132
Manage License Files	133

Register Licenses	133
Re-Host Licenses	134
Renew Licenses	134
Migrate and Upgrade Licenses	134
Remove Licenses	135

CHAPTER 8**Manage Certificates 137**

Certificate Management in Cisco ISE	137
Configure Certificates in Cisco ISE to Enable Secure Access	137
Certificate Usage	138
Certificate Matching in Cisco ISE	140
Validity of X.509 Certificates	140
Enable Public Key Infrastructure in Cisco ISE	140
Wildcard Certificates	142
Wildcard Certificate Support in Cisco ISE	142
Wildcard Certificates for HTTPS and Extensible Authentication Protocol Communication	143
Fully Qualified Domain Name in URL Redirection	143
Advantages of Using Wildcard Certificates	144
Disadvantages of Using Wildcard Certificates	144
Wildcard Certificate Compatibility	145
Certificate Hierarchy	145
System Certificates	146
View System Certificates	147
Import a System Certificate	148
Generate a Self-Signed Certificate	148
Edit a System Certificate	149
Delete a System Certificate	150
Export a System Certificate	151
Trusted Certificates Store	151
Certificates in Trusted Certificates Store	152
Trusted Certificate Naming Constraints	153
View Trusted Certificates	154
Change the Status of a Certificate in Trusted Certificates Store	154
Add a Certificate to Trusted Certificates Store	154

Edit a Trusted Certificate	154
Delete a Trusted Certificate	155
Export a Certificate from Trusted Certificates Store	155
Import a Root Certificate to Trusted Certificate Store	156
Trusted Certificate Import Settings	156
Certificate Chain Import	157
Certificate-Signing Requests	158
Create a Certificate-Signing Request and Submit it to a Certificate Authority	158
Bind a CA-Signed Certificate to a Certificate Signing Request	158
Export a Certificate-Signing Request	159
Set Up Certificates for Portal Use	160
Reassign Default Portal Certificate Group Tag to CA-Signed Certificate	160
Associate Portal Certificate Tag Before You Register a Node	161
User and Endpoint Certificate Renewal	162
Dictionary Attributes Used in Policy Conditions for Certificate Renewal	162
Authorization Policy Condition for Certificate Renewal	162
CWA Redirect to a Renew Certificate	162
Configure Cisco ISE to Allow Users to a Renew Certificate	162
Update the Allowed Protocol Configuration	163
Create an Authorization Policy Profile for CWA Redirection	163
Create an Authorization Policy Rule to Renew a Certificate	164
Enable BYOD Settings in Guest Portal	164
Certificate Renewal Fails for Apple iOS Devices	165
Cisco ISE CA Service	165
Cisco ISE CA Certificates Provisioned on Administration and Policy Service Nodes	165
Cisco ISE CA Chain Regeneration	167
Elliptical Curve Cryptography Certificates Support	167
Cisco ISE Certificate Authority Certificates	169
Edit a Cisco ISE CA Certificate	169
Export a Cisco ISE CA Certificate	169
Import a Cisco ISE CA Certificate	170
Certificate Templates	170
Certificate Template Name Extension	170
Use Certificate Template Name in Authorization Policy Conditions	171

Deploy Cisco ISE CA Certificates for pxGrid Controller	171
Simple Certificate Enrollment Protocol Profiles	172
Issued Certificates	172
Backup and Restoration of Cisco ISE CA Certificates and Keys	173
Export Cisco ISE CA Certificates and Keys	173
Import Cisco ISE CA Certificates and Keys	174
Generate Root CA and Subordinate CAs on the Primary PAN and PSN	175
Configure Cisco ISE Root CA as Subordinate CA of an External PKI	175
Configure Cisco ISE to Use Certificates for Authenticating Personal Devices	176
Add Users to Employee User Group	177
Create a Certificate Authentication Profile for TLS-Based Authentication	177
Create an Identity Source Sequence for TLS-Based Authentication	178
Configure Certificate Authority Settings	178
Create a CA Template	179
Create a Native Supplicant Profile to be Used in Client-Provisioning Policy	181
Download Agent Resources from Cisco for Windows and MAC OS X Operating Systems	181
Create Client-Provisioning Policy Rules for Apple iOS, Android, and MAC OS X Devices	182
Configure the Dot1X Authentication Policy Rule for TLS-Based Authentication	182
Create Authorization Profiles for Central Web Authentication and Supplicant-Provisioning Flows	183
Create Authorization Policy Rules	184
CA Service Policy Reference	184
Client-Provisioning Policy Rules for Certificate Services	184
Authorization Profiles for Certificate Services	185
Authorization Policy Rules for Certificate Services	186
Cisco ISE CA Issues Certificates to ASA VPN Users	187
VPN Connection Certificate-Provisioning Flow	188
Configure Cisco ISE CA to Issue Certificates to ASA VPN Users	189
Revoke an Endpoint Certificate	191
OCSP Services	192
Cisco ISE CA Service Online Certificate Status Protocol Responder	192
OCSP Certificate Status Values	193
OCSP High Availability	193
OCSP Failures	193

Add OCSP Client Profiles	194
OCSP Statistics Counters	194
Requirements for CA to Interoperate with Cisco ISE	195

CHAPTER 9**Control Device Administration Using TACACS+ 199**

TACACS+ Device Administration	199
Access the Command-Line Interface to Change the Enable Password	200
Device Administration Work Center	201
Data Migration from Cisco Secure ACS to Cisco ISE	201
Device Administration Deployment Settings	202
Device Admin Policy Sets	202
TACACS+ Authentication Settings and Shared Secret	203
Device Administration - Authorization Policy Results	204
Allowed Protocols in FIPS and Non-FIPS Modes for TACACS+ Device Administration	204
TACACS+ Command Sets	205
Wildcards and Regex in Command Sets	205
Command Line and Command Set List Match	205
Process Rules with Multiple Command Sets	206
TACACS+ Profile	207
Common Tasks Settings	207
Create TACACS+ Command Sets	209
Create TACACS+ Profiles	210
Create Device Administration Policy Sets	210
Monitor Device Administration Activity	212
Configure Global TACACS+ Settings	212

CHAPTER 10**Manage Network Devices 213**

Defining Network Devices in Cisco ISE	213
Support for Session Aware Networking (SANet)	214
Define a Default Network Device in Cisco ISE	215
Add a Network Device in Cisco ISE	215
Import Network Devices into Cisco ISE	216
Export Network Devices from Cisco ISE	216
Third-Party Network Device Support in Cisco ISE	217

Network Device Profiles	220
Configure a Third-Party Network Device in Cisco ISE	221
Create a Network Device Profile	222
Export Network Device Profiles from Cisco ISE	223
Import Network Device Profiles into Cisco ISE	224
Network Device Groups	224
Network Device Attributes Used by Cisco ISE in Policy Evaluation	225
Import Network Device Groups into Cisco ISE	226
Export Network Device Groups from Cisco ISE	226
Import Templates in Cisco ISE	226
Network Devices Import Template Format	227
Network Device Groups Import Template Format	230
IPsec Security to Secure Communication Between Cisco ISE and NAD	231
Configure RADIUS IPsec on Cisco ISE	231
Configure and Install X.509 Certificates on ESR-5921	235
Example: Output of Pre-shared Key Configuration on Cisco Catalyst 3850 Series Switches	240
Mobile Device Manager Interoperability with Cisco ISE	241
Supported Mobile Device Management Use Cases	242
Supported Unified Endpoint Management and Mobile Device Management Servers	245
Ports Used by the Mobile Device Management Server	246
Mobile Device Management Integration Process Flow	246
Set Up Mobile Device Management Servers with Cisco ISE	248
Import Mobile Device Management Server Certificate into Cisco ISE	248
Define Device Management Servers in Cisco ISE	248
Define Microsoft System Center Configuration Manager Servers in Cisco ISE	249
Configure Mobile Device Management Servers in Cisco ISE	249
Cisco ISE Mobile Device Management Support for Microsoft Intune and Microsoft System Center Configuration Manager	252
Policy Set Example for Microsoft System Center Configuration Manager	253
Configure the Microsoft System Center Configuration Manager Server for Cisco ISE	254
Set Permissions when Microsoft Active Directory Users are in Domain Admin Group	254
Permissions for Microsoft Active Directory Users Not in Domain Admin Group	255
Permissions to Use DCOM on the Domain Controller	256
Set Permissions for Access to WMI Root and CIMv2 Namespace	258

Open Firewall Ports for WMI Access	259
Configure an Authorization Profile for Redirecting Nonregistered Devices	260
Configure Authorization Policy Rules for the Mobile Device Management Use Cases	260
Wipe or Lock a Device	261
View Mobile Device Management Reports	262
View Mobile Device Management Logs	262

CHAPTER 11**Manage Resources 263**

Dictionaries and Dictionary Attributes	263
System Defined Dictionaries and Dictionary Attributes	263
Display System Dictionaries and Dictionary Attributes	264
User-Defined Dictionaries and Dictionary Attributes	264
Create User-Defined Dictionaries	264
Create User-Defined Dictionary Attributes	265
RADIUS-Vendor Dictionaries	265
Create RADIUS-Vendor Dictionaries	266
Create RADIUS-Vendor Dictionary Attributes	266
HP RADIUS IETF Service Type Attributes	266

CHAPTER 12**Logging Mechanism 269**

Cisco ISE Logging Mechanism	269
Configure Syslog Purge Settings	270
Cisco ISE System Logs	270
Configure Remote Syslog Collection Locations	270
Cisco ISE Message Codes	272
Set Severity Levels for Message Codes	272
Cisco ISE Message Catalogs	272
Debug Logs	273
View Logging Components for a Node	273
Configure Debug Log Severity Level	273
Endpoint Debug Log Collector	274
Download Debug Logs for a Specific Endpoint	274
Collection Filters	275
Configure Collection Filters	275

Event Suppression Bypass Filter 275

CHAPTER 13

Backup and Restore Operations 277

Backup Data Type 277

Backup and Restore Repositories 278

Create Repositories 278

Enable RSA Public Key Authentication in SFTP Repository 280

On-Demand and Scheduled Backups 280

Perform an On-Demand Backup 281

Schedule a Backup 283

Backup Using the CLI 284

Backup History 284

Backup Failures 285

Cisco ISE Restore Operation 285

Guidelines for Data Restoration 285

Restoration of Configuration or Monitoring (Operational) Backup from the CLI 287

Restore Configuration Backups from the GUI 289

Restoration of Monitoring Database 290

Restore a Monitoring (Operational) Backup in a Standalone Environment 290

Restore a Monitoring Backup with Administration and Monitor Personas 290

Restore a Monitoring Backup with a Monitoring Persona 291

Restore History 292

Export Authentication and Authorization Policy Configuration 292

Synchronize Primary and Secondary Nodes in a Distributed Environment 292

Recovery of Lost Nodes in Standalone and Distributed Deployments 293

Recovery of Lost Nodes Using Existing IP Addresses and Hostnames in a Distributed Deployment 293

Recovery of Lost Nodes Using New IP Addresses and Hostnames in a Distributed Deployment 294

Recovery of a Node Using Existing IP Address and Hostname in a Standalone Deployment 294

Recovery of a Node Using New IP Address and Hostname in a Standalone Deployment 295

Configuration Rollback 295

Recovery of Primary Node in Case of Failure in a Distributed Deployment 296

Recovery of Secondary Node in Case of Failure in a Distributed Deployment 296

CHAPTER 14

Setup Adaptive Network Control 299

Enable Adaptive Network Control in Cisco ISE	299
Configure Network Access Settings	299
Quarantined Endpoints Do Not Renew Authentication Following Policy Change	300
Adaptive Network Control	301
Create Authorization Profiles for Network Access through ANC	302
Create Exception Policies for Network Access through ANC	302
ANC Operations Fail when IP Address or MAC Address is not Found	303
Externally Authenticated Administrators Cannot Perform ANC Operations	303
ANC Quarantine and Unquarantine Flow	303
ANC NAS Port Shutdown Flow	304
Endpoints Purge Settings	305
<hr/>	
PART IV	Manage Users and End-User Portals 307
<hr/>	
CHAPTER 15	Manage Users and External Identity Sources 309
Cisco ISE Users	309
User Identity	310
User Groups	310
User Identity Groups	310
User Role	310
User Account Custom Attributes	310
User Authentication Settings	311
Generate Automatic Password for Users and Administrators	313
To Add Users	313
Export Cisco ISE User Data	314
Import Cisco ISE Internal Users	314
Create a User Identity Group	315
Export User Identity Groups	315
Import User Identity Groups	315
Create Authorization Policy Using External Identity Sources	316
Configure Maximum Concurrent Sessions	316
Disable Individual User Accounts	318
Disable User Accounts Globally	318
Internal and External Identity Sources	319

Create an External Identity Source	321
Authenticate Internal Users Against External Identity Store Password	321
Certificate Authentication Profiles	322
Add a Certificate Authentication Profile	322
Active Directory as an External Identity Source	323
Active Directory-Supported Authentication Protocols and Features	323
Active Directory Attribute and Group Retrieval for Use in Authorization Policies	324
Support for Boolean Attributes	325
Active Directory Certificate Retrieval for Certificate-Based Authentication	325
Active Directory User Authentication Process Flow	326
Support for Active Directory Multidomain Forests	326
Prerequisites for Integrating Active Directory and Cisco ISE	326
Active Directory Account Permissions Required to Perform Various Operations	327
Network Ports that Must Be Open for Communication	328
DNS Server	328
Configure Active Directory as an External Identity Source	329
Add an Active Directory Join Point and Join Cisco ISE Node to the Join Point	329
Add Domain Controllers	331
Configure WMI for Passive ID	331
Leave the Active Directory Domain	333
Configure Authentication Domains	333
Configure Active Directory User Groups	334
Configure Active Directory User and Machine Attributes	335
Modify Password Changes, Machine Authentications, and Machine Access Restriction Settings	335
Machine Access Restriction Cache	336
Configure Custom Schema	336
Support for Active Directory Multijoin Configuration	337
Create a New Scope to Add Active Directory Join Points	338
Identity Rewrite	338
Enable Identity Rewrite	339
Identity Resolution Settings	339
Avoid Identity Resolution Issues	340
Configure Identity Resolution Settings	340
Test Users for Active Directory Authentication	341

Delete Active Directory Configurations	341
View Active Directory Joins for a Node	342
Diagnose Active Directory Problems	342
Enable Active Directory Debug Logs	343
Obtain the Active Directory Log File for Troubleshooting	343
Active Directory Alarms and Reports	343
Active Directory Advanced Tuning	344
Active Directory Identity Search Attributes	344
Supplemental Information for Setting Up Cisco ISE with Active Directory	345
Configure Group Policies in Active Directory	345
Configure Odyssey 5.X Supplicant for EAP-TLS Machine Authentications Against Active Directory	346
AnyConnect Agent for Machine Authentication	346
Active Directory Requirements to Support Easy Connect and Passive Identity services	347
Configure Active Directory for Passive Identity service	347
Set the Windows Audit Policy	350
Set Permissions when Microsoft Active Directory Users are in Domain Admin Group	351
Permissions for Microsoft Active Directory Users Not in Domain Admin Group	351
Permissions to Use DCOM on the Domain Controller	353
Set Permissions for Access to WMI Root and CIMv2 Namespace	354
Grant Access to the Security Event Log in the AD Domain Controller	355
Easy Connect	357
Configure Easy Connect Enforcement Mode	359
Configure Easy Connect Visibility Mode	360
PassiveID Work Center	361
Initial Setup and Configuration	362
PassiveID Work Center Dashboard	362
Active Directory as a Probe and a Provider	363
Getting Started with the PassiveID Setup	364
Manage the Active Directory Provider	366
Active Directory Settings	366
Additional Passive Identity Service Providers	369
Active Directory Agents	371
Automatically Install and Deploy Active Directory Agents	372

Manually Install and Deploy Active Directory Agents	373
Uninstall the Agent	374
Active Directory Agent Settings	374
API Providers	375
Configure a Bridge to the ISE REST Service for Passive Identity Services	377
Send API Calls to the Passive ID REST Service	377
API Provider Settings	378
API Calls	378
SPAN	380
Working with SPAN	380
SPAN Settings	381
Syslog Providers	382
Configure Syslog Clients	383
Customize Syslog Message Structures (Templates)	387
Work with Syslog Predefined Message Templates	392
Filter Passive Identity Services	403
Endpoint Probe	404
Work with the Endpoint Probe	405
Endpoint Probe Settings	405
Subscribers	406
Generate pxGrid Certificates for Subscribers	407
Enable Subscribers	408
View Subscriber Events from Live Logs	408
Configure Subscriber Settings	409
Monitoring and Troubleshooting Service in PassiveID Work Center	409
LDAP	409
LDAP Directory Service	409
Multiple LDAP Instances	410
LDAP Failover	410
LDAP Connection Management	410
LDAP User Authentication	411
LDAP Group and Attribute Retrieval for Use in Authorization Policies	412
Errors Returned by the LDAP Server	413
LDAP User Lookup	414

LDAP MAC Address Lookup	414
Add LDAP Identity Sources	414
Configure LDAP Schema	415
Configure Primary and Secondary LDAP Servers	415
Enable Cisco ISE to Obtain Attributes from the LDAP Server	415
Retrieve Group Membership Details from the LDAP Server	416
Retrieve User Attributes from the LDAP Server	416
Enable Secure Authentication with LDAP Identity Source	417
ODBC Identity Source	417
Credential Check for ODBC Database	418
Add ODBC Identity Source	422
RADIUS Token Identity Sources	423
RADIUS Token Server-Supported Authentication Protocols	423
Ports Used by the RADIUS Token Servers for Communication	424
RADIUS Shared Secret	424
Failover in RADIUS Token Servers	424
Configurable Password Prompt in RADIUS Token Servers	424
RADIUS Token Server User Authentication	424
User Attribute Cache in RADIUS Token Servers	424
RADIUS Identity Source in Identity Sequence	425
RADIUS Server Returns the Same Message for All Errors	425
Safeword Server Supports Special Username Format	425
Authentication Request and Response in RADIUS Token Servers	426
Add a RADIUS Token Server	426
Delete a RADIUS Token Server	427
RSA Identity Sources	428
Cisco ISE and RSA SecurID Server Integration	428
RSA Configuration in Cisco ISE	428
RSA Agent Authentication Against the RSA SecurID Server	428
RSA Identity Sources in a Distributed Cisco ISE Environment	429
RSA Server Updates in a Cisco ISE Deployment	429
Override Automatic RSA Routing	429
RSA Node Secret Reset	429
RSA Automatic Availability Reset	429

Add RSA Identity Sources	430
Import the RSA Configuration File	430
Configure the Options File for a Cisco ISE Server and Resetting SecurID and sdstatus.12 Files	430
Configure Authentication Control Options for RSA Identity Source	431
Configure RSA Prompts	431
Configure RSA Messages	432
SAMLv2 Identity Provider as an External Identity Source	432
Add an SAML Identity Provider	433
Delete an Identity Provider	436
Authentication Failure Log	436
Identity Source Sequences	437
Create Identity Source Sequences	437
Delete Identity Source Sequences	438
Identity Source Details in Reports	438
Authentications Dashlet	438
Identity Source Reports	439

CHAPTER 16
Configure Guest Access 441

Cisco ISE Guest Services	441
End-User Guest and Sponsor Portals in Distributed Environment	441
Guest and Sponsor Accounts	442
Guest Types and User Identity Groups	442
Create or Edit a Guest Type	443
Disable a Guest Type	445
Configure Maximum Simultaneous Logins for Endpoint Users	446
Schedule When to Purge Expired Guest Accounts	447
Add Custom Fields for Guest Account Creation	447
Specify Email Addresses and SMTP Servers for Email Notifications	448
Assign Guest Locations and SSIDs	448
Rules for Guest Password Policies	449
Set the Guest Password Policy and Expiration	450
Rules for Guest Username Policies	450
Set the Guest Username Policy	450
SMS Providers and Services	451

Configure SMS Gateways to Send SMS Notifications to Guests	451
Guest Portals	452
Credentials for Guest Portals	452
Guest Access with Hotspot Guest Portals	453
Guest Access with Credentialed Guest Portals	453
Employee Access with Credentialed Guest Portals	454
Guest Device Compliance	454
Guest Portals Configuration Tasks	454
Enable Policy Services	455
Add Certificates for Guest Portals	456
Create External Identity Sources	456
Create Identity Source Sequences	457
Create Endpoint Identity Groups	457
Create a Hotspot Guest Portal	458
Create a Sponsored-Guest Portal	459
Create a Self-Registered Guest Portal	460
Authorize Portals	461
Customize Guest Portals	463
Configure Periodic AUP Acceptance	463
Sponsor Portals	463
Managing Guest Accounts on the Sponsor Portal	463
Managing Sponsor Accounts	465
Configure Account Content for Sponsor Account Creation	469
Configure a Sponsor Portal Flow	469
Enable Policy Services	470
Add Certificates for Guest Services	470
Create External Identity Sources	470
Create Identity Source Sequences	471
Create a Sponsor Portal	472
Customize Sponsor Portals	472
Configuring Account Content for Sponsor Account Creation	472
Configuring the Time Settings Available to Sponsors	473
Sponsors Cannot Log In to the Sponsor Portal	474
Monitor Guest and Sponsor Activity	475

Metrics Dashboard	475
AUP Acceptance Status Report	475
Guest Accounting Report	475
Master Guest Report	475
Sponsor Login and Audit Report	476
Audit Logging for Guest and Sponsor Portals	476
Guest Access Web Authentication Options	476
NAD with Central WebAuth Process	477
Wireless LAN Controller with Local WebAuth Process	478
Wired NAD with Local WebAuth Process	479
IP Address and Port Values Required for the Login.html Page	480
HTTPS Server Enabled on the NAD	480
Support for Customized Authentication Proxy Web Pages on the NAD	480
Configure Web Authentication on the NAD	480
Device Registration WebAuth Process	481

CHAPTER 17
Support Device Access 483

Personal Devices on a Corporate Network (BYOD)	483
End-User Device Portals in a Distributed Environment	483
Global Settings for Device Portals	484
Personal Device Portals	484
Access Device Portals	485
Blacklist Portal	485
Certificate Provisioning Portal	485
Bring Your Own Device Portal	485
Client Provisioning Portal	486
Mobile Device Management Portal	486
My Devices Portal	487
BYOD Deployment Options and Status Flow	487
Limit the Number of Personal Devices Registered by Employees	490
Support Device Registration Using Native Supplicants	490
Operating Systems Supported by Native Supplicants	491
Allow Employees to Register Personal Devices Using Credentialed Guest Portals	491
Provide a URL to Reconnect with BYOD Registration	491

Device Portals Configuration Tasks	492
Enable Policy Services	493
Add Certificates to the Device Portal	493
Create External Identity Sources	494
Create Identity Source Sequences	494
Create Endpoint Identity Groups	495
Edit the Blacklist Portal	495
Create a BYOD Portal	497
Create a Certificate Provisioning Portal	499
Create a Client Provisioning Portal	500
Create an MDM Portal	501
Create a My Devices Portal	503
Create Authorization Profiles	504
Create Authorization Profiles	504
Create Authorization Policy Rules	504
Customize Device Portals	505
Manage Personal Devices Added by Employees	505
Display Devices Added by an Employee	505
Errors When Adding Devices to My Devices Portal	506
Devices Deleted from My Devices Portal Remain in Endpoints Database	506
Limit the Number of Personal Devices Registered by Employees	506
Monitor My Devices Portals and Endpoints Activity	506
My Devices Login and Audit Report	507
Registered Endpoints Report	507
<hr/>	
CHAPTER 18	Customize End-User Web Portals 509
End-User Portals	509
Customization of End-User Web Portals	509
Portal Content Types	512
Basic Customization of Portals	513
Modify the Portal Theme Colors	513
Change the Portal Display Language	514
Change the Portal Icons, Images, and Logos	515
Update the Portal Banner and Footer Elements	515

Change the Titles, Instructions, Buttons, and Label Text	516
Format and Style Text Box Content	516
Variables for Portal Pages Customization	517
View Your Customization	520
Custom Portal Files	520
Advanced Customization of Portals	521
Enable Advanced Portal Customization	521
Portal Theme and Structure CSS Files	522
About Changing Theme Colors with jQuery Mobile	522
Change Theme Colors with jQuery Mobile	524
Location Based Customization	525
User Device Type Based Customization	525
Export a Portal's Default Theme CSS File	526
Create a Custom Portal Theme CSS File	526
Embed Links in Portal Content	527
Insert Variables for Dynamic Text Updates	527
Use Source Code to Format Text and Include Links	528
Add an Image as an Advertisement	529
Set Up Carousel Advertising	530
Customize Greetings Based on Guest Location	532
Customize Greetings Based on User Device Type	533
Modify the Portal Page Layout	534
Import the Custom Portal Theme CSS File	536
Delete a Custom Portal Theme	537
View Your Customization	537
Portal Language Customization	538
Export the Language File	539
Add or Delete Languages from the Language File	540
Import the Updated Language File	541
Customization of Guest Notifications, Approvals, and Error Messages	541
Customize Email Notifications	541
Customize SMS Text Message Notifications	542
Customize Print Notifications	543
Customize Approval Request Email Notifications	543

Edit Error Messages 544

PART V**Enable and Configure Cisco ISE Services 545**

CHAPTER 19**Set Up Policy Conditions 547**

Policy Conditions 547

Simple and Compound Conditions 547

Policy Evaluation 548

Create Simple Conditions 548

Create Compound Conditions 549

Profiler Conditions 550

 Create a Profiler Condition 550

Posture Conditions 551

 Simple Posture Conditions 551

 Create Simple Posture Conditions 552

 Compound Posture Conditions 552

 Predefined Condition for Enabling Automatic Updates in Windows Clients 552

 Preconfigured Antivirus and Antispyware Conditions 552

 Antivirus and Antispyware Support Chart 553

 Compliance Module 553

 Create Compound Posture Conditions 554

Create Patch Management Conditions 555

Create Disk Encryption Conditions 556

Network Conditions 556

 Configure Endstation Network Conditions 557

 Configure Device Network Conditions 558

 Configure Device Port Network Condition 558

Create Time and Date Conditions 558

CHAPTER 20**Manage Authentication Policies 561**

Cisco ISE Authentication Policies 561

 Policy Condition Evaluation 562

 Supported Authentication Protocols 562

 Supported Authentication Types and Database 562

Types of Authentication Failures—Failovers	563
Authentication Policy Terminology	564
Simple Authentication Policies	564
Simple Authentication Policy Flow	565
Guidelines for Configuring Simple Authentication Policies	566
Rule-Based Authentication Policies	566
Rule-Based Authentication Policy Flow	566
Supported Dictionaries for Rule-Based Authentication Policies	567
Attributes Supported by Dictionaries	568
Protocol Settings for Authentication	571
Guidelines for Using EAP-FAST as Authentication Protocol	571
Configure EAP-FAST Settings	572
Generate the PAC for EAP-FAST	572
Using EAP-TTLS as Authentication Protocol	572
Configure EAP-TTLS Settings	573
Configure EAP-TLS Settings	573
Configure PEAP Settings	574
Configure RADIUS Settings	574
Configure Security Settings	574
Network Access Service	575
Define Allowed Protocols for Network Access	576
Enable MAB from Non-Cisco Devices	577
Enable MAB from Cisco Devices	578
Network Access Work Center	579
Cisco ISE Acting as a RADIUS Proxy Server	579
Configure External RADIUS Servers	580
Define RADIUS Server Sequences	580
Cisco ISE Acting as a TACACS+ Proxy Client	581
TACACS+ External Server Settings	581
Configure External TACACS+ Servers	582
TACACS+ Server Sequence Settings	583
Define TACACS+ Server Sequences	584
Location Based Authorization	585
Add an MSE server	585

Location Tree	586
Policy Modes	586
Change Policy Modes	587
Configure a Simple Authentication Policy	587
Configure a Rule-Based Authentication Policy	588
Default Authentication Policy	589
Policy Sets	590
Policy Set Evaluation Flow	591
Guidelines for Creating Policy Sets	591
Global Authorization Exception Policy	592
Configure Policy Sets	592
Authentication Policy Built-In Configurations	592
View Authentication Results	595
Authentication Dashlet	595
Authentication Reports and Troubleshooting Tools	596

CHAPTER 21

Manage Authorization Policies and Profiles	597
Cisco ISE Authorization Policies	597
Cisco ISE Authorization Profiles	597
Authorization Policy Terminology	598
Network Authorization	598
Policy Elements	598
Authorization Profile	599
Authorization Policy	599
Access Control Lists	600
Authorization Policies and Supported Dictionaries	600
Guidelines for Configuring Authorization Policies and Profiles	600
Default Authorization Policy, Rule, and Profile Configuration	601
Default Authorization Rules	605
Configure Authorization Policies	605
Authorization Policy Attributes and Conditions	606
Time and Date Conditions	607
Use IPv6 Condition Attributes in Authorization Policies	607
Permissions for Authorization Profiles	609

Configure Permissions for New Standard Authorization Profiles	610
Downloadable ACLs	610
Configure Permissions for Downloadable ACLs	610
Machine Access Restriction for Active Directory User Authorization	611

CHAPTER 22

Configure Threat Centric NAC Service	613
Threat Centric NAC Service	613
Enable Threat Centric NAC Service	616
Add SourceFire FireAMP Adapter	616
Configure Cognitive Threat Analytics Adapter	617
Configure Authorization Profiles for CTA Adapter	618
Configure Authorization Policy using the Course of Action Attribute	618
Support for Vulnerability Assessment in Cisco ISE	619
Enable and Configure Vulnerability Assessment Service	620
Enable Threat Centric NAC Service	620
Configure Qualys Adapter	621
Configure Nexpose Adapter	623
Configure Tenable Adapter	625
Configure Authorization Profile	628
Configure Exception Rule to Quarantine a Vulnerable Endpoint	628
Vulnerability Assessment Logs	629

CHAPTER 23

Configure Smart Licensing and Smart Call Home Services	631
Smart Call Home	631
Smart Call Home Profiles	631
Anonymous Reporting	632
Register for Smart Call Home Service	632

CHAPTER 24

Cisco ISE Endpoint Profiling Policies	633
Cisco ISE Profiling Service	633
Profiler Work Center	634
Profiler Dashboard	634
Endpoint Inventory Using Profiling Service	634
Cisco ISE Profiler Queue Limit Configuration	635

Martian IP Addresses	635
Configure Profiling Service in Cisco ISE Nodes	636
Network Probes Used by Profiling Service	636
IP Address and MAC Address Binding	636
NetFlow Probe	637
DHCP Probe	637
Wireless LAN Controller Configuration in DHCP Bridging Mode	638
DHCP SPAN Probe	638
HTTP Probe	638
HTTP SPAN Probe	639
Unable to Collect HTTP Attributes in Cisco ISE Running on VMware	639
pxGrid Probe	639
RADIUS Probe	640
Network Scan (NMAP) Probe	641
SNMP Read Only Community Strings for NMAP Manual Subnet Scan	641
Manual NMAP Scan Results	642
DNS Probe	643
DNS FQDN Lookup	643
Configure Call Station ID Type in the WLC Web Interface	643
SNMP Query Probe	644
Cisco Discovery Protocol Support with SNMP Query	644
Link Layer Discovery Protocol Support with SNMP Query	644
SNMP Trap Probe	645
Active Directory Probe	646
Configure Probes for Each Cisco ISE Node	646
Setup CoA, SNMP RO Community, and Endpoint Attribute Filter	647
Global Configuration of Change of Authorization for Authenticated Endpoints	648
Use Cases for Issuing Change of Authorization	648
Exemptions for Issuing a Change of Authorization	649
Change of Authorization Issued for Each Type of CoA Configuration	650
Attribute Filters for ISE Database Persistence and Performance	650
Global Setting to Filter Endpoint Attributes	651
Attributes Collection from Cisco IOS Sensor-Embedded Switches	653
Cisco IOS Sensor-Embedded Network Access Devices	653

Configuration Checklist for Cisco IOS Sensor-Enabled Network Access Devices	653
Profiler Conditions	655
Profiling Network Scan Actions	655
Create a New Network Scan Action	656
NMAP Operating System Scan	656
Operating System Ports	657
NMAP SNMP Port Scan	660
NMAP Common Ports Scan	661
Common Ports	661
NMAP Custom Ports Scan	662
NMAP Include Service Version Information Scan	662
NMAP SMB Discovery Scan	663
Skip NMAP Host Discovery	663
NMAP Scan Workflow	663
Exclude Subnets from NMAP Scan	667
Manual NMAP Scan Settings	667
Configure Profiler Policies Using the McAfee ePolicy Orchestrator	668
Profiler Endpoint Custom Attributes	671
Create a Profiler Condition	672
Endpoint Profiling Policy Rules	672
Create Endpoint Profiling Policies	673
Change of Authorization Configuration for Each Endpoint Profiling Policy	674
Import Endpoint Profiling Policies	675
Export Endpoint Profiling Policies	676
Predefined Endpoint Profiling Policies	676
Predefined Endpoint Profiling Policies Overwritten During Upgrade	677
Unable to Delete Endpoint Profiling Policies	677
Predefined Profiling Policies for Draeger Medical Devices	677
Endpoint Profiling Policy for Unknown Endpoints	678
Endpoint Profiling Policy for Statically Added Endpoints	678
Endpoint Profiling Policy for Static IP Devices	678
Endpoint Profiling Policy Matching	678
Endpoint Profiling Policies Used for Authorization	679
Endpoint Profiling Policies Grouped into Logical Profiles	679

Create Logical Profiles	679
Profiling Exception Actions	680
Create Exception Actions	680
Create Endpoints with Static Assignments of Policies and Identity Groups	681
Import Endpoints Using a CSV File	681
Default Import Template Available for Endpoints	683
Unknown Endpoints Reprofiled During Import	683
Endpoints with Invalid Attributes Not Imported	683
Import Endpoints from LDAP Server	684
Export Endpoints Using CSV File	684
Identified Endpoints	685
Identified Endpoints Locally Stored in Policy Service Nodes Database	686
Policy Service Nodes in Cluster	686
Create Endpoint Identity Groups	687
Identified Endpoints Grouped in Endpoint Identity Groups	688
Default Endpoint Identity Groups Created for Endpoints	688
Endpoint Identity Groups Created for Matched Endpoint Profiling Policies	688
Add Static Endpoints in Endpoint Identity Groups	689
Dynamic Endpoints Reprofiled After Adding or Removing in Identity Groups	689
Endpoint Identity Groups Used in Authorization Rules	689
Profiler Feed Service	689
Configure Profiler Feed Service	690
Configure Profiler Feed Services Offline	691
Download Offline Update Package	692
Apply Offline Feed Updates	692
Configure Email Notifications for Profile and OUI Updates	692
Undo Feed Updates	693
Profiler Reports	693
Detect Anomalous Behavior of Endpoints	693
Set Authorization Policy Rules for Endpoints with Anomalous Behavior	694
View Endpoints with Anomalous Behavior	694
Cisco ISE Integration with Cisco NAC Appliance	695
Cisco Clean Access Manager Configuration in Administration Nodes	695
Cisco ISE Profiler and Cisco Clean Access Manager Communication	695

Add Cisco Clean Access Managers	696
Create Endpoints with Static Assignments of Policies and Identity Groups	697
Import Endpoints Using a CSV File	697
Default Import Template Available for Endpoints	698
Unknown Endpoints Reprofiled During Import	699
Endpoints with Invalid Attributes Not Imported	699
Import Endpoints from LDAP Server	700
Export Endpoints Using CSV File	700
Identified Endpoints	701
Identified Endpoints Locally Stored in Policy Service Nodes Database	702
Policy Service Nodes in Cluster	702
Create Endpoint Identity Groups	703
Anycast and Profiler Services	705
<hr/>	
CHAPTER 25	Configure Client Provisioning 707
Configure Client Provisioning in Cisco ISE	707
Client Provisioning Resources	708
Add Client Provisioning Resources from Cisco	709
Add Cisco Provided Client Provisioning Resources from a Local Machine	710
Add Customer Created Resources for AnyConnect from a Local Machine	710
Create Native Supplicant Profiles	711
Native Supplicant Profile Settings	712
Client Provisioning Without URL Redirection for Different Networks	713
AMP Enabler Profile Settings	714
Create an AMP Enabler Profile Using the Embedded Profile Editor	715
Create an AMP Enabler Profile Using the Standalone Editor	716
Troubleshoot Common AMP Enabler Installation Errors	717
Cisco ISE Support for Onboarding Chromebook Devices	717
Best Practices for Using Chromebook Device in a Shared Environment	719
Chromebook Onboarding Process	719
Configure the Network and Force Extensions in the Google Admin Console	720
Configure Cisco ISE for Chromebook Onboarding	721
Wipe a Chromebook Device	722
Enroll Chromebook to the Google Admin Console	722

Connect Chromebook to the Cisco ISE Network for BYOD On Boarding	723
Google Admin Console - Wi-Fi Network Settings	724
Monitor Chromebook Device Activities in Cisco ISE	728
Troubleshoot Chromebook Device Onboarding	728
Create AnyConnect Configuration	729
Create a Posture Agent Profile	730
Client IP Address Refresh Configuration	730
Posture Protocol Settings	733
Client Login Session Criteria	733
Agent Download Issues on Client Machine	733
Provision Client Machines with the Cisco NAC Agent MSI Installer	734
Cisco ISE Posture Agents	735
Posture Agent Discovery Request and Cisco ISE Response	735
Web Agent Posture Discovery Request and Cisco ISE Response	736
Agent Displays “Temporary Access”	736
Agent Fails to Initiate Posture Assessment	736
Cisco AnyConnect Secure Mobility	737
Cisco NAC Agent XML File Installation Directories	737
Cisco NAC Agent for Windows Clients	737
Uninstall the Cisco NAC Agent from Windows 7 and Earlier Clients	738
Uninstall the Cisco NAC Agent in a Windows 8 Client	738
Windows 8 Metro and Metro App Support—Toast Notifications	738
Cisco NAC Agent for Macintosh Clients	739
Uninstall the Cisco NAC Agent from Macintosh Clients	739
Cisco Web Agent	739
Cisco NAC Agent Logs	740
Create an Agent Customization File for the Cisco NAC Agent	740
Custom nac_login.xml File Template	741
Custom nacStrings_xx.xml File Template	741
Sample Extended nacStrings_xx.xml File	751
UpdateFeed.xml Descriptor File Template	752
Example XML File Generated Using the Create Profile Function	752
Configure Client Provisioning Resource Policies	753
Configure Cisco ISE Posture Agent in the Client Provisioning Policy	754

Configure Native Supplicants for Personal Devices	755
Client Provisioning Reports	755
Client Provisioning Event Logs	756

CHAPTER 26

Configure Client Posture Policies 757

Posture Service	758
Components of Posture Services	758
Posture and Client-Provisioning Policies Workflow	760
Posture Service Licenses	760
Posture Service Deployment	760
Enable Posture Session Service in Cisco ISE	761
Run the Posture Assessment Report	761
Posture Administration Settings	761
Timer Settings for Clients	762
Set Remediation Timer for Clients to Remediate Within Specified Time	762
Set Network Transition Delay Timer for Clients to Transition	762
Set Login Success Window to Close Automatically	763
Set Posture Status for Nonagent Devices	763
Posture Lease	764
Periodic Reassessments	764
Configure Periodic Reassessments	765
Download Posture Updates to Cisco ISE	765
Download Posture Updates Automatically	766
Configure Acceptable Use Policies for Posture Assessment	767
Posture Conditions	767
Simple Posture Conditions	767
Create Simple Posture Conditions	768
Compound Posture Conditions	768
Predefined Condition for Enabling Automatic Updates in Windows Clients	769
Preconfigured Antivirus and Antispyware Conditions	769
Antivirus and Antispyware Support Chart	769
Compliance Module	770
Create Compound Posture Conditions	771
Create Patch Management Conditions	772

Create Disk Encryption Conditions	772
Configure Posture Policies	773
Configure AnyConnect Workflow	774
Posture Assessment Options	775
Posture Remediation Options	776
Custom Conditions for Posture	777
Custom Posture Remediation Actions	777
Add a File Remediation	777
Add a Link Remediation	778
Add a Patch Management Remediation	778
Add an Antivirus Remediation	778
Add an Antispyware Remediation	779
Add a Launch Program Remediation	779
Troubleshoot Launch Program Remediation	780
Add a Windows Update Remediation	780
Add a Windows Server Update Services Remediation	780
Posture Assessment Requirements	781
Client System Stuck in Noncompliant State	782
Create Client Posture Requirements	782
Custom Permissions for Posture	783
Configure Standard Authorization Policies	784
Stealth Mode Deployment	785
Impact of Stealth Mode on Posture Policy and Requirement Types	786
Best Practices for Network Drive Mapping with Posture	788
Configure AnyConnect Clientless Mode Workflow	788
Create an AnyConnect Agent Profile	789
Create an AnyConnect Configuration for AnyConnect Packages	789
Upload a Open DNS Profile in Cisco ISE	790
Create a Client Provisioning Policy	790
Create a Posture Condition	790
Create Posture Remediation	791
Create Posture Requirement in Clientless Mode	791
Create Posture Policy	791

CHAPTER 27	Cisco TrustSec Policies Configuration	793
	TrustSec Architecture	793
	TrustSec Components	794
	TrustSec Terminology	795
	Supported Switches and Required Components for TrustSec	796
	TrustSec Dashboard	796
	Metrics	797
	Current Network Status	797
	Active SGT Sessions	797
	Alarms	798
	Quick View	798
	Live Log	799
	Configure TrustSec Global Settings	799
	Configure TrustSec Matrix Settings	800
	Configure TrustSec Devices	800
	OOB TrustSec PAC	800
	Generate a TrustSec PAC from the Settings Screen	800
	Generate a TrustSec PAC from the Network Devices Screen	801
	Generate a TrustSec PAC from the Network Devices List Screen	801
	Configure Cisco TrustSec AAA Servers	802
	Security Groups Configuration	802
	Add Security Groups	803
	Import Security Groups into Cisco ISE	803
	Export Security Groups from Cisco ISE	804
	Add IP SGT Static Mapping	804
	Deploy IP SGT Static Mappings	805
	Import IP SGT Static Mappings into Cisco ISE	806
	Export IP SGT Static Mappings from Cisco ISE	806
	Add SGT Mapping Group	806
	Add Security Group Access Control Lists	807
	Egress Policy	809
	Source Tree View	809
	Destination Tree View	809

Matrix View	810
Matrix Dimensions	811
Import/Export Matrix	811
Create Custom View	811
Matrix Operations	811
Configure Work Process Settings	812
Matrices Listing Page	813
TrustSec Matrix Workflow Process	814
Egress Policy Table Cells Configuration	819
Add the Mapping of Egress Policy Cells	819
Export Egress Policy	820
Import Egress Policy	820
Configure SGT from Egress Policy	821
Monitor Mode	821
Features of Monitor Mode	822
The Unknown Security Group	822
Default Policy	822
Push Button	822
SGT Assignment	823
NDAC Authorization	823
Configure NDAC Authorization	824
Configure End User Authorization	824
TrustSec Configuration and Policy Push	825
CoA Supported Network Devices	825
Push Configuration Changes to Non-CoA Supporting Devices	825
SSH Key Validation	826
Environment CoA Notification Flow	827
Environment CoA Triggers	827
Update SGACL Content Flow	829
Initiate an Update SGACL Named List CoA	829
Policies Update CoA Notification Flow	830
Update SGT Matrix CoA Flow	830
Initiate Update SGT Matrix CoA from Egress Policy	831
TrustSec CoA Summary	831

Security Group Tag Exchange Protocol	833
Add an SXP Device	834
Add an SXP Domain Filter	834
Configure SXP Settings	835
TrustSec-Cisco ACI Integration	835
Configure Cisco ACI Settings	836
Run Top N RBACL Drops by User Report	838

PART VI
Monitoring and Troubleshooting Cisco ISE 839

CHAPTER 28
Monitoring and Troubleshooting 841

Monitoring and Troubleshooting Service in Cisco ISE	841
Cisco ISE Dashboard	842
Network Privilege Framework Event Flow Process	844
User Roles and Permissions for Monitoring and Troubleshooting Capabilities	845
Data Stored in the Monitoring Database	845
Device Configuration for Monitoring	845
Troubleshooting the Cisco AnyConnect Agent Download Issues	845
Troubleshooting the Profiler Feed	846
Posture Compliance	846
Check Posture Compliance	846
SNMP Traps to Monitor Cisco ISE	847
Cisco ISE Alarms	851
Alarm Settings	869
Add Custom Alarms	869
Cisco ISE Alarm Notifications and Thresholds	870
Enable and Configure Alarms	870
Cisco ISE Alarms for Monitoring	870
View Monitoring Alarms	871
Log Collection	871
Alarm Syslog Collection Location	871
Live Authentications	872
Monitor Live Authentications	872
Filter Data in the Live Authentications Page	873

Global Search for Endpoints	873
Session Trace for an Endpoint	875
Session Removal from the Directory	877
Authentication Summary Report	877
Troubleshoot Network Access Issues	878
Diagnostic Troubleshooting Tools	878
The RADIUS Authentication Troubleshooting Tool	878
Troubleshoot Unexpected RADIUS Authentication Results	878
The Execute Network Device Command Diagnostic Tool	879
Execute Cisco IOS show Commands to Check Configuration	879
The Evaluate Configuration Validator Tool	880
Troubleshoot Network Device Configuration Issues	880
Posture Troubleshooting Tool	880
Troubleshoot Endpoint Posture Failure	880
Session Trace Test Cases	880
Configure a Session Trace Test Case	881
Technical Support Tunnel for Advanced Troubleshooting	882
Establish a Technical Support Tunnel	882
TCP Dump Utility to Validate Incoming Traffic	883
Use TCP Dump to Monitor Network Traffic	883
Save a TCP Dump File	884
Compare Unexpected SGACL for an Endpoint or User	885
Egress Policy Diagnostic Flow	885
Troubleshoot Connectivity Issues in a Trustsec-Enabled Network with SXP-IP Mappings	885
Troubleshoot Connectivity Issues in a TrustSec-Enabled Network with IP-SGT Mappings	886
Device SGT Tool	886
Troubleshoot Connectivity Issues in a TrustSec-Enabled Network by Comparing Device SGT Mappings	886
Download Endpoint Statistical Data from MnT Nodes	887
Obtaining Additional Troubleshooting Information	887
Cisco ISE Support Bundle	887
Support Bundle	888
Download Cisco ISE Log Files	888
Cisco ISE Debug Logs	889

Obtain Debug Logs	890
Cisco ISE Components and Corresponding Debug Logs	890
Download Debug Logs	892
Monitoring Database	892
Back Up and Restore the Monitoring Database	893
Monitoring Database Purge	893
Guidelines for Purging the Monitoring Database	893
Operational Data Purging	894
Purge Older Operational Data	894
Database Crash or File Corruption Issues	895

CHAPTER 29**Reports 897**

Cisco ISE Reports	897
Report Filters	897
Create the Quick Filter Criteria	898
Create the Advanced Filter Criteria	898
Run and View Reports	899
Reports Navigation	899
Export Reports	900
Schedule and Save Cisco ISE Reports	901
Cisco ISE Active RADIUS Sessions	902
Change Authorization for RADIUS Sessions	903
Available Reports	903

PART VII**Reference 923****CHAPTER 30****Administration User Interface Reference 953**

Deployment and Node Settings	953
Deployment Nodes List Window	953
General Node Settings	955
Profiling Node Settings	960
Trusted Certificate Settings	962
Certificate Store Settings	965
Self-Signed Certificate Settings	965

Certificate-Signing Request Settings	966
Issued and Revoked Certificates	972
Certificate Periodic Check Settings	972
System Certificate Import Settings	973
List of Trusted Certificates	974
Trusted Certificate Import Settings	975
OCSP Client Profile Settings	976
Internal CA Settings	979
Certificate Template Settings	979
Logging Settings	980
Remote Logging Target Settings	980
Configure Logging Categories	982
Maintenance Settings	983
Repository Settings	984
On-Demand Backup Settings	985
Scheduled Backup Settings	985
Admin Access Settings	986
Administrator Password Policy Settings	986
Session Timeout and Session Information Settings	989
General TrustSec Settings	990
Settings	992
Posture General Settings	992
Posture Reassessment Configuration Settings	993
Posture Acceptable Use Policy Configuration Settings	995
EAP-FAST Settings	996
PAC Settings	997
EAP-TTLS Settings	999
EAP-TLS Settings	999
PEAP Settings	999
RADIUS Settings	999
TrustSec Matrix Settings	1002
SMS Gateway Settings	1003
DHCP and DNS Services	1005
Identity Management	1008

Endpoints	1008
Endpoint Settings	1009
Endpoint Import from LDAP Settings	1010
Endpoint Identity Group Settings	1012
External Identity Sources	1013
LDAP Identity Source Settings	1013
RADIUS Token Identity Sources Settings	1020
RSA SecurID Identity Source Settings	1021
Network Resources	1022
Support for Session Aware Networking (SAnet)	1022
Network Devices	1022
Network Device Definition Settings	1022
Default Network Device Definition Settings	1032
Device Security Settings	1035
Network Device Import Settings	1036
Manage Network Device Groups	1036
Network Device Group Settings	1036
Network Device Group Import Settings	1037
Network Device Profiles Settings	1038
External RADIUS Server Settings	1043
RADIUS Server Sequences	1045
NAC Manager Settings	1046
Device Portal Management	1047
Configure Device Portal Settings	1047
Global Settings for Device Portals	1047
Portal Identification Settings for Device Portals	1048
Portal Settings for the Blacklist Portal	1049
Portal Settings for BYOD and MDM Portals	1050
BYOD Settings for BYOD Portals	1052
Portal Settings for Certificate Provisioning Portal	1053
Portal Settings for Client Provisioning Portals	1056
Employee Mobile Device Management Settings for MDM Portals	1059
Portal Settings for My Devices Portals	1059
Login Page Settings for My Devices Portals	1062

Acceptable Use Policy Page Settings for My Devices Portals	1062
Post-Login Banner Page Settings for My Devices Portals	1062
Employee Change Password Settings for My Devices Portals	1063
Manage Device Settings for My Devices Portal	1063
Add, Edit, and Locate Device Customization for My Devices Portals	1064
Support Information Page Settings for Device Portals	1064

Guest Portal Settings 923

Portal Identification Settings	923
Portal Settings for Hotspot Guest Portals	924
Acceptable Use Policy (AUP) Page Settings for Hotspot Guest Portals	926
Post-Access Banner Page Settings for Hotspot Portals	927
Portal Settings for Credentialed Guest Portals	927
Login Page Settings for Credentialed Guest Portals	929
Self-Registration Page Settings	930
Self Registration Success Page Settings	933
Acceptable Use Policy (AUP) Page Settings for Credentialed Guest Portals	934
Guest Change Password Settings for Credentialed Guest Portals	934
Guest Device Registration Settings for Credentialed Guest Portals	934
BYOD Settings for Credentialed Guest Portals	935
Post-Login Banner Page Settings for Credentialed Guest Portals	936
Guest Device Compliance Settings for Credentialed Guest Portals	936
VLAN DHCP Release Page Settings for Guest Portals	937
Authentication Success Settings for Guest Portals	937
Support Information Page Settings for Guest Portals	938

Sponsor Portal Application Settings 939

Portal Identification Settings	939
Portal Settings for Sponsor Portals	940
Login Settings for Sponsor Portals	943
Acceptable Use Policy (AUP) Settings for Sponsor Portals	943
Sponsor Change Password Settings for Sponsor Portals	944
Post-Login Banner Settings for Sponsor Portals	944
Support Information Page Settings for Sponsor Portals	944

Notify Guests Customization for Sponsor Portals	945
Manage and Approve Customization for Sponsor Portals	946

Global Settings 946

Global Settings for Guest and Sponsor Portals	946
Guest Type Settings	947
Sponsor Group Settings	949

CHAPTER 31

Web Portals Customization Reference 1067

Portal Pages Titles, Content and Labels Character Limits	1067
Character Limits for Portal Pages Titles, Content and Labels	1067
Portal Customization	1069
CSS Classes and Descriptions for End-User Portals Page Layout	1069
HTML Support for a Portal Language File	1070
HTML Support for the Blacklist Portal Language File	1070
HTML Support for Bring Your Own Device Portals Language Files	1071
HTML Support for Certificate Provisioning Portal Language Files	1072
HTML Support for Client Provisioning Portal Language Files	1073
HTML Support for Credential Guest Portals Language Files	1074
HTML Support for Hotspot Guest Portals Language Files	1076
HTML Support for Mobile Device Management Portals Language Files	1077
HTML Support for My Devices Portals Language Files	1078
HTML Support for Sponsor Portals Language Files	1079

CHAPTER 32

Policy User Interface Reference 1081

Authentication	1081
Simple Authentication Policy Configuration Settings	1081
Rule-Based Authentication Policy Configuration Settings	1082
Authorization Policy Settings	1086
Endpoint Profiling Policies Settings	1087
Endpoint Context Visibility Using UDID Attribute	1092
RADIUS Vendor Dictionary Attribute Settings	1092
Conditions	1093
Profiler Condition Settings	1094

Posture Condition Settings	1094
File Condition Settings	1094
Firewall Condition Settings	1099
Registry Condition Settings	1099
Application Condition Settings	1100
Continuous Endpoint Attribute Monitoring	1101
Application Condition Settings	1101
Service Condition Settings	1103
Posture Compound Condition Settings	1104
AntiVirus Condition Settings	1105
Antispyware Compound Condition Settings	1107
Antimalware Condition Settings	1108
Dictionary Simple Condition Settings	1110
Dictionary Compound Condition Settings	1111
Patch Management Condition Settings	1112
Disk Encryption Condition Settings	1113
USB Condition Settings	1115
Time and Date Condition Settings	1115
Results	1116
Allowed Protocols	1116
PAC Options	1126
Authorization Profile Settings	1129
Profiling Exception Action Settings	1132
File Remediation	1133
Firewall Remediations	1134
Link Remediation	1135
Application Remediation	1136
Antimalware Remediation	1137
Antivirus Remediation	1138
Antispyware Remediation	1139
Launch Program Remediation	1140
Windows Update Remediation	1141
Windows Server Update Services Remediation	1143
Patch Management Remediation	1145

USB Mass Storage Check Workflow 1147

USB Mass Storage Remediation 1147

Client Posture Requirements 1148

CHAPTER 33

Operations User Interface Reference 1149

RADIUS Live Logs 1149

RADIUS Live Sessions 1152

TACACS Live Logs 1155

Diagnostic Tools 1157

RADIUS Authentication Troubleshooting Settings 1157

Execute Network Device Command Settings 1158

Evaluate Configuration Validator Settings 1159

Posture Troubleshooting Settings 1160

TCP Dump Settings 1161

SXP-IP Mappings 1162

IP User SGT 1163

Device SGT Settings 1164

Progress Details Settings 1165

Results Summary 1166

CHAPTER 34

Network Access Flows 1169

Password-Based Authentication 1169

Secure Authentication Using Encrypted Passwords and Cryptographic Techniques 1169

Authentication Methods and Authorization Privileges 1170

RADIUS Protocol Support in Cisco ISE 1170

Network Access for Users 1170

RADIUS-Based Protocols Without EAP 1170

RADIUS-Based Non-EAP Authentication Flow 1171

Password Authentication Protocol 1171

RADIUS-Based PAP Authentication in Cisco ISE 1171

Challenge Handshake Authentication Protocol 1172

Microsoft Challenge Handshake Authentication Protocol Version 1 1172

Microsoft Challenge Handshake Authentication Protocol Version 2 1172

RADIUS-Based EAP Protocols 1172

RADIUS-Based EAP Authentication Flow	1173
Extensible Authentication Protocol-Message Digest 5	1174
Lightweight Extensible Authentication Protocol	1174
Protected Extensible Authentication Protocol	1174
Advantages of Using PEAP	1174
Supported Supplicants for the PEAP Protocol	1174
PEAP Protocol Flow	1175
Extensible Authentication Protocol-Flexible Authentication via Secure Tunneling	1175
Benefits of EAP-FAST	1176
EAP-FAST Flow	1176

CHAPTER 35**Switch and Wireless LAN Controller Configuration Required to Support Cisco ISE Functions 1177**

Enable Your Switch to Support Standard Web Authentication	1177
Local Username and Password Definition for Synthetic RADIUS Transactions	1178
NTP Server Configuration to Ensure Accurate Log and Accounting Timestamps	1178
Command to Enable AAA Functions	1178
RADIUS Server Configuration on the Switch	1179
Command to Enable RADIUS Change of Authorization (CoA)	1179
Command to Enable Device Tracking and DHCP Snooping	1180
Command to Enable 802.1X Port-Based Authentication	1180
Command to Enable EAP for Critical Authentications	1180
Command to Throttle AAA Requests Using Recovery Delay	1181
VLAN Definitions Based on Enforcement States	1181
Local (Default) Access List (ACL) Definitions on the Switch	1182
Enable Switch Ports for 802.1X and MAB	1183
Command to Enable EPM Logging	1185
Command to Enable SNMP Traps	1185
Command to Enable SNMP v3 Query for Profiling	1185
Command to Enable MAC Notification Traps for Profiler to Collect	1186
RADIUS Idle-Timeout Configuration on the Switch	1186
Wireless Controller Configuration for iOS Supplicant Provisioning	1186
Configuring ACLs on the Wireless LAN Controller for Mobile Device Management Interoperability	1187

CHAPTER 36**Supported Management Information Bases for Cisco ISE Endpoint Profiler 1189**

IF-MIB	1189
SNMPv2-MIB	1190
IP-MIB	1190
CISCO-CDP-MIB	1190
CISCO-VTP-MIB	1191
CISCO-STACK-MIB	1192
BRIDGE-MIB	1192
OLD-CISCO-INTERFACE-MIB	1192
CISCO-LWAPP-AP-MIB	1192
CISCO-LWAPP-DOT11-CLIENT-MIB	1194
CISCO-AUTH-FRAMEWORK-MIB	1194
EEE8021-PAE-MIB: RFC IEEE 802.1X	1195
HOST-RESOURCES-MIB	1195
LLDP-MIB	1195

THE SPECIFICATIONS AND INFORMATION REGARDING THE PRODUCTS IN THIS MANUAL ARE SUBJECT TO CHANGE WITHOUT NOTICE. ALL STATEMENTS, INFORMATION, AND RECOMMENDATIONS IN THIS MANUAL ARE BELIEVED TO BE ACCURATE BUT ARE PRESENTED WITHOUT WARRANTY OF ANY KIND, EXPRESS OR IMPLIED. USERS MUST TAKE FULL RESPONSIBILITY FOR THEIR APPLICATION OF ANY PRODUCTS.

THE SOFTWARE LICENSE AND LIMITED WARRANTY FOR THE ACCOMPANYING PRODUCT ARE SET FORTH IN THE INFORMATION PACKET THAT SHIPPED WITH THE PRODUCT AND ARE INCORPORATED HEREIN BY THIS REFERENCE. IF YOU ARE UNABLE TO LOCATE THE SOFTWARE LICENSE OR LIMITED WARRANTY, CONTACT YOUR CISCO REPRESENTATIVE FOR A COPY.

The Cisco implementation of TCP header compression is an adaptation of a program developed by the University of California, Berkeley (UCB) as part of UCB's public domain version of the UNIX operating system. All rights reserved. Copyright © 1981, Regents of the University of California.

NOTWITHSTANDING ANY OTHER WARRANTY HEREIN, ALL DOCUMENT FILES AND SOFTWARE OF THESE SUPPLIERS ARE PROVIDED "AS IS" WITH ALL FAULTS. CISCO AND THE ABOVE-NAMED SUPPLIERS DISCLAIM ALL WARRANTIES, EXPRESSED OR IMPLIED, INCLUDING, WITHOUT LIMITATION, THOSE OF MERCHANTABILITY, FITNESS FOR A PARTICULAR PURPOSE AND NON-INFRINGEMENT OR ARISING FROM A COURSE OF DEALING, USAGE, OR TRADE PRACTICE.

IN NO EVENT SHALL CISCO OR ITS SUPPLIERS BE LIABLE FOR ANY INDIRECT, SPECIAL, CONSEQUENTIAL, OR INCIDENTAL DAMAGES, INCLUDING, WITHOUT LIMITATION, LOST PROFITS OR LOSS OR DAMAGE TO DATA ARISING OUT OF THE USE OR INABILITY TO USE THIS MANUAL, EVEN IF CISCO OR ITS SUPPLIERS HAVE BEEN ADVISED OF THE POSSIBILITY OF SUCH DAMAGES.

Any Internet Protocol (IP) addresses and phone numbers used in this document are not intended to be actual addresses and phone numbers. Any examples, command display output, network topology diagrams, and other figures included in the document are shown for illustrative purposes only. Any use of actual IP addresses or phone numbers in illustrative content is unintentional and coincidental.

All printed copies and duplicate soft copies of this document are considered uncontrolled. See the current online version for the latest version.

Cisco has more than 200 offices worldwide. Addresses and phone numbers are listed on the Cisco website at www.cisco.com/go/offices.

The documentation set for this product strives to use bias-free language. For purposes of this documentation set, bias-free is defined as language that does not imply discrimination based on age, disability, gender, racial identity, ethnic identity, sexual orientation, socioeconomic status, and intersectionality. Exceptions may be present in the documentation due to language that is hardcoded in the user interfaces of the product software, language used based on standards documentation, or language that is used by a referenced third-party product.

Cisco and the Cisco logo are trademarks or registered trademarks of Cisco and/or its affiliates in the U.S. and other countries. To view a list of Cisco trademarks, go to this URL: <https://www.cisco.com/c/en/us/about/legal/trademarks.html>. Third-party trademarks mentioned are the property of their respective owners. The use of the word partner does not imply a partnership relationship between Cisco and any other company. (1721R)

© 2017–2019 Cisco Systems, Inc. All rights reserved.



PART I

Introduction

- [Cisco ISE Features, on page 1](#)
- [Navigate the Admin portal, on page 11](#)
- [What Is Wireless Setup, on page 31](#)



CHAPTER 1

Cisco ISE Features

- [Cisco ISE Overview, on page 1](#)
- [Key Functions, on page 2](#)
- [Identity-Based Network Access, on page 2](#)
- [Support for Multiple Deployment Scenarios, on page 3](#)
- [Support for UCS Hardware, on page 3](#)
- [Basic User Authentication and Authorization, on page 3](#)
- [Policy Sets, on page 4](#)
- [Support for Common Access Card Functions, on page 5](#)
- [Client Posture Assessment, on page 5](#)
- [Mobile Device Manager Interoperability with Cisco ISE, on page 6](#)
- [Profiled Endpoints on the Network, on page 6](#)
- [pxGrid Persona, on page 6](#)
- [TACACS+ Device Administration, on page 6](#)
- [Support for SXP, on page 7](#)
- [Third Party Device Support, on page 7](#)
- [Telemetry, on page 7](#)
- [IPv6 Support, on page 8](#)
- [Location Based Authorization, on page 8](#)
- [Cisco ISE Certificate Authority, on page 9](#)
- [Support for Active Directory Multidomain Forests, on page 9](#)
- [Support for Automatic Failover for the Administration Node, on page 9](#)
- [GUI-Based Upgrade, on page 10](#)
- [Technical Support Tunnel for Advanced Troubleshooting, on page 10](#)

Cisco ISE Overview

Cisco ISE is a security policy management platform that provides secure access to network resources. Cisco ISE functions as a policy decision point and enables enterprises to ensure compliance, enhance infrastructure security, and streamline service operations. Cisco ISE allows enterprises to gather real-time contextual information from networks, users, and devices. The administrator can then use that information to make governance decisions by tying identity to various network elements, including access switches, wireless LAN controllers (WLCs), Virtual Private Network (VPN) gateways, and data center switches. Cisco ISE acts as the policy manager in the Cisco TrustSec solution and supports TrustSec software-defined segmentation.

The Cisco ISE software must be installed as is. You cannot install any other third-party applications at the underlying OS level.

ISE Community Resource

Join the ISE Community to view resources, ask questions, and participate in discussions. See [ISE Product Documentation](#), [YouTube Videos](#), and [Training Resources](#).

Note The examples and screenshots provided in the ISE Community resources may be from earlier releases of Cisco ISE. Check the GUI for newer or extra features and updates.

Key Functions

Cisco ISE is a consolidated policy-based access control system that incorporates a superset of features available in existing Cisco policy platforms. Cisco ISE performs the following functions:

- Combines authentication, authorization, accounting (AAA), posture, and profiler into one appliance
- Provides for comprehensive guest access management for Cisco ISE administrators, sanctioned sponsor administrators, or both
- Enforces endpoint compliance by providing comprehensive client provisioning measures and assessing the device posture for all endpoints that access the network, including 802.1X environments
- Provides support for discovery, profiling, policy-based placement, and monitoring of endpoint devices on the network
- Enables consistent policy in centralized and distributed deployments that allows services to be delivered where they are needed
- Employs advanced enforcement capabilities including Trustsec through the use of Security Group Tags (SGTs) and Security Group Access Control Lists (SGACLs)
- Supports scalability to support a number of deployment scenarios from small office to large enterprise environments
- Facilitates TACACS-enabled device administration through its Work Center. The Work Center menu contains all the device administration pages, which acts as a single start point for ISE administrators. However, pages such as Users, User Identity Groups, Network Devices, Default Network Devices, Network Device Groups, Authentication and Authorization Conditions, are shared with other menu options.

Identity-Based Network Access

The Cisco ISE solution provides context-aware identity management in the following areas:

- Cisco ISE determines whether users are accessing the network on an authorized, policy-compliant device.
- Cisco ISE establishes user identity, location, and access history, which can be used for compliance and reporting.

- Cisco ISE assigns services based on the assigned user role, group, and associated policy (job role, location, device type, and so on).
- Cisco ISE grants authenticated users with access to specific segments of the network, or specific applications and services, or both, based on authentication results.

Support for Multiple Deployment Scenarios

Cisco ISE can be deployed across an enterprise infrastructure, supporting 802.1X wired, wireless, and Virtual Private Networks (VPNs).

The Cisco ISE architecture supports both standalone and distributed (also known as *high availability* or *redundancy*) deployments, where one machine assumes the primary role, and another *backup* machine assumes the secondary role. Cisco ISE features distinct configurable personas, services, and roles, which allow you to create and apply Cisco ISE services where they are needed in the network. The result is a comprehensive Cisco ISE deployment that operates as a fully functional and integrated system.

Cisco ISE nodes can be deployed with one or more of the Administration, Monitoring, and Policy Service personas. Each persona performs a different vital part in your overall network policy management topology. Installing Cisco ISE with an administration persona allows you to configure and manage your network from a centralized portal to promote efficiency and ease of use.

Support for UCS Hardware

Cisco ISE 2.2 supports the following hardware platforms:

- SNS-3415 (small)
- SNS-3495 (large)
- SNS-3515 (small)
- SNS-3595 (large)

Refer to Table 3 in the [Cisco Identity Services Engine Data Sheet](#) for the hardware specifications.

Basic User Authentication and Authorization

User authentication policies in Cisco ISE enable you to provide authentication for a number of user login session types using a variety of standard authentication protocols including, but not limited to, Password Authentication Protocol (PAP), Challenge-Handshake Authentication Protocol (CHAP), Protected Extensible Authentication Protocol (PEAP), and Extensible Authentication Protocol (EAP). Cisco ISE specifies the allowable protocol(s) that are available to the network devices on which the user tries to authenticate and specifies the identity sources from which user authentication is validated.

Cisco ISE allows for a wide range of variables within authorization policies to ensure that only authorized users can access the appropriate resources when they access the network. The initial release of Cisco ISE supports only RADIUS-governed access to the internal network and its resources.

At the most fundamental level, Cisco ISE supports 802.1X, MAC authentication bypass (MAB), and browser-based Web authentication login for basic user authentication and access via both wired and wireless networks. Upon receiving an authentication request, the “outer part” of the authentication policy is used to select the set of protocols that are allowed when processing the request. Then, the “inner part” of the authentication policy is used to select the identity source that is used to authenticate the request. The identity source may consist of a specific identity store or an identity store sequence that lists a set of accessible identities until the user received a definitive authorization response.

Once authentication succeeds, the session flow proceeds to the authorization policy. (There are also options available that allow Cisco ISE to process the authorization policy even when the authentication did not succeed.) Cisco ISE enables you to configure behavior for “authentication failed,” “user not found,” and “process failed” cases, and also to decide whether to reject the request, drop the request (no response is issued), or continue to the authorization policy. In cases where Cisco ISE continues to perform authorization, you can use the “AuthenticationStaus” attribute in the “NetworkAccess” dictionary to incorporate the authentication result as part of the authorization policy.

The authorization policy result is Cisco ISE assigning an authorization profile that might also involve a downloadable ACL specifying traffic management on the network policy enforcement device. The downloadable ACL specifies the RADIUS attributes that are returned during authentication and that define the user access privileges granted once authenticated by Cisco ISE.



Note Cisco ISE processes the attributes in the following order while identifying the Authentication session for the incoming accounting packet:

- For Cisco devices:
 1. Class/State
 2. audit-session-id
 - For third party devices:
 1. Class/State
 2. Calling-Station-ID
 3. If the authentication session cannot be identified, Cisco ISE creates a new session ID based on the Calling-Station-ID, NAS-Port, and NAS-IP-Address.
-

Policy Sets

Cisco ISE supports policy sets, which let you group sets of authentication and authorization policies. As opposed to the basic authentication and authorization policy model, which is a flat list of authentication and authorization rules, policy sets let you logically define the organization’s IT business use cases into policy groups or services, such as VPN and 802.1x, such that it is easier for configuration, deployment, and troubleshooting.

You must enable Policy Sets on **Administration > System > Settings > Policy Settings** to make them available on the **Policy** menu.

[ISE Community Resource](#)

For information about getting RADIUS information from switches, see [WLC Called-Station-ID \(Radius Authentication and Accounting Config\)](#)

Support for Common Access Card Functions

Cisco ISE supports U.S. government users who authenticate themselves using Common Access Card (CAC) authentication devices. A CAC is an identification badge with an electronic chip containing a set of X.509 client certificates that identify a particular employee of, for example, the U.S. Department of Defense (DoD). Access via the CAC requires a card reader into which the user inserts the card and enters a PIN. The certificates from the card are then transferred into the Windows certificate store, where they are available to applications such as the local browser running Cisco ISE.

Benefits of using a CAC card to authenticate include these:

- Common Access Card X.509 certificates are the identity source for 802.1X EAP-TLS authentication.
- Common Access Card X.509 certificates are also the identity source for authentication and authorization to Cisco ISE administration.

Cisco ISE only supports login to the Admin portal. It does not support CAC authentication for the following access methods:

- You cannot use CAC authentication login to manage the Cisco ISE Command Line Interface.
- External REST API (Monitoring and Troubleshooting) and Endpoint Protection Services Adaptive Network Control APIs are outside the scope of the CAC authentication.
- Guest Services and Guest Sponsor Administration access does not support the CAC authentication method in Cisco ISE.

Client Posture Assessment

To ensure that the imposed network security measures remain relevant and effective, Cisco ISE enables you to validate and maintain security capabilities on any client machine that accesses the protected network. By employing posture policies that are designed to ensure that up-to-date security settings or applications are available on client machines, the Cisco ISE administrator can ensure that any client machine that accesses the network meets, and continues to meet, the defined security standards for enterprise network access. Posture compliance reports provide Cisco ISE with a snapshot of the compliance level of the client machine at the time of user login, as well as any time a periodic reassessment occurs.

Posture assessment and compliance occurs using one of the following agent types available in Cisco ISE:

- Cisco NAC Web Agent: A temporal agent that the users install on their system at the time of login and that is no longer visible on the client machine once the login session terminates.
- Cisco NAC Agent: A persistent agent that, once installed, remains on a Windows or Mac OS X client machine to perform all security compliance functions.
- AnyConnect ISE Agent: A persistent agent that can be installed on Windows or Mac OS X client to perform posture compliance functions.

Mobile Device Manager Interoperability with Cisco ISE

Mobile Device Management (MDM) servers secure, monitor, manage, and support mobile devices deployed across mobile operators, service providers, and enterprises. MDM enforces policy on endpoints, but it cannot force users to register their device or force remediation. ISE retrieves policies from the MDM server, and enforces those policies when users register their devices. If the ISE device policy requires MDM, and the device is not compliant with MDM, then ISE redirects the user to the MDM on-boarding portal, and prompts the user to update the device for network access. ISE can also allow internet-only access to users who decline MDM compliance.

Profiled Endpoints on the Network

The Profiler service assists in identifying, locating, and determining the capabilities of all endpoints on your network (known as identities in Cisco ISE), regardless of their device types, to ensure and maintain appropriate access to your enterprise network. The Cisco ISE Profiler function uses a number of probes to collect attributes for all endpoints on your network, and pass them to the Profiler analyzer, where the known endpoints are classified according to their associated policies and identity groups.

The Profiler Feed service allows administrators to retrieve new and updated endpoint profiling policies and the updated OUI database as a feed from a designated Cisco feed server through a subscription in to Cisco ISE.

pxGrid Persona

Cisco pxGrid is used to enable the sharing of contextual-based information from Cisco ISE session directory to other policy network systems such as Cisco Adaptive Security Appliance (ASA). The pxGrid framework can also be used to exchange policy and configuration data between nodes like sharing tags and policy objects between ISE and third party vendors, and for non-ISE related information exchanges such as threat information.

TACACS+ Device Administration

Cisco ISE supports device administration using the Terminal Access Controller Access-Control System (TACACS+) security protocol to control and audit the configuration of network devices. The network devices are configured to query ISE for authentication and authorization of device administrator actions, and send accounting messages for ISE to log the actions. It facilitates granular control of who can access which network device and change the associated network settings. An ISE administrator can create policy sets that allow TACACS results, such as command sets and shell profiles, to be selected in authorization policy rules in a device administration access service. The ISE Monitoring node provides enhanced reports related to device administration. The Work Center menu contains all the device administration pages, which acts as a single start point for ISE administrators.

ISE requires a Device Administration license to use TACACS+.

Support for SXP

Source Group Tag (SGT) Exchange Protocol (SXP) is used to propagate the SGTs across network devices that do not have hardware support for TrustSec. SXP is used to transport an endpoint's SGT along with the IP address from one SGT-aware network device to another.

To enable SXP service on a node, check the Enable SXP Service check box in the General Node Settings page. You must also specify the interface to be used for SXP service.

Each SXP connection has one peer designated as SXP speaker and the other peer as SXP listener. The peers can also be configured in a bi-directional mode where each of them act as both speaker and listener. Connections can be initiated by either peers, but mapping information is always propagated from a speaker to a listener.

Third Party Device Support

Cisco ISE supports some third-party network access devices (NADs) through the use of network device profiles. These profiles define the capabilities that Cisco ISE uses to enable flows such as Guest, BYOD, MAB, and Posture.

Cisco ISE includes predefined profiles for network devices from the following vendors:

- Cisco—Wired and Wireless
- Aruba—Wireless
- HP—Wired and Wireless
- Motorola—Wireless
- Brocade—Wired
- Alcatel—Wired
- Ruckus—Wireless

You can also create profiles for additional third-party network device that does not have a predefined profile. AnyConnect client provisioning and posture discovery do not mandate CoA and URL redirection.

If you have deployed non-Cisco NADs prior to Release 2.0 and created policy rules/RADIUS dictionaries to use them, after upgrade these will continue to work as usual.

Telemetry

After installation, when you log in to the Admin portal for the first time, the Cisco ISE Telemetry banner appears on screen. Using this feature, Cisco ISE securely collects non-sensitive information about your deployment, network access devices, profiler, and other services that you are using. The data that is collected will be used to provide better services and additional features in forthcoming releases. By default, the telemetry feature is enabled. You can choose to disable it from the Admin portal.

IPv6 Support

From Cisco ISE, Release 2.0 onwards, the following IPv6 capabilities are supported:

- Support for IPv6-Enabled Endpoints: Cisco ISE can detect, manage, and secure IPv6 traffic from endpoints. You can configure authorization profiles and policies in Cisco ISE using IPv6 attributes to process requests from IPv6-enabled endpoints and ensure that the endpoint is compliant.
- IPv6 Support in Reports: Reports in Release 2.0 support IPv6 values. The Live Session and Live Authentication pages also support IPv6 values.
 - ipv6 address-To allow for static IPv6 address configuration per network interface
 - ipv6 enable-To enable or disable IPv6 on all network interfaces
 - ipv6 route-To configure IPv6 static routes
 - ip host-To allow for adding IPv6 addresses in host local table
 - show IPv6 route-To display IPv6 routes



Note If you choose to configure IPv6 address, you should also have an IPv4 address configured (in addition to IPv6 address) for the Cisco ISE node communication. Hence, dual stack (combination of both IPv4 and IPv6) is required.

Refer to the [Cisco Identity Services Engine CLI Reference Guide](#) for your release of ISE for more information about these commands.

Location Based Authorization

Cisco ISE integrates with Cisco Mobility Services Engine (MSE) to introduce physical location-based authorization. Cisco ISE uses information from MSE to provide differentiated network access based on the actual location of the user, as reported by MSE.

With this feature, you can use the endpoint location information to provide network access when a user is in an appropriate zone. You can also add the endpoint location as an additional attribute for policies to define more granulated policy authorization sets based on device location. You can configure conditions within authorization rules that use location-based attributes, for example:

MSE.Location Equals LND_Campus1:Building1:Floor2:SecureZone

You can define the location hierarchy (campus/building/floor structure) and configure the secure and non-secure zones using the Cisco Prime Infrastructure application. After defining the location hierarchy, you must synchronize the location hierarchy data with the MSE servers.

The Location Tree is created by using the location data retrieved from the MSE instances. You can select the location entries that are exposed to the authorization policy by using the Location Tree.

Cisco ISE Certificate Authority

Cisco ISE provides a native Certificate Authority (CA) that issues and manages digital certificates for endpoints from a centralized console to allow employees to connect to the company's network using their personal devices. Cisco ISE CA supports standalone and subordinate deployments.

Certificate Provisioning Portal

Cisco ISE offers a Certificate Provisioning portal that allows employees to request certificates for devices that cannot go through the onboarding flow. For example, devices such as point-of-sale terminals cannot go through the BYOD flow and need to be issued certificates manually. The Certificate Provisioning portal allows a privileged set of users to upload a certificate request for such devices, generate key pairs (if required), and download the certificate. Employees can access this portal and request for a single certificate or make a bulk certificate request using a CSV file.

Certificate Template Extension

The Cisco ISE Internal CA includes an extension to represent the certificate template that was used to create the endpoint certificate. All endpoint certificates issued by the internal CA contain a certificate template name extension. This extension represents the certificate template that was used to create that endpoint certificate. You can use the CERTIFICATE: Template Name attribute in authorization policy conditions and assign appropriate access privileges based on the results of the evaluation.

Cisco ISE Internal CA Issues Certificates to ASA VPN Users

The internal ISE CA can issue certificates to client machines that connect over ASA VPN. ISE uses the Simple Certificate Enrollment Protocol (SCEP) for enrollment and to provision certificates from Cisco ISE to the client machines.

Support for Active Directory Multidomain Forests

Cisco ISE supports Active Directory with multidomain forests. Cisco ISE connects to a single domain, but can access resources from the other domains in the Active Directory forest if trust relationships are established between the domain to which Cisco ISE is connected and the other domains.

Support for Automatic Failover for the Administration Node

Cisco ISE supports Automatic Failover for the Administration persona. To enable the automatic failover feature, at least two nodes in your distributed setup should assume the Administration persona and one node should assume the nonadministration persona. If the primary PAN goes down, an automatic promotion of the secondary PAN is initiated. For this, a non-administration secondary node is designated as the health check node for each of the PANs. The health check node checks the health of the primary PAN at configured intervals. If the health check response received for the primary PAN is not good for reasons, such as the device being down or unreachable, the health check node initiates the promotion of the secondary PAN to take over the primary role after waiting for the configured threshold value. Some features are unavailable after automatic

failover of the secondary PAN. Cisco ISE does not support fallback to the original primary PAN. See the [High Availability for the Administrative Node](#) section for more information.

GUI-Based Upgrade

Cisco ISE offers a GUI-based centralized upgrade from the Admin portal. The upgrade process is much simplified and the progress of the upgrade and the status of the nodes are displayed on screen.



Note The GUI-based upgrade is applicable only if you are upgrading from Release 2.0 to a higher release or if you are upgrading a Limited Availability Release of Cisco ISE 2.0 to the General Availability Release.

Technical Support Tunnel for Advanced Troubleshooting

Cisco ISE uses the Cisco IronPort Tunnel infrastructure to create a secure tunnel for Cisco technical support engineers to connect to an ISE server in your deployment and troubleshoot issues with the system. Cisco ISE uses SSH to create the secure connection through the tunnel. As an administrator, you can control the tunnel access; you can choose when and how long to grant access to the support engineer. Cisco Customer Support cannot establish the tunnel without your intervention. You will receive notification about the service logins. You can disable the tunnel connection at any point of time.



CHAPTER 2

Navigate the Admin portal

- [Administration Portal, on page 11](#)
- [Cisco ISE Internationalization and Localization, on page 22](#)
- [MAC Address Normalization, on page 29](#)

Administration Portal

The administration portal provides access to Cisco ISE configuration and reporting. The following figure shows the main elements of the menu bar of the administration portal.

Figure 1: Cisco ISE Administration Portal

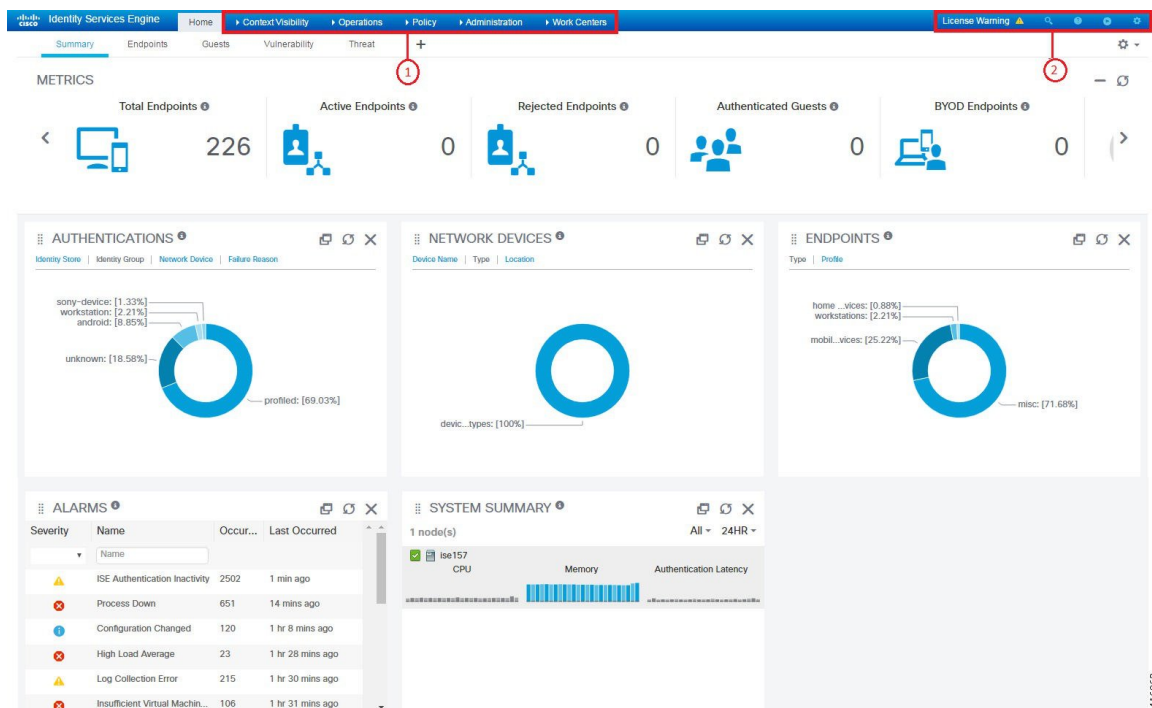





Table 1: Components of the Cisco ISE Administration Portal

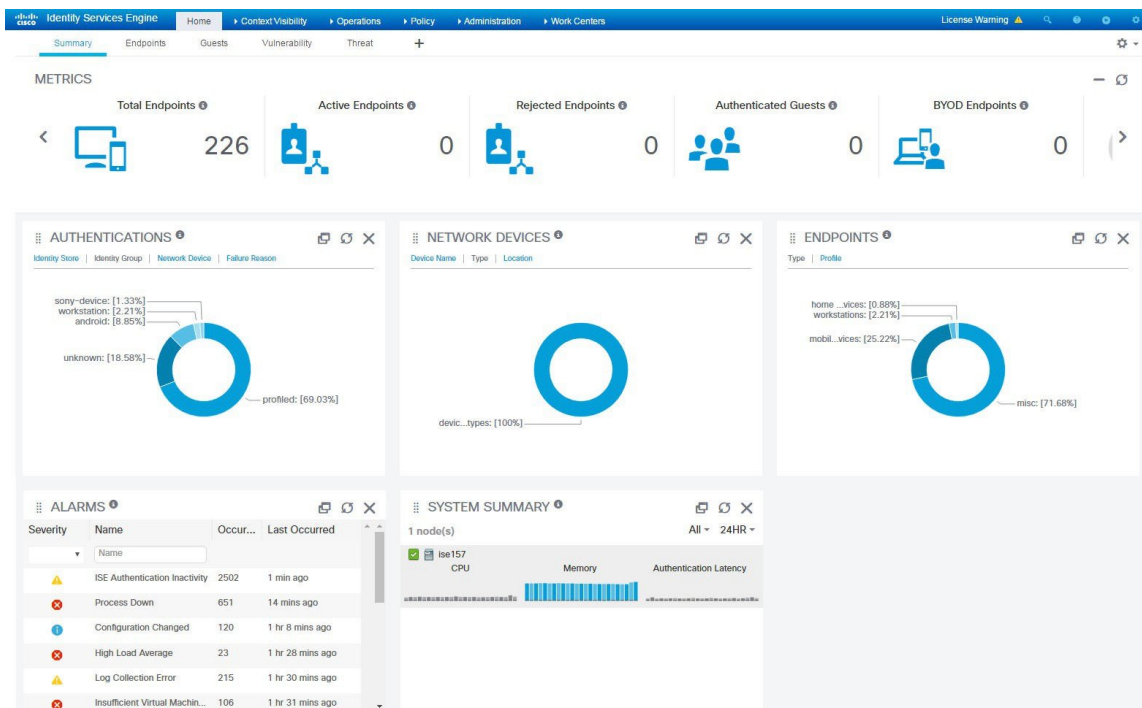
1	Menu Drop-downs	<ul style="list-style-type: none">• Context Visibility: The context visibility windows display information about endpoints, users, and network access devices (NAD). The context visibility information is segmented by features, applications, Bring Your Own Device (BYOD), and other categories, depending on the licenses you have registered. The context visibility windows use a central database and gather information from database tables, caches, and buffers. As a result, the content in the context visibility dashlets and lists updates quickly. The context visibility windows consist of dashlets at the top, and a list of information at the bottom. When you filter data by modifying the column attributes in the list, the dashlets refresh to display the modified content.• Policy: Policy windows include tools for managing network security in the areas of authentication, authorization, profiling, posture, and client provisioning.• Administration: Administration windows include tools for managing Cisco ISE nodes, licenses, certificates, network devices, users, endpoints, and guest services.
---	-----------------	--

2	Top-Right Menu Icons	<ul style="list-style-type: none"> •  <p>Use this icon to search for endpoints and display their distribution by profiles, failures, identity stores, location, device type, and so on.</p> •  <p>Click this icon for a drop-down list that allows you to access the online help for the currently displayed page, and links to the Cisco ISE Community, Portal Builder, and more.</p> • Click this icon to access the following options: <ul style="list-style-type: none"> • PassiveID Setup: The PassiveID Setup option launches the PassiveID Setup wizard to set up passive identity using Active Directory. Configure the server to gather user identities and IP addresses from external authentication servers and deliver the authenticated IP addresses to the corresponding subscriber. • Visibility Setup: The Visibility Setup option launches the ISE Visibility Setup wizard that allows you to add a list of IP address ranges for endpoint discovery. • Wireless Setup (BETA): The Wireless Setup (BETA) option provides an easy way to set up wireless flows for 802.1X, Guest services, and BYOD. This option also provides workflows to configure and customize each portal for Guest services and BYOD. •  <p>Click this icon for a menu of system activities, including launching online help, and configuring account settings.</p>
---	----------------------	--

Cisco ISE Home Dashboards

The Cisco ISE Home dashboard displays live consolidated and correlated statistical data that is essential for effective monitoring and troubleshooting. Dashboard elements typically display activity over 24 hours. The following figure is an example of the information available in a Cisco ISE dashboard. You can view the Cisco ISE dashboard data only in the primary Policy Administration node (PAN) portal.

Figure 2: Cisco ISE Home Dashboard



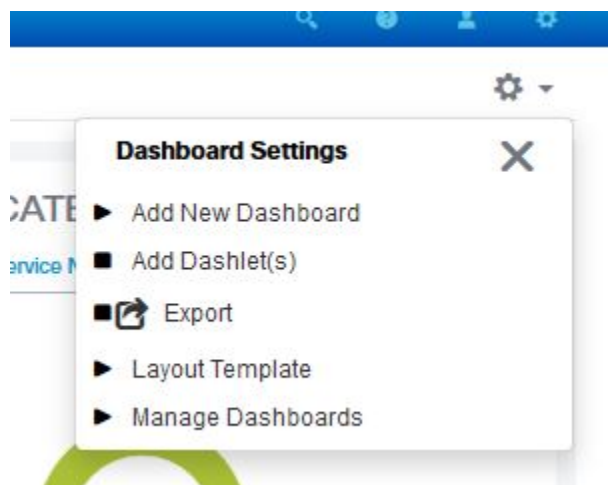
The home page has five default dashboards that display your Cisco ISE data. Each of these dashboards has several predefined dashlets.

- **Summary:** This dashboard contains a linear metrics dashlet, pie chart dashlets, and list dashlets. The metrics dashlet is not configurable. By default this dashboard contains the dashlets **Status Endpoints**, **Endpoint Categories**, and **Network Devices**.
- **Endpoints:** By default, this dashboard contains the dashlets **Status**, **Endpoints**, **Endpoint Categories**, and **Network Devices**.
- **Guests:** This dashboard contains dashlets that provide information on guest user type, log in failures, and location of activity.
- **Vulnerability:** This dashboard displays the information that vulnerability servers report to Cisco ISE.
- **Threat:** This dashboard displays information from the threat servers reports sent to Cisco ISE.

Configuring Home Dashboards

You can customize a home page dashboard by clicking the **Gear** icon in the top right corner of the window:

Figure 3: Customize A Dashboard



The following options are displayed in the drop-down list:

- **Add New Dashboard** allows you to add a new dashboard. Enter a value in the field that is displayed and click **Apply**.
- **Add Dashlet(s)** displays a dialog box with a list of dashlets available. Click **Add** or **Remove** next to the dashlet name to add or remove a dashlet from the dashboard.
- **Export** saves the selected home page view to a PDF.
- **Layout Template** configures the number of columns that are displayed in this view.
- **Manage Dashboards** contains two options:
 - **Mark As Default Dashboard:** Choose this option to make the current dashboard the default view when you choose Home.
 - **Reset All Dashboards:** Use this option to also reset all the dashboards and remove your configurations on all the Home dashboards.

Context Visibility Views

The structure of a **Context Visibility** window is similar to the home page, except that the Context Visibility windows:

- Retain your current context (browser window) when you filter the displayed data
- Are more customizable
- Focus on endpoint data

You can view the context visibility data only from the primary PAN.

Dashlets on the **Context Visibility** windows show information about endpoints, and endpoint connections to NADs. The information currently displayed is based on the content in the list of data below the dashlets on each window. Each window displays endpoint data, based on the name of the tab. As you filter the data, both the list and dashlets update. You can filter the data by clicking on parts of one or more of the circular graphs,

by filtering rows on the table, or any combination those actions. As you select filters, the effects are additive, also referred to as cascading filter, which allows you to drill down to find the particular data you are looking for. You can also click an endpoint in the list, and get a detailed view of that endpoint.

There are three main views under **Context Visibility**:

- **Endpoints**: Filter the endpoints you want to view based on types of devices, compliance status, authentication type, and more.



Note We recommend that you enable the accounting settings on the network access devices (NADs) to ensure that the accounting start and update information is sent to Cisco ISE.

Cisco ISE can collect accounting information, such as the latest IP address, status of the session (Connected, Disconnected, or Rejected), the number of days an endpoint has been inactive, only if accounting is enabled. This information is displayed in the **Live Logs**, **Live Sessions** and **Context Visibility** windows in the Cisco ISE administration portal. When accounting is disabled on a NAD, there might be a missing, incorrect, or mismatched accounting information between the **Live Sessions**, **Live Logs** and **Context Visibility** windows.



Note The **Visibility Setup** workflow that is available on the Cisco ISE administration portal home page allows you to add a list of IP address ranges for endpoints discovery. After this workflow is configured, Cisco ISE authenticates the endpoints, but the endpoints that are not included in the configured IP address ranges are not displayed in the **Context Visibility > Endpoints** window and the **Endpoints** listing page (**Work Centers > Network Access > Identities > Endpoints**).

- **Users**: Displays user-based information from user identity sources.

If there is a change in the username or password attribute, it reflects in the **Users** window when there is a change in the authentication status.

If the username is changed in the Microsoft Active Directory, the updated change is displayed in the **Users** window immediately after re-authentication.

If any other attributes such as Email, Phone, Department, etc are changed in the Microsoft Active Directory, the updated attributes are displayed in the **Users** window 24 hours after re-authentication.



Note Updating User Attributes from AD depends on the interval configured under Active Directory Probe. For more information, see [Active Directory Probe](#).

- **Network Devices**: This window displays the list of NADs that have endpoints connected to them. For any NAD, click the number of endpoints that is displayed in the corresponding **# of endpoints** column. A window that lists all the devices filtered by that NAD is displayed.



Note If you have configured your network device with SNMPv3 parameters, you cannot generate the **Network Device Session Status Summary** report that is provided by the Cisco ISE monitoring service (**Operations > Reports > Catalog > Network Device > Session Status Summary**). You can generate this report successfully if your network device is configured with SNMPv1 or SNMPv2c parameters.

You can create a new tab in the **Context Visibility** windows and create a custom list for additional filtering. Dashlets are not supported in custom views.

Click a section of a circular graph in a dashlet to view a new window with filtered data from that dashlet in. From this new window, you can continue to filter the displayed data, as described in [Filtering Displayed Data in a View, on page 18](#).

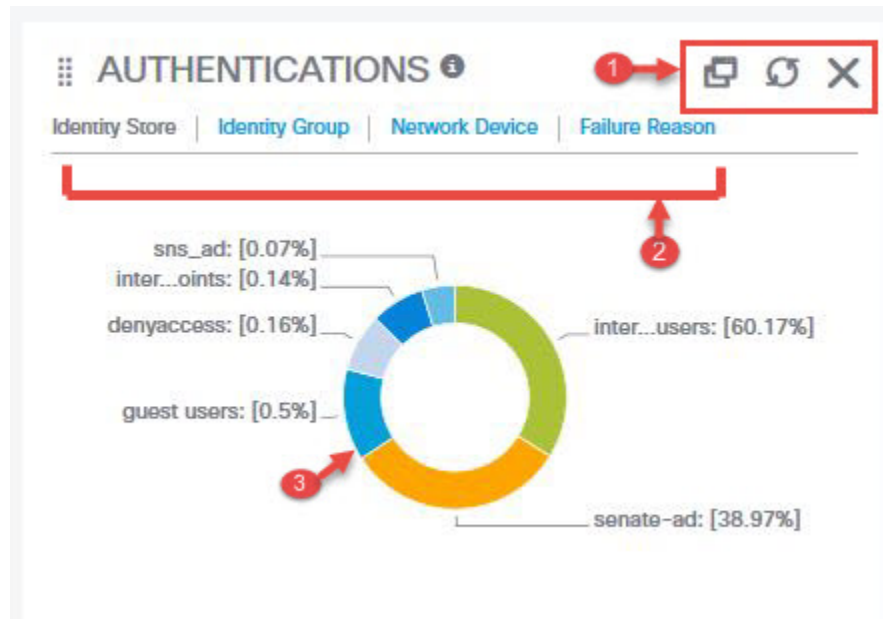
For more information about using Context Visibility windows to find endpoint data, see the following Cisco YouTube video which uses ISE 2.1 <https://www.youtube.com/watch?v=HvonGhrydfg>.

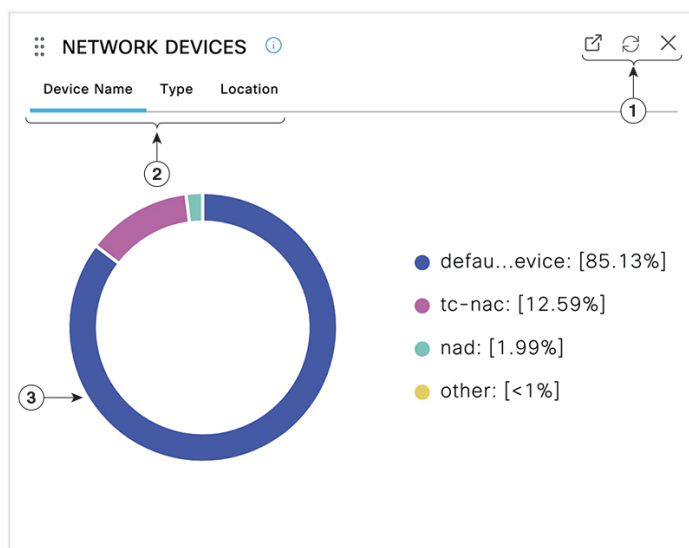
Related Topics

[The Hardware Dashboard](#)

Dashlets

The following image is an example of a dashlet:





1. The stacked window symbol “detaches”, Open New Window icon opens this dashlet in a new browser window. The pie chart refreshes. Click the **X** to delete this dashlet. This option is only available on the home page. You delete dashlets in Context Visibility windows using the gear symbol in the top-right corner of the screen.
2. Some dashlets have different categories of data. Click the category to see a pie chart with that set of data.
3. The pie chart shows the data that you have selected. Click one of the pie segments to open a new tab in with the filtered data, based on that pie segment.

Click a section of the pie chart in a home page dashboard to open the chart in a new browser window. The new window displays data that is filtered by the section of the pie chart that you clicked on.

When you click a section of the pie chart in a Context Visibility window, the displayed data is filtered but context does not change. You view the filtered data in the same browser window.

Filtering Displayed Data in a View

When you click a dashlet in a Context Visibility window, the corresponding data is filtered by the item you click and displayed. For example, when you click a section of a pie chart, the data for the chosen section is filtered and displayed.

ENDPOINTS ⓘ

Type | Profile



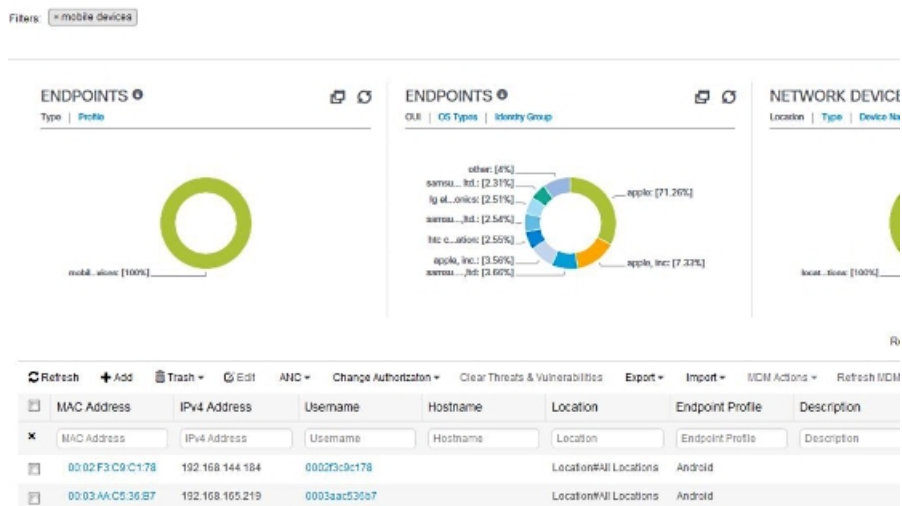
NETWORK DEVICES ⓘ

Device Name	Type	Location
-------------	------	----------

Device Type	Percentage
default device	85.13%
tc-nac	12.59%
nad	1.99%
other	<1%

If you click **mobile devices** in the **Endpoints** dashlet, the window refreshes to display two **Endpoints** dashlets, a **Network Devices** dashlet, and a list of data. The dashlets and list show data for mobile devices, as shown in the following example. A new window displays the data, as shown in the following image:

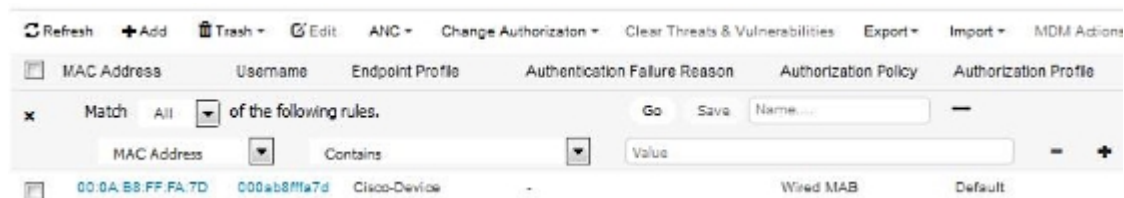
Filtering Displayed Data in a View



You can continue to filter data by clicking more sections of the pie charts, or by using the controls on the list of data.



1. The gear icon filters the displayed columns. From the drop-down list, choose the columns that you want to view in this dashboard's list.
2. The Quick Filter is displayed by default. Enter characters into the box (label number 3) to filter the list based on the result. The Custom Filter provides a more granular filter, as shown in the following image:



Save your custom filters.

Endpoint Actions in Dashlet Views

The toolbar at the top of the list allows you to act on endpoints in the list that you select. Not all actions are enabled for every list. Some actions depend on the feature that is enabled for use. The following list shows two endpoint actions that must be enabled in Cisco ISE before you can use them.

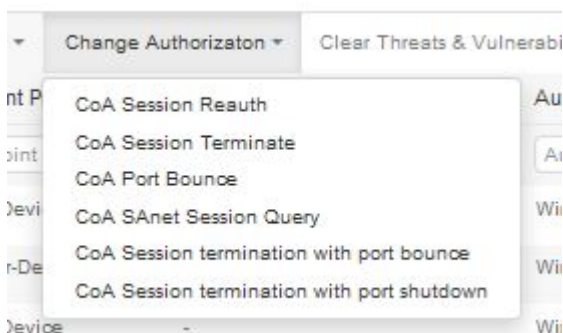
• Adaptive Network Control Actions

If you enable the Adaptive Network Control service, you can select endpoints in the list and assign or revoke network access. You can also issue a change of authorization.

Enable the Adaptive Network Services or Endpoint Protection Services in Cisco ISE in the **Adaptive Network Service** window. In the Cisco ISE GUI, click the **Menu** icon (☰) and choose **Administration > System > Settings > Endpoint Protection Service > Adaptive Network Control**. For more information, see [Enable Adaptive Network Control in Cisco ISE, on page 299](#).

When you click the pie chart on a home page dashlet, the new window that is displayed contains the options **ANC** and **Change Authorization**. Check the check box for the endpoint you want to perform an action on, and choose the necessary action from the drop-down lists of **ANC** and **Change Authorization**.

Figure 4: Endpoint Actions in Dashlet Views



• MDM Actions

If you connect an MDM server to Cisco ISE, you can perform MDM actions on selected endpoints. Choose the necessary action from the **MDM Actions** drop-down list.

Attributes in Context Visibility

The systems and services that provide attributes for Context Visibility sometimes have different values for the same attribute name. The following are a few examples:

For Operating System

- *OperatingSystem*: Posture operating system.
- *operating-system*: NMAP operating system.
- *operating-system-result*: Profiler consolidated operating system.



Note There might be some discrepancies in the endpoint operating system data that is displayed in the Context Visibility window when you enable multiple probes in Cisco ISE for an endpoint.

For Portal Name

- *PortalName*: Guest portal name when device registration is turned on.
- *PortalName*: Guest portal name when device registration is not turned on.

For Portal User

- *User-Name*: Username from RADIUS authentication.
- *GuestUserName*: Guest username.
- *PortalUser*: Portal username.

Cisco ISE Internationalization and Localization

Cisco ISE internationalization adapts the user interface to the supported languages. Localization of the user interface incorporates location-specific components and translated text. In Windows, MAC OSX, and Android devices, the native supplicant provisioning wizard can be used in any of the following supported languages.

In Cisco ISE, internationalization and localization support focuses on support for non-English text in UTF-8 encoding to the end user-facing portals and on selective fields in the administration portal.

Supported Languages

Cisco ISE provides localization and internationalization support for the following languages and browser locales.

Table 2: Supported Languages and Locales

Language	Browser Locale
Chinese traditional	zh-tw
Chinese simplified	zh-cn
Czech	cs-cz
Dutch	nl-nl
English	en
French	fr-fr
German	de-de
Hungarian	hu-hu
Italian	it-it

Language	Browser Locale
Japanese	ja-jp
Korean	ko-kr
Polish	pl-pl
Portuguese (Brazil)	pt-br
Russian	ru-ru
Spanish	es-es

End-User Web Portal Localization

The Guest, Sponsor, My Devices, and Client Provisioning portals are localized into all the supported languages and locales. This includes text, labels, messages, field names, and button labels. If a client browser requests a locale that is not mapped to a template in Cisco ISE, the portal displays content using the English template.

Using the administration portal, you can modify the fields that are used in the Guest, Sponsor, and My Devices portals for each language. You can also add other languages. Currently, you cannot customize these fields for the Client Provisioning portal.

You can further customize the Guest portal by uploading HTML pages to Cisco ISE. When you upload customized pages, you are responsible for the appropriate localization support for your deployment. Cisco ISE provides a localization support example with sample HTML pages, which you can use as a guide. Cisco ISE allows you to upload, store, and render custom internationalized HTML pages.



Note NAC and MAC agent installers, and WebAgent pages are not localized.

Support for UTF-8 Character Data Entry

Cisco ISE fields that are exposed to the end user (through the Cisco client agent or supplicants, or the Sponsor, Guest, My Devices, and Client Provisioning portals) support UTF-8 character sets for all languages. UTF-8 is a multibyte character encoding for the Unicode character set, which includes many different language character sets including Hebrew, Sanskrit, and Arabic.

Character values are stored in UTF-8 in the administration configuration database, and the UTF-8 characters display correctly in reports and user interface components.

UTF-8 Credential Authentication

Network access authentication supports UTF-8 username and password credentials. This includes RADIUS, Extensible Authentication Protocol (EAP), RADIUS proxy, RADIUS token, and web authentication from the Guest and administration portal login authentications. UTF-8 support for username and password applies to authentication against the local identity store and external identity stores.

UTF-8 authentication depends on the client supplicant that is used for network login. Some Windows native supplicants do not support UTF-8 credentials.



Note UTF-8 authentication with RSA is not supported as RSA does not support UTF-8 users. RSA servers, which are compatible with Cisco ISE, also do not support UTF-8.

UTF-8 Policies and Posture Assessment

Policy rules in Cisco ISE that are conditioned on attribute values may include UTF-8 text. Rule evaluation supports UTF-8 attribute values. You can also configure conditions with UTF-8 values through the administration portal.

Posture requirements are modified as File, Application, and Service conditions based on a UTF-8 character set. This includes sending UTF-8 requirement values to the NAC agent. The NAC agent then assesses the endpoint accordingly, and reports UTF-8 values when applicable.

Cisco NAC and MAC Agent UTF-8 Support

The Cisco NAC agent supports the internationalization of text, messages, and any UTF-8 data that is exchanged with Cisco ISE. This includes requirement messages, requirement names, and file and process names that are used in conditions.

The following limitations apply:

- UTF-8 support applies to Windows-based NAC agents only.
- Cisco NAC and MAC agent interfaces currently do not support localization.
- WebAgent does not support UTF-8-based rules and requirements.
- If an acceptable use policy (AUP) is configured, the policy pages are provided on the client side, based on the browser locale and the set of languages that are specified in the configuration. You are responsible for providing a localized AUP bundle or site URL.

UTF-8 Support for Messages Sent to Supplicant

RSA prompts and messages are forwarded to the supplicant using a RADIUS attribute REPLY-MESSAGE, or within EAP data. If the text contains UTF-8 data, it is displayed by the supplicant, based on the client's local operating system language support. Some Windows-native supplicants do not support UTF-8 credentials.

Cisco ISE prompts and messages may not be in synchrony with the locale of the client operating system on which the supplicant is running. You must align the end-user supplicant locale with the languages that are supported by Cisco ISE.

Reports and Alerts UTF-8 Support

Monitoring and troubleshooting reports and alerts support UTF-8 values for relevant attributes for the languages that are supported in Cisco ISE. The following activities are supported:

- Viewing live authentications.
- Viewing detailed pages of report records.
- Exporting and saving reports.
- Viewing the Cisco ISE dashboard.

- Viewing alert information.
- Viewing tcpdump data.

UTF-8 Character Support in the Portals

More character sets are supported in Cisco ISE fields (UTF-8) than are currently supported for localizations in portals and end-user messages. For example, Cisco ISE does not support right-to-left languages, such as Hebrew or Arabic, although the character sets themselves are supported.

The following table lists the fields in the Admin and end-user portals that support UTF-8 characters for data entry and viewing, with the following limitations:

- Cisco ISE does not support guest usernames and passwords with UTF-8 characters.
- Cisco ISE does not support UTF-8 characters in certificates.

Table 3: Administration Portal UTF-8 Character Fields

Administration Portal Element	UTF-8 Fields
Network access user configuration	<ul style="list-style-type: none"> • Username • First Name • Last Name • Email
User list	<ul style="list-style-type: none"> • All filter fields. • Values displayed in the User List window. • Values displayed in the left navigation quick view.

Administration Portal Element	UTF-8 Fields
User password policy	<p>The passwords can contain any combination of upper and lowercase letters, numbers, and special characters (including !, @, #, \$, ^, &, *, (, and). The password field accepts any characters including UTF-8 characters, but it does not accept control characters.</p> <p>Some languages do not have uppercase or lowercase alphabets. If your user password policy requires the user to enter a password with uppercase or lowercase characters and the user's language does not support these characters, the user cannot set a password. For the user password field to support UTF-8 characters, uncheck the following check boxes in the user password policy page (Administration > Identity Management > Settings > User Authentication Settings > Password Policy):</p> <ul style="list-style-type: none"> • Lowercase alphabetic characters • Uppercase alphabetic characters <p>You cannot use dictionary words, their characters in reverse order, or their letters replaced with other characters.</p>
Administrator list	<ul style="list-style-type: none"> • All filter fields. • Values that are displayed in the administrator list window. • Values that are displayed in the left navigation quick view.
Admin login page	<ul style="list-style-type: none"> • Username
RSA	<ul style="list-style-type: none"> • Messages • Prompts
RADIUS token	<ul style="list-style-type: none"> • Authentication tab > Prompt
Posture Requirement	<ul style="list-style-type: none"> • Name • Remediation action > Message shown to Agent User • Requirement list display

Administration Portal Element	UTF-8 Fields
Posture conditions	<p>The following fields in the Policy > Policy Elements > Conditions > Posture windows:</p> <ul style="list-style-type: none"> • File Condition > Add > File Path. • Application Condition > Add > Process Name. • Service Condition > Add > Service Name. • Conditions list displays.
Guest and My Devices settings	<ul style="list-style-type: none"> • Sponsor > Language Template: all supported languages, all fields. • Guest > Language Template: all supported languages, all fields. • My Devices > Language Template: all supported languages, all fields.
System settings	<ul style="list-style-type: none"> • SMTP Server > Default email address
Operations > Alarms > Rule	<ul style="list-style-type: none"> • Criteria > User • Notification > email notification user list
Operations > Reports	<ul style="list-style-type: none"> • Operations > Live Authentications > Filter fields • Operations > Reports > Catalog > Report filter fields
Operations > Troubleshoot	<ul style="list-style-type: none"> • General Tools > RADIUS Authentication Troubleshooting > Username
Policies	<ul style="list-style-type: none"> • Authentication > value for the antivirus expression within policy conditions • Authorization or posture or client provisioning > other conditions > value for the antivirus expression within policy conditions

Administration Portal Element	UTF-8 Fields
Attribute value in policy library conditions	<ul style="list-style-type: none"> • Authentication > simple condition or compound condition > value for the antivirus expression • Authentication > simple condition list display • Authentication > simple condition list > left navigation quick view display • Authorization > simple condition or compound condition > value for the antivirus expression • Authorization > simple condition list > left navigation quick view display • Posture > Dictionary simple condition or dictionary compound condition > value for the antivirus expression • Guest > simple condition or compound condition > value for the antivirus expression

UTF-8 Support Outside the Cisco ISE User Interface

This section contains the areas outside the Cisco ISE user interface that provide UTF-8 support.

Debug Log and CLI-Related UTF-8 Support

Attribute values and posture condition details appear in some debug logs. All debug logs accept UTF-8 values. You can download debug logs containing raw UTF-8 data that can be viewed with a UTF-8-supported viewer.

Cisco Secure ACS Migration UTF-8 Support

Cisco ISE allows the migration of Cisco Secure Access Control Server (ACS) UTF-8 configuration objects and values. Migration of some UTF-8 objects may not be supported by Cisco ISE UTF-8 languages, which might render some of the UTF-8 data that is provided during migration unreadable using the administration portal or report methods. Convert the unreadable UTF-8 values (that are migrated from Cisco Secure ACS) into ASCII text. For more information about migrating from Cisco Secure ACS to Cisco ISE, see the [Cisco Secure ACS to Cisco ISE Migration Tool](#) for your version of Cisco ISE.

Support for Importing and Exporting UTF-8 Values

The administration and Sponsor portals support plaintext and CSV files with the UTF-8 values to use when importing user account details. Exported files are provided as CSV files.

UTF-8 Support on REST

External Representational State Transfer (REST) communication supports UTF-8 values. This applies to configurable items that have UTF-8 support in the Cisco ISE user interface, except for administrator authentication. Administrator authentication in REST requires ASCII text credentials for login.

UTF-8 Support for Identity Stores Authorization Data

Cisco ISE allows Microsoft Active Directory and Lightweight Directory Access Protocol (LDAP) to use UTF-8 data in authorization policies for policy processing.

MAC Address Normalization

Cisco ISE supports normalization of the MAC address that you enter in any of the following formats:

- 00-11-22-33-44-55
- 0011.2233.4455
- 00:11:22:33:44:55
- 001122334455
- 001122-334455

Provide full or partial MAC addresses in the following Cisco ISE windows:

- Policy > Authorization
- **Policy > Policy Elements > Conditions > Authorization**
- Authentications > Filters (Endpoint and Identity columns)
- Global search
- **Operations > Reports > Report Filters**
- **Operations > Troubleshoot > Diagnostic Tools > General Tools > Endpoint Debug**

Provide full MAC addresses (six octets separated by ':', '-', or '.') in the following Cisco ISE windows:

- Operations > Endpoint Protection Services Adaptive Network Control
- **Operations > Troubleshoot > Diagnostic Tools > General Tools > RADIUS Authentication Troubleshooting**
- **Operations > Troubleshooting > Diagnostic Tools > General Tools > Posture Troubleshooting**
- Administration > Identities > Endpoints
- **Administration > System > Deployment**
- **Administration > Logging > Collection Filters**

REST APIs also support normalization of full MAC address.

The valid ranges for an octet are 0 to 9, a to f, or A to F.



CHAPTER 3


What Is Wireless Setup

Wireless Setup provides an easy way to set up wireless flows for 802.1X, Guest and BYOD services. It also provides workflows to configure and customize each portal for Guest and BYOD services, where appropriate. These workflows are much simpler than configuring the associated portal flow in Cisco ISE by providing the most common recommended settings. Wireless Setup does many steps for you that you would have to do yourself in Cisco ISE, and on the Wireless Controller, so you can quickly create a working environment.

You can use the Wireless Setup created environment to test and develop your flows. Once you get your Wireless Setup environment working, you may want to switch to Cisco ISE, so you can support advanced configurations. For more information about configuring Guest services in Cisco ISE, see the [ISE Administrators Guide](#) for your version of Cisco ISE, and the Cisco Community Site <https://community.cisco.com/t5/security-documents/ise-guest-amp-web-authentication/ta-p/3657224>. For more information about configuring and using Wireless Setup for Cisco ISE, see <https://community.cisco.com/t5/security-documents/cisco-ise-secure-access-wizard-saw-guest-byod-and-secure-access/ta-p/3636602>.



Note Cisco ISE Wireless Setup is beta software - please do not use Wireless Setup in production networks.

- Wireless Setup is disabled by default after fresh installation of Cisco ISE. You can enable Wireless Setup from the Cisco ISE CLI with the **application configure ise** command (select option 17) or by using the **Wireless Setup** option () available in the top right-hand corner in the Cisco ISE GUI home page.
- Run only one instance of Wireless Setup at a time. Only one person can run Wireless Setup at a time.
- If you upgrade Cisco ISE from a previous version, the Wireless Setup menu does not appear. This is because Wireless Setup is only supported for new Cisco ISE installations. You can enable Wireless Setup in the Cisco ISE CLI with the command **application configure ise**, picking the option to enable Wireless Setup.
- Wireless Setup requires ports 9103 and 9104 to be open. To close these ports, use the CLI to disable Wireless Setup.
- If you would like to start a fresh installation of Wireless Setup after running some flows, you can use the CLI command **application reset-config ise**. This command resets the Cisco ISE configuration and clears the Cisco ISE database, but keeps the network definitions. So you can reset Cisco ISE and Wireless Setup, without having to reinstall Cisco ISE and running setup.

If you would like to start over with Wireless Setup, you can reset both Cisco ISE and Wireless Setup's configuration with the following steps:

- In the CLI, run **application reset-config** to reset all Cisco ISE configuration. If you were testing Wireless Setup on a fresh installation, this command removes the configurations done by Wireless Setup in Cisco ISE.
- In the CLI, run **application configure ise**, and choose **[18]Reset Config Wi-Fi Setup**. This cleans the Wireless Setup configuration database.
- On the Wireless Controller, remove the configurations added by Wireless Setup on the Wireless Controller. For information about what Wireless Setup configures on the Wireless Controller, see [Changes on Cisco ISE and Wireless Controller by the Wireless Setup flow, on page 40](#).

You can avoid these steps by taking a snapshot of the VM after you finish a fresh installation of Cisco ISE.

For more information about the CLI, see the [Cisco Identity Services Engine CLI Reference Guide](#) for your version of ISE.

- You must be a Cisco ISE Super Admin user to use Wireless Setup.
- Wireless Setup requires at least two CPU cores and 8 GB of memory.
- Only Active Directory (AD) groups and users are supported. After you have created one or more flows in Wireless Setup, other types of users, groups, and authorizations are available for Wireless Setup, but they must be configured on ISE.
- If you already defined Active Directory in Cisco ISE, and you plan to use this AD for Wireless Setup, then:
 - The join name and domain name must be the same. If the names are not the same, then make them the same in Cisco ISE before using that AD in Wireless Setup.
 - If your Wireless Controller is already configured on Cisco ISE, the Wireless Controller must have a shared secret configured. If the Wireless Controller definition does not have the shared secret, then either add the shared secret, or delete the Wireless Controller from Cisco ISE, before configuring that Wireless Controller in Wireless Setup.
- Wireless Setup can configure Cisco ISE components, but it can't delete or modify them after a flow has been started. For a list of all the things that Wireless Setup configures in Cisco ISE, see [Cisco Identity Services Engine CLI Reference Guide](#) for your version of Cisco ISE.
- When you start a flow, you must complete the flow. Clicking a breadcrumb in the flow stops the flow. As you step through a flow, changes are made to the Cisco ISE configuration dynamically. Wireless Setup provides a list of configuration changes, so you can manually revert. You can't back up in a flow to make extra changes, with one exception. You can go back to change Guest or BYOD portal customization.
- Multiple Wireless Controllers and Active Directory domains are supported, but each flow can only support one Wireless Controller and one Active Directory.
- Wireless Setup requires a Cisco ISE Basic license to operate. BYOD requires a Cisco ISE Plus license.
- We recommend that you run Wireless Setup in a standalone setup, with optionally a second node. For more information about what defines a standalone setup, see the [Cisco Identity Services Engine Installation Guide](#) for your version of Cisco ISE.
- If you have configured Cisco ISE resources before configuring Wireless Setup, Wireless Setup may have conflicts with an existing policy. If this happens, Wireless Setup advises you to review the authorization

policy after running through the tool. We recommended that you start with a clean setup of Cisco ISE when running Wireless Setup. Support for a mixed configuration of Wireless Setup and Cisco ISE is limited.

- Wireless Setup is available in English, but not other languages. If you want to use other languages with your portal, configure that in Cisco ISE after running Wireless Setup.
- Dual SSID is supported for BYOD. The Open SSID used in this configuration does not support guest access, due to conflicts. If you need a portal that supports both guest and BYOD, you cannot use Wireless Setup, and is out of the scope of this document.
- **Email and SMS Notifications**
 - For self-registered guests, SMS and email notification is supported. These notifications are configured in the portal customization notification section. You must configure an SMTP server to support SMS and email notifications. The cellular providers built in Cisco ISE, which include AT&T, T Mobile, Sprint, Orange and Verizon, are pre-configured, and are free to email to the SMS gateways.
 - A guest chooses their cell provider in the portal. If their provider is not in the list, then they can't receive a message. You can also configure a global provider, but that is outside of the scope of this guide. If the guest portal is configured for SMS and email notification, then they must enter values for both those services.
 - The Sponsored guest flow does not provide configuration for SMS or email notification in Wireless Setup. For that flow, you must configure notification services in Cisco ISE.
 - Do not select the SMS provider *Global Default* when configuring notifications for a portal. This provider is not configured (by default).
- Wireless setup only supports a standalone setup without HA. If you decide to use extra PSNs for authentication, then add the Cisco ISE IP address of those PSNs to your Wireless Controller's RADIUS configuration.

Wireless Setup Support for Apple Mini-Browser (Captive Network Assistant)

- **Guest Flows:** Auto popup of the Apple pseudo browser works with all Guest Flows. A guest may go through the flow using Apple's Captive Network Assistant browser. When an Apple user connects to the OPEN network, the minibrowser pops-up automatically, which allows them to accept an AUP (hotspot), or to go through self-registration or login with their credentials.
- **BYOD**
 - **Single SSID:** Cisco ISE Release 2.2 added support for the Apple minibrowser. However, to limit potential problems with the SSID flows on Apple devices, we suppressed the minibrowser by adding `captive.apple.com` to the redirection ACL. This causes the Apple device to think it has access to the Internet. The user must manually launch the Safari browser to be redirected to the portal for web authentication or device onboarding.
 - **Dual SSID:** For Dual SSID flow that starts with an initial OPEN network WLAN to start guest access, or to allow your employees to go through Device Onboarding (BYOD), and redirects to a secured SSID, the minibrowser is also suppressed.

For more information about the Apple CAN minibrowser, see <https://communities.cisco.com/docs/DOC-71122>.

- [Configure Wireless Controllers in the Wireless Network, on page 34](#)

- [Active Directory with Wireless Setup, on page 35](#)
- [Guest Portals in Wireless Setup, on page 36](#)
- [Wireless Network Self-Registration Portal, on page 37](#)
- [Wireless Network Sponsored Guest Flow, on page 37](#)
- [Wireless Setup BYOD Flow - For Native Supplicant and Certificate Provisioning, on page 37](#)
- [802.1X Wireless Flow, on page 39](#)
- [Changes on Cisco ISE and Wireless Controller by the Wireless Setup flow, on page 40](#)

Configure Wireless Controllers in the Wireless Network

When you first launch Wireless Setup and select a flow, you are asked to configure a Wireless Controller. Wireless Setup pushes the necessary settings to the Wireless Controller to support the type of flow you are configuring.

- The Wireless Controller must be a Cisco Wireless Controller running AireOS 8.x or higher.
- Virtual Wireless Controller doesn't support DNS based ACLs.
- Configure your Wireless Controller for the interface VLANs (networks) that you plan to use in your Wireless Setup deployment. By default, the Wireless Controller has a management interface, but we recommend that you configure other interfaces for your guest and secure access (employee) networks.
- For the Guest flow, an ACL_WEBAUTH_REDIRECT ACL is used to redirect guest devices to either a Hotspot or Credentialed Portal to acceptance of an AUP (hotspot), to log in, or to create credentials. After the Guest is authorized, they are permitted access (ACCESS-ACCEPT). You can use ACLs on the Wireless Controller to restrict guest permissions. To do so, create an ACL on the Wireless Controller, and use that ACL in your guest permission authorization profile. To allow access to the Cisco ISE success page, add this ACL to the Wireless Controller. For more information about creating restrictive ACLs, see <https://communities.cisco.com/docs/DOC-68169>.
- Wireless Setup configures a WLAN for each flow. Once you have configured a WLAN for a flow, that WLAN is not available for any other flow. The only exception to this is if you configured a WLAN for self-registration flow, and later you decided to use this WLAN for a sponsored guest flow, which handles both self-registration and sponsoring of guests.

If you run Wireless Setup in a production environment, your configurations may disconnect some existing users.

- If you configure a flow in Wireless Setup with a Wireless Controller, do not remove that Wireless Controller in Cisco ISE.
- If you have already configured a Wireless Controller in Cisco ISE, but you didn't configure a shared secret in the RADIUS Options, then you must add a shared secret before using that Wireless Controller in Wireless Setup.
- If you already configured a Wireless Controller in Cisco ISE, and you configured a shared secret, then don't configure a different shared secret with Wireless Setup. The Wireless Setup and the Cisco ISE secret passwords must match. The WLAN that you select is disabled throughout the flow, but it can be re-enabled at the end of the flow by clicking the **Go Live** button.
- **Remote LAN:** If your network has a remote LAN, Wireless Setup fails when it tries to use a VLAN ID that is already assigned to your remote LAN. To work around this, either remove the remote LAN, or

create the VLANs that you plan to use on the Wireless Controller before you run Wireless Setup. In Wireless Setup, you can enable those existing VLANs for flows.

- **FlexConnect:** Flexconnect Local Switch and Flexconnect ACLs are configured by Wireless Setup, but they are not used or supported. Wireless Setup only works with Flexconnect Centralized or Local Mode Access Points and SSIDs.

Example of Wireless Configuration

The following extraction from a Wireless Controller log shows an example of the configuration that Wireless Setup does when you configure a flow.

```
"config radius auth add 1 192.168.201.228 1812 ascii cisco"
"config radius auth disable 1"
"config radius auth rfc3576 enable 1"
"config radius auth management 1 disable"
"config radius auth enable 1"
"config radius acct add 1 192.168.201.228 1813 ascii cisco"
"config radius acct enable 1"
"config acl create ACL_WEBAUTH_REDIRECT"
"config acl rule add ACL_WEBAUTH_REDIRECT 1"
"config acl rule action ACL_WEBAUTH_REDIRECT 1 permit"
"config acl rule source port range ACL_WEBAUTH_REDIRECT 1 53 53"
"config acl rule protocol ACL_WEBAUTH_REDIRECT 1 17"
"config acl rule add ACL_WEBAUTH_REDIRECT 1"
"config acl rule action ACL_WEBAUTH_REDIRECT 1 permit"
"config acl rule destination port range ACL_WEBAUTH_REDIRECT 1 53 53"
"config acl rule protocol ACL_WEBAUTH_REDIRECT 1 17"
"config acl rule add ACL_WEBAUTH_REDIRECT 1"
"config acl rule action ACL_WEBAUTH_REDIRECT 1 permit"
"config acl rule source address ACL_WEBAUTH_REDIRECT 1 192.168.201.228 255.255.255.255"
"config acl rule add ACL_WEBAUTH_REDIRECT 1"
"config acl rule action ACL_WEBAUTH_REDIRECT 1 permit"
"config acl rule destination address ACL_WEBAUTH_REDIRECT 1 192.168.201.228 255.255.255.255"
"config acl apply ACL_WEBAUTH_REDIRECT"
"show flexconnect acl summary"
"config flexconnect acl create ACL_WEBAUTH_REDIRECT"
"config flexconnect acl rule add ACL_WEBAUTH_REDIRECT 1"
"config flexconnect acl rule action ACL_WEBAUTH_REDIRECT 1 permit"
"config flexconnect acl rule source port range ACL_WEBAUTH_REDIRECT 1 53 53"
"config flexconnect acl rule protocol ACL_WEBAUTH_REDIRECT 1 17"
"config flexconnect acl rule add ACL_WEBAUTH_REDIRECT 1"
"config flexconnect acl rule action ACL_WEBAUTH_REDIRECT 1 permit"
"config flexconnect acl rule destination port range ACL_WEBAUTH_REDIRECT 1 53 53"
"config flexconnect acl rule protocol ACL_WEBAUTH_REDIRECT 1 17"
"config flexconnect acl rule add ACL_WEBAUTH_REDIRECT 1"
"config flexconnect acl rule action ACL_WEBAUTH_REDIRECT 1 permit"
"config flexconnect acl rule source address ACL_WEBAUTH_REDIRECT 1 192.168.201.228
255.255.255.255"
"config flexconnect acl rule add ACL_WEBAUTH_REDIRECT 1"
"config flexconnect acl rule action ACL_WEBAUTH_REDIRECT 1 permit"
"config flexconnect acl rule destination address ACL_WEBAUTH_REDIRECT 1 192.168.201.228
255.255.255.255"
"config flexconnect acl apply ACL_WEBAUTH_REDIRECT"
```

Active Directory with Wireless Setup

An Active Directory domain is required to create sponsored guest, 802.1X, and BYOD flows. Active Directory identifies users for the sponsor groups to access the Sponsor portal, 802.1X secure access and associated

VLANs, and BYOD and device onboarding. After configuring any of these flows in Wireless Setup, you can optionally go into Cisco ISE Identities and add:

- An internal sponsor account mapped to a sponsor group, such as ALL_ACCOUNTS. This is not required if you are using Active Directory.
- An employee who is part of the Cisco ISE internal employee group. Make sure that the internal employee group is added to your authorization policy.

Guest Portals in Wireless Setup

When people visiting your company wish to use your company's network to access the internet, or resources and services on your network, you can provide them network access through a Guest portal. Employees can use these Guest portals to access your company's network, if configured.

There are three default Guest portals:

- Hotspot Guest portal: Network access is granted without requiring any credentials. Usually, an Acceptance of User Policy (AUP) must be accepted before network access is granted.
- Sponsored-Guest portal: Network access is granted by a sponsor who creates accounts for guests, and provides the guest with login credentials.
- Self-Registered Guest portal: Guests can create their own account credentials, and may need sponsor approval before they are granted network access.

Cisco ISE can host multiple Guest portals, including a predefined set of default portals.

The default portal themes have standard Cisco branding that you can customize through the Admin portal.

Wireless Setup has its own default theme (CSS) and you are able to modify some basic settings such as logo, banner, background image, coloring and fonts. In Cisco ISE, you can also choose to further customize your portal by changing more settings and going into advanced customizations.

Guest Portal Workflow

1. After you choose the type of portal, you are asked which controller to use. Configure a new wireless network for each flow. You can choose an existing WLAN that you haven't already used in Wireless Setup, or create a new one.

Flows that require redirection have the option of redirecting the user to an originating URL, success page, or specific URL (for example, www.cisco.com). Originating URL requires support from the Wireless Controller.



Note Originating URL is not supported until Wireless Controller version 8.4.

2. Customize the appearance and change the basic settings of the portal.
3. When you're done with customization, follow the URL link to the test portal. The test portal shows you a preview of a test version of the portal. You can continue through the flow, and make more changes, if desired. Note, the only successful redirection that works is for the success page. The originating URL and static URL do not work in the test portal, since they require a wireless session to support the redirect. The

test portal does not support RADIUS sessions, so you won't see the entire portal flow. If you have more than one PSN, Cisco ISE chooses the first active PSN.

4. The configuration is complete. You can download and view the steps that Wireless Setup did for you in Cisco ISE and the Wireless Controller during the workflow.



Note Location is not used for basic guest access in Wireless Setup. Locations are required if you want to control access based on local time. For information about configuring time zones in Cisco ISE, see [SMS Providers and Services, on page 451](#).

Wireless Network Self-Registration Portal

A Self-Registered Guest portal enables guests to register themselves and create their own accounts so they can access the network.

We recommend that you do not choose the logon success page, which displays logon credentials to the user on the screen. The best practice is to get the user credentials via email or SMS, which associates them with something unique for audit purposes.

Wireless Network Sponsored Guest Flow

Sponsors use the Sponsor portal to create and manage temporary accounts for authorized visitors to securely access the corporate network or the internet. After creating a guest account, sponsors can also use the Sponsor portal to provide account details to the guest by printing, emailing, or texting. Before providing self-registration guest access to the company network, sponsors may be requested via email to approve their guests' accounts.

Wireless Setup configures a Sponsor portal and a Sponsored Guest portal during the sponsored flow.

Approval flow is not supported with Wireless Setup.

You map Active Directory groups to your sponsor groups during the workflow. The workflow maps the AD groups you select to the ALL_ACCOUNTS sponsor group. It does not configure the GROUP or OWN account sponsor groups. Optionally, if you want to add other identity sources (such as internal or LDAP settings) you may do this in the Cisco ISE admin UI. For more information, see [Sponsor Groups](#).

Wireless Setup BYOD Flow - For Native Supplicant and Certificate Provisioning

The Bring Your Own Device (BYOD) portal enables employees to register their personal devices. Native supplicant and certificate provisioning can be done before allowing access to the network. Employees do not access the BYOD portal directly, they are redirected to this portal when registering personal devices. The first time employees attempt to access the network using a personal device, they may be prompted to manually download (for non-iOS devices) and launch the Network Setup Assistant (NSA) wizard. The NSA guides them through registering and installing the native supplicant. After they have registered a device, they can use the My Devices portal to manage it.

Wireless Setup configures Cisco ISE and the controller for native supplicant and certificate provisioning. The user makes a PEAP connection to the controller, provides credentials, and the connection is switched to EAP-TLS (certificate).

The following devices are supported with Wireless Setup: Apple Devices (MAC and iOS), Windows Desktop OS (but not mobile), and Android. Chrome OS onboarding is not supported by Wireless Setup.

In the case of Android devices, ensure that the basic authentication access policy is enabled, for single or dual EAP-TLS-based BYOD flows to be successful. Go to **Policy > Policy Sets > Default > Authorization Policy** and ensure that the **Basic_Authenticated_Access** rule is active.



Note Dual SSID flow consists of an open network for onboarding, and a TLS certificate-based secure network for authenticated access. A device can connect to the secure network without onboarding. This is because the **Basic_Authenticated_Access** default rule allows any valid authentication to pass. When the device connects to the secure network, they don't match the BYOD secured authorization rule, the match falls to the bottom of the list to the **Basic_Authenticated_Access** rule.

The fix is to disable the **Basic_Authenticated_Access** rule under authorization policies, or edit the rule to match a specific SSID (WLAN). Both changes block PEAP connections to those that shouldn't allow it.



Note Wireless Setup does not have an authorization rule to redirect devices that are marked as lost. This is done through by blocking the devices, which is managed by the Blacklist portal. For information about managing lost and stolen devices, see http://www.cisco.com/c/en/us/td/docs/solutions/Enterprise/Borderless_Networks/Unified_Access/BYOD_Design_Guide/Managing_Lost_or_Stolen_Device.pdf.

BYOD Flow in Wireless Setup

BYOD Configuration in Wireless Setup consists of the following steps:

1. Choose or register a wireless LAN controller.
2. Add a wireless network.



Note A new Cisco ISE installation includes a default wireless network. With dual SSID BYOD, when the user is redirected to the second SSID, they will also see the default network SSID in their network profile. You can delete the default SSID, or tell your users to ignore it.

3. Choose or join Cisco ISE to an Active Directory (AD): You can override default VLAN settings for both the onboarding VLAN and the final access VLAN. The final access VLAN is mapped to the Active Directory groups.
4. Customize your BYOD Portals: You can customize BYOD and My Devices Portal here. You can customize all the pages that Cisco ISE supports in this step. In this step, all the portal customization is submitted, policies are created and the profiles are linked to the respective policies.



Note The My Devices portal uses basic customization from BYOD portal customization. You cannot customize the My Devices portal in Wireless Setup.

5. Preview the configuration changes made, and click **Done**.

For Dual SSID BYOD

Fast SSID must be enabled to support dual SSID BYOD. When fast SSID changing is enabled, the Wireless Controller allows clients to move faster between SSIDs. When fast SSID is enabled, the client entry is not cleared and the delay is not enforced. For more information about configuring fast SSID on a Cisco Wireless Controller, see the [Cisco Wireless Controller Configuration Guide](#).

Recommended WLC Timer Settings

We recommend setting the following commands on the Wireless Controller that you plan to use in the Wireless Setup.

```
config radius auth retransmit-timeout {SERVER_INDEX} 5
config radius aggressive-failover disable
config radius fallback-test mode passive
config wlan exclusionlist {WLAN ID} 180
config wlan exclusionlist {WLAN ID} enabled
```

802.1X Wireless Flow

Wireless Setup flow configures an 802.1X Wireless Controller with PEAP (username and password credentials).

Part of the flow asks you to specify an Active Directory (AD). You can map employee AD groups to a VLAN. You can configure different employee groups to different VLANs, if you want to separate your groups by VLAN. Click the drop-down next to **Access** to see the AD groups available in the AD you configured.

If you choose AD groups in Wireless Setup, each group is mapped to a VLAN. If an AD group is not mapped to a VLAN, then the user matches the basic access policy, which allows any valid AD user to login.

Employee Connects to Network

1. **Employee Credentials Are Authenticated:** Cisco ISE authenticates the employee against the corporate Active Directory and provides an authorization policy.
2. **Device Is Redirected to the BYOD Portal:** The device is redirected to the BYOD portal. The device's MAC address field is populated, and the user can add a device name and description.
3. **Native Supplicant Is Configured (MacOS, Windows, iOS, Android):** The native supplicant is configured but the process varies by device:
 - MacOS and Windows devices: Employee clicks **Register** in the BYOD portal to download and install the supplicant provisioning wizard. The wizard configures the supplicant, and installs the certificate for EAP-TLS certificate-based authentication. The issued certificate is embedded with the device's MAC address and employee's username.



Note For MacOS, except for Apple certificates, the certificate shows as "unsigned" on the MacOS. This does not affect BYOD flow.

- iOS devices: The Cisco ISE policy server sends a new profile using Apple's iOS over the air to the iOS device, which includes:
 - The issued certificate is stored with the IOS device's MAC address and employee's username.
 - A Wi-Fi supplicant profile that enforces the use of MSCHAPv2 or EAP-TLS for 802.1X authentication.
- Android devices: Cisco ISE prompts and routes employee to download the Cisco Network Setup Assistant (NSA) from the Google Play store. After installing the app, the employee can open NSA and start the setup wizard. The startup wizard generates the supplicant configuration and issued certificate that is used, which is to configure the device.
- **Change of Authorization Issued:** After the user goes through the onboarding flow, Cisco ISE initiates a Change of Authorization (CoA). This causes the MacOSX, Windows, and Android devices to reconnect to the secure 802.1X network using EAP-TLS. For single SSID, iOS devices also connect automatically, but for dual SSID, the wizard prompts iOS users to manually connect to the new network.

Native supplicants are supported for these operating systems:

- Android (excluding Amazon Kindle, B&N Nook)
- MacOS (for Apple Mac computers)
- Apple iOS devices (Apple iPod, iPhone, and iPad)
- Microsoft Windows 7, 8 (excluding RT), Vista, and 10

Changes on Cisco ISE and Wireless Controller by the Wireless Setup flow

Wireless Setup configures Cisco ISE and the controller as you step through a flow. Wireless Setup lists the changes it made at the end of each flow. The changes for each flow are listed here as a reference to help you find all the changes that Wireless Setup made to Cisco ISE, to review or change them.

- **Hotspot**

- **Work Centers > Guest Access > Portals & Components > Guest Portals > Hotspot Portal**
- **Work Centers > Guest Access > Policy Elements > Results > Authorization Profiles**
- **Work Centers > Guest Access > Authorization Policy**

- **Self-Registration**

- **Work Centers > Guest Access > Portals & Components > Guest Portals > Self-reg Portal**

- **Work Centers > Guest Access > Portals & Components > Guest Types > Guest Types**
- **Policy > Policy Elements > Authorization > Authorization Profiles**
- **Work Centers > Guest Access > Authorization Policy**
- **Aministration > System > Settings > SMTP Server**
- **Aministration > System > Settings > SMTP Gateway**

- **Sponsored**
 - **Work Centers > Guest Access > Portals & Components > Guest Portals > Sponsored Guest Portal >**
 - **Work Centers > Guest Access > Portals & Components > Sponsor Portals > > Sponsor Portal >**
 - **Policy > Policy Elements > Authorization > Authorization Profiles**
 - **Work Centers > Guest Access > Authorization Policy**
 - **Work Centers > Guest Access > Portals & Components > Sponsor > Sponsor Groups**
 - **Work Centers > Guest Access > Portals & Components > Guest Types > Guest Types**
 - **Work Centers > Guest Access > Ext ID Sources > Active Directory**

- **BYOD**
 - **Work Centers > BYOD > Portals & Components > BYOD Portals > BYOD Portal**
 - **Work Centers > BYOD > Portals & Components > My Devices Portals > My Devices Portal**
 - **Work Centers > BYOD > Policy Elements > Authorization > Authorization Profiles**
 - **Work Centers > BYOD > Authorization Policy**
 - **Work Centers > BYOD > Ext ID Sources > Active Directory**
 - **Work Centers > BYOD > Ext ID Sources > Active Directory**, then select your AD, then the **Groups** tab.

- **Secure Access**
 - **Policy > Authorization > Authorization Policy**
 - **Policy > Policy Sets**
 - **Work Centers > Guest Access > Ext ID Sources > Active Directory**, then select your AD, then the **Groups** tab.

- **Wireless LAN Controller**
 - **WLANs**
 - **Security > Access Control Lists**: Wireless Setup creates the following ACL:
 - Redirect ACL for guest and BYOD

- Wireless setup also creates entries under **Security > AAA > Authentication and Accounting**



PART II

Deploy Cisco ISE Nodes

- [Set Up Cisco ISE in a Distributed Environment, on page 45](#)



CHAPTER 4

Set Up Cisco ISE in a Distributed Environment

- [Cisco ISE Deployment Terminology, on page 45](#)
- [Personas in Distributed Cisco ISE Deployments, on page 46](#)
- [Cisco ISE Distributed Deployment, on page 46](#)
- [Configure a Cisco ISE Node, on page 49](#)
- [Administration Node, on page 53](#)
- [Policy Service Node, on page 60](#)
- [Monitoring Node, on page 61](#)
- [Cisco pxGrid Node, on page 63](#)
- [View Nodes in a Deployment, on page 69](#)
- [Synchronize Primary and Secondary Cisco ISE Nodes, on page 69](#)
- [Change Node Personas and Services, on page 69](#)
- [Effects of Modifying Nodes in Cisco ISE , on page 70](#)
- [Create a Policy Service Node Group, on page 70](#)
- [Configure MnT Nodes for Automatic Failover, on page 71](#)
- [Remove a Node from Deployment, on page 72](#)
- [Shut Down a Cisco ISE Node, on page 73](#)
- [Change the Hostname or IP Address of a Standalone Cisco ISE Node, on page 73](#)
- [Replace the Cisco ISE Appliance Hardware, on page 74](#)

Cisco ISE Deployment Terminology

The following terms are commonly used when discussing Cisco ISE deployment scenarios:

- **Service:** A service is a specific feature that a persona provides, such as network access, profiler, posture, security group access, monitoring and troubleshooting, and so on.
- **Node:** A node is an individual instance that runs the Cisco ISE software. Cisco ISE is available as an appliance and also as a software that can be run on VMware. Each instance (appliance or VMware) that runs the Cisco ISE software is called a node.
- **Persona:** The persona of a node determines the services provided by the node. A Cisco ISE node can assume any of the following personas-Administration, Policy Service, Monitoring, and pxGrid. The menu options that are available through the Admin portal are dependent on the role and personas that a Cisco ISE node assumes.

- Deployment Model: Determines if your deployment is distributed, standalone, or high availability in standalone, which is a basic two-node deployment.

Personas in Distributed Cisco ISE Deployments

A Cisco ISE node can assume the Administration, Policy Service, or Monitoring personas.

A Cisco ISE node can provide various services based on the persona that it assumes. Each node in a deployment can assume the Administration, Policy Service, and Monitoring personas. In a distributed deployment, you can have the following combination of nodes in your network:

- Primary Policy Administration Node (primary PAN) and secondary Policy Administration Node (secondary PAN) for high availability
- Primary Monitoring Node (primary MnT node) and Secondary Monitoring Node (secondary MnT node) for high availability
- A pair of health check nodes or a single health check node for the primary PAN automatic failover
- One or more Policy Service Nodes (PSNs) for the session failover

Environment download is successful, with only the up-and-running Cisco ISE node present in the result.

Cisco ISE Distributed Deployment

A deployment that has more than one Cisco ISE node is called a distributed deployment. To support failover and to improve performance, you can set up your deployment with multiple Cisco ISE nodes in a distributed fashion. In a Cisco ISE distributed deployment, the administration and monitoring activities are centralized, and processing is distributed across the PSNs. Depending on your performance needs, you can scale your deployment. Each Cisco ISE node in a deployment can assume any of the following personas: Administration, Policy Service, and Monitoring.

Cisco ISE Deployment Setup

After you install Cisco ISE on all your nodes, as described in the [Cisco Identity Services Engine Hardware Installation Guide](#), the nodes come up in a standalone state. You must then define one node as your primary PAN. While defining your primary PAN, you must enable the administration and monitoring personas on that node. You can optionally enable the policy service persona on the primary PAN. After you complete the task of defining personas on the primary PAN, you can register other secondary nodes to the primary PAN and define personas for the secondary nodes.

All Cisco ISE system and functionality-related configurations should be done only on the primary PAN. The configuration changes that you perform on the primary PAN are replicated to all the secondary nodes in your deployment.

There must be at least one MnT in a distributed deployment. At the time of configuring your primary PAN, you must enable the Monitoring persona. After you register an MnT node in your deployment, you can edit the primary PAN and disable the Monitoring persona, if required.

Data Replication from Primary to Secondary ISE Nodes

When you register a Cisco ISE node as a secondary node, Cisco ISE immediately creates a data replication channel from the primary to the secondary node and begins the process of replication. Replication is the process of sharing Cisco ISE configuration data from the primary to the secondary nodes. Replication ensures consistency among the configuration data available in all the Cisco ISE nodes that are part of your deployment.

A full replication typically occurs when you first register a Cisco ISE node as a secondary node. Incremental replication occurs after a full replication and ensures that any new changes, such as additions, modifications, or deletions to the configuration data in the PAN are reflected in the secondary nodes. The process of replication ensures that all the Cisco ISE nodes in a deployment are in sync. You can view the status of replication in the **Node Status** column in the **Deployment** window of the Cisco ISE Admin portal. When you register a Cisco ISE node as a secondary node or perform a manual synchronization with the PAN, the node status shows an orange icon, indicating that the requested action is in progress. After the synchronization is complete, the node status turns green, indicating that the secondary node is synchronized with the PAN.

Cisco ISE Node Deregistration

To remove a node from a deployment, you must deregister it. When you deregister a secondary node from the primary PAN, the status of the deregistered node changes to standalone, and the connection between the primary and the secondary node is lost. Replication updates are no longer sent to the deregistered standalone node.

When a PSN is deregistered, the endpoint data is lost. If you want the PSN to retain the endpoint data after it becomes a standalone node, you can do one of the following:

- Obtain a backup from the primary PAN, and when the PSN becomes a standalone node, restore this data backup on it.
- Change the persona of the PSN to administration (secondary PAN), synchronize the data from the **Deployment** window of the Admin portal, and then deregister the node. This node will now have all the data. You can then add a secondary PAN to the existing deployment.



Note You cannot deregister a primary PAN.

Guidelines for Setting Up a Distributed Deployment

Read the following statements carefully before you set up Cisco ISE in a distributed environment:

- Choose a node type for the Cisco ISE server. You must choose a Cisco ISE node for administration, policy service, and monitoring capabilities.
- Choose the same Network Time Protocol (NTP) server for all the nodes. To avoid timezone issues among the nodes, you must provide the same NTP server name during the setup of each node. This setting ensures that the reports and logs from the various nodes in your deployment are always synchronized with timestamps.
- Configure the Cisco ISE administrator password when you install Cisco ISE. The previous Cisco ISE administrator default login credentials (admin/cisco) are no longer valid. Use the username and password that was created during the initial setup or the current password if it was changed later.

- Configure the DNS server. Enter the IP addresses and fully qualified domain names (FQDNs) of all the Cisco ISE nodes that are part of your distributed deployment in the DNS server. Otherwise, node registration fails.
- Configure the forward and the reverse DNS lookup for all the Cisco ISE nodes in your distributed deployment in the DNS server. Otherwise, you may run into deployment-related issues when registering and restarting Cisco ISE nodes. Performance might be degraded if reverse DNS lookup is not configured for all the nodes.
- (Optional) Deregister a secondary Cisco ISE node from the primary PAN to uninstall Cisco ISE from it.
- Back up the primary MnT, and restore the data to the new secondary MnT. This ensures that the history of the primary MnT is in sync with the new MnT because the new changes are replicated.
- Ensure that the primary PAN and the standalone node that you are about to register as a secondary node are running the same version of Cisco ISE.
- Enable **Internal CA Settings** on your Cisco ISE primary PAN before you add another node to your deployment to ensure that the Cisco ISE certificate services function as expected. To enable Internal CA Settings, choose **Administration > System > Certificates > Certificate Authority > Internal CA Settings**. See [Cisco ISE CA Service, on page 165](#).
- While adding a new node to the deployment, make sure that the issuer certificate chain of wildcard certificates is part of the trusted certificates of the new node. When the new node is added to the deployment, the wildcard certificates are then replicated to the new node.
- When configuring your Cisco ISE deployment to support Cisco TrustSec, or when Cisco ISE is integrated with Cisco DNA Center, do not configure a PSN as SXP-only. SXP is an interface between Cisco TrustSec and non-Cisco TrustSec devices. SXP does not communicate with the Cisco TrustSec-enabled network devices.

Menu Options Available on Primary and Secondary Nodes

The menu options that are available in Cisco ISE nodes that are a part of a distributed deployment depend on the personas that are enabled on them. You must perform all administration and monitoring activities through the primary PAN. For other tasks, you must use the secondary nodes. Therefore, the user interface of the secondary nodes provides limited menu options based on the persona that is enabled on them.

If a node assumes more than one persona, for example, the Policy Service persona, and a Monitoring persona with a primary role, then the menu options listed for the PSNs and the primary MnT are available on that node.

The following table lists the menu options that are available on the Cisco ISE nodes that assume different personas.

Table 4: Cisco ISE Nodes and Available Menu Options

Cisco ISE Node	Available Menu Options
All Nodes	<ul style="list-style-type: none"> View and configure the system time and the NTP server settings Install the server certificate and manage certificate signing request. You can perform server certificate operations for all the nodes in the deployment through the primary PAN that centrally manages all the server certificates <p>Note The private keys are not stored in the local database and are not copied from the relevant node. The private keys are stored in the local file system.</p>
Primary Policy Administration node (primary PAN)	All menus and submenus
Primary Monitoring node (primary MnT node)	<ul style="list-style-type: none"> Provides access to monitoring data <p>Note The Operations menu can be viewed only from the primary PAN. The Operations menu does not appear in the monitoring nodes in Cisco ISE 2.1 and later.</p>
PSNs (Policy Service nodes)	Options to join, leave, and test the Active Directory connection are available. Each PSN must be separately joined to the Active Directory domain. You must first define the domain information and join the PAN to the Active Directory domain. Then, join the other PSNs to the Active Directory domain individually.
Secondary Policy Administration node (secondary PAN)	<p>Option to promote the secondary PAN to primary PAN.</p> <p>Note After you have registered the secondary nodes to the primary PAN, while logging in to the Admin portal of any of the secondary nodes, you must use the login credentials of the primary PAN.</p>

Configure a Cisco ISE Node

After you install a Cisco ISE node, all the default services provided by the Administration, Policy Service, and Monitoring personas run on it. This node is in a standalone state. You must log in to the Admin portal of the Cisco ISE node to configure it. You cannot edit the personas or services of a standalone Cisco ISE node.

You can, however, edit the personas and services of the primary and secondary Cisco ISE nodes. You must first configure a primary ISE node and then register secondary ISE nodes to the primary ISE node.

If you are logging in to the node for the first time, you must change the default administrator password and install a valid license.

We recommend that you do not change the host name and the domain name configured on Cisco ISE in production. If required, reimage the appliance, make changes, and configure the details during the initial deployment.

Before you begin

You should have a basic understanding of how distributed deployments are set up in Cisco ISE. See [Guidelines for Setting Up a Distributed Deployment](#).

-
- Step 1** Choose **Administration** > **System** > **Deployment**.
 - Step 2** Check the check box next to the Cisco ISE node that you want to configure, and click **Edit**.
 - Step 3** Enter the values, as required, and click **Save**.
-

Configure a Primary Policy Administration Node (PAN)

To set up a distributed deployment, you must first configure a Cisco ISE node as your primary PAN.

-
- Step 1** Choose **Administration** > **System** > **Deployment**.
The **Register** button is disabled initially. To enable this button, you must configure a primary PAN.
 - Step 2** Check the check box next to the current node, and click **Edit**.
 - Step 3** Click **Make Primary** to configure your primary PAN.
 - Step 4** Click **Save** to save the node configuration.
-

What to do next

1. Add secondary nodes to your deployment.
2. Enable the profiler service and configure the probes, if required.

Install Trusted Certificates for Cisco ISE Inter Node Communication

When you set up the deployment, before you register a secondary node, you must populate the PAN's CTL with appropriate CA certificates that are used to validate the Admin certificate of the secondary node. The procedure to populate the CTL of the PAN is different for different scenarios:

- If the secondary node is using a CA-signed certificate to communicate with the Cisco ISE administration portal, you must import the CA-signed certificate of the secondary node, the relevant intermediate certificates (if any), and the root CA certificate (of the CA that signed the secondary node's certificate) into the CTL of the PAN.

- If the secondary node is using a self-signed certificate to communicate with the Cisco ISE administration portal, you can import the self-signed certificate of the secondary node into the CTL of the PAN.

**Note**

- If you change the Admin certificate on a registered secondary node, you must obtain appropriate CA certificates that can be used to validate the secondary node's Admin certificate and import it into the CTL of the PAN.
- If you use self-signed certificates to secure communication between a client and PSN in a deployment, when BYOD users move from one location to another, EAP-TLS user authentication fails. For such authentication requests that have to be serviced between a few PSNs, you must secure communication between the client and the PSN with an externally-signed CA certificate or use wildcard certificates signed by an external CA.

Ensure that the certificate issued by the external CA has basic constraints defined and the CA flag is set to true. To install CA-signed certificates for inter-node communication:

-
- Step 1** [Create a Certificate-Signing Request and Submit it to a Certificate Authority, on page 158](#)
 - Step 2** [Import a Root Certificate to Trusted Certificate Store, on page 156](#)
 - Step 3** [Bind a CA-Signed Certificate to a Certificate Signing Request, on page 158](#)
-

Register a Secondary Cisco ISE Node

After you register the secondary node, the configuration of the secondary node is added to the database of the primary node and the application server on the secondary node is restarted. After the restart is complete, the secondary node will be running the personas and services that you have enabled on it. You can view all the configuration changes that you make from the Deployment page of the Primary PAN. However, expect a delay of 5 minutes for your changes to take effect and appear on the Deployment page.

Before you begin

Ensure that the primary node's trusted certificate store has the appropriate certificate authority (CA) certificates to validate the HTTPS certificate of the secondary node that you are going to register. When you import the secondary node's certificate in to the trusted certificate store, check the **Trust for authentication within ISE** check box for the Primary PAN to validate the secondary node's certificate.

After you register the secondary node to the primary node, if you change the HTTPS certificate on the secondary node, you must import the appropriate CA certificates into the trusted certificate store of the primary node.

The certificates that you import into the trusted certificate store of the Primary PAN are replicated to the secondary nodes.

If you plan to deploy two Administration nodes for high availability, register the Secondary PAN before you register the other secondary nodes. If you register the nodes in this sequence, you do not have to restart the secondary ISE nodes after you promote the Secondary PAN as your primary.

If you plan to deploy multiple Policy Service nodes running Session services with mutual failover among these nodes, place the Policy Service nodes in a node group. You must create the node group before you register the nodes.

Step 1 Log in to the Primary PAN.

Step 2 Choose **Administration > System > Deployment**.

Step 3 Choose **Register > Register an ISE Node** to register a secondary node.

Step 4 Enter the DNS-resolvable hostname of the secondary node.

If you are using the hostname while registering the Cisco ISE node, the fully qualified domain name (FQDN) of the standalone node that you are going to register, for example, *abc.xyz.com*, must be DNS-resolvable from the Primary PAN. Otherwise, node registration fails. You must have previously defined the IP address and the FQDN of the secondary node in the DNS server.

Step 5 Enter a UI-based administrator credential for the secondary node in the Username and Password fields.

Step 6 Click **Next**.

Cisco ISE contacts the secondary node, obtains some basic information such as the hostname, default gateway, and so on, and displays it.

If you have chosen to register a secondary node, you can edit the configuration of the secondary node.

Step 7 Click **Save**.

After a secondary node is registered successfully, you will receive an alarm on your Primary PAN that confirms a successful node registration. If the secondary node fails to register with the Primary PAN, the alarm is not generated. When a node is registered, the application server on that node is restarted. After successful registration and database synchronization, enter the credentials of the Primary PAN to log in to the user interface of the secondary node.



Note In addition to the existing Primary node in the deployment, when you successfully register a new node, no alarm corresponding to the newly registered node is displayed. The Configuration Changed alarms reflect information corresponding to the newly registered nodes. You can use this information to ascertain the successful registration of the new node.

What to do next

- For time-sensitive tasks such as guest user access and authorization, logging, and so on, ensure that the system time on your nodes is synchronized.
- If you registered a Secondary PAN, and will be using the internal Cisco ISE CA service, you must back up the Cisco ISE CA certificates and keys from the Primary PAN and restore them on the Secondary PAN.

See [Backup and Restoration of Cisco ISE CA Certificates and Keys, on page 173](#)

Administration Node

A Cisco ISE node with the Administration persona allows you to perform all administrative operations on Cisco ISE. It handles all the system-related configurations that are related to functionalities such as authentication, authorization, auditing, and so on. In a distributed environment, you can have a maximum of two nodes running the Administration persona. The Administration persona can take on of these following roles-Standalone, Primary, or Secondary.

High Availability for the Administrative Node

In a high-availability configuration, the primary Policy Administration Node (PAN) is in the active state. The secondary PAN is in the standby state, which means it receives all configuration updates from the primary PAN, but is not active in the Cisco ISE network.

Cisco ISE supports manual and automatic failover. With automatic failover, when the primary PAN goes down, an automatic promotion of the secondary PAN is initiated. Automatic failover requires a nonadministration secondary node, which is called a health check node. The health check node checks the health of the primary PAN. If the health check node detects that the primary PAN is down or unreachable, it initiates the promotion of the secondary PAN to take over the primary role.

To deploy the Automatic Failover feature, you must have at least three nodes, with two of them assuming the Administration persona, and one acting as the health check node. A health check node is a nonadministration node and can be a PSN, MnT, pxGrid node, or a combination of these. If the primary and secondary PANs are in different data centers, you must have a health check node for each PAN.

The following table lists the features that are affected when the primary PAN goes down and the secondary PAN is yet to take over.

Features Name	Available When Primary PAN is Down? (Yes/No)
Existing internal user RADIUS authentication	Yes
Existing or new AD user RADIUS authentication	Yes
Existing endpoint with no profile change	Yes
Existing endpoint with profile change	No
New endpoint learned through profiling.	No
Existing guest: Local Web Authentication (LWA)	Yes
Existing guest: Central Web Authentication (CWA)	Yes (apart from flows enabled for device registration, such as Hotspot, BYOD, and CWA with automatic device registration)
Guest change password	No
Guest: AUP	No
Guest: Max Failed Login Enforcement	No
New Guest (Sponsored or Self-registered)	No

Features Name	Available When Primary PAN is Down? (Yes/No)
Posture	Yes
BYOD with Internal CA	No
Existing Registered Devices	Yes
MDM on-boarding	No
pxGrid Service	No
Log in to GUI of secondary nodes	Yes (The login process is delayed because a blocking call to the PAN is attempted to update the last login details. The login proceeds after this call times out.)

To support certificate provisioning with the internal certificate authority, you must to import the root certificate of the original primary PAN and its key into the new primary node, after promotion. Certificate provisioning does not work after automatic failover for the PSN nodes that are added after the promotion of the secondary node to primary PAN.

High-Availability Health Check Nodes

The health check node for Primary PAN is called the active health check node. The health check node for Secondary PAN is called the passive health check node. The active health check node is responsible for checking the status of the Primary PAN, and managing the automatic failover of Administration nodes. We recommend that you use two nonadministrative ISE nodes as health check nodes, one for the Primary PAN and one for the Secondary PAN. If you use only one health check node, and that node goes down, automatic failover will not happen.

When both the PANs are in the same data center, you can use a single nonadministrative ISE node as the health check node for both the Primary PAN and the Secondary PAN. When a single health check node checks the health of both the Primary PAN and the Secondary PAN, it assumes both the active and passive roles.

A health check node is a nonadministration node, which means it can be a Policy Service, Monitoring, or pxGrid node, or a combination of those. We recommend that you designate PSN nodes as health check nodes in the same data center as the Administration nodes. However, in a small or a centralized deployment, where the two Administration nodes are not in the same location (LAN or data center), any node (PSN, pxGrid, or MnT) not having the Administration persona can be used as health check node.



Note If you chose not to enable automatic failover, and rely on manually promoting the secondary node when the primary PAN fails, you do not need any check nodes.

Health Check Node for the Secondary PAN

The health check node for the Secondary PAN is a passive monitor. It does not take any action until the Secondary PAN has been promoted as the Primary PAN. When the Secondary PAN takes over the primary role, its associated health check node takes the active role for managing automatic failover of Administration nodes. The health check node of the previous Primary PAN becomes the health check node for the Secondary PAN now and monitors it passively.

Disabling and Restarting Health Check

When a node is removed from the health check role or auto-failover configuration is disabled, the health check service is stopped on that node. When the auto-failover configuration is enabled on the designated high-availability health check node, the node starts checking the health of Administration nodes again. Designating or removing the high-availability health check role on a node does not involve any application restart on that node; only the health check activities are started or stopped.

If the high-availability health check node is restarted, it ignores the previous downtimes of the Primary PAN and starts checking the health status afresh.

Health Check Nodes

The active health check node checks the health status of the primary PAN at a configured polling interval. It sends a request to the primary PAN, and if the response that it receives matches the configuration, the health check node considers the primary PAN to be in good health. If the health of the primary PAN is bad continuously for more than the configured failover period, the health check node initiates failover to the secondary PAN.

If, at any time during a health check, the health status is found to be good after being reported as bad previously within the failover period, the health check node marks the primary PAN status as good, and resets the health check cycle.

The response from the health check of the primary PAN is validated against the configuration values available on its health check node. If the response does not match, it raises an alarm. However, a promotion request is made to the secondary PAN.

Changing Health Nodes

You can change the Cisco ISE node that you are using for a health check, but there are some things to consider.

For example, assume that the health check node (H1) goes out-of-sync and some other node (H2) is made the health check node of the primary PAN. In such a case, after the primary PAN goes down, there is no way for H1 to know that another node (H2) is checking the same primary PAN. Later, if H2 goes down or out of the network, an actual failover is required. The secondary PAN, however, retains the right to reject the promotion request. So, after the secondary PAN is promoted to the primary role, a promotion request from H2 is rejected with an error. Even if a health check node for the primary PAN is out of sync, it continues to check the health of the primary PAN.

Automatic Failover to the Secondary PAN

You can configure Cisco ISE to automatically promote the secondary PAN when the primary PAN becomes unavailable. The configuration is done on the primary Policy Administration node (Primary PAN) in the **Deployment** window. The navigation path for this window is **Administration > System > Deployment**. The failover period is defined as the number of times configured in **Number of Failure Polls Before Failover** times the number of seconds configured in **Polling Interval**. In the default configuration, that time is 10 minutes. Promotion of the secondary PAN to primary PAN takes another 10 minutes. So, by default, the total time from primary PAN failure to secondary PAN working is 20 minutes.

When the secondary PAN receives the failover call, it carries out the following validations before proceeding with the actual failover:

- The primary PAN is not available in the network.

- The failover request came from a valid health check node.
- The failover request is for the secondary PAN.

If all the validations pass, the secondary PAN promotes itself to the primary role.

The following are some sample (but not limited to) scenarios where automatic failover of the secondary PAN can be attempted:

- Health of the primary PAN is consistently not good for the **Number of failure polls before failover** value during the polling period.
- Cisco ISE services on the primary PAN are manually stopped, and remain stopped for the failover period.
- The primary PAN is shut down using soft halt or reboot option, and remains shut down for the configured failover period.
- The primary PAN goes down abruptly (power down), and remains down for the failover period.
- The network interface of the primary PAN is down (network port shut or network service down), or it is not reachable by the health check node for any other reason, and remains down for the configured failover period.

Health Check Node Restarts

Upon restart, the high-availability health check node ignores the previous downtimes of the primary PAN and checks the health status afresh.

Bring Your Own Device in Case of Automatic Failover to Secondary PAN

When the primary PAN is down, authentication is not interrupted for the endpoints that already have certificates issued by the primary PAN root CA chain. This is because all the nodes in the deployment have the entire certificate chain for trust and validation purposes.

However, until the secondary PAN is promoted to primary, new BYOD devices will not be onboarded. BYOD onboarding requires an active primary PAN.

After the original primary PAN is brought back up or the secondary PAN is promoted, new BYOD endpoints are onboarded without any issues.

If the primary PAN that failed can not be rejoined as the primary PAN, regenerate the root CA certificate on the newly promoted primary PAN (the original secondary PAN).

For existing certificate chains, triggering a new root CA certificate results in the automatic generation of the subordinate CA certificates. Even when new subordinate certificates are generated, endpoint certificates that were generated by the previous chain continue to be valid.

Sample Scenarios when Automatic Failover is Avoided

The following are some sample scenarios that depict cases where automatic failover by the health check node might be avoided or promotion request to the secondary node rejected:

- The node receiving the promotion request is not the secondary node.
- The promotion request received by the secondary PAN does not have the correct primary PAN information.
- The promotion request is received from an incorrect health check node.

- The promotion request is received, but the primary PAN is up and in good health.
- The node receiving the promotion request goes out-of-sync.

Functionalities Affected by the PAN Automatic Failover Feature

The following table lists the functionalities that are blocked or require additional configuration changes if the PAN automatic failover configuration is enabled in your deployment.

Functionality	Affected Details
Operations that are Blocked	
Upgrade	<p>Upgrade through the CLI is blocked.</p> <p>The PAN Automatic Failover feature is available for configuration after you upgrade from an earlier release to Cisco ISE, Release 1.4. By default, this feature is disabled.</p> <p>To deploy the Auto-Failover feature, you must have at least three nodes, where two of the nodes assume the Administration persona, and one node acts as the health check node. (A health check node is a nonadministration node and can be a PSN, MnT, pxGrid node, or a combination of these). If the PANs are in different data centers, you must have a health check node for each PAN.</p>
Restore of Backup	<p>Restore through the CLI and user interface is blocked.</p> <p>If the PAN automatic failover configuration was enabled prior to restore, you must reconfigure it after a successful restore.</p>
Change Node Persona	<p>Change of the following node personas through the GUI is blocked:</p> <ul style="list-style-type: none"> • Administration persona in both the primary and secondary PANs • Persona of the PAN • Deregistration of health check node after enabling the PAN Automatic Failover feature

Functionality	Affected Details
Other CLI Operations	<p>The following admin operations through the CLI is blocked:</p> <ul style="list-style-type: none"> • Patch installation and roll back • DNS server change • IP address change of eth1, eth2, and eth3 interfaces • Host alias change of eth1, eth2, and eth3 interfaces • Time zone change
Other Administration Portal Operations	<p>The following administrative operations through the GUI is blocked:</p> <ul style="list-style-type: none"> • Patch installation and roll back • Change of HTTPS certificate • Change of admin authentication type from password-based authentication to certificate-based authentication and vice versa
Users with maximum connected devices cannot connect.	Some session data is stored on the failed PAN, and cannot be updated by the PSN.
Operations that Require PAN Automatic Failover to be Disabled	
CLI Operations	<p>The following administrative operations through the CLI display a warning message if the PAN automatic failover configuration is enabled. These operations may trigger automatic failover if service or system is not restarted within the failover window. Hence, while performing the following operations, we recommend that you to disable the PAN automatic failover configuration:</p> <ul style="list-style-type: none"> • Manual stopping the Cisco ISE service • Soft reload (reboot) of Cisco ISE using the admin CLI

Configure Primary PAN for Automatic Failover

Before you begin

To deploy the Automatic Failover feature, you must have at least three nodes, where two of the nodes assume the Administration persona, and one node acts as the health check node. A health check node is a

nonadministration node and can be a PSN, MnT, pxGrid node, or a combination of these. If the PANs are in different data centers, you must have a health check node for each PAN.

-
- Step 1** Log in to the primary PAN GUI.
- Step 2** Choose **Administration > System > Deployment > PAN Failover**.
- Step 3** Check the **Enable PAN Auto Failover** check box to enable automatic failover of the primary PAN.
- Note** You can only promote a secondary PAN to become the Primary PAN. Cisco ISE nodes that assume only the PSN, MnT, pxGrid node, or a combination of these, cannot be promoted to become the Primary PAN.
- Step 4** Choose the health check node for the primary PAN from the **Primary Health Check Node** drop-down list containing all the available secondary nodes.
- We recommend that you have this node in the same location or data center as the primary PAN.
- Step 5** Choose the health check node for the secondary PAN, from the **Secondary Health Check Node** drop-down list containing all the available secondary nodes.
- We recommend that you have this node in the same location or data center as the secondary PAN.
- Step 6** Provide the **Polling Interval** time after which the PAN status is checked. The valid range is 30 to 300 seconds.
- Step 7** Provide the count for **Number of Failure Polls before Failover**.
- Failover occurs if the status of the PAN is not good for the specified number of failure polls. The valid range is 2 to 60 counts.
- Step 8** Click **Save**.

What to do next

After the promotion of the secondary PAN to the primary PAN, do the following:

- Manually sync the old primary PAN to bring it back into the deployment.
- Manually sync any other secondary node that is out of sync, to bring it back into the deployment.

Manually Promote Secondary PAN to Primary

If the primary PAN fails and you have not configured PAN automatic failover, you must manually promote the secondary PAN to become the new primary PAN.

Before you begin

Ensure that you have a second Cisco ISE node configured with the Administration persona to promote as your primary PAN.

-
- Step 1** Log in to the secondary PAN GUI.
- Step 2**
- Step 3** In the **Edit Node** window, click **Promote to Primary**.

Note You can only promote a secondary PAN to become the primary PAN. Cisco ISE nodes that assume only the Policy Service or Monitoring persona, or both, cannot be promoted to become the primary PAN.

Step 4 Click **Save**.

What to do next

If the node that was originally the primary PAN, comes back up, it will be demoted automatically and become the secondary PAN. You must perform a manual synchronization on this node (that was originally the primary PAN) to bring it back into the deployment.

In the **Edit Node** window of a secondary node, you cannot modify the personas or services because the options are disabled. You have to log in to the Admin portal to make changes.

Restoring Service to the Primary PAN

Cisco ISE does not support automatic fallback to the original primary PAN. After the automatic failover to the secondary PAN is initiated, if you bring the original primary PAN back into the network, you should configure it as the secondary PAN.

Policy Service Node

A Policy Service node (PSN) is a Cisco ISE node with the Policy Service persona, and provides network access, posture, guest access, client provisioning, and profiling services.

At least one node in your distributed setup should assume the Policy Service persona. This persona evaluates the policies and makes all the decisions. Typically, there is more than one PSN in a distributed deployment.

All the PSNs that reside in the same high-speed Local Area Network (LAN) or behind a load balancer can be grouped together to form a node group. If one of the nodes in a node group fails, the other nodes detect the failure and reset URL-redirectioned sessions, if any.

High Availability in Policy Service Nodes

To detect node failure and to reset all URL-redirectioned sessions on the failed node, two or more PSNs can be placed in the same node group. When a node that belongs to a node group fails, another node in the same node group issues a Change of Authorization (CoA) for all URL-redirectioned sessions on the failed node.

All the nodes within the same node group should be configured on the network access device (NAD) as RADIUS clients and authorized for CoA, because any one of them can issue a CoA request for the sessions that are established through any node in the node group. If you are not using a load balancer, the nodes in a node group should be the same as, or a subset of, the RADIUS servers and clients configured on the NAD. These nodes should also be configured as RADIUS servers.



Note While a single NAD can be configured with many Cisco ISE nodes as RADIUS servers and dynamic-authorization clients, it is not necessary for all the nodes to be in the same node group.

The members of a node group should be connected to each other using high-speed LAN connection such as Gigabit Ethernet. The node group members need not be L2 adjacent, but L2 adjacency is highly recommended to ensure sufficient bandwidth and reachability. See [Create a Policy Service Node Group, on page 70](#) section for more details.

Load Balancer to Distribute Requests Evenly Among PSNs

When you have multiple PSNs in the deployment, you can use a load balancer to distribute the requests evenly. The load balancer distributes the requests to the functional nodes behind it. See [Cisco and F5 Deployment Guide: ISE Load Balancing using BIG-IP](#) for information, and to know about best practices when deploying PSNs behind a load balancer.

Session Failover in Policy Service Nodes

PSNs in a node group share session information. The nodes exchange heartbeat messages to detect node failures. If a node fails, one of its peers from the node group knows which sessions were on the failed PSN, and issues a CoA to disconnect those sessions. Most clients automatically reconnect, and establish a new session.

Some clients don't automatically reconnect. For example, if a client connects through a VPN, then that client may not see the CoA. Clients that are IP phones, multihost 802.1X ports, or virtual machines may also not see or be able to respond to a CoA. URL-redirectioned clients (webauth) also can't connect automatically. Those clients must manually reconnect.

Timing issues can also prevent reconnection, for example, if the posture state is pending at the time of PSN failover.

The PSNs in a distributed deployment don't share their Machine Access Restriction (MAR) cache with each other. If you have enabled the MAR feature in Cisco ISE, a client machine is authenticated by a PSN, and that PSN fails, then another PSN in the deployment handles the user authentication. However, the user authentication fails because the second PSN doesn't have the host authentication information in its MAR cache.

Number of Nodes in a Policy Service Node Group

The number of nodes that you can have in a node group depends on your deployment requirements. Node groups ensure that node failures are detected and that a peer issues a CoA for sessions that are authorized, but not yet postured. The size of the node group does not have to be very large.

If the size of the node group increases, the number of messages and heartbeats that are exchanged between the nodes increases significantly. As a result, traffic also increases. Having fewer nodes in a node group helps reduce the traffic and at the same time provides sufficient redundancy to detect PSN failures.

There is no hard limit on the number of PSNs that you can have in a node group cluster.

Monitoring Node

A Cisco ISE node with the Monitoring persona functions as the log collector and stores log messages from the PANs and PSNs in your network. This persona provides advanced monitoring and troubleshooting tools that you can use to effectively manage your network and resources. A node with this persona aggregates and correlates the data that it collects to provide you with meaningful information in the form of reports.

Cisco ISE allows you to have a maximum of two nodes with this persona that can take on primary or secondary roles for high availability. Both the primary and secondary MnT nodes collect log messages. If the primary MnT goes down, the primary PAN points to the secondary node to gather monitoring data. But the secondary node will not be promoted to primary automatically. This should be done by following the procedure described in [Manually Modify the MnT Role](#).

At least one node in your distributed setup should assume the Monitoring persona. We recommend that you not have the Monitoring and Policy Service personas enabled on the same Cisco ISE node, and that the node be dedicated solely to monitoring, for optimum performance.

You can access the Monitoring menu from the PAN in your deployment.

Manually Modify the MnT Role

You can manually modify MnT roles (both from primary to secondary and from secondary to primary) from the primary PAN.

-
- Step 1** Log in to the primary PAN GUI.
 - Step 2** Choose **Administration > System > Deployment**.
 - Step 3** From the list of nodes, check the check box next to the MnT node for which you want to change the role.
 - Step 4** Click **Edit**.
 - Step 5** In the **Monitoring** section, change the role to **Primary** or **Secondary**.
 - Step 6** Click **Save**.
-



Note You can enable the option if you want to disable all the other personas and services enabled on that node. When this option is enabled, the configuration data replication process is stopped on that node. This helps to improve the performance of the MnT node. When you disable this option, manual synchronization is triggered.

Automatic Failover in MnT Nodes

MnT nodes do not offer high availability, but do offer active standby. The PSN copies operational audit data to both the primary and secondary MnT nodes.

Automatic Failover Process

When a primary MnT node goes down, the secondary MnT node takes over all the monitoring and troubleshooting information.

To manually convert the secondary node to a primary node, see [Manually Modify the MnT Role](#). If the primary node comes up again after the secondary node is promoted, it takes on the secondary role. If the secondary node is not promoted, the primary MnT node resumes the primary role after it comes up again.



Caution When the primary node comes back up after a failover, obtain a backup of the secondary and restore the data to update the primary node.

Guidelines for Setting Up an Active Standby Pair of MnT Nodes

You can specify two MnT nodes on a Cisco ISE network, and configure them to be an active standby pair. We recommend that you back up the primary MnT node, and restore the data to the new secondary MnT node. This ensures that the history of the primary MnT node is synchronized with the new secondary node as the primary replicates new data. The following rules apply to an active standby pair:

- All changes are logged to the primary MnT node. The secondary node is read-only.
- Changes made to the primary node are automatically replicated on the secondary node
- Both the primary and secondary nodes are listed as log collectors, to which all other nodes send logs.
- The Cisco ISE dashboard is the main entry point for monitoring and troubleshooting. Monitoring information is displayed on the dashboard from the PAN . If the primary node goes down, monitoring information is available on the secondary node.
- Backing up and purging MnT data is not a part of a standard Cisco ISE node backup process. You must configure repositories for backup and data purging on both the primary and secondary MnT nodes, and use the same repositories for each.

MnT Node Failover Scenarios

The following scenarios apply to the active-standby or single node configurations corresponding to the MnT nodes:

- In an active-standby configuration of the MnT nodes, the primary PAN always points to the primary MnT node to collect the monitoring data. After the primary MnT node fails, the PAN points to the standby MnT node. The failover from the primary node to the secondary node takes place after it is down for more than five minutes.

However, after the primary node fails, the secondary node does not become the primary node. In case the primary node comes up, the PAN starts collecting the monitoring data again from the resumed primary node.

- If the primary MnT node is down, and you want to promote the standby MnT node to active status, you can do so by [Manually Modify the MnT Role](#) or by deregistering the existing primary MnT node. When you deregister the existing primary MnT node, the standby node becomes the primary MnT node, and the PAN automatically points to the newly promoted primary node.
- In an active-standby pair, if you deregister the secondary MnT node or if the secondary MnT node goes down, the existing primary MnT node remains the current primary node.
- If there is only one MnT node in the Cisco ISE deployment, then that node acts as the primary MnT node, and provides monitoring data to the PAN. However, when you register a new MnT node, and make it the primary node in the deployment, the existing primary MnT node automatically becomes the standby node. The PAN points to the newly registered primary MnT node to collect monitoring data.

Cisco pxGrid Node

You can use Cisco pxGrid to share the context-sensitive information from Cisco ISE session directory with other network systems such as Cisco ISE ecosystem partner systems and other Cisco platforms. The pxGrid framework can also be used to exchange policy and configuration data between nodes, such as sharing tags and policy objects between Cisco ISE and third-party vendors, and for other information exchanges. Cisco

pxGrid also allows third-party systems to invoke adaptive network control actions (EPS) to quarantine users or devices or both in response to a network or security event. The Cisco TrustSec information like tag definition, value, and description can be passed from Cisco ISE through the Cisco TrustSec topic to other networks. The endpoint profiles with Fully Qualified Names (FQNs) can be passed from Cisco ISE to other networks through an endpoint profile meta topic. Cisco pxGrid also supports bulk download of tags and endpoint profiles.

You can publish and subscribe to SXP bindings (IP-SGT mappings) through Cisco pxGrid. For more information about SXP bindings, see [Security Group Tag Exchange Protocol](#), on page 833.

In a high-availability configuration, Cisco pxGrid servers replicate information between the nodes through the PAN. When the PAN goes down, the Cisco pxGrid server stops handling the client registration and subscription. You need to manually promote the PAN for the Cisco pxGrid server to become active. You can check the **Cisco pxGrid services** window (**Administration > pxGrid Services**) to verify whether a Cisco pxGrid node is currently in active or standby state.

On the active Cisco node that has the pxGrid persona, these processes are displayed as **Running**. On the standby Cisco pxGrid node, they are displayed as **Standby**. If the active pxGrid node goes down, the standby pxGrid node detects this, and starts the four pxGrid processes. Within a few minutes, these processes show as **Running**, and the standby node becomes the active node. You can verify whether the Cisco pxGrid service is in standby on that node by running the CLI command **show logging application pxgrid/pxgrid.state**.

For Extensible Messaging and Presence Protocol clients, Cisco pxGrid nodes work in active-standby high availability mode which means that the Cisco pxGrid Service is in **Running** state on the active node and in **Disabled** state on the standby node.

After the automatic failover to the secondary Cisco pxGrid node is initiated, if the original primary Cisco pxGrid node is brought back into the network, the original primary Cisco pxGrid node continues to have the secondary role and is not promoted back to the primary role unless the current primary node goes down.



Note At times, the original primary Cisco pxGrid node might be automatically promoted back to the primary role.

In a high-availability deployment, when the primary Cisco pxGrid node goes down, it might take around three to five minutes to switchover to the secondary Cisco pxGrid node. We recommend that the client waits for the switchover to complete, before clearing the cache data just in case the primary Cisco pxGrid node fails.

The following logs are available for the Cisco pxGrid node:

- pxgrid.log: State change notifications.
- pxgrid-cm.log: Updates on publisher or subscriber or both and data exchange activity between the client and the server.
- pxgrid-controller.log: Displays the details of client capabilities, groups, and client authorization.
- pxgrid-jabberd.log: Displays all the logs related to system state and authentication.
- pxgrid-pubsub.log: Displays all the information related to publisher and subscriber events.



Note You can enable Cisco pxGrid with Base license, but you must have a Plus license to enable the Cisco pxGrid persona. In addition, certain extended Cisco pxGrid services may be available in your Base installation if you have recently installed an upgrade license for .



Note Cisco pxGrid should be defined in order to work with the Passive ID Work Center. For more information, see [PassiveID Work Center](#) , on page 361.

Cisco pxGrid Client and Capability Management

Clients connecting to Cisco ISE must register and receive account approval before using Cisco pxGrid services. Cisco pxGrid clients use the Cisco pxGrid client library available in the Cisco pxGrid SDK to become the clients. Cisco ISE supports both auto and manual approvals. A client can log in to Cisco pxGrid using a unique name and certificate-based mutual authentication. Similar to the AAA setting on a switch, clients can connect to either a configured Cisco pxGrid server hostname or an IP address.

Cisco pxGrid capabilities are information topics or channels on Cisco pxGrid for clients to publish and subscribe. In Cisco ISE, only capabilities such as Identity, Adaptive Network Control (ANC) , and Security Group Access (SGA) are supported. When a client creates a new capability, it appears in the **View by Capabilities** window. The navigation path for this window is **Administration > pxGrid Services > View by Capabilities**. You can enable or disable capabilities individually. Capability information is available from the publisher through publish, directed query, or bulk download query.



Note Users that are assigned to Endpoint Protection service (EPS) user group can perform actions in session group, because Cisco pxGrid session group is part of EPS group. If a user is assigned to EPS group, the user will be able to subscribe to the session group on the Cisco pxGrid client.

Related Topics

[Generate Cisco pxGrid Certificate](#), on page 67

Enable pxGrid Service

Before you begin

- Enable the pxGrid persona on at least one node to view the requests from the Cisco pxGrid clients.

-
- Step 1** Choose **Administration > pxGrid Services**.
- Step 2** Check the checkbox next to the client and click **Approve**.
- Step 3** Click **Refresh** to view the latest status.
- Step 4** Select the capability you want to enable and click **Enable**.
- Step 5** Click **Refresh** to view the latest status.
-

Enable pxGrid Capabilities

Before you begin

- Enable the pxGrid persona on at least one node to view the requests from the Cisco pxGrid clients.
- Enable a pxGrid client.

-
- Step 1** Choose **Administration** > **pxGrid Services**.
- Step 2** Click **View by Capabilities** at the top-right.
- Step 3** Select the capability you want to enable and click **Enable**.
- Step 4** Click **Refresh** to view the latest status.
-

Deploy Cisco pxGrid Node

You can enable Cisco pxGrid persona both on a standalone node and distributed deployment node.

Before you begin

- You can enable the pxGrid with Base license, but you must have a Plus license to enable pxGrid persona. In addition, certain extended pxGrid services may be available in your Base installation if you have recently installed an upgrade license .
- All nodes use the CA certificate for Cisco pxGrid service usage. If you used the default certificate for Cisco pxGrid service before upgrade, upgrade replaces that certificate with the internal CA certificate.
- You must have port 8910 open for Websockets (pxGrid 2.0), and port 5222 open for XMPP (pxGrid V1.0). If the Cisco pxGrid service is disabled on a node, port 5222 goes down, but port 8910 remains functional, and continues to respond to the requests.

-
- Step 1** Choose **Administration** > **System** > **Deployment**.
- Step 2** In the **Deployment Nodes** window, check the check box next to the node for which you want to enable the Cisco pxGrid services, and click **Edit**.
- Step 3** Click the **General Settings** tab and check the **pxGrid** check box.
- Step 4** Click **Save**.

When you upgrade from the previous version, the **Save** option might be disabled. This happens when the browser cache refers to the old files from the previous version of Cisco ISE. Clear the browser cache to enable the **Save** option.

Cisco pxGrid Live Logs

The Live Logs window displays all the pxGrid management events. Event info includes the client and capability names along with the event type and timestamp.

The navigation path for this window is **Administration > pxGrid Services > Live Log**. You can also clear the logs and resynchronize or refresh the list.

Configure Cisco pxGrid Settings

Before you begin

To perform the following task, you must be a Super Admin or System Admin.

Step 1 Choose **Administration > pxGrid Services > Settings**.

Step 2 Check one of the following check boxes based on your requirements:

- **Automatically approve new certificate-based accounts:** Check this check box to automatically approve the connection requests from new Cisco pxGrid clients.
- **Allow password-based account creation:** Check this check box to enable username or password-based authentication for Cisco pxGrid clients. When this option is enabled, Cisco pxGrid clients cannot be automatically approved.

Step 3 Click **Save**.

Use the **Test** option in the Cisco pxGrid **Settings** window to run a health check on the Cisco pxGrid node. View the details in the pxgrid or pxgrid-test.log file.

Generate Cisco pxGrid Certificate

Before you begin

- Some versions of Cisco ISE have a certificate for Cisco pxGrid that uses NetscapeCertType. We recommend that you generate a new certificate.
- To perform the following task, you must be a Super Admin or System Admin.
- A Cisco pxGrid certificate must be generated from the primary PAN.
- If the Cisco pxGrid certificate uses the subject alternative name (SAN) extension, be sure to include the FQDN of the subject identity as a DNS name entry.
- Create a certificate template with digital signature usage and use that to generate a new Cisco pxGrid certificate.

Step 1 Choose **Administration > pxGrid Services > Certificates**.

Step 2 Select one of the following options from the **I want to** drop-down list:

- **Generate a single certificate (without a certificate signing request):** You must enter the Common Name (CN) if you select this option.
- **Generate a single certificate (with a certificate signing request):** You must enter the Certificate Signing Request details if you select this option.

Step 3 **Common Name (CN):** (Required if you choose to **Generate a single certificate (without a certificate signing request)** option.) Enter the FQDN of the pxGrid client.

Step 4 **Certificate Signing Request Details:** (Required if you choose the **Generate a single certificate (without a certificate signing request)** option.) Enter the complete certificate-signing request details.

Step 5 **Description:** (Optional) Enter a description for this certificate.

Step 6 **Certificate Template:** Click the **pxGrid_Certificate_Template** link to download the certificate template edit the template based on your requirements.

Step 7 **Subject Alternative Name (SAN):** You can add multiple SANs. The following options are available:

- **IP address:** Enter the IP address of the Cisco pxGrid client to be associated with the certificate.
- **FQDN:** Enter the FQDN of the pxGrid client.

Step 8 Choose one of the following options from the **Certificate Download Format** drop-down list:


- **Certificate in Private Enhanced Electronic Mail (PEM) format, key in PKCS8 PEM format (including certificate chain):** The root certificate, the intermediate CA certificates, and the end entity certificate are represented in the PEM format. PEM-formatted certificates are BASE64-encoded ASCII files. Each certificate starts with the "-----BEGIN CERTIFICATE-----" tag and ends with the "-----END CERTIFICATE-----" tag. The end entity's private key is stored using PKCS* PEM. It starts with the "-----BEGIN ENCRYPTED PRIVATE KEY-----" tag and ends with the "-----END ENCRYPTED PRIVATE KEY-----" tag.
- **PKCS12 format (including certificate chain; one file for both the certificate chain and key):** A binary format to store the root CA certificate, the intermediate CA certificate, and the end entity's certificate and private key in one encrypted file.

Step 9 **Certificate Password:** Enter the password for the certificate and confirm the password by entering it again in the next field.

Step 10 Click **Create**.

The certificate that you created is visible in Cisco ISE in the **Issued Certificates** window.

Step 11 The navigation path for this window is **Administration > System > Certificates > Certificate Authority > Issued Certificates**

Step 12 To view this window, click the **Menu** icon () and choose **Administration > System > Certificates > Certificate Authority > Issued Certificates**

Note From Cisco ISE 2.4 patch 13 onwards, the certificate requirements have become stricter for the pxGrid service. If you are using the Cisco ISE default self-signed certificate as the pxGrid certificate, Cisco ISE might reject that certificate after applying Cisco ISE 2.4 patch 13 or later. This is because the older versions of that certificate have the **Netscape Cert Type** extension specified as **SSL Server**, which now fails (a client certificate is also required now).

Any client with a noncompliant certificate fails to integrate with Cisco ISE. Use a certificate issued by the internal CA or generate a new certificate with proper usage extensions:

- The **Key Usage** extension in the certificate must contain the **Digital Signature** and **Key Encipherment** fields.
- The **Extended Key Usage** extension in the certificate must contain the **Client Authentication** and **Server Authentication** fields.
- The **Netscape Certificate Type** extension is not required. If you like to include that extension, you must add both **SSL Client** and **SSL Server** in the extension.

- If you are using a self-signed certificate, the **Basic Constraints CA** field must be set to **True** and the **Key Usage** extension must contain the **Key Cert Sign** field.

. The certificate is also downloaded to your browser's downloads directory.

View Nodes in a Deployment

In the **Deployment Nodes** window, you can view all the Cisco ISE nodes, primary and secondary, that are part of your deployment.

-
- Step 1** Log in to the primary Cisco ISE Admin portal.
- Step 2** Choose **Administration > System > Deployment**.
- Step 3** Click **Deployment** from the navigation pane on the left.

All the Cisco ISE nodes that are part of your deployment are listed.

Synchronize Primary and Secondary Cisco ISE Nodes

You can make configuration changes to Cisco ISE only through the primary PAN. The configuration changes get replicated to all the secondary nodes. If, for some reason, this replication does not occur properly, you can manually synchronize the secondary PAN with the primary PAN.

-
- Step 1** Log in to the primary PAN.
- Step 2** Choose **Administration > System > Deployment**.
- Step 3** Check the check box next to the node that you want to synchronize with the primary PAN, and click **Syncup** to force a full database replication.
-

Change Node Personas and Services

You can edit the Cisco ISE node configuration to change the personas and services that run on the node.

Before you begin

- When you enable or disable any of the services that run on a PSN or make any changes to a PSN, you will be restarting the application server processes on which these services run. Expect a delay while these services restart.
- Due to this delay in restart of services, automatic failover if enabled in your deployment, might get initiated. To avoid this, make sure that the automatic failover configuration is turned off.

-
- Step 1** Log in to the primary PAN.
- Step 2** Choose **Administration > System > Deployment**.
- Step 3** Check the check box next to the node whose personas or services you want to change, and then click **Edit**.
- Step 4** Choose the personas and services that you want.
- Step 5** Click **Save**.
- Step 6** Verify receipt of an alarm on your primary PAN to confirm the persona or service change. If the persona or service change is not saved successfully, an alarm is not generated.
-

Effects of Modifying Nodes in Cisco ISE

When you make any of the following changes to a node in a Cisco ISE, that node restarts, which causes a delay:

- Register a node (Standalone to Secondary)
- Deregister a node (Secondary to Standalone)
- Change a primary node to Standalone (if no other nodes are registered with it; Primary to Standalone)
- Promote an Administration node (Secondary to Primary)
- Change the personas (when you assign or remove the Policy Service or Monitoring persona from a node)
- Modify the services in the Policy Service node (enable or disable the session and profiler services)
- Restore a backup on the primary and a sync up operation is triggered to replicate data from primary to secondary nodes



Note When you promote the secondary Administration node to the primary PAN position, the primary node will assume a secondary role. This causes both the primary and secondary nodes to restart, causing a delay.

Create a Policy Service Node Group

When two or more Policy Service nodes (PSNs) are connected to the same high-speed Local Area Network (LAN), we recommend that you place them in the same node group. This design optimizes the replication of endpoint profiling data by retaining less significant attributes that are local to the group and reducing the information that is replicated to the remote nodes in the network. Node group members also check on the availability of peer group members. If the group detects that a member has failed, it attempts to reset and recover all URL-redirected sessions on the failed node.

The node groups are used for the PSN failover in the sessions on which URL redirect (posture services, guest services and MDM) is imposed.



Note We recommend that you make all the PSNs in the same local network and part of the same node group. PSNs need not be part of a load-balanced cluster to join the same node group. However, each local PSN in a load-balanced cluster should typically be part of the same node group.

Before you can add PSNs as members to a node group, you must create the node group. You can create, edit, and delete PSN groups from the **Deployment** window of the Admin portal.

Before you begin

Node group members can communicate over TCP/7800.

Step 1 Choose **Administration** > **System** > **Deployment**.

Step 2 Click the **Settings** icon at the top of the left navigation pane.

Step 3 Click **Create Node Group**.

Step 4 Enter a unique name for your node group.

Note We do not recommend configuring a node group with the name **None**, as it may cause undesirable issues in node registration.

Step 5 (Optional) Enter a description for your node group.

Step 6 (Optional) Check the **Enable MAR Cache Distribution** check box and fill in the other options. Ensure that the MAR is enabled in the **Active Directory** window before enabling this option.

Step 7 Click **Submit** to save the node group.

After you save the node group, it should appear in the left navigation pane. If you do not see the node group in the left pane, it may be hidden. Click the **Expand** button on the navigation pane to view the hidden objects.

What to do next

Add a node to a node group, or edit a node by choosing the corresponding node group from the **Include node in node group** drop-down list in the **Policy Service** area.

Configure MnT Nodes for Automatic Failover

If you have two MnT nodes in a deployment, you can configure a primary-secondary pair for automatic failover to avoid downtime in the Cisco ISE Monitoring service. A primary-secondary pair ensures that a secondary MnT node automatically provides monitoring should the primary node fail.

Before you begin

- Before you can configure MnT nodes for automatic failover, they must be registered as Cisco ISE nodes.
- Configure monitoring roles and services on both nodes and name them for their primary and secondary roles, as appropriate.

- Configure repositories for backup and data purging on both the primary and secondary MnT nodes. For the backup and purging features to work properly, use the same repositories for both the nodes. Purging takes place on both the primary and secondary nodes of a redundant pair. For example, if the primary MnT node uses two repositories for backup and purging, you must specify the same repositories for the secondary node.

Configure a data repository for a MnT node using the **repository** command in the system CLI.



Caution For scheduled backup and purge to work properly on the nodes of a monitoring redundant pair, configure the same repository, or repositories, on both the primary and secondary nodes using the CLI. The repositories are not automatically synced between the two nodes.

From the Cisco ISE dashboard, verify that the MnT nodes are ready. The **System Summary** dashlet shows the MnT nodes with a green check mark to the left when their services are ready.

-
- Step 1** Choose **Administration > System > Deployment**.
- Step 2** In the **Deployment Nodes** window, check the check box next to the MnT node that you want to specify as primary, and click **Edit**.
- Step 3** Click the **General Settings** tab and choose **Primary** from the **Role** drop-down list.
- When you choose an MnT node as primary, the other MnT node automatically becomes secondary. In the case of a standalone deployment, primary and secondary role configuration is disabled.
- Step 4** Click **Save**. Both the primary and secondary nodes restart.
-

Remove a Node from Deployment

To remove a node from a deployment, you must deregister it. The deregistered node becomes a standalone Cisco ISE node.

It retains the last configuration that it received from the primary PAN and assumes the default personas of a standalone node, that is, Administration, Policy Service, and Monitoring. If you deregister an MnT node, this node will no longer be a syslog target.

When a Primary PSN is deregistered, the endpoint data is lost. If you want the PSN to retain the endpoint data after it becomes a standalone node, do one of the following:

- Obtain a backup from the primary PAN, and when the PSN becomes a standalone node, restore this data backup on it.
- Change the persona of the PSN to Administration (secondary PAN), synchronize the data in the **Deployment** window of the Admin portal, and then deregister the node. This node will now have all the data. You can then add a secondary PAN to the existing deployment.

You can view these changes in the **Deployment** window of the primary PAN. However, expect a delay of five minutes for the changes to take effect and appear in the **Deployment** window.

Before you begin

Before you remove a secondary node from a deployment, perform a backup of Cisco ISE configuration, which you can then restore later on, if needed.

-
- Step 1** Choose **Administration** > **System** > **Deployment**.
 - Step 2** Check the check box next to the secondary node that you want to remove, and then click **Deregister**.
 - Step 3** Click **OK**.
 - Step 4** Verify the receipt of an alarm on your primary PAN to confirm that the secondary node is deregistered successfully. If the secondary node fails to deregister from the primary PAN, the alarm is not generated.
-

Shut Down a Cisco ISE Node

Before you issue the **halt** command from the Cisco ISE CLI, we recommend that you stop the Cisco ISE application service and ensure that it is not performing a backup, restore, installation, upgrade, or remove operation. If you issue the **halt** command while the Cisco ISE is performing any of these operations, you will get one of the following warning messages:

```
WARNING: A backup or restore is currently in progress! Continue with halt?
```

```
WARNING: An install/upgrade/remove is currently in progress! Continue with halt?
```

If no processes are running when you use the **halt** command, or if you enter **Yes** in response to the warning message displayed, then you must respond to the following question:

```
Do you want to save the current configuration?
```

If you enter **Yes** to save the existing Cisco ISE configuration, the following message is displayed:

```
Saved the running configuration to startup successfully.
```



Note We recommend that you stop the application process before rebooting the appliance.

This is also applicable to reboot Cisco ISE. For more information, see the [Cisco Identity Services Engine CLI Reference Guide](#).

Change the Hostname or IP Address of a Standalone Cisco ISE Node

You can change the hostname, IP address, or domain name of standalone Cisco ISE nodes. However, you cannot use **localhost** as the hostname for a node.

Before you begin

If a Cisco ISE node is a part of a distributed deployment, you must first remove it from the deployment and ensure that it is a standalone node.

-
- Step 1** Change the hostname or IP address of the Cisco ISE node using the **hostname**, **ip address**, or **ip domain-name** command from the Cisco ISE CLI.
- Step 2** Reset the Cisco ISE application configuration using the **application stop ise** command from the Cisco ISE CLI to restart all the services.
- Step 3** Register the Cisco ISE node to the primary PAN if it is a part of a distributed deployment.

Note If you are using the hostname while registering the Cisco ISE node, the fully qualified domain name (FQDN) of the standalone node that you are going to register, for example, *abc.xyz.com* must be DNS-resolvable from the primary PAN. Otherwise, node registration fails. You must enter the IP addresses and FQDNs of the Cisco ISE nodes that are a part of your distributed deployment in the DNS server.

After you register the Cisco ISE node as a secondary node, the primary PAN replicates the change in the IP address, hostname, or domain name to the other Cisco ISE nodes in your deployment.

Replace the Cisco ISE Appliance Hardware

You should replace the Cisco ISE appliance hardware only if there is an issue with the hardware. For any software issues, you can reimage the appliance and reinstall the Cisco ISE software.

- Step 1** Re-image or re-install the Cisco ISE software on the new nodes.
- Step 2** Obtain a license with the UDI for the Primary and Secondary PANs and install it on the Primary PAN.
- Step 3** Restore the backup on the replaced Primary PAN.
The restore script will try to sync the data on the Secondary PAN, but the Secondary PAN is now a standalone node and the sync will fail. Data is set to the time the backup was taken on the Primary PAN.
- Step 4** Register the new node as a secondary server with the Primary PAN.
-



PART **III**

Setup Cisco ISE Management Access

- [Administer Cisco ISE, on page 77](#)
- [Manage Administrators and Admin Access Policies, on page 97](#)
- [Cisco ISE Licenses, on page 121](#)
- [Manage Certificates, on page 137](#)
- [Control Device Administration Using TACACS+, on page 199](#)
- [Manage Network Devices, on page 213](#)
- [Manage Resources, on page 263](#)
- [Logging Mechanism, on page 269](#)
- [Backup and Restore Operations, on page 277](#)
- [Setup Adaptive Network Control, on page 299](#)



CHAPTER 5

Administer Cisco ISE

- [Administrator Access Console, on page 77](#)
- [Configure Proxy Settings in Cisco ISE, on page 78](#)
- [Ports Used by the Administration Portal, on page 79](#)
- [Enable External RESTful Services Application Programming Interface, on page 79](#)
- [External RESTful Services Software Development Kit , on page 80](#)
- [Specify System Time and Network Time Protocol Server Settings, on page 80](#)
- [Change the System Time Zone, on page 81](#)
- [Configure SMTP Server to Support Notifications, on page 82](#)
- [Cisco ISE Deployment Upgrade, on page 82](#)
- [Cisco ISE Software Patches, on page 86](#)
- [Roll Back Software Patches, on page 88](#)
- [View Patch Install and Rollback Changes, on page 89](#)
- [Federal Information Processing Standards Mode Support, on page 89](#)
- [Secure SSH Key Exchange Using Diffie-Hellman Algorithm, on page 93](#)
- [Configure Cisco ISE to Send Secure Syslog, on page 93](#)
- [Default Secure Syslog Collector, on page 95](#)
- [Offline Maintenance, on page 96](#)

Administrator Access Console

The following steps describe how to log in to the administrative portal.

-
- Step 1** Enter the Cisco ISE URL in the address bar of your browser (for example, <https://<ise hostname or ip address>/admin/>).
 - Step 2** Enter the username and case-sensitive password that were specified and configured during the initial Cisco ISE setup.
 - Step 3** Click **Login** or press **Enter**.

If your login is unsuccessful, click the **Problem logging in?** link in the log in window and follow the instructions that are displayed.

Related Topics

[Administrator Login Browser Support, on page 78](#)

Administrator Login Browser Support

The Cisco ISE administration portal supports the following HTTPS-enabled browsers:

- Mozilla Firefox Version 61 and earlier versions
- Google Chrome Version 67 and earlier versions

[ISE Community Resource](#)

[ISE Pages Fail to Fully Load When Adblock Plus is Used](#)

Administrator Lockout Because of Login Attempts

If you enter an incorrect password for your specified administrator user ID enough times, the Cisco ISE administration portal locks you out of the system and adds a log entry in the Server Administrator Logins report. Cisco ISE suspends the credentials for that administrator ID until you reset the password that is associated with the administrator ID, as described in the Chapter “Performing Post-Installation Tasks” of the [Cisco Identity Services Engine Hardware Installation Guide](#). The number of failed attempts that is required to disable the administrator account is configurable according to the guidelines that are described in Section “User Account Custom Attributes and Password Policies”. After an administrator user account gets locked out, an email is sent to the associated user.

Only an administrator with the role of Super Admin (including Microsoft Active Directory users) can configure the disable administrator access option.

Configure Proxy Settings in Cisco ISE

If your existing network topology requires you to use a proxy server to enable Cisco ISE to access external resources (such as the remote download site where you can find client provisioning and posture-related resources), use the administration portal to configure the proxy settings.

The proxy settings impact the following Cisco ISE functions:

- Partner Mobile Management
- Endpoint Profiler Feed Service Update
- Endpoint Posture Update
- Endpoint Posture Agent Resources Download
- Certificate Revocation List (CRL) Download
- Guest Notifications

The Cisco ISE proxy configuration supports basic authentication for proxy servers. NT LAN Manager (NTLM) authentication is not supported.

Step 1 Choose **Administration > System > Settings > Proxy**.

Step 2 Enter the proxy IP address or DNS-resolvable hostname, and specify the port through which proxy traffic travels to and from Cisco ISE in the **Proxy host server : port** field.

- Step 3** Check the **Password required** check box, if necessary.
- Step 4** Enter the username and password that are used to authenticate to the proxy servers in the **User Name** and **Password** fields. Reenter the password in the **Confirm Password** field.
- Step 5** Enter the IP address or the address range of hosts or domains that must be bypassed in the **Bypass proxy for these hosts and domain** text box.
- Step 6** Click **Save**.
-

Ports Used by the Administration Portal

The administration portal uses HTTP port 80 and HTTPS port 443 and you cannot change these settings. You cannot configure any of the end user portals to use these ports, to reduce the risk to the administration portal.

Enable External RESTful Services Application Programming Interface

The External RESTful Services application programming interfaces (API) are based on HTTPS protocols and REST methodology and use port 9060.

The External RESTful Services APIs support basic authentication. The authentication credentials are encrypted and are part of the request header.

You can use any REST client like JAVA, cURL Linux command, Python, or any other client to invoke External RESTful Services API calls.



Note The ERS APIs support TLS 1.1 and TLS 1.2. ERS APIs do not support TLS 1.0 regardless of enabling TLS 1.0 in the **Security Settings** window (**Administration** > **System** > **Settings** > **Security Settings**). Enabling TLS 1.0 in the **Security Settings** window is related to the EAP protocol only and does not impact ERS APIs.

You must assign special privileges to a user to allow the user to perform operations using the External RESTful Services APIs. To perform operations using the External RESTful Services APIs (except for the Guest API), the user must be assigned to either **ERS Admin** or **ERS Operator** administrator group. The user must be authenticated against the credentials that are stored in the Cisco ISE internal database (internal admin users).

- **ERS Admin:** This user can create, read, update, and delete External RESTful Services API requests. They have full access to all External RESTful Services APIs (GET, POST, DELETE, PUT).
- **ERS Operator:** This user has read-only access (GET requests only).

The External RESTful Services APIs are disabled by default. If you evoke the External RESTful Services API calls before enabling them, you will receive an error response. Enable the Cisco ISE REST API feature for the applications developed for a Cisco ISE REST API to be able to access Cisco ISE. The Cisco REST APIs uses HTTPS port 9060, which is closed by default. If the Cisco ISE REST APIs are not enabled on the Cisco ISE administration server, the client application receives a timeout error from the server for any Guest REST API requests.

-
- Step 1** Choose **Administration > System > Settings > ERS Settings**.
- Step 2** Click the **Enable ERS for Read/Write** radio button to enable External RESTful Services on the Primary Administration node (PAN).
- Step 3** Click the **Enable ERS for Read for All Other Nodes** radio button if there are any secondary nodes in your deployment.
- External RESTful Service requests of all types are valid only for primary Cisco ISE nodes. Secondary nodes have read-access (GET requests).
- Step 4** Click **Save**.
-

All REST operations are audited and the logs are logged in the system logs. External RESTful Services APIs have a debug logging category, which you can enable from the debug logging window in the Cisco ISE GUI.

When you disable External RESTful Services in Cisco ISE, port 9060 remains open but no communication is allowed through the port.

Related Topics

[External RESTful Services Software Development Kit](#), on page 80

External RESTful Services Software Development Kit

Use the External RESTful Services (ERS) software development kit (SDK) to build your own tools. You can access the External RESTful Services SDK with the URL `https://<ISE-ADMIN-NODE>:9060/ers/sdk`. Only users with the role **ERS Admin** can access the External RESTful Services SDK.

The SDK consists of the following components:

- Quick reference API documentation.
- A complete list of all available API operations.
- Schema files available for download.
- Sample application in Java available for download.
- Use cases in cURL script format.
- Use cases in Python script format.
- Instructions on using Chrome Postman.

Specify System Time and Network Time Protocol Server Settings

Cisco ISE allows you to configure up to three NTP servers. Use the NTP servers to maintain accurate time and synchronize time across different timezones. You can also specify whether Cisco ISE must use only authenticated NTP servers and enter one or more authentication keys for that purpose.

We recommend that you set all the Cisco ISE nodes to the Coordinated Universal Time (UTC) timezone, especially if your Cisco ISE nodes are installed in a distributed deployment. This procedure ensures that the timestamps of the reports and logs from the various nodes in your deployment are always synchronized.

Before you begin

You must have either the Super Admin or System Admin administrator role assigned to you.

If you have both primary and secondary Cisco ISE nodes in your deployment, log in to the user interface of each node and configure the system time and Network Time Protocol (NTP) server settings.

-
- Step 1** Choose **Administration > System > Settings > System Time**.
- Step 2** In the **NTP Server Configuration** area, enter the unique IP addresses (IPv4 or IPv6 or fully qualified domain name [FQDN] value) for your NTP servers.
- Step 3** Check the **Only allow authenticated NTP servers** check box to restrict Cisco ISE to use only authenticated NTP servers to keep system and network time.
- Step 4** (Optional) To authenticate the NTP server using private keys, click the **NTP Authentication Keys** tab and specify one or more authentication keys if any of the servers that you specify require authentication through an authentication key. Carry out the following steps:
- Click **Add**.
 - Enter the necessary values in the **Key ID** and **Key Value** fields. Specify whether the key in question is trusted by checking or unchecking the **Trusted Key** check box, and click **OK**. The **Key ID** field supports numeric values between 1 to 65535 and the **Key Value** field supports up to 15 alphanumeric characters.
 - Click **OK**.
 - Return to the **NTP Server Configuration** tab.
- Step 5** Click **Save**.
-

Change the System Time Zone

Once set, you cannot edit the time zone from the administration portal. To change the time zone setting, enter the following command in the Cisco ISE CLI:

```
clock timezone timezone
```

For more information about the **clock timezone** command, see [Cisco Identity Services Engine CLI Reference Guide](#).



Note Cisco ISE uses Portable Operating System Interface (POSIX)-style signs in the time zone names and the output abbreviations. Therefore, zones west of Greenwich have a positive sign and zones east of Greenwich have a negative sign. For example, TZ='Etc/GMT+4' corresponds to 4 hours behind Universal Time (UT).



Caution When you change the time zone on a Cisco ISE appliance after installation, Cisco ISE services restart on that particular node. We recommend that you perform such changes within a maintenance window. Also, it is important to have all the nodes in a single Cisco ISE deployment that is configured to the same time zone. If you have Cisco ISE nodes located in different geographical locations or time zones, you should use a global time zone such as UTC on all the Cisco ISE nodes.

Configure SMTP Server to Support Notifications

Configure a Simple Mail Transfer Protocol (SMTP) server to send email notifications for alarms, to enable sponsors to send email notification to guests with their login credentials and password reset instructions, and to enable guests to automatically receive their login credentials after they successfully register themselves and with actions to take before their guest accounts expire.

Which ISE Nodes Send Email

The following list shows which node in a distributed ISE environment sends email.

Email Purpose	Node That Sends the Email
guest expiration	Primary PAN
alarms	Active MnT
sponsor and guest notifications from guest and sponsor portals	PSN
password expirations	Primary PAN

Step 1 Choose **Administration > System > Settings > SMTP Server**.

Step 2 Choose **Settings > SMTP Server**.

Step 3 Enter the hostname of the outbound SMTP server in the **SMTP server** field. This SMTP host server must be accessible from the Cisco ISE server. The maximum length for this field is 60 characters.

Step 4 Choose one of these options:

- Use **email address from Sponsor** to send guest notification email from the email address of the sponsor and choose **Enable Notifications**.
- Use the default email address to specify a specific email address from which to send all guest notifications and enter it in the **Default email address** field.

Step 5 Click **Save**.

The recipient of alarm notifications can be any internal admin users with the **Include system alarms in emails** option enabled. The sender's email address for sending alarm notifications is hardcoded as `ise@<hostname>`.

Cisco ISE Deployment Upgrade

Cisco ISE offers a GUI-based centralized upgrade from the administration portal. The progress of the upgrade and the status of the nodes are displayed in the Cisco ISE GUI. For information on the preupgrade and postupgrade tasks you must carry out, see the *Cisco Identity Services Engine Upgrade Guide* for the Cisco ISE release that you want to upgrade to.

The upgrade **Overview** window (**Administration > System > Upgrade > Overview**) lists all the nodes in your deployment, the personas that are enabled on them, the Cisco ISE version that is currently in use, and

the status (whether a node is active or inactive) of each node. You can begin upgrade only if all the nodes are in the **Active** state.

Different Types of Deployment

- **Standalone Node**—A single Cisco ISE node assuming the Administration, Policy Service, and Monitoring persona.
- **Multi-Node Deployment**—A distributed deployment with several ISE nodes. The procedure to upgrade a distributed deployment is discussed in the following listed references.

[ISE Community Resource](#)

For information on how to assess the network for ISE deployment readiness, see [ISE Deployment Assistant \(IDA\)](#).

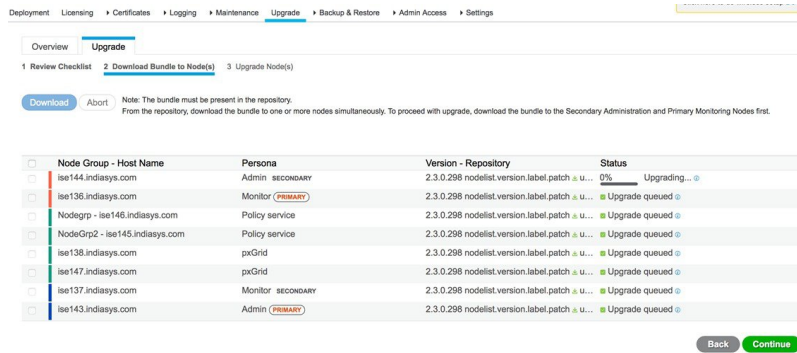
Upgrade a Distributed Deployment

Before you begin

Ensure that you have read the instructions in the section.

-
- Step 1** Click the **Upgrade** tab in the Admin portal.
- Step 2** Click **Proceed**.
- Step 3** Click **Proceed**.
- Step 4** The **Review Checklist** window is displayed. Read the given instructions carefully.
- Step 5** Check the **I have reviewed the checklist** check box, and click **Continue**.
The **Download Bundle to Nodes** window is displayed.
- Step 6** Download the upgrade bundle from the repository to the nodes:
- a) Check the check box next to the nodes to which you want to download the upgrade bundle.
 - b) Click **Download**.
The **Select Repository and Bundle** window is displayed.
 - c) Select the repository.
You can select the same repository or different repositories on different nodes, but you must select the same upgrade bundle on all the nodes.

Figure 5: Upgrade Window Showing the Repositories Selected for Each Node



- d) Check the check box next to the bundle that you want to use for the upgrade.
- e) Click **Confirm**.

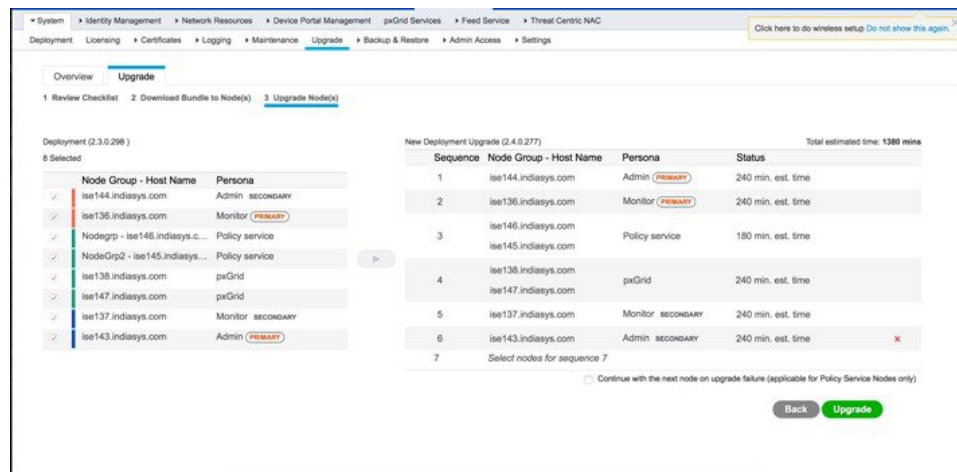
Once the bundle is downloaded to the node, the node status changes to **Ready for Upgrade**.

Step 7

Click **Continue**.

The **Upgrade Nodes** window appears.

Figure 6: Upgrade Window Showing the Current Deployment and the New Deployment



Step 8

Choose the upgrade sequence.

When you move a node to the new deployment, a time estimate for the upgrade is displayed on the **Upgrade Nodes** window. You can use this information to plan for upgrade and minimize downtime. Use the sequence given below if you have a pair of Administration and Monitoring Nodes, and several Policy Service Nodes.

- a) By default, the Secondary Administration Node is listed first in the upgrade sequence. After upgrade, this node becomes the Primary Administration Node in the new deployment.
- b) The Primary Monitoring Node is the next one in the sequence to be upgraded to the new deployment.
- c) Select the Policy Service Nodes and move them to the new deployment. You can alter the sequence in which the Policy Service Nodes are upgraded.

You can upgrade the Policy Service Nodes in sequence or in parallel. You can select a set of Policy Service Nodes and upgrade them in parallel.

- d) Select the Secondary Monitoring Node and move it to the new deployment.
- e) Finally, select the Primary Administration Node and move it to the new deployment.

Step 9

Check the **Continue with upgrade on failure** check box if you want to continue with the upgrade even if the upgrade fails on any of the Policy Service Nodes in the upgrade sequence.

This option is not applicable for the Secondary Administration Node and the Primary Monitoring Node. If any one of these nodes fail, the upgrade process is rolled back. If any of the Policy Service Nodes fail, the Secondary Monitoring Node and the Primary Administration Node are not upgraded and remain in the old deployment.

Step 10

Click **Upgrade** to begin the deployment upgrade.

Figure 7: Upgrade Window Showing the Upgrade Progress

The screenshot shows the 'Upgrade' window in the Cisco ISE management console. The breadcrumb navigation is: Deployment > Licensing > Certificates > Logging > Maintenance > Upgrade > Backup & Restore > Admin Access > Settings. The 'Upgrade' tab is active, and the 'Upgrade Node(s)' step is selected in the progress bar.

Deployment (2.3.0.298)
8 Selected

Node Group - Host Name	Persona
ise144.indiasys.com	Admin SECONDARY
ise136.indiasys.com	Monitor PRIMARY
Nodegrp - ise146.indiasys.c...	Policy service
NodeGrp2 - ise145.indiasys...	Policy service
ise138.indiasys.com	pxGrid
ise147.indiasys.com	pxGrid
ise137.indiasys.com	Monitor SECONDARY
ise143.indiasys.com	Admin PRIMARY

New Deployment Upgrade (2.4.0.277) Total estimated time: 1140 mins

Sequence	Node Group - Host Name	Persona	Status
1	ise144.indiasys.com	Admin PRIMARY	Upgrade
2	ise136.indiasys.com	Monitor PRIMARY	5% Upgrading...
3	ise146.indiasys.com	Policy service	Upgrade queued
	ise145.indiasys.com	Policy service	Upgrade queued
4	ise138.indiasys.com	pxGrid	Upgrade queued
	ise147.indiasys.com	pxGrid	Upgrade queued
5	ise137.indiasys.com	Monitor SECONDARY	Upgrade queued
6	ise143.indiasys.com	Admin SECONDARY	Upgrade queued
7	Select nodes for sequence 7		

Continue with the next node on upgrade failure (applicable for Policy Service Nodes only)

Back Upgrade

The upgrade progress is displayed for each node. On successful completion, the node status changes to **Upgrade Complete**.

Note When you upgrade a node from the Admin portal, if the status does not change for a long time (and remains at 80%), you can check the upgrade logs from the CLI or the status of the upgrade from the console. Log in to the CLI or view the console of the Cisco ISE node to view the progress of upgrade. You can use the **show logging application** command to view the *upgrade-uibackend-cliconsole.log* and *upgrade-postosupgrade-yyyymmdd-xxxxxx.log*.

You can view the following upgrade logs from the CLI using the show logging application command:

- DB Data Upgrade Log
- DB Schema Log
- Post OS Upgrade Log

In case you get a warning message: **The node has been reverted back to its pre-upgrade state**, go to the **Upgrade** window, click the **Details** link. Address the issues that are listed in the **Upgrade Failure Details** window. After you fix all the issues, click **Upgrade** to reinitiate the upgrade.

Note If the posture data update process is running on the Primary Administration Node in the new deployment, you cannot register a node to the Primary Administration Node. You can either wait till the posture update process is over (which might take approximately 20 minutes) or disable the posture auto-update feature from the **Updates** window while upgrading or registering a node to the new deployment. The navigation path for this window is **Administration > System > Settings > Posture > Updates**.

Cisco ISE Software Patches

Cisco ISE software patches are always cumulative. Cisco ISE allows you to perform patch installation and rollback from CLI or GUI.

You can install patches on Cisco ISE servers in your deployment from the Primary PAN. To install a patch from the Primary PAN, you must download the patch from Cisco.com to the system that runs your client browser.

If you are installing the patch from the GUI, the patch is automatically installed on the Primary PAN first. The system then installs the patch on the other nodes in the deployment in the order listed in the GUI. You cannot control the order in which the nodes are updated. You can also manually install, roll back, and view patch version. To do this, choose **Administrator > System > Maintenance > Patch management** window in the GUI.

If you are installing the patch from the CLI, you can control the order in which the nodes are updated. However, we recommend that you install the patch on the Primary PAN first.

If you want to validate the patch on some of the nodes before upgrading the entire deployment, you can use the CLI to install the patch on selected nodes. Use the following CLI command to install the patch:

```
patch install <patch_bundle> <repository_that_stores_patch_file>
```

For more information, see the "install Patch" section in the "Cisco ISE CLI Commands in EXEC Mode" chapter in [Cisco Identity Services Engine CLI Reference Guide](#).

You can install the required patch version directly. For example, if you are currently using Cisco ISE 2.x and would like to install Cisco ISE 2.x patch 5, you can directly install Cisco ISE 2.x patch 5, without installing the previous patches (in this example, Cisco ISE 2.x patches 1 – 4). To view the patch version in the CLI, use the following CLI command:

```
show version
```

Related Topics

[Software Patch Installation Guidelines](#), on page 87

[Install a Software Patch](#), on page 87

[Software Patch Installation Guidelines](#), on page 87

[Software Patch Rollback Guidelines](#), on page 88

[Install a Software Patch](#), on page 87

[Roll Back Software Patches](#), on page 88

Software Patch Installation Guidelines

When you install a patch on an ISE node, the node is rebooted after the installation is complete. You might have to wait for a few minutes before you can log in again. You can schedule patch installations during a maintenance window to avoid temporary outage.

Ensure that you install patches that are applicable for the Cisco ISE version that is deployed in your network. Cisco ISE reports any mismatch in versions as well as any errors in the patch file.

You cannot install a patch with a version that is lower than the patch that is currently installed on Cisco ISE. Similarly, you cannot roll back changes of a lower-version patch if a higher version is currently installed on Cisco ISE. For example, if patch 3 is installed on your Cisco ISE servers, you cannot install or roll back patch 1 or 2.

When you install a patch from the Primary PAN that is part of a distributed deployment, Cisco ISE installs the patch on the primary node and then all the secondary nodes in the deployment. If the patch installation is successful on the Primary PAN, Cisco ISE then continues patch installation on the secondary nodes. If it fails on the Primary PAN, the installation does not proceed to the secondary nodes. However, if the installation fails on any of the secondary nodes for any reason, it still continues with the next secondary node in your deployment.

When you install a patch from the Primary PAN that is part of a two-node deployment, Cisco installs the patch on the primary node and then on the secondary node. If the patch installation is successful on the Primary PAN, Cisco then continues patch installation on the secondary node. If it fails on the Primary PAN, the installation does not proceed to the secondary node.

Install a Software Patch

Before you begin

- You must have the Super Admin or System Admin administrator role assigned.
- Go to **Administration > System > Deployment > PAN Failover**, and ensure that the **Enable PAN Auto Failover** check box is unchecked. The PAN auto-failover configuration must be disabled for the duration of this task.

Step 1 Choose **Administration > System > Maintenance > Patch Management > Install**.

Step 2 Click **Browse** and choose the patch that you downloaded from Cisco.com.

Step 3 Click **Install** to install the patch.

After the patch is installed on the PAN, Cisco ISE logs you out and you have to wait for a few minutes before you can log in again.

Note When patch installation is in progress, **Show Node Status** is the only function that is accessible on the Patch Management page.

Step 4 Choose **Administration > System > Maintenance > Patch Management** to return to the Patch Installation page.

Step 5 Click the radio button next to the patch that you have installed on any secondary node and click **Show Node Status** to verify whether installation is complete.

What to do next

If you need to install the patch on one or more secondary nodes, ensure that the nodes are up and repeat the process to install the patch on the remaining nodes.

Roll Back Software Patches

When you roll back a patch from the PAN that is part of a deployment with multiple nodes, Cisco ISE rolls back the patch on the primary node and then all the secondary nodes in the deployment.

Before you begin

- You must have either the Super Admin or System Admin administrator role assigned.

Step 1 Choose **Administration > System > Maintenance > Patch Management**.

Step 2 Click the radio button for the patch version whose changes you want to roll back and click **Rollback**.

Note When a patch rollback is in progress, **Show Node Status** is the only function that is accessible on the Patch Management page.

After the patch is rolled back from the PAN, Cisco ISE logs you out and you have to wait a few minutes before you can log in again.

Step 3 After you log in, click the **Alarms** link at the bottom of the page to view the status of the rollback operation.

Step 4 To view the progress of the patch rollback, choose the patch in the Patch Management page and click **Show Node Status**.

Step 5 Click the radio button for the patch and click **Show Node Status** on a secondary node to ensure that the patch is rolled back from all the nodes in your deployment.

If the patch is not rolled back from any of the secondary nodes, ensure that the node is up and repeat the process to roll back the changes from the remaining nodes. Cisco ISE only rolls back the patch from the nodes that still have this version of the patch installed.

Related Topics

[Software Patch Rollback Guidelines](#), on page 88

Software Patch Rollback Guidelines

To roll back a patch from Cisco ISE nodes in a deployment, you must first roll back the change from the PAN. If this is successful, the patch is then rolled back from the secondary nodes. If the rollback process fails on the PAN, the patches are not rolled back from the secondary nodes. However, if the patch rollback fails on any secondary node, it still continues to roll back the patch from the next secondary node in your deployment.

While Cisco ISE rolls back the patch from the secondary nodes, you can continue to perform other tasks from the PAN GUI. The secondary nodes will be restarted after the rollback.

View Patch Install and Rollback Changes

To view reports related to installed patches, perform the following steps.

Before you begin

You must have either the Super Admin or System Admin administrator role assigned. You can install or rollback patches choose **Administration > System > Maintenance > Patch Management** page. You can also view the status (installed/in-progress/not installed) of a particular patch on each node in the deployment, by selecting a specific patch and clicking the **Show Node Status** button.

-
- Step 1** Choose **Operations > Reports > Audit > Operations Audit**. By default, records for the last seven days are displayed.
- Step 2** Click the **Filter** drop-down, and choose **Quick Filter** or **Advanced Filter** and use the required keyword, for example, patch install initiated, to generate a report containing the installed patches.
-

Federal Information Processing Standards Mode Support

Cisco ISE uses embedded Federal Information Processing Standards (FIPS) 140-2 validated cryptographic modules Cisco Common Cryptographic Module (Certificate #1643 and Certificate #2100). For details of the FIPS compliance claims, see [FIPS Compliance Letter](#).

When the FIPS mode is enabled, the Cisco ISE administrator interface displays a FIPS mode icon at the left of the node name in the top-right corner of the window.

If Cisco ISE detects the use of a protocol or certificate that is not supported by the FIPS 140-2 standard, it displays a warning with the name of the protocol or certificate that is noncompliant, and the FIPS mode is not enabled. Ensure that you choose only FIPS-compliant protocols and replace non-FIPS compliant certificates before you enable the FIPS mode.

The FIPS standard places limitations on the use of certain algorithms. Cisco ISE enables FIPS 140-2 compliance via RADIUS shared secret and key management measures. When the FIPS mode is enabled, any function that uses non-FIPS-compliant algorithms fail.

The certificates that are installed in Cisco ISE must be re-issued if the cryptographic algorithms or their parameters that are used in the certificates are not supported by FIPS.

When you enable the FIPS mode, the following functions are affected:

- IEEE 802.1X environment
 - EAP-Flexible Authentication via Secure Tunneling (EAP-FAST)
 - EAP-Transport Layer Security (EAP-TLS)
 - PEAP
 - RADIUS
- Secure Shell (SSH) clients can only use SSHv2
- Lightweight Directory Access Protocol (LDAP) over SSL

Cisco ISE enables FIPS 140-2 compliance via RADIUS shared secret and key management measures. When the FIPS mode is enabled, any function that uses a non-FIPS-compliant algorithm fails.

Once the FIPS Mode is enabled, all the nodes in the deployment are rebooted automatically. Cisco ISE performs a rolling restart by first restarting the primary PAN and then restarting each secondary node, one at a time. Hence, it is recommended that you plan for the downtime before changing the configuration.



Tip We recommend that you do not enable FIPS mode before completing the database migration process.

Enable Federal Information Processing Standards Mode in Cisco ISE

To enable the FIPS mode in Cisco ISE:

-
- Step 1** Choose **Administration > System > Settings > FIPS Mode**.
 - Step 2** Choose **Enabled** from the **FIPS Mode** drop-down list.
 - Step 3** Click **Save** and restart your machine.
-

What to do next

After you enable FIPS mode, enable and configure the following FIPS 140 compliant functions:

- [Generate a Self-Signed Certificate, on page 148.](#)
- [Create a Certificate-Signing Request and Submit it to a Certificate Authority, on page 158.](#)
- Configure RADIUS authentication settings as mentioned under [Network Device Definition Settings, on page 1022.](#)

You may want to enable administrator account authorization using a Common Access Card function. Although using Common Access Card functions for authorization is not strictly a FIPS 140 requirement, it is a well-known secure-access measure that is used in several environments to bolster FIPS 140 compliance.

Configure Cisco ISE for Administrator Common Access Card Authentication

Before you begin

- (Optional) Enable the FIPS mode in Cisco ISE. FIPS mode is not required for certificate-based authentication, but the two security measures often go hand-in-hand. If you plan to deploy Cisco ISE in a FIPS 140 compliant deployment and use Common Access Card certificate-based authorization, enable the FIPS mode and specify the appropriate private keys and encryption/decryption settings first.
- Ensure that the domain name server (DNS) in Cisco ISE is set for Active Directory.
- Ensure that Active Directory user and user group memberships have been defined for each administrator certificate.

To ensure that Cisco ISE can authenticate and authorize an administrator based on the Common Access Card-based client certificate that is submitted from the browser, configure the following:

- The external identity source (Active Directory in the following example).
- The Active Directory user groups to which the administrator belongs.
- How to find the user's identity in the certificate.
- Active Directory user groups to Cisco ISE RBAC permissions mapping.
- The Certificate Authority (trust) certificates that sign the client certificates.
- A method to determine if a client certificate has been revoked by the certificate authority.

You can use a Common Access Card to authenticate credentials when logging in to Cisco ISE.

Step 1 When you enable FIPS mode, you are prompted to restart your system. You can defer the restart if you are going to import certificate authority certificates as well.

Step 2 Configure an Active Directory identity source in Cisco ISE and join all Cisco ISE nodes to Active Directory.

Step 3 Configure a certificate authentication profile according to the guidelines.

Be sure to select the attribute in the certificate that contains the administrator username in the **Principal Name X.509 Attribute** field. For Common Access Cards, the Signature Certificate on the card is normally used to look up the user in Active Directory. The Principal Name is found in this certificate in the **Subject Alternative Name** extension, specifically in the **Other Name** area of the extension. So the attribute selection here should be **Subject Alternative Name - Other Name**.

If the Active Directory record for the user contains the user's certificate, and you want to compare the certificate that is received from the browser against the certificate in Active Directory, check the **Binary Certificate Comparison** check box, and select the Active Directory instance name that was specified earlier.

Step 4 Enable Active Directory for password-based administrator authentication. Choose the Active Directory instance name that you connected and joined to Cisco ISE earlier.

Note You must use password-based authentication until you complete other configurations. Then, you can change the authentication type to client certificate based at the end of this procedure.

Step 5 Create an external administrator group and map it to an Active Directory group. Choose **Administration > System > Admin Access > Administrators > Admin Groups**. Create an external system administrator group.

Step 6 Configure an administrator authorization policy to assign RBAC permissions to the external administrator groups.

Caution We strongly recommend that you create an external Super Admin group, map it to an Active Directory group, and configure an administrator authorization policy with Super Admin permissions (menu access and data access), and create at least one user in that Active Directory Group. This mapping ensures that at least one external administrator has Super Admin permissions once **Client Certificate-Based Authentication** is enabled. Failure to do this may lead to situations where the Cisco ISE administrator is locked out of critical functionality in the administration portal.

Step 7 Choose **Administration > System > Certificates > Certificate Store** to import certificate authority certificates into the Cisco ISE trusted certificates store.

Cisco ISE does not accept a client certificate unless the certificate authority certificates in the client certificate's trust chain are placed in the Cisco ISE Certificates store. You must import the appropriate certificate authority certificates in the Cisco ISE Certificates store.

- a) Click **Browse** to choose the certificate.

- b) Check the **Trust for client authentication** check box.
- c) Click **Submit**.

Cisco ISE prompts you to restart all the nodes in the deployment after you import a certificate. You can defer the restart until you import all the certificates. However, after importing all the certificates, you must restart Cisco ISE before you proceed.

Step 8 Configure the certificate authority certificates for revocation status verification.

- a) Choose **Administration > System > Certificates > OSCP Services**.
- b) Click **Add**.
- c) Enter the name of an OSCP server, an optional description, and the URL of the server in the corresponding fields.
- d) Choose **Administration > System > Certificates > Certificate Store**.
- e) For each certificate authority certificate that can sign a client certificate, specify how to do the revocation status check for that certificate authority. Choose a certificate authority certificate from the list and click Edit. On the edit page, choose OCSP or certificate revocation list (CRL) validation, or both. If you choose OCSP, choose an OCSP service to use for that certificate authority. If you choose CRL, specify the CRL Distribution URL and other configuration parameters.

Step 9 Enable client certificate-based authentication. Choose **Administration > System > Admin Access > Authentication**.

- a) In the **Authentication Method** tab, click the **Client Certificate Based** radio button.
- b) Choose the certificate authentication profile that you configured earlier from the **Certificate Authentication Profile** drop-down list.
- c) Select the Active Directory instance name from the **Identity Source** drop-down list.
- d) Click **Save**.

Here, you switch from password-based authentication to client certificate-based authentication. The certificate authentication profile that you configured earlier determines how the administrator's certificate is authenticated. The administrator is authorized using the external identity source, which in this example is Active Directory.

The Principal Name attribute from the certificate authentication profile is used to look up the administrator in Active Directory.

Related Topics

[Supported Common Access Card Standards](#), on page 92

[Common Access Card Operation in Cisco ISE](#), on page 92

Supported Common Access Card Standards

Cisco ISE supports U.S. government users who authenticate themselves using Common Access Card authentication devices. A Common Access Card is an identification badge with an electronic chip containing a set of X.509 client certificates that identify a particular employee. Access via the Common Access Card requires a card reader into which you insert the card and enter a PIN. The certificates from the card are then transferred into the Windows certificate store, where they are available to applications such as the local browser running Cisco ISE.

Common Access Card Operation in Cisco ISE

You can configure the administration portal so that Cisco ISE authentications occur only through a client certificate. Credentials-based authentication that requires user IDs or passwords is not permitted. In client certificate-based authentication, you insert a Common Access Card card, enter a PIN, and then enter the Cisco ISE administration portal URL into the browser address field. The browser forwards the certificate to Cisco

ISE, and Cisco ISE authenticates and authorizes your login session, based on the contents of the certificate. If this process is successful, the Cisco ISE Monitoring and Troubleshooting home page is displayed and you are given the appropriate RBAC permissions.

Cisco NAC Agent Requirements When FIPS Mode Is Enabled

The Cisco NAC Agent always looks for the Microsoft Internet Explorer TLS 1.0 settings to discover the Cisco ISE network. These TLS 1.0 settings are enabled in Internet Explorer. Client machines must have Windows Internet Explorer Version 7, 8, or 9 installed, and TLS1.0 must be enabled for Cisco ISE posture assessment functions to operate on client machines accessing the network. The Cisco NAC Agent can automatically enable the TLS 1.0 setting in Windows Internet Explorer if the FIPS mode is enabled in Cisco ISE.

Secure SSH Key Exchange Using Diffie-Hellman Algorithm

Configure Cisco ISE to only allow Diffie-Hellman-Group14-SHA1 Secure Shell (SSH) key exchanges. Enter the following commands from the Cisco ISE CLI Configuration Mode:

```
service sshd key-exchange-algorithm diffie-hellman-group14-sha1
```

Here is an example:

```
ise/admin#conf t
```

```
ise/admin (config)#service sshd key-exchange-algorithm diffie-hellman-group14-sha1
```

Configure Cisco ISE to Send Secure Syslog

Before you begin

To configure Cisco ISE to send only TLS-protected secure syslog between the Cisco ISE nodes and to the monitoring nodes, perform the following tasks:

- Ensure that all the Cisco ISE nodes in your deployment are configured with appropriate server certificates. For your setup to be FIPS 140 compliant, the certificate keys must have a key size of 2048 bits or greater.
- Enable the FIPS mode in the administration portal.
- Ensure that the default network access authentication policy does not allow any version of the SSL protocol. Use the TLS protocol in the FIPS mode along with FIPS-approved algorithms.
- Ensure that all the nodes in your deployment are registered with the primary PAN. Also ensure that at least one node in your deployment has the Monitoring persona enabled on it to function as the secure syslog receiver (TLS server).
- Check the supported RFC standards for syslogs. See [Cisco Identity Services Engine Network Component Compatibility](#) guide for your Cisco ISE release.

Step 1 Configure a secure syslog remote logging target.

Step 2 Enable logging categories to send auditable events to the secure syslog remote logging target.

Step 3 Disable TCP Syslog and UDP syslog collectors. Only TLS-protected syslog collectors must be enabled.

Related Topics

[Configure Secure Syslog Remote Logging Target](#), on page 94

[Enable Logging Categories to Send Auditable Events to the Secure Syslog Target](#), on page 94

[Disable TCP Syslog and UDP Syslog Collectors](#), on page 95

Configure Secure Syslog Remote Logging Target

Cisco ISE system logs are collected and stored by log collectors for various purposes. To configure a secure syslog target, choose a Cisco ISE node with the Monitoring persona enabled on it as your log collector.

-
- Step 1** Log in to the Cisco ISE administration portal.
- Step 2** Choose **Administration > System > Logging > Remote Logging Targets**.
- Step 3** Click **Add**.
- Step 4** Enter a name for the secure syslog server.
- Step 5** Choose **Secure Syslog** from the **Target Type** drop-down list.
- Step 6** Choose **Enabled** from the **Status** drop-down list.
- Step 7** Enter the hostname or IP address of the Cisco ISE monitoring node in your deployment, in the **Host / IP Address** field.
- Step 8** Enter *6514* as the port number in the **Port** field. The secure syslog receiver listens on TCP port 6514.
- Step 9** Choose the syslog facility code from the **Facility Code** drop-down list. The default value is **LOCAL6**.
- Step 10** Check the following check boxes to enable the corresponding configurations:
- Include Alarms For This Target**
 - Comply to RFC 3164**
 - Enable Server Identity Check**
- Step 11** Check the **Buffer Messages When Server Down** check box. If this option is checked, Cisco ISE stores the logs if the secure syslog receiver is unreachable, periodically checks the secure syslog receiver, and forwards the logs when the secure syslog receiver comes up.
- Enter the buffer size in the **Buffer Size (MB)** field.
 - For Cisco ISE to periodically check the secure syslog receiver, enter the reconnect timeout value in the **Reconnect Time (Sec)** field. The timeout value is configured in seconds.
- Step 12** Choose the CA certificate that Cisco ISE must present to the secure syslog server from the **Select CA Certificate** drop-down list.
- Step 13** Ensure that the **Ignore Server Certificate validation** check box is not checked when configuring a Secure Syslog.
- Step 14** Click **Submit**.
-

Enable Logging Categories to Send Auditable Events to the Secure Syslog Target

Enable logging categories for Cisco ISE to send auditable events to the secure syslog target.

-
- Step 1** Choose **Administration > System > Logging > Logging Categories**.
- Step 2** Click the radio button next to the **Administrative and Operational Audit** logging category, then click **Edit**.
- Step 3** Choose **WARN** from the **Log Severity Level** drop-down list.
- Step 4** In the **Targets** area, move the secure syslog remote logging target that you created earlier to the **Selected** area.
- Step 5** Click **Save**.
- Step 6** Repeat this task to enable the following logging categories. Both these logging categories have **INFO** as the default log severity level and you cannot edit it.
- **AAA Audit**.
 - **Posture and Client Provisioning Audit**.
-

Disable TCP Syslog and UDP Syslog Collectors

For Cisco ISE to send only secure syslog between the nodes, you must disable the TCP and UDP syslog collectors, and enable only Secure Syslog collectors.

- Step 1** Choose **Administration > System > Logging > Remote Logging Targets**.
- Step 2** Click the radio button next to a TCP or UDP syslog collector.
- Step 3** Click **Edit**.
- Step 4** Choose **Disabled** from the **Status** drop-down list.
- Step 5** Click **Save**.
- Step 6** Repeat this process until you disable all the TCP or UDP syslog collectors.
-

Default Secure Syslog Collector

Cisco ISE provides default secure syslog collectors for the MnT nodes. By default, no logging categories are mapped to these default secure syslog collectors. The default secure syslog collectors are named as follows:

- Primary MnT node: SecureSyslogCollector
- Secondary MnT node: SecureSyslogCollector2

You can view this information on the **Remote Logging Targets** window (click the **Menu** icon (☰) and choose **Administration > System > Logging > Remote Logging Targets**). You cannot delete the default syslog collectors and cannot update the following fields for the default syslog collectors:

- **Name**
- **Target Type**
- **IP/Host address**

- **Port**

During a fresh Cisco ISE installation, a certificate that is named **Default Self-signed Server Certificate** is added to the Trusted Certificates store. This certificate is marked for **Trust for Client authentication and Syslog** usage, making it available for secure syslog usage. While configuring your deployment or updating the certificates, you must assign relevant certificates to the secure syslog targets.

During a Cisco ISE upgrade, if there are any existing secure syslog targets pointing to MnT nodes on port 6514, the names and configurations of the target are retained. After the upgrade, you cannot delete these syslog targets and you cannot edit the following fields:

- **Name**
- **Target Type**
- **IP/Host address**
- **Port**

If no such targets exist at the time of upgrade, default secure syslog targets are created similar to the fresh installation scenario, without any certificate mapping. You can assign the relevant certificates to these syslog targets. If you try to map a secure syslog target that is not mapped to any certificate to a logging category, Cisco ISE displays the following message:

```
Please configure the certificate for log_target_name
```

Offline Maintenance

If the maintenance time period is less than an hour, take the Cisco ISE node offline and perform the maintenance task. When you bring the node back online, the PAN node will automatically synchronize all the changes that happened during maintenance time period. If the changes are not synchronized automatically, you can manually synchronize it with the PAN.

If the maintenance time period is more than an hour, deregister the node at the time of maintenance and reregister the node when you add the node back to deployment.

We recommend that you schedule the maintenance at a time period during which the activity is low.



-
- Note**
1. Data replication issues may occur if the queue contains more than 1,000,000 messages or if the Cisco ISE node is offline for more than six hours.
 2. If you are performing maintenance on the primary MnT node, we recommend that you take an operational backup of the MnT node before performing maintenance activities.
-



CHAPTER 6

Manage Administrators and Admin Access Policies

- [Cisco ISE Administrators, on page 97](#)
- [Cisco ISE Administrator Groups, on page 99](#)
- [Administrative Access to Cisco ISE, on page 107](#)

Cisco ISE Administrators

Administrators can use the admin portal to:

- Manage deployments, help desk operations, network devices, and node monitoring and troubleshooting.
- Manage Cisco ISE services, policies, administrator accounts, and system configuration and operations.
- Change administrator and user passwords.

A CLI administrator can start and stop the Cisco ISE application, apply software patches and upgrades, reload or shut down the Cisco ISE appliance, and view all the system and application logs. Because of the special privileges that are granted to a CLI administrator, we recommend that you protect the CLI administrator credentials and create web-based administrators for configuring and managing Cisco ISE deployments.

The username and password that you configure during setup is intended only for administrative access to the CLI. This role is considered to be the CLI admin user, also known as CLI administrator. By default, the username for a CLI admin user is admin, and the password is defined during setup. There is no default password. This CLI admin user is the default admin user, and this user account cannot be deleted. However, other administrators can edit it, including options to enable, disable, or change password for the corresponding account.

You can either create an administrator, or you can promote an existing user to an administrator role. Administrators can also be demoted to simple network user status by disabling the corresponding administrative privileges.

Administrators are users who have local privileges to configure and operate the Cisco ISE system.

Administrators are assigned to one or more admin groups.



Note Starting with Cisco ISE Release 2.7, use alphanumeric values while creating user accounts in Cisco ISE.

Related Topics

[Cisco ISE Administrator Groups](#), on page 99

Privileges of a CLI Administrator Versus a Web-Based Administrator

A CLI administrator can start and stop the Cisco ISE application, apply software patches and upgrades, reload or shut down the Cisco ISE appliance, and view all the system and application logs. Because of the special privileges granted to a CLI administrator, we recommend that you protect the CLI administrator credentials and create web-based administrators for configuring and managing Cisco ISE deployments.

Create a New Administrator

Cisco ISE administrators need accounts with specific roles assigned to them in order to perform specific administrative tasks. You can create multiple administrator accounts and assign one or more roles to these admins based on the administrative tasks that these admins have to perform.

Use the **Admin Users** window to view, create, modify, delete, change the status, duplicate, or search for attributes of Cisco ISE administrators.

Step 1 Choose **Administration > System > Admin Access > Administrators > Admin Users > Add**.

Step 2 From the **Add** drop-down, choose one of the following options:

- **Create an Admin User**

If you choose **Create an Admin User**, a **New Administrator** window appears, from where you can configure account information for the new admin user.

- **Select from Network Access Users**

If you choose **Select from Network Access Users**, a list of current users appears, from which you can choose a user. Subsequently, the **Admin User** window corresponding to this user appears.

Step 3 Enter values in the fields. The characters supported for the **Name** field are # \$ ' () * + - . / @ _.

The admin user name must be unique. If you have entered an existing user name, an error pop-up window displays the following message:

```
User can't be created. A User with that name already exists.
```

Step 4 Click **Submit** to create a new administrator in the Cisco ISE internal database.

Related Topics

[Read-Only Admin Policy](#)

[Create an Internal Read-Only Admin](#)

[Customize Menu Access for the Read-Only Administrator](#)

[Map External Groups to the Read-Only Admin Group](#)

Cisco ISE Administrator Groups

Administrator groups are role-based access control (RBAC) groups in Cisco ISE. All the administrators who belong to the same group share a common identity and have the same privileges. An administrator's identity as a member of a specific administrative group can be used as a condition in authorization policies. An administrator can belong to more than one administrator group.

An administrator account with any level of access can be used to modify or delete objects for which it has permission, on any window it has access to.

The Cisco ISE security model limits administrators to creating administrative groups that contain the same set of privileges that the administrator has. The privileges given are based on the administrative role of the user, as defined in the Cisco ISE database. Thus, administrative groups form the basis for defining privileges to access the Cisco ISE systems.

The following table lists the admin groups that are predefined in Cisco ISE, and the tasks that members from these groups can perform.

Table 5: Cisco ISE Admin Groups, Access Levels, Permissions, and Restrictions

Admin Group Role	Access Level	Permissions	Restrictions
Customization Admin	Manage sponsor, guest, and personal device portals.	<ul style="list-style-type: none"> • Configure guest and sponsor access. • Manage guest access settings. • Customize end-user web portals. 	<ul style="list-style-type: none"> • Cannot perform any policy management, identity management, or system-level configuration tasks in Cisco ISE. • Cannot view any reports.
Helpdesk Admin	Query monitoring and troubleshooting operations	<ul style="list-style-type: none"> • Run all reports. • Run all troubleshooting flows. • View the Cisco ISE dashboard and live logs. • View alarms. 	Cannot create, update, or delete reports, troubleshooting flows, live authentications, or alarms.

Admin Group Role	Access Level	Permissions	Restrictions
Identity Admin	<ul style="list-style-type: none"> • Manage user accounts and endpoints. • Manage identity sources. 	<ul style="list-style-type: none"> • Add, edit, and delete user accounts and endpoints. • Add, edit, and delete identity sources. • Add, edit, and delete identity source sequences. • Configure general settings for user accounts (attributes and password policy). • View the Cisco ISE dashboard, live logs, alarms, and reports. • Run all troubleshooting flows. 	Cannot perform any policy management or system-level configuration tasks in Cisco ISE.
MnT Admin	Perform all the monitoring and troubleshooting operations.	<ul style="list-style-type: none"> • Manage all the reports (run, create, and delete). • Run all the troubleshooting flows. • View the Cisco ISE dashboard and live logs. • Manage alarms (create, update, view, and delete). 	Cannot perform any policy management, identity management, or system-level configuration tasks in Cisco ISE.

Admin Group Role	Access Level	Permissions	Restrictions
Network Device Admin	Manage Cisco ISE network devices and network device repository.	<ul style="list-style-type: none">• Read and write permissions on network devices• Read and write permissions on Network Device Groups and all network resource object types.• View the Cisco ISE dashboard, live logs, alarms, and reports.• Run all the troubleshooting flows.	Cannot perform any policy management, identity management, or system-level configuration tasks in Cisco ISE.

Admin Group Role	Access Level	Permissions	Restrictions
Policy Admin	Create and manage policies for all the Cisco ISE services across the network, which are related to authentication, authorization, posture, profiler, client provisioning, and work centers.	<ul style="list-style-type: none"> • Read and write permissions on all the elements that are used in policies, such as authorization profiles, Network Device Groups (NDGs), and conditions. • Read and write permissions on identities, endpoints, and identity groups (user identity groups and endpoint identity groups). • Read and write permissions on services policies and settings. • View the Cisco ISE dashboard, live logs, alarms, and reports. • Run all the troubleshooting flows. • Device Administration—Access to device administration work centers. Permission for TACACS policy conditions and results. Network device permissions for TACACS proxy and proxy sequences. 	<p>Cannot perform any identity management or system-level configuration tasks in Cisco ISE.</p> <p>Device Administration—Access to the work center does not guarantee access to the subordinate links.</p>

Admin Group Role	Access Level	Permissions	Restrictions
RBAC Admin	All the tasks under the Operations menu, except for Endpoint Protection Services Adaptive Network Control, and partial access to some menu items under Administration .	<ul style="list-style-type: none"> • View the authentication details. • Enable or disable Endpoint Protection Services Adaptive Network Control • Create, edit, and delete alarms; generate and view reports; and use Cisco ISE to troubleshoot problems in your network. • Read permissions on administrator account settings and admin group settings • View permissions on admin access and data access permissions in the RBAC Policy window. • View the Cisco ISE dashboard, live logs, alarms, and reports. • Run all the troubleshooting flows. 	Cannot perform any identity management or system-level configuration tasks in Cisco ISE.

Admin Group Role	Access Level	Permissions	Restrictions
Super Admin	All Cisco ISE administrative functions. The default administrator account belongs to this group.	<p>Create, read, update, delete, and execute (CRUDX) permissions on all Cisco ISE resources.</p> <p>Note The super admin user cannot modify the default system-generated RBAC policies and permissions. To do this, you must create new RBAC policies with the necessary permissions based on your needs, and map these policies to an admin group.</p> <p>Device Administration—Access to device administration work centers. Permission for TACACS policy conditions and results. Network device permissions for TACACS proxy and proxy sequences. In addition, permission to enable TACACS global protocol settings.</p>	<ul style="list-style-type: none"> • Device Administration—Access to the work center does not guarantee access to the subordinate links. • Only an admin user from the default Super Admin Group can modify or delete other admin users. Even an externally mapped user who is part of an Admin Group cloned with the Menu and Data Access privileges of the Super Admin Group cannot modify or delete an admin user.

Admin Group Role	Access Level	Permissions	Restrictions
System Admin	All Cisco ISE configuration and maintenance tasks.	<p>Full access (read and write permissions) to perform all the activities under the Operations tab and partial access to some menu items under the Administration tab:</p> <ul style="list-style-type: none"> • Read permissions on administrator account settings and administrator group settings. • Read permissions on admin access and data access permissions along with the RBAC policy window. • Read and write permissions for all options under Administration > System. • View authentication details. • Enable or disable Endpoint Protection Services Adaptive Network Control • Create, edit, and delete alarms; generate and view reports; and use Cisco ISE to troubleshoot problems in your network. • Device Administration—Permission to enable TACACS global protocol settings. 	Cannot perform any policy management or system-level configuration tasks in Cisco ISE.

Admin Group Role	Access Level	Permissions	Restrictions
External RESTful Services (ERS) Admin	Full access to all the ERS API requests such as GET, POST, DELETE, PUT	<ul style="list-style-type: none"> • Create, read, update, and delete ERS API requests. 	The role is meant only for ERS authorization supporting internal users, identity groups, endpoints, endpoint groups, and SGT.
External RESTful Services (ERS) Operator	Read-only access to ERS API, only GET	<ul style="list-style-type: none"> • Can only read ERS API requests 	The role is meant only for ERS authorization supporting internal users, identity groups, endpoints, endpoint groups, and SGT.
TACACS+ Admin	Full access	Access to: <ul style="list-style-type: none"> • Device Administration Work Center. • Deployment—To enable TACACS+ services. • External ID stores. • Operations > TACACS Live Logs window. 	—

Related Topics

[Cisco ISE Administrators](#), on page 97

Create an Admin Group

The **Admin Groups** window allows you to view, create, modify, delete, duplicate, or filter Cisco ISE network admin groups.

Before you begin

To configure an external administrator group type, you must have already specified one or more external identity stores.

Step 1 Choose **Administration > System > Admin Access > Administrators > Admin Groups**.

Step 2 Click **Add**, and enter a name and description.

The supported special characters for the **Name** field are: space, # \$ & ' () * + - . / @ _ .

Step 3 Check the corresponding check box to specify the **Type** of administrator group you are configuring:

- **Internal:** Administrators assigned to this group type authenticate against the credentials that are stored in the Cisco ISE internal database.
- **External:** Administrators assigned to this group authenticate against the credentials stored in the external identity store that you select in the **Administration > System > Admin Access > Authentication > Authentication Method** window. You can specify the external groups, if required.

Note If an internal user is configured with an external identity store for authentication, while logging in to the ISE Admin portal, the internal user must select the external identity store as the **Identity Source**. Authentication will fail if **Internal Identity Source** is selected.

Step 4 Click **Add** in the **Member Users** area to add users to this admin group. To delete users from the admin group, check the check box corresponding to the user that you want to delete, and click **Remove**.

Step 5 Click **Submit**.

Administrative Access to Cisco ISE

Cisco ISE administrators can perform various administrative tasks based on the administrative group to which they belong. These administrative tasks are critical. Grant administrative access only to users who are authorized to administer Cisco ISE in your network.

Cisco ISE allows you to control administrative access to its web interface through the options described here.

Administrative Access Methods

You can connect to the Cisco ISE servers in several ways. The Policy Administration node (PAN) runs the Administrators portal. An admin password is required to log in. Other ISE persona servers are accessible through SSH or the console, where you run the CLI. This section describes the process and password options available for each connection type.

- **Admin password:** The Cisco ISE Admin user that you created during installation times out in 45 days by default. You can prevent that by turning off the password lifetime from **Administration > System > Admin Settings**. Click the **Password Policy** tab, and uncheck the **Administrative passwords expire** check box under **Password Lifetime**.

If you do not do this, and the password expires, you can reset the admin password in the CLI by running the **application reset-passwd** command. You can reset the Admin password by connecting to the console to access the CLI, or by rebooting the ISE image file to access the boot options menu.

- **CLI password:** You must enter a CLI password during installation. If you have a problem logging in to the CLI because of an invalid password, you can reset the CLI password. Connect to the console and run the **password** CLI command to reset the password. See the [Cisco Identity Services Engine CLI Reference Guide](#) for more information.
- **SSH access to the CLI:** You can enable SSH access either during installation or after, using the **service sshd** command. You can also force SSH connections to use a key. Note that when you do this, SSH connections to all the network devices also use that key. For more information, see [SSH Key Validation, on page 826](#). You can force the SSH key to use the Diffie-Hellman algorithm. Note that ECDSA keys are not supported for SSH keys.

Role-Based Admin Access Control in Cisco ISE

Cisco ISE provides role-based access control (RBAC) policies that ensure security by restricting administrative privileges. RBAC policies are associated with default admin groups to define roles and permissions. A standard set of permissions (for menu as well as data access) is paired with each of the predefined admin groups, and is thereby aligned with the associated role and job function.

Some features in the user interface require certain permissions for their use. If a feature is unavailable, or you are not allowed to perform a specific task, your admin group may not have the necessary permissions to perform the task that utilizes the feature.

Regardless of the level of access, any administrator account can modify or delete objects for which it has permission, on any window that it can access. Read-only functionality is unavailable for any administrative access.



Note Only system-defined admin users with Super Admin or Read Only Admin permissions can see the identity-based users who are not a part of a user group. Admins you create without these permissions cannot see these users.

Role-Based Permissions

Cisco ISE allows you to configure permissions at the menu and data levels. These are called menu access and data access permissions.

The menu access permissions allow you to show or hide the menu and submenu items of the Cisco ISE administrative interface. This feature lets you create permissions so that you can restrict or enable access at the menu level.

The data access permissions allow you to grant read and write, read only, or no access to the Admin Groups, User Identity Groups, Endpoint Identity Groups, Locations, and Device Types data in the Cisco ISE interface.

RBAC Policies

RBAC policies determine if an administrator can be granted a specific type of access to a menu item or other identity group data elements. You can grant or deny access to a menu item or identity group data element to an administrator based on the admin group, by using RBAC policies. When administrators log in to the Admin portal, they can access menus and data that are based on the policies and permissions defined for the admin groups with which they are associated.

RBAC policies map admin groups to menu access and data access permissions. For example, you can prevent a network administrator from viewing the Admin Access operations menu and the policy data elements. This can be achieved by creating a custom RBAC policy for the admin group with which that network administrator is associated.



Note If you are using customized RBAC policies for admin access, ensure that you provide all the relevant menu access for a given data access. For example, to add or delete endpoints with data access of Identity or Policy Admin, you must provide menu access to **Work Center > Network Access** and **Administration > Identity Management**.

Default Menu Access Permissions

Cisco ISE provides an out-of-the-box set of permissions that are associated with a set of predefined admin groups. Having predefined admin group permissions allow you to set permissions so that a member of any admin group can have full or limited access to the menu items within the administrative interface (known as menu access) and to delegate an admin group to use the data access elements of other admin groups (known as data access). These permissions are reusable entities that can be further used to formulate RBAC policies for various admin groups. Cisco ISE provides a set of system-defined menu access permissions that are already used in the default RBAC policies. Apart from the predefined menu access permissions, Cisco ISE also allows you to create custom menu access permissions that you can use in RBAC policies. The key icon represents menu access privileges for the menus and submenus, and the key with a close icon represents no access for different RBAC groups.



Note For a Super Admin user, all the menu items are available. For other admin users, all the menu items in the **Menu Access Privileges** column are available for standalone deployment and primary node in a distributed deployment. For secondary nodes in a distributed deployment, the menu items under the **Administration** tab are not available.

Configure Menu Access Permissions

Cisco ISE allows you to create custom menu access permissions that you can map to an RBAC policy. Depending on the role of the administrators, you can allow them to access only specific menu options.

Step 1 Choose **Administration > System > Admin Access > Authorization > Permissions > Menu Access**.

Step 2 Click **Add**, and enter values for the **Name** and **Description** fields.

- a) Expand the **ISE Navigation Structure** menu to the desired level, and click the options for which you want to create permissions.
- b) In the **Permissions for Menu Access** pane, click **Show**.

Step 3 Click **Submit**.

Prerequisites for Granting Data Access Permissions

When an RBAC admin has Full Access permission to an object (for example, Employee in the User Identity Groups data type), the admin can view, add, update, and delete users who belong to that group. Ensure that the admin has menu access permission granted for the **Users** window (**Administration > Identity Management > Identities > Users**). This is applicable for network devices and endpoints objects (based on the permissions granted to the Network Device Groups and Endpoint Identity Groups data types).

You cannot enable or restrict data access for network devices that belong to the default network device group objects—**All Device Types** and **All Locations**. All the network devices are displayed if Full Access data permission is granted to an object created under these default network device group objects. Therefore, we recommend that you create a separate hierarchy for the Network Device Groups data type, which is independent of the default network device group objects. You should assign the network device objects to the newly created Network Devices Groups to create restricted access.



Note You can enable or restrict data access permissions only for the User Identity Groups, Network Device Groups, and Endpoint Identity Groups, not to Admin Groups.

Default Data Access Permissions

Cisco ISE comes with a set of predefined data access permissions. These permissions enable multiple administrators to have the data access permissions within the same user population. You can enable or restrict the use of data access permissions to one or more admin groups. This process allows autonomous delegated control to administrators of one admin group to reuse data access permissions of the chosen admin groups through selective association. Data access permissions range from full access to no access for viewing selected admin groups or network device groups. RBAC policies are defined based on the administrator (RBAC) group, menu access, and data access permissions. You should first create menu access and data access permissions and then create an RBAC policy that associates an admin group with the corresponding menu access and data access permissions. The RBAC policy takes the form: If admin_group=Super Admin then assign SuperAdmin Menu Access permission + SuperAdmin Data Access permission. Apart from the predefined data access permissions, Cisco ISE also allows you to create custom data access permissions that you can associate with an RBAC policy.

There are three data access permissions, namely, Full Access, No Access, and Read Only access that can be granted to admin groups.

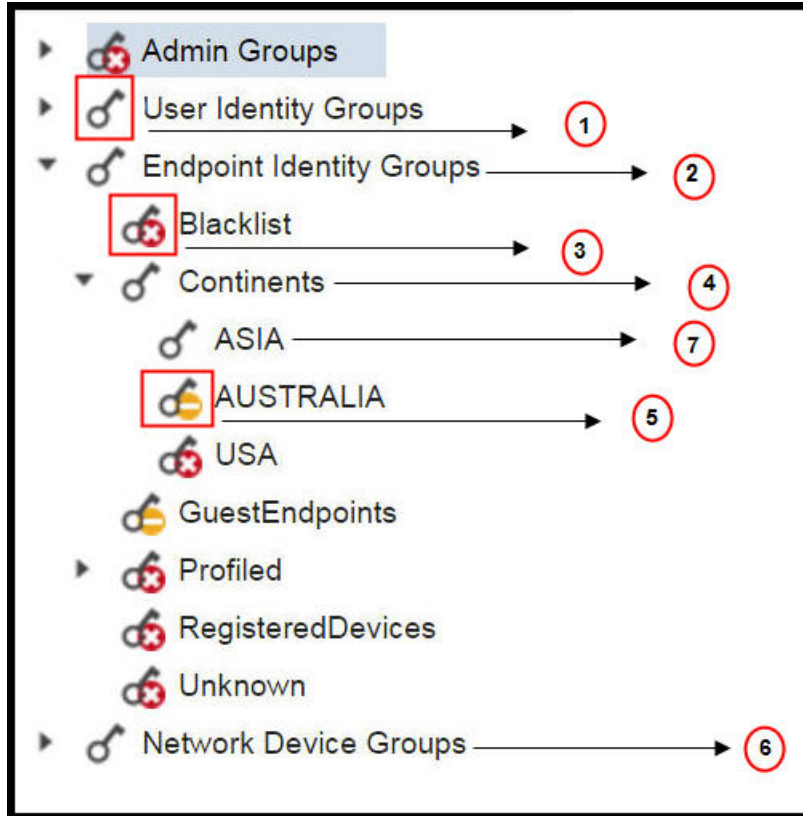
The Read Only permission can be granted to the following admin groups:

- Administration > Admin Access > Administrators > Admin Groups
- Administration > Groups > User Identity Group
- Administration > Groups > Endpoint Identity Groups
- Network Visibility > Endpoints
- Administration > Network Resources > Network Device Groups
- Administration > Network Resources > Network Devices
- Administration > Identity Management > Identities
- Administration > Identity Management > Groups > User Identity Groups
- Administration > Identity Management > Groups > Endpoint Identity Groups

If you have read-Only permission for a data type (for example, Endpoint Identity Groups), you will not be able to perform CRUD operations on that data type. If you have read-only permission for an object (for example, GuestEndpoints), you cannot perform edit or delete operations on that object.

The following image describes how Data Access Privileges apply at the second-level or third-level menu that contains additional submenus or options for different RBAC groups.

Figure 8: Data Access Privileges



Label	Description
1	Denotes full access for the User Identity groups data type.
2	Denotes that Endpoint Identity groups derive the maximum permission (full access) that is granted to its child (Asia).
3	Denotes that there is no access for the object (blocked list).
4	Denotes that the parent (Continents) derives the maximum access permission granted to its child (Asia).
5	Denotes Read-Only access for the object (Australia).
6	Denotes that when full access is granted to the parent (Network Device groups), it results in the children automatically inheriting permissions.

Label	Description
7	Denotes that when full access is granted to the parent (Asia), it results in the objects inheriting the Full Access permission, unless permissions are explicitly granted to the objects.

Configure Data Access Permissions

Cisco ISE allows you to create custom data access permissions that you can map to an RBAC policy. Based on the role of the administrator, you can choose to provide them access only to select data.

-
- Step 1** Choose **Administration > System > Admin Access > Authorization > Permissions**.
- Step 2** Choose **Permissions > Data Access**.
- Step 3** Click **Add**, and enter values for the **Name** and **Description** fields.
- Click to expand the admin group and select the corresponding admin group.
 - Click **Full Access**, **Read Only Access**, or **No Access**.
- Step 4** Click **Save**.
-

Configure Admin Access Policies

An RBAC policy is represented in an if-then format, where "if" is the RBAC Admin Group value and "then" is the RBAC Permissions value.

The RBAC policies window (**Administration > System > Admin Access > Authorization**) contains a list of default policies. You cannot edit or delete these default policies. The RBAC policies page also allows you to create custom RBAC policies for an admin group specifically for your work place, and apply to personalized admin groups.

When you assign limited menu access, make sure that the data access permissions allow the administrator to access the data that is required to use the specified menus. For example, if you give menu access to the MyDevices portal, but don't allow data access to Endpoint Identity Groups, then that administrator cannot modify the portal.



Note Admin users can move endpoint MAC addresses from the Endpoint Identity Groups they have read-only access to, to the Endpoint Identity Groups they have full access to. The other way around is not possible.

Before you begin

- Create all the admin groups for which you want to define the role-based access control (RBAC) policies.
- Ensure that these admin groups are mapped to individual admin users.
- Ensure that you have configured the RBAC permissions such as menu access and data access permissions.

-
- Step 1** Choose **Administration > System > Admin Access > Authorization > Policy**.
- The RBAC Policies page contains a set of ready-to-use predefined policies for default admin groups. You cannot edit or delete these default policies.
- Step 2** Click **Actions** next to any of the default RBAC policy rule.
- Here, you can insert new RBAC policies, duplicate an existing RBAC policy, and delete an existing RBAC policy.
- Step 3** Click **Insert new policy**.
- Step 4** Enter values for the Rule Name, RBAC Group(s), and Permissions fields.
- You cannot select multiple menu access and data access permissions when creating an RBAC policy.
- Step 5** Click **Save**.
-

Administrator Access Settings

Cisco ISE allows you to define some rules for administrator accounts to enhance security. You can restrict access to the management interfaces, force administrators to use strong passwords, regularly change their passwords, and so on. The password policy that you define in the Administrator Account Settings in Cisco ISE applies to all administrator accounts.

Cisco ISE supports administrator passwords with UTF-8 characters.

Configure Maximum Number of Concurrent Administrative Sessions and Login Banners

You can configure the maximum number of concurrent administrative GUI or CLI (SSH) sessions and login banners that help and guide administrators who access your administrative web or CLI interface. You can configure login banners that appear before and after an administrator logs in. By default, these login banners are disabled.

Before you begin

To perform the following task, you must be a Super Admin or System Admin.

-
- Step 1** Choose **Administration > System > Admin Access > Settings > Access > Session**.
- Step 2** Enter the maximum number of concurrent administrative sessions that you want to allow through the GUI and CLI interfaces. The valid range for concurrent administrative GUI sessions is from 1 to 20. The valid range for concurrent administrative CLI sessions is 1 to 10.
- Step 3** If you want Cisco ISE to display a message before an administrator logs in, check the **Pre-login banner** check box and enter your message in the text box.
- Step 4** If you want Cisco ISE to display a message after an administrator logs in, check the **Post-login banner** check box and enter your message in the text box.
- Step 5** Click **Save**.
-

Related Topics

[Allow Administrative Access to Cisco ISE from Select IP Addresses](#), on page 114

Allow Administrative Access to Cisco ISE from Select IP Addresses

Cisco ISE allows you to configure a list of IP addresses from which administrators can access the Cisco ISE management interfaces.

The administrator access control settings are only applicable to Cisco ISE nodes that assume the Administration, Policy Service, or Monitoring personas. These restrictions are replicated from the primary to the secondary nodes.

Before you begin

To perform the following task, you must be a Super Admin or System Admin.

Step 1 Choose **Administration > System > Admin Access > Settings > Access > IP Access**.

Step 2 Click the **Allow only listed IP addresses to connect** radio button.

Note Connection on Port 161 (SNMP) is used for administrative access. However, when IP Access restrictions are configured, the snmpwalk fails if the node from which it was performed is not configured for administrative access.

Step 3 In the **Configure IP List for Access Restriction** area, click **Add**.

Step 4 In the **Add IP CIDR** dialog box, enter the IP addresses in the classless interdomain routing (CIDR) format in the **IP Address** field.

Note This IP address can be an IPv4 or an IPv6 address. You can configure multiple IPv6 addresses for an ISE node.

Step 5 Enter the subnet mask in the **Netmask in CIDR format** field.

Step 6 Click **OK**. Repeat steps 4 to 7 to add more IP address ranges to this list.

Step 7 Click **Save** to save the changes.

Step 8 Click **Reset** to refresh the **IP Access** window.

Configure a Password Policy for Administrator Accounts

Cisco ISE also allows you to create a password policy for administrator accounts to enhance security. You can define whether you want a password-based or client certificate-based administrator authentication. The password policy that you define here is applied to all the administrator accounts in Cisco ISE.



- Note**
- Email notifications for internal admin users are sent to root@host. You cannot configure the email address, and many SMTP servers reject this email.
Follow open defect CSCui5583, which is an enhancement to allow you to change the email address.
 - Cisco ISE supports administrator passwords with UTF-8 characters.

Before you begin

- To perform the following task, you must be a Super Admin or System Admin.

- Turn off the automatic failover configuration, if this is enabled in your deployment. See [Support for Automatic Failover for the Administration Node, on page 9](#)

When you change the authentication method, you restart the application server processes. There might be a delay while these services restart. Due to this delay in restart of services, automatic failover of secondary administration node might get initiated.

Step 1 Choose **Administration > System > Admin Access > Authentication**.

Step 2 Click the radio button for one of the following authentication methods:

- **Password Based:** Choose this option to use the standard user ID and password credentials for administrator logins. Choose **Internal** or **External** from the **Identity Source** drop-down list.

Note If you have configured an external identity source such as LDAP and want to use that as your authentication source to grant access to the admin user, you must select that particular identity source from the Identity Source list box.

- **Client Certificate Based:** Choose this option to specify a certificate-based policy. From the **Certificate Authentication Profile** drop-down list, choose an existing authentication profile. Choose the required value from the **Identity Source** drop-down list.

Step 3 Click the **Password Policy** tab and enter the required values to configure the Cisco ISE GUI and CLI password requirements.

Step 4 Click **Save** to save the administrator password policy.

Note If you use an external identity store to authenticate administrators at login, note that even if this setting is configured for the password policy applied to the administrator profile, the external identity store will still validate the administrator's username and password.

Related Topics

[Administrator Password Policy Settings](#), on page 986

[Configure Account Disable Policy for Administrator Accounts](#), on page 115

Configure Account Disable Policy for Administrator Accounts

Cisco ISE allows you to disable an administrator account if the administrator account is not authenticated for the configured consecutive number of days.

Step 1 Choose **Administration > System > Admin Access > Authentication > Account Disable Policy**.

Step 2 Check the **Disable account after *n* days of inactivity** check box, and enter the number of days in the corresponding field.

This option allows you to disable the administrator account if the administrator account was inactive for the specified number of days. However, you can exclude individual administrator accounts from this account disable policy using the **Inactive Account Never Disabled** option in the **Administration > System > Admin Access > Administrators > Admin Users** window.

Step 3 Click **Save** to configure the global account disable policy for administrators.

Configure Session Timeout for Administrators

Cisco ISE allows you to determine the length of time an administration GUI session can be inactive and still remain connected. You can specify a time in minutes after which Cisco ISE logs out the administrator. After a session timeout, the administrator must log in again to access the Cisco ISE Admin portal.

Before you begin

To perform the following task, you must be a Super Admin or System Admin.

Step 1 Choose **Administration > System > Admin Access > Settings > Session > Session Timeout**.

Step 2 Enter the time in minutes that you want Cisco ISE to wait before it logs out the administrator if there is no activity. The default value is 60 minutes. The valid range is from 6 to 100 minutes.

Step 3 Click **Save**.

Terminate an Active Administrative Session

Cisco ISE displays all active administrative sessions from which you can select any session and terminate at any point of time, if a need to do so arises. The maximum number of concurrent administrative GUI sessions is 20. If the maximum number of GUI sessions is reached, an administrator who belongs to the super admin group can log in and terminate some of the sessions.

Before you begin

To perform the following task, you must be a Super Admin.

Step 1 Choose **Administration > System > Admin Access > Settings > Session > Session Info**.

Step 2 Check the check box next to the session ID that you want to terminate and click **Invalidate**.


Change Administrator Name

Cisco ISE allows you to change your username from the Cisco ISE GUI.

Before you begin

To perform the following task, you must be a Super Admin or System Admin.

Step 1 Log in to the Cisco ISE administration portal.

Step 2 Click the **Gear** icon () at the upper right corner of the Cisco ISE GUI, and choose **Account Settings** from the drop-down list.

Step 3 Enter the new username in the **Admin User** dialog box that is displayed.

Step 4 Edit any other details about your account that you want to change.

Step 5 Click **Save**.

Administrative Access to Cisco ISE Using an External Identity Store

In Cisco ISE, you can authenticate administrators via an external identity store such as Active Directory, LDAP, or RSA SecureID. There are two models you can use to provide authentication via an external identity store:

- **External Authentication and Authorization:** There are no credentials that are specified in the local Cisco ISE database for the administrator, and authorization is based on external identity store group membership only. This model is used for Active Directory and LDAP authentication.
- **External Authentication and Internal Authorization:** The administrator's authentication credentials come from the external identity source, and authorization and administrator role assignment take place using the local Cisco ISE database. This model is used for RSA SecurID authentication. This method requires you to configure the same username in both the external identity store and the local Cisco ISE database.

During the authentication process, Cisco ISE is designed to “fall back” and attempt to perform authentication from the internal identity database, if communication with the external identity store has not been established or if it fails. In addition, whenever an administrator for whom you have set up external authentication launches a browser and initiates a login session, the administrator still has the option to request authentication via the Cisco ISE local database by choosing **Internal** from the **Identity Store** drop-down list in the login dialog box.

Administrators who belong to a Super Admin group, and are configured to authenticate and authorize using an external identity store, can also authenticate with the external identity store for Command Line Interface (CLI) access.



Note You can configure this method of providing external administrator authentication only via the Admin portal. Cisco ISE CLI does not feature these functions.

If your network does not already have one or more existing external identity stores, ensure that you have installed the necessary external identity stores and configured Cisco ISE to access those identity stores.

External Authentication and Authorization

By default, Cisco ISE provides internal administrator authentication. To set up external authentication, you must create a password policy for the external administrator accounts that you define in the external identity stores. You can then apply this policy to the external administrator groups that eventually become a part of the external administrator RBAC policy.

To configure external authentication, you must:

- Configure password-based authentication using an external identity store.
- Create an external administrator group.
- Configure menu access and data access permissions for the external administrator group.
- Create an RBAC policy for external administrator authentication.

In addition to providing authentication via an external identity store, your network may also require you to use a Common Access Card (CAC) authentication device.

Configure a Password-Based Authentication Using an External Identity Store

You must first configure password-based authentication for administrators who authenticate using an external identity store such as Active Directory or LDAP.

-
- Step 1**
 - Step 2** On the **Authentication Method** tab, click **Password Based** and choose one of the external identity sources you have already configured. For example, the Active Directory instance that you have created.
 - Step 3** Configure any other specific password policy settings that you want for administrators who authenticate using an external identity store.
 - Step 4** Click **Save**.
-

Create an External Administrator Group

You will need to create an external Active Directory or LDAP administrator group. This ensures that Cisco ISE uses the username that is defined in the external Active Directory or LDAP identity store to validate the administrator username and password that you entered upon login.

Cisco ISE imports the Active Directory or LDAP group information from the external resource and stores it as a dictionary attribute. You can then specify that attribute as one of the policy elements while configuring the RBAC policy for this external administrator authentication method.

-
- Step 1** Choose **Administration > System > Admin Access > Administrators > Admin Groups**.
 - Step 2** Click **Add**.
 - Step 3** Enter a name and optional description.
 - Step 4** Click **External**.

If you have connected and joined to an Active Directory domain, your Active Directory instance name appears in the **Name** field.
 - Step 5** From the **External Groups** drop-down list box, choose the Active Directory group that you want to map for this external administrator group.

Click the “+” sign to map additional Active Directory groups to this external administrator group.
 - Step 6** Click **Save**.
-

Configure Menu Access and Data Access Permissions for External Administrator Group

You must configure menu access and data access permissions that can be assigned to the external administrator group.

-
- Step 1** Choose **Administration > System > Admin Access > Permissions**.
 - Step 2** Click one of the following:

- **Menu Access:** All administrators who belong to the external administrator group can be granted permission at the menu or submenu level. The menu access permission determines the menus or submenus that they can access.
- **Data Access:** All administrators who belong to the external administrator group can be granted permission at the data level. The data access permission determines the data that they can access.

Step 3 Specify menu access or data access permissions for the external administrator group.

Step 4 Click **Save**.

Create an RBAC Policy for External Administrator Authentication

You must configure a new RBAC policy to authenticate an administrator using an external identity store and to specify custom menu and data access permissions. This policy must have the external administrator group for authentication and the Cisco ISE menu and data access permissions to manage the external authentication and authorization.



Note You cannot modify an existing (system-preset) RBAC policy to specify these new external attributes. If you have an existing policy that you would like to use as a template, you must duplicate that policy, rename it, and then assign the new attributes.

Step 1 Choose **Administration > System > Admin Access > Authorization > Policy**.

Step 2 Specify the rule name, external administrator group, and permissions.

Remember that the appropriate external administrator group must be assigned to the correct administrator user IDs. Ensure that the administrator is associated with the correct external administrator group.

Step 3 Click **Save**.

If you log in as an administrator, and the Cisco ISE RBAC policy is not able to authenticate your administrator identity, Cisco ISE displays an “unauthenticated” message, and you cannot access the Admin portal.

Configure Admin Access Using an External Identity Store for Authentication with Internal Authorization

This method requires you to configure the same username in both the external identity store and the local Cisco ISE database. When you configure Cisco ISE to provide administrator authentication using an external RSA SecurID identity store, administrator credential authentication is performed by the RSA identity store. However, authorization (policy application) is still done according to the Cisco ISE internal database. In addition, there are two important factors to remember that are different from external authentication and authorization:

- You do not need to specify any particular external administrator groups for the administrator.
- You must configure the same username in both the external identity store and the local Cisco ISE database.

Step 1**Step 2**

Ensure that the administrator username in the external RSA identity store is also present in Cisco ISE. Ensure that you click the **External** option under Password.

Note You do not need to specify a password for this external administrator user ID, nor are you required to apply any specially configured external administrator group to the associated RBAC policy.

Step 3

Click **Save**.

External Authentication Process Flow

When the administrator logs in, the login session passes through the following steps in the process:

1. The administrator sends an RSA SecurID challenge.
2. RSA SecurID returns a challenge response.
3. The administrator enters a user name and the RSA SecurID challenge response in the Cisco ISE login dialog, as if entering the user ID and password.
4. The administrator ensures that the specified Identity Store is the external RSA SecurID resource.
5. The administrator clicks **Login**.

Upon logging in, the administrator sees only the menu and data access items that are specified in the RBAC policy.



CHAPTER 7

Cisco ISE Licenses

This chapter describes the licensing mechanism and schemes that are available for Cisco ISE and how to add and upgrade licenses.

- [Cisco ISE Licenses, on page 121](#)
- [Cisco ISE Smart Licensing, on page 122](#)
- [Manage Traditional License Files, on page 127](#)

Cisco ISE Licenses

Cisco ISE licensing offers two options to manage your licenses:

- **Smart Licensing:** Monitor Cisco ISE software licenses and endpoint license consumption easily and efficiently with a single token registration. The licenses that you purchase are maintained in a centralized database called the Cisco Smart Software Manager (CSSM). For more information about Smart Licensing, see [Cisco ISE Smart Licensing, on page 122](#).
- **Traditional Licensing:** Purchase and import individual licenses based on your needs and manage the application features and access, such as the number of concurrent endpoints that can use Cisco ISE network resources. For more information about Traditional Licensing, see [Manage Traditional License Files, on page 127](#).

To maximize economy for customers, licensing in Cisco ISE is supplied in different packages as Base, Plus, Apex, and Device Administration for both Traditional and Smart Licensing options. For more information about the Traditional Cisco licensing model, see [Cisco ISE Licensing Model, on page 127](#).

Once you have installed or upgraded your Cisco ISE box, Traditional Licensing is in use by default, and all license components are activated for a 90-day trial period. Once you switch to Smart Licensing, and before you register your token, this evaluation period remains active for the Smart Licensing, and the evaluation period includes all ISE licenses as part of that evaluation period. During the evaluation period, consumption is not reported to the CSSM.

You should update your installed licenses (for Traditional licensing) or license agreements (for Smart licensing) if:

- The trial period ends and you have not yet installed or registered your license.
- Your license has expired.
- If endpoint consumption exceeds your licensing agreement.

Cisco ISE will notify you of license expiration or consumption problems 90, 60, and 30 days in advance. Once the system is no longer compliant, the administrator will no longer be able to edit or configure Plus and Apex features. You can view and track licensing details from the **License Warning** icon at the top of the screen.

When upgrading from one licensing package to another more complex package, Cisco ISE will continue to offer all features that were available in the earlier package prior to upgrade and you will not need to re-configure any settings that you had already configured.

ISE Community Resource

[Cisco Identity Services Engine Ordering Guide](#)

For information on how to obtain evaluation licenses, see [How to Get ISE Evaluation Licenses](#).

Cisco ISE Smart Licensing

Cisco offers Smart Licensing, which enables you to monitor Cisco ISE software licenses and endpoint license consumption. You can monitor license usage easily and efficiently with a single registration token, rather than individually importing separate licenses. View and manage the details of all the Cisco products and licenses that you have purchased in a centralized database, the Cisco Smart Software Manager (CSSM). Log in to the CSSM portal to easily track the endpoint licenses that are available to you, and consumption statistics.

When a smart license token is active and registered in the Cisco ISE administration portal, the CSSM monitors the consumption of licenses by each endpoint session per product license. Smart Licensing notifies the administrator about license consumption by endpoint sessions with a simple table layout in Cisco ISE. Smart Licensing reports the peak usage of each enabled license to the centralized database daily. When licenses are available and not consumed, the administrator is notified of available licenses and can continue to monitor usage. When consumption exceeds the number of licenses available, an alarm is activated and the administrator is notified through alarms and notifications.

With Smart Licensing, you can also manage the different license entitlements included through your Cisco Smart Account, such as Base, Plus, Apex, or TACACS. From Cisco ISE, you can monitor basic consumption statistics per license entitlement. From your CSSM account, you can view additional information, statistics, and notifications, as well as make changes to your account and entitlements.



Note CSSM satellite is not supported.

Cisco ISE takes internal samples of license consumption every 30 minutes. License compliancy and consumption is updated accordingly. To view this information in the **Licenses** table in Cisco ISE, from the main menu, choose **Administration > System > Licensing**, and click **Refresh**.

From the time you register your Cisco ISE Primary Administration node (PAN) with the CSSM, Cisco ISE reports peak counts of license consumption to the CSSM server every six hours. The peak count reports help ensure that license consumption in Cisco ISE is in compliance with the licenses purchased and registered. Cisco ISE communicates with the CSSM server by storing a local copy of the CSSM certificate. The CSSM certificate is automatically reauthorized during the daily synchronization, and when you refresh the **Licenses** table. Typically, CSSM certificates are valid for six months.

If there is a change in the compliance status when Cisco ISE synchronizes with the CSSM server, the **Last Authorization** column of the **Licenses** table is updated accordingly. In addition, when entitlements are no

longer compliant, the number of days for which they are out of compliancy appears in the **Days Out of Compliance** column. Noncompliance is also indicated in the notifications displayed at the top of the **Licensing** area, and on the Cisco ISE toolbar next to the **License Warning** link. In addition to notifications, you can view alarms.



Note TACACS licenses are authorized when Cisco ISE communicates with the CSSM server, but they are not session-based, and therefore, no consumption count is associated with them in the **Licenses** table.

The compliance column of the **Licenses** table displays one of the following values:

- **In Compliance:** The use of this license is in compliance.
- **Released Entitlement:** The licenses have been purchased and released for use, but none have been consumed so far in this Cisco ISE deployment. In such a scenario, the **Consumption Count** for the license is 0.
- **Evaluation:** Evaluation licenses are available for use.

Figure 9: Licenses Table

License	Status	Compliance	Yesterday's Peak Count	Consumption Count*	Days Out of Compliance	Last Authorization
Base	Enabled	Released Entitlement	0	0	-	-
Plus	Enabled	Released Entitlement	0	0	-	-
Apex	Enabled	Released Entitlement	0	0	-	-
Tacacs	Enabled	In Compliance	Uncounted	Uncounted	-	May 19, 2016 3:25:55 PM

*Consumption Count Updated: May 19, 2016 17:00:00 IST

Activate and Register Smart Licensing in Cisco ISE

Before you begin

Activate Smart Licensing and then register from Cisco ISE using the token issued to you by your Cisco representative through your CSSM account.

Ensure you have the necessary ISE permissions in your Cisco Smart Software Manager (CSSM) account. For more information, see <https://software.cisco.com/> or contact your Cisco representative.

If you are upgrading from ISE-PIC, then prior to activating Smart Licensing with this procedure, you must first install the ISE Upgrade license and then:

- Install the Cisco ISE Base license.
- Or, move your PIC installation to an existing ISE deployment:
 1. From the existing Cisco ISE deployment, add another ISE node.
 2. Enable session profiling and pxGrid services from an existing Cisco ISE Administration node.

Step 1 Choose **Administration > System > Licensing** to access the **Licensing** area of ISE.

After you install or upgrade Cisco ISE, traditional licensing is in use by default. The licensing mode appears at the top of the screen in the **Licensing Method** area of ISE:

Figure 10: Traditional Licensing



- Step 2** Click the **Cisco Smart Licensing** link from the **Licensing Method** area to switch to **Smart Licensing**. The **Cisco Smart Licensing** area expands with connection method fields.


Figure 11: Smart Licensing Connection Method Details

Specify the method to use to connect to Cisco Smart Software Manager and then click Enable to get Started.

Connection Method

Optional Secondary administration node for high availability.

Secondary UDI

 Cisco cloud server information

- Step 3** From the **Cisco Smart Licensing** area, in the Secondary UDI field, if at least one additional ISE box is configured in your network, enter the secondary node you to be used if the Primary node is not available. Select a connection method by which to connect from your ISE box to the CSSM from the **Connection Method** dropdown list and click **Enable**. For **Connection Method**, choose:

- Direct HTTPS** if you have a direct connection configured to reach the Internet.
- HTTPS Proxy** if you do not have a direct connection and need to connect by proxy.
- Transport Gateway** is the recommended connection method.

When you use Smart Licensing, Smart Call Home (SCH) services are automatically activated as well, enabling you to configure a Transport Gateway. To configure Transport Gateway as your connection method, first configure it from the Smart Call Home settings in the Administration work center. To do this, and for additional information about SCH and Transport Gateway, see the Smart Call Home section in the *Cisco ISE Admin Guide*.

Note After activating Smart Licensing, you have a 90-day evaluation period. During this time, all licenses are active. During this time, you can explore Smart Licensing and all the Cisco ISE features. If you don't register Smart Licensing with a valid token before the evaluation period expires, you cannot use Cisco ISE.

The fields in this area are dynamic. After you enter the connection details and click **Enable**, the area collapses. When you expand the area again, is now called **Cisco Smart Licensing Registration**, and you can enter smart licensing token details.

Step 4 From the **Cisco Smart Licensing Registration** area in ISE, enter the **Registration Token** you received when you purchased the smart licensing token, and click **Register**. To retrieve the token at any time, go to the ISE area of your CSSM account and click **Copy**.

You can disable any of the licenses in your smart licensing token by unchecking the checkboxes. When you disable the licenses, Smart Licensing no longer automatically validates those licenses.

Smart Licensing for Air-Gapped Networks

An air-gapped network does not allow any communication between a secured network and an external network. Cisco ISE Smart Licensing requires Cisco ISE to communicate with the CSSM. If your network is air-gapped, Cisco ISE is unable to report license usage to CSSM and this lack of reporting results in the loss of administrative access to Cisco ISE and restrictions in Cisco ISE features.

To avoid licensing issues in air-gapped networks and enable full Cisco ISE functionality, you can configure a Smart Software Manager (SSM) On-Premises server. This licensing method is available in releases.

You must configure an SSM On-Prem and ensure that Cisco ISE can reach this server. This server takes over the role of CSSM in your air-gapped network, releasing license entitlements, as needed, and tracking usage metrics. The SSM On-Prem server also sends notifications, alarms, and warning messages that are related to licensing consumption and validity.

Configure Smart Software Manager On-Prem for Smart Licensing

Before you begin

Configure an SSM On-Prem server and ensure that Cisco ISE can reach this server. For more information, see [Smart Software Manager On-Prem Resources](#).

If you buy more licenses or modify your license purchases, you must connect the SSM On-Prem server to CSSM for the changes to be available in your local server.



Note ISE-PIC 2.7 and earlier do not support Smart Licensing.

Step 1 Choose **Administration > System > Licensing**.

Step 2 Click **Cisco Smart Licensing**.

Step 3 Choose **SSM On-Prem Server** from the **Connection Method** drop-down list.

The **Certificate** window in the SSM On-Prem portal displays either the IP address or the hostname (or FQDN) of the connected SSM On-Prem server.

Step 4 Enter the configured IP address or the hostname (or FQDN) in the **SSM On-Prem server Host** field.

Step 5 In the **Tier** and **Virtual Appliance** areas, check the check boxes for all the licenses you need to enable. The chosen licenses are activated and their consumption is tracked by CSSM.

Step 6 Click **Register**.

Note Ensure that port 443 and the port used for ICMP communication are open while registering Cisco ISE with SSM On-Prem server.

Manage Smart Licensing in Cisco ISE

After you activate and register your Smart Licensing token, you can manage license entitlements from Cisco ISE by:

- Enabling, disabling, and refreshing license entitlement certificates.
- Updating Smart Licensing registration.
- Identifying compliant and noncompliant licensing issues.

Before you begin

Ensure that you have activated and registered your Smart Licensing token. For more information, see [Activate and Register Smart Licensing in Cisco ISE, on page 123](#).

-
- Step 1** (Optional) When you first activate Smart Licensing, all the license entitlements are enabled automatically as part of the Evaluation Mode. After you register your license token, if your CSSM account does not include certain entitlements and you did not disable them during registration, noncompliant notifications are displayed in Cisco ISE. Add those entitlements to your CSSM account (contact your CSSM account representative for assistance), and then, in the **Licenses** table, click **Refresh** to remove noncompliant notifications and continue to use the related features. After you refresh the authorization, log out and then log back in to Cisco ISE for the relevant noncompliance messages to be removed.
- Step 2** (Optional) If the daily automatic authorization does not succeed for any reason, noncompliance messages may appear. Click **Refresh** to reauthorize your entitlements. After you refresh the authorization, log out and then log back in to Cisco ISE for the relevant noncompliance messages to be removed.
- Step 3** (Optional) When you first activate Smart Licensing, all license entitlements are enabled automatically as part of the evaluation period. After you register your token, if your CSSM account does not include certain entitlements and you did not disable them during registration, you can still disable those entitlements from Smart Licensing in ISE in order to avoid unnecessary noncompliant notifications. From the **Licenses** table, check the check boxes for the license entitlements that are not included in your token, and click **Disable** from the toolbar. After you have disabled license entitlements, log out and then log back in to Cisco ISE for the relevant features to be removed from the menus and for the noncompliance messages to be removed.
- Step 4** (Optional) After you add entitlements to your account, enable those entitlements. From the **Licenses** table, check the check boxes for the required disabled licenses, and click **Enable** from the toolbar.
- Step 5** (Optional) If you initially set-up Smart Licensing with only one UDI and do not enter a Secondary UDI, you can later update your information. Click the **Cisco Smart Licensing Registration Details** link to open the area. Re-enter the token, enter the new **Secondary UDI** and click **Update**.
- Step 6** (Optional) The registration certificate is automatically refreshed every six months. To manually refresh your Smart Licensing certificate registration, click **Renew Registration** from the top of the **Licensing** window.
- Step 7** (Optional) To remove your Cisco ISE box registration (indicated by UDIs) from your Smart Account, but continue to use Smart Licensing till the end of the evaluation period, click **Deregister** from the top of the **Cisco Smart Licensing** area. You can do this, for example, if you need to change the UDIs you have indicated as part of the registration process. If you still have time remaining in your evaluation period, Cisco ISE remains in Smart Licensing. If your evaluation period is at an end, a notification appears when the browser is refreshed. After you deregister your smart license, you can

follow the registration process again in order to register with the same or different UDIs. For more information about activating and registering your Smart Licensing, see [Activate and Register Smart Licensing in Cisco ISE, on page 123](#).

Step 8

(Optional) To remove your Cisco ISE box registration (indicated by UDIs) from your Smart Account entirely, and to revert to traditional licensing, click **Disable** from the top of the **Cisco Smart Licensing** area. You can do this, for example, if you need to change the UDIs you have indicated as part of the registration process. After you disable the smart license, follow the registration process again in order to activate and register with the same or different UDIs. For more information about activating and registering your Smart Licensing, see [Activate and Register Smart Licensing in Cisco ISE, on page 123](#).

Manage Traditional License Files

To continue to use Cisco ISE services after the 90-day Evaluation license expires, and to support more than 100 concurrent endpoints on the network, you must obtain and register Base licenses for the number of concurrent users on your system. If you require additional functionality, you will need Plus and/or Apex licenses to enable that functionality.

Licenses are uploaded to the Primary Policy Administration Node and propagated to the other Cisco ISE nodes in the cluster. Licenses are centrally managed by the Administration node, the other nodes do not require separate licenses. If you have two Administration nodes deployed in a high-availability pair, you must ensure that each of them have the same license capabilities. Generate the license with both the UDIs of the Primary and the Secondary Policy Administration Nodes and then add the license to the Primary Policy Administration Node.

After you install the Cisco ISE software and initially configure the appliance as the PAN, you must obtain a license for Cisco ISE and then register that license. You register all licenses to the PAN via the Primary and Secondary Administration Node hardware UDI. The PAN then centrally manages all the licenses that are registered for your deployment.



Note When a node is deregistered from the PAN, it becomes a standalone node and its license is reset to Evaluation.

This section explains how to register, re-host, renew, migrate, upgrade, and remove Traditional ISE licenses.

- [Register Licenses, on page 133](#)
- [Re-Host Licenses, on page 134](#)
- [Renew Licenses, on page 134](#)
- [Migrate and Upgrade Licenses, on page 134](#)
- [Remove Licenses, on page 135](#)

Cisco ISE Licensing Model

Cisco ISE licensing model allows you to purchase licenses based on your enterprise's needs. When using Traditional Licensing, you import all individual licenses and continue to manage them individually from ISE. When using Smart Licensing, you manage a centralized Cisco account, which contains all information about the different endpoint licenses you have purchased.

Valid license options include:

- ISE Base only
- ISE Base and Plus
- ISE Base and Apex
- ISE Base and Device Administration
- ISE Base, Plus, Apex, and Device Administration
- ISE Base, Plus, Apex and AnyConnect Apex

The number of Plus license sessions can be up to the number of Base license sessions on the deployment. The same stands for Apex license sessions. Apex and Plus licenses can be installed independently without any restriction on the number of Apex versus Plus licenses. Cisco ISE licenses are based on the number of concurrent endpoints with active network connections whereas AnyConnect Apex licenses are on a per user basis. AnyConnect Apex license count can exceed Cisco ISE Base license count.



Note The services contained within the Plus license, most notably profiling, are frequently used across the entire deployment. When you add Plus licenses to the deployment, we recommend that the Plus license count be equal to the Base license count. However, you might have a situation where the Plus license services might not be needed across the entire deployment, which is why Cisco ISE allows the Plus license count to be less than the Base license count.

Cisco recommends installing (for Traditional Licensing), or purchasing (for Smart Licensing) Base, Plus, and Apex licenses at the same time.

- Base licenses are required to use the services enabled by Plus and/or Apex licenses. However, you do not need a Plus license in order to have an Apex license or vice versa, since there is no overlap in their functionality.
- When you install a Base or Mobility Upgrade license, Cisco ISE continues to use the default Evaluation license as a separate license for the remainder of its duration.
- When you install a Mobility Upgrade license, Cisco ISE enables all Wired, Wireless, and VPN services.
- A Base or Mobility license is required to install the Device Administration license.
- You cannot upgrade the Evaluation license to a Plus license without first installing the Base license.

If you only have VM Small licenses, but your VM node has the resources mapped to a VM Medium license, Cisco ISE will register the consumption of a VM Medium license. You will receive notifications of out-of-compliance license consumption. You must procure and install the appropriate license to stop receiving these notifications.

You can install multiple VM licenses based on the number of VMs and their resources as per your deployment requirements.

If you have not purchased a Cisco ISE VM license before, refer to the [ISE Ordering Guide](#) to choose the appropriate VM license. If you have Cisco ISE VM licenses with no associated Product Authorization Keys (PAK), contact the Cisco licensing team with the Sales Order numbers of your Cisco ISE VM purchases. Your request will be processed to provide one medium VM license key for each ISE VM purchase made.

For assistance with licensing issues of lower severity levels, open a case online through the Support Case Manager, at <http://cs.co/scmswl>.

For Cisco TAC assistance with critical issues, refer to the contact information provided at <http://cs.co/TAC-worldwide>.

Table 6: Cisco ISE License Packages

ISE License Packages	Perpetual/Subscription (Terms Available)	ISE Functionality Covered	Notes
Base	Perpetual	<ul style="list-style-type: none"> • Basic network access (AAA, IEEE-802.1X) • Guest services • Link encryption (MACSec) • TrustSec • ISE Application Programming Interfaces 	Passive identity services available as part of the upgrade from ISE-PIC to a Base license include limited pxGrid features available to Cisco subscribers only.
Plus	Subscription (1, 3, or 5 years)	<ul style="list-style-type: none"> • Bring Your Own Device (BYOD)—when consuming either a built-in or an external certificate authority • MSE integration for location services • Profiling and Feed Services • Adaptive Network Control (ANC) • Cisco pxGrid 	<p>Does not include Base services; a Base license is required to install the Plus license.</p> <p>When onboarding an endpoint with the BYOD flow, the Plus services are consumed on the active session even when related BYOD attributes are not in use.</p> <p>Plus licenses are supposed to be consumed when profiling-related authorization policies contain IdentityGroup:Name.</p>

Apex	Subscription (1, 3, or 5 years)	<ul style="list-style-type: none"> • Third Party Mobile Device Management (MDM) integration • Posture Compliance • TC NAC 	<p>Does not include Base services; a Base license is required to install the Apex license.</p> <p>Note When you use Cisco AnyConnect as unified posture agent across wired, wireless, and VPN deployments, you need Cisco AnyConnect Apex user licenses in addition to Cisco ISE Apex licenses.</p>
Mobility	Subscription (1, 3, or 5 years)	Combination of Base, Plus, and Apex for wireless and VPN endpoints	Cannot coexist on a Cisco Administration node with Base, Plus, and/or Apex licenses.
Mobility Upgrade	Subscription (1, 3, or 5 years)	Provides wired support to Mobility license	You can only install a Mobility Upgrade license on top of an existing Mobility license.
Device Administration	Perpetual	TACACS+	<p>A Base or Mobility license is required to install the Device Administration license.</p> <p>Only one license is required per deployment (regardless of multiple nodes).</p>
ISE-PIC	Perpetual	Passive identity services	One license per node. Each license supports up to 3,000 parallel sessions.
ISE-PIC upgrade	Perpetual	<p>This license allows these options:</p> <ul style="list-style-type: none"> • Enable additional (up to 300,000) parallel sessions. • Upgrade to full ISE instance 	<p>One license per node. Each license supports up to 300,000 parallel sessions.</p> <p>After installing this license, the upgraded node can join an existing ISE deployment or alternatively, base licenses can be installed on the node to function as the PAN.</p> <p>Passive identity services available as part of the upgrade to a Base license include limited pxGrid features available to Cisco subscribers only.</p>

Evaluation	Temporary (90 days)	Full Cisco ISE functionality is provided for 100 endpoints.	All Cisco ISE appliances are supplied with an Evaluation license.
------------	---------------------	---	---

Traditional License Consumption

You purchase licenses for the number of concurrent users on the system with Traditional Licensing. A Cisco ISE user consumes a license during an active session (always a Base; and a Plus and an Apex license, if you use the functionality covered by these licenses). Once the session ends, the license is released for reuse by other users.



Restriction Cisco ISE license architecture consumption logic relies on authorization policy constructs. Cisco ISE uses the dictionaries and attributes within authorization rules to determine the license to use.

The Cisco ISE license is counted as follows:

- A Base license is consumed for every active session. The same endpoint also consumes Plus and Apex licenses depending on the features that it is using.



Note TACACS+ sessions do not consume a base license, but RADIUS sessions consume a base license.

- The endpoint consumes the Base license before it consumes a Plus and Apex license.
- The endpoint consumes the Plus license before it consumes an Apex license.
- One Plus license is consumed per endpoint for any assortment of the license's features. Likewise, one Apex license is consumed per endpoint for any assortment of its features.
- Licenses are counted against concurrent, active sessions.
- Licenses are released for all features when the endpoint's session ends.
- pxGrid is used to share context collected by ISE with other products. A Plus license is required to enable pxGrid functionality. There is no session count decrement when context for session is shared. However, to use pxGrid, the number of Plus sessions licensed must be equal to the number of Base sessions licensed. For more information, see Cisco ISE Licenses and Services section in [Cisco Identity Services Engine Ordering Guide](#).
- One AnyConnect Apex user license is consumed by each user who uses AnyConnect regardless of the number of devices that the user owns and whether or not the user has an active connection to the network.
- You can enable the TACACS+ service by adding a Device Administration license on top of an existing Base or Mobility license. This feature does not consume licenses.

To avoid service disruption, Cisco ISE continues to provide services to endpoints that exceed license entitlement. Cisco ISE instead relies on RADIUS accounting functions to track concurrent endpoints on the network and generates an alarm when the endpoint count of the previous day exceeded the amount of licenses. You can

view license consumption clearly from the **License Usage** area in the **Licensing** screen, where licenses that are consumed beyond the permitted quantity appear in red in the line graph.

In addition, you can view and track detailed information per license package from the **License Warning** icon at the top of the screen.

View License Consumption

You can view your system's current license consumption from the Licensing dashboard at: **Administration > System > Licensing**. Consumption is portrayed as in the following image:

Figure 12: Traditional License Consumption



The License Consumption graph, in the **License Usage** area, is updated every 30 minutes. This window also displays the type of licenses purchased, the total number of concurrent users permitted on the system, and the expiry date of subscription services.

If you want to see your system's license consumption over multiple weeks, click **Usage Over Time**. Each bar in the graph shows the maximum number of licenses used during a period of one week.

Unregistered License Consumption

Issue

Endpoint license consumption relies on the attributes that are used in the authorization policy with which an endpoint is matched.

Consider a scenario where you only have a Cisco ISE Base license registered in your system (you deleted the 90-day Evaluation license). You will be able to see and configure the corresponding Cisco ISE Base menu items and features.

If you configure an authorization policy to use a feature, for example, if you use the `Session:PostureStatus` attribute that requires an Apex license, and an endpoint matches this authorization policy, then:

- The endpoint consumes an Cisco ISE Apex license, despite the fact that a Cisco Apex license has not been registered in the system.
- You see notifications of noncompliant license consumption whenever you log in.
- Cisco ISE displays notifications and alarms with the message `Exceeded license usage than allowed`. This is because there are no Cisco ISE Apex licenses that are registered in CSSM for your Cisco ISE, but an endpoint is consuming one.



Note The licensing alarm is displayed for about 60 days from the first occurrence of non-compliant license use, even if you fix the licensing issue by registering the necessary licenses.

Possible Causes

Because of the configuration of an authorization policy, the **Licensing** table reports that Cisco ISE has used a license that you have not purchased and registered. Before you purchase Plus or an Apex license, the Cisco ISE administration portal does not display the features covered by these licenses. However, after you purchase these licenses, the GUI continues to display the features that they enable even after the license has expired or endpoint consumption of the license has exceeded a set limit. Thus, you can configure the features even if you do not currently have a valid license for them.

Solution

In the Cisco ISE administration portal, click the **Menu** icon (☰) and choose **Policy > Authorization**, identify the authorization rule that is using the feature for which you do not have a registered license, and reconfigure that rule.

Manage License Files

This section explains how to register, re-host, renew, migrate, upgrade, and remove ISE licenses:

- [Register Licenses, on page 133](#)
- [Re-Host Licenses, on page 134](#)
- [Renew Licenses, on page 134](#)
- [Migrate and Upgrade Licenses, on page 134](#)
- [Remove Licenses, on page 135](#)

Register Licenses

Before you begin

Consult your Cisco partner/account team about the types of licenses and number of concurrent users you require for your installation, together with the various packages you can purchase to maximize economy.

-
- Step 1** From the ordering system (Cisco Commerce Workspace - CCW) on Cisco's website www.cisco.com, order the required licenses.
- After about an hour, an email confirmation containing the Product Authorization Key (PAK) is sent.
- Step 2** From the Cisco ISE Administration portal, choose **AdministrationSystemLicensing**. Make a note of the node information in the **Licensing Details** section: Product Identifier (PID), Version Identifier (VID), and Serial Number (SN).
- Step 3** Go to www.cisco.com/go/licensing, and where prompted, enter the PAK of the license you received, the node information, and some details about your company.

The PAK number can be obtained from the sticker located on the software's CD sleeve or on a License Claim Certificate that was physically mailed to you. Post license registration, the permanent license will be sent to your provided email address. Licenses are sent from licensing@cisco.com, add this address to your safe senders list to receive emails from this mailer.

- Step 4** Save this license file to a known location on your system.
- Step 5** From the Cisco ISE Administration portal, choose **Administration > System > Licensing**. In the **License Files** section, click the **Import License** button.
- Step 6** Click **Choose File** and select the license file you previously stored on your system.
- Step 7** Click **Import**.

The new license is now installed on your system.

What to do next

Choose the licensing dashboard, **Administration > System > Licensing**, and verify that the newly-entered license appears with the correct details.

Re-Host Licenses

Re-hosting means moving a license from one Cisco ISE node to another. From the licensing portal, you select the PAK of the license you want to move and follow the instructions for re-hosting. After one day, you are sent an email with a new PAK. You then register this new PAK for the new node, and remove the old license from the original Cisco ISE node.

Renew Licenses

Subscription licenses, such as Plus and Apex licenses, are issued for 1, 3 or 5 years. Cisco ISE sends an alarm when licenses are near their expiration date and again when the licenses expire.

Licenses must be renewed after they expire. This process is carried out by your Cisco partner or account team only.

Migrate and Upgrade Licenses

Cisco licensing policy supports migration from previous Cisco ISE versions, upgrading from wireless and VPN only to include wired deployments, and adding concurrent users and functionality. You can also purchase bundles of licenses to minimize your ongoing expenses. These scenarios are all covered in the [licensing site](#), or for more information contact your Cisco partner/account team.



Note If you have migrated from Cisco ISE version 1.2, your Advanced license covers all the features in both Plus and Apex licenses.



Note After upgrading from Cisco ISE version 1.3 or 1.4, the system will show the default Evaluation license only if it existed on the system prior to upgrade.



Note Mobility/Mobility Upgrade license is always displayed as Base/Plus/Apex in the user interface with its corresponding number of end points.

If your Cisco ISE node needs to support:

- A larger number of concurrent users than the number for which you have licenses
- Wired (LAN) access, and your system has only the Mobility license

You will need to upgrade your license(s) for that node. This process is carried out by your Cisco partner or account team only.

Remove Licenses

Before you begin

Keep the following in mind before attempting to remove a license:

- If you have installed a Mobility Upgrade license after a Mobility license, you must remove the Mobility Upgrade license before you can remove the underlying Mobility license.
- If you install a combined license, all related installations in the Base, Plus, and Apex packages are also removed.

Step 1 Choose **Administration > System > Licensing**

Step 2 In the **License Files** section, click the check next to the relevant file name, and click **Delete License**.

Step 3 Click **OK**.



CHAPTER 8

Manage Certificates

- [Certificate Management in Cisco ISE, on page 137](#)
- [Cisco ISE CA Service, on page 165](#)
- [OCSP Services, on page 192](#)
- [Requirements for CA to Interoperate with Cisco ISE, on page 195](#)

Certificate Management in Cisco ISE

A certificate is an electronic document that identifies an individual, a server, a company, or another entity, and associates that entity with a public key. A self-signed certificate is signed by its creator. Certificates can be self-signed or digitally signed by an external CA. A CA-signed digital certificate is considered an industry standard and more secure than a self-signed certificate.

Certificates are used in a network to provide secure access. Certificates identify a Cisco ISE node to an endpoint and secure the communication between that endpoint and the Cisco ISE node.

Cisco ISE uses certificates for:

- Communication between Cisco ISE nodes.
- Communication between Cisco ISE and external servers such as the syslog and feed servers.
- Communication between Cisco ISE and end user portals such as guest, sponsor and BYOD portals.

Manage certificates for all the nodes in your deployment through the Cisco ISE administration portal.

Configure Certificates in Cisco ISE to Enable Secure Access

Cisco ISE relies on public key infrastructure (PKI) to provide secure communication with both endpoints and administrators and between Cisco ISE nodes in a multinode deployment. PKI relies on X.509 digital certificates to transfer public keys for encryption and decryption of messages, and to verify the authenticity of other certificates representing users and devices. Through the Cisco ISE administration portal, you can manage two categories of X.509 certificates:

- **System Certificates:** These are server certificates that identify a Cisco ISE node to client applications. Every Cisco ISE node has its own system certificates that are stored on the node along with the corresponding private keys.



Note Cisco ISE cannot import more than one certificate with the same private key. If the certificate is renewed and imported without changing the private key, then the existing certificate is replaced with the imported certificate.

- **Trusted Certificates:** These are CA certificates that are used to establish trust for the public keys that are received from users and devices. The Trusted Certificates store also contains certificates that are distributed by the Simple Certificate Enrollment Protocol (SCEP), which enables the registration of mobile devices into the enterprise network. Trusted certificates are managed on the primary PAN, and are automatically replicated to all the other nodes in a Cisco ISE deployment.

In a distributed deployment, you must import the certificate only into the Certificate Trust List (CTL) of the PAN. The certificate gets replicated to the secondary nodes.

To ensure certificate authentication in Cisco ISE is not impacted by minor differences in certificate-driven verification functions, use lowercase hostnames for all Cisco ISE nodes that are deployed in a network.

Certificate Usage

When you import a certificate into Cisco ISE, specify the purpose for which the certificate is to be used. Choose **Administration > System > Certificates > System Certificates**, and click **Import**.

Choose one or more of the following uses:

- **Admin:** For internode communication and authenticating the administration portal.
- **EAP Authentication:** For TLS-based EAP authentication.
- **RADIUS DTLS:** For RADIUS DTLS server authentication.
- **Portal:** For communicating with all Cisco ISE end-user portals.
- **SAML:** For verifying that the SAML responses are being received from the correct identity provider.
- **pxGrid:** For communicating with the pxGrid controller.

Associate different certificates from each node for communicating with the administration portal (Admin usage), the pxGrid controller (pxGrid usage), and for TLS-based EAP authentication (EAP Authentication usage). However, you can associate only one certificate from each node for each of these purposes.

With multiple PSNs in a deployment that can service a web portal request, Cisco ISE needs a unique identifier to identify the certificate that must be used for portal communication. When you add or import certificates that are designated for portal use, define a certificate group tag and associate it with the corresponding certificate on each node in your deployment. Associate this certificate group tag to the corresponding end-user portals (guest, sponsor, and personal devices portals). This certificate group tag is the unique identifier that helps Cisco ISE identify the certificate that must be used when communicating with each of these portals. You can only designate one certificate from each node for each of the portals.



Note An EAP-TLS client certificate should have KeyUsage=Key Agreement and ExtendedKeyUsage=Client Authentication for the following ciphers:

- ECDHE-ECDSA-AES128-GCM-SHA256
- ECDHE-ECDSA-AES256-GCM-SHA384
- ECDHE-ECDSA-AES128-SHA256
- ECDHE-ECDSA-AES256-SHA384

An EAP-TLS client certificate should have KeyUsage=Key Encipherment and ExtendedKeyUsage=Client Authentication for the following ciphers:

- AES256-SHA256
- AES128-SHA256
- AES256-SHA
- AES128-SHA
- DHE-RSA-AES128-SHA
- DHE-RSA-AES256-SHA
- DHE-RSA-AES128-SHA256
- DHE-RSA-AES256-SHA256
- ECDHE-RSA-AES256-GCM-SHA384
- ECDHE-RSA-AES128-GCM-SHA256
- ECDHE-RSA-AES256-SHA384
- ECDHE-RSA-AES128-SHA256
- ECDHE-RSA-AES256-SHA
- ECDHE-RSA-AES128-SHA
- EDH-RSA-DES-CBC3-SHA
- DES-CBC3-SHA
- RC4-SHA
- RC4-MD5

To bypass this requirement, choose **Administration > System > Settings > Security Settings** and check the **Accept certificates without validating purpose** checkbox.

Certificate Matching in Cisco ISE

When you set up Cisco ISE nodes in a deployment, the nodes communicate with each other. The system checks the FQDN of each Cisco ISE node to ensure that they match (for example `ise1.cisco.com` and `ise2.cisco.com` or if you use wildcard certificates then `*.cisco.com`). In addition, when an external machine presents a certificate to a Cisco ISE server, the external certificate that is presented for authentication is checked (or matched) against the certificate in the Cisco ISE server. If the two certificates match, the authentication succeeds.

For Cisco , matching is performed between the nodes (if there are two), and between Cisco and pxGrid.

Cisco ISE checks for a matching subject name as follows:

1. Cisco ISE looks at the subject alternative name extension of the certificate. If the subject alternative name contains one or more DNS names, then one of the DNS names must match the FQDN of the Cisco ISE node. If a wildcard certificate is used, then the wildcard domain name must match the domain in the Cisco ISE node's FQDN.
2. If there are no DNS names in the subject alternative name, or if the subject alternative name is missing entirely, then the common name in the **Subject** field of the certificate or the wildcard domain in the **Subject** field of the certificate must match the FQDN of the node.
3. If no match is found, the certificate is rejected.



Note X.509 certificates that are imported into Cisco ISE must be in privacy-enhanced mail (PEM) or distinguished encoding rule format. Files containing a certificate chain (a system certificate along with the sequence of trust certificates that sign it) can be imported, subject to certain restrictions.

Validity of X.509 Certificates

X.509 certificates are valid until a specific date. When a system certificate expires, the Cisco ISE functionality that depends on the certificate is impacted. Cisco ISE notifies you about the pending expiration of a system certificate when the expiration date is within 90 days. This notification appears in several ways:

- Colored expiration status icons appear in the **System Certificates** window. The navigation path is **Administration > System > Certificate Management > System Certificates**.
- Expiration messages appear in the Cisco ISE System Diagnostic report. The navigation path is **Operations > Reports > Reports > Diagnostics > System Diagnostic**.
- Expiration alarms are generated 90 days, 60 days, and 30 days before expiration. Expiration alarms are generated every day in the final 30 days before expiration.

If the expiring certificate is a self-signed certificate, you can extend its expiration date by editing the certificate. For a certificate authority-signed certificate, you must allow sufficient time to acquire the replacement certificate from your certificate authority.

Enable Public Key Infrastructure in Cisco ISE

PKI is a cryptographic technique that enables secure communication and verifies the identity of a user using digital signatures.

Step 1 Configure system certificates on each node in your deployment for the following:

- TLS-enabled authentication protocols such as EAP-TLS.
- Administration portal authentication.
- Allow browser and REST clients to access Cisco ISE web portals.
- Allow access to pxGrid controller.

By default, a Cisco ISE node is preinstalled with a self-signed certificate that is used for EAP authentication, and for access to administration portal, end user portals, and pxGrid controller. In a typical enterprise environment, this self-signed certificate is replaced with server certificates that are signed by a trusted CA.

Step 2 Populate the Trusted Certificates store with the CA-signed certificates that are used to establish trust with the user, and device certificates that will be presented to Cisco ISE.

To validate the authenticity of a user or device certificate with a certificate chain that consists of a root CA certificate and one or more intermediate CA certificates:

- Enable the relevant trust option for the root CA.

In the Cisco ISE GUI, choose **Administration > System > Certificates > Certificate Management > Trusted Certificates**. In this window, check the check box for the root CA certificate and click **Edit**. In the **Usage** area, check the necessary check boxes in the **Trusted For** area.

- If you do not want to enable the trust option for the root CA, import the entire CA-signed certificate chain into the Trusted Certificates store.

For inter-node communications, you must populate the Trusted Certificates store with the trust certificates that validate the Admin system certificate of each node in the Cisco ISE deployment. To use the default self-signed certificate for internode communication, export this certificate from the System Certificates window of each Cisco ISE node and import it into the Trusted Certificates store. If you replace the self-signed certificates with CA-signed certificates, it is only necessary to populate the Trusted Certificates store with the appropriate root CA and intermediate CA certificates. You cannot register a node in a Cisco ISE deployment until you complete this step.

If you use self-signed certificates to secure communication between a client and a PSN in a deployment, when BYOD users move from one location to another, EAP-TLS user authentication fails. For such authentication requests that have to be serviced between a few PSNs, you must secure communication between the client and the PSN with an externally-signed CA certificate or use wildcard certificates that are signed by an external CA.

If you intend to get a publicly signed certificate or if the Cisco ISE deployment is to be operated in FIPS mode, you must ensure that all system and trusted certificates are FIPS-compliant. This means that each certificate must have a minimum key size of 2048 bytes, and use SHA-1 or SHA-256 encryption.

Note After you obtain a backup from a standalone Cisco ISE node or the PAN, if you change the certificate configuration on one or more nodes in your deployment, you must obtain another backup to restore data. Otherwise, if you try to restore data using the older backup, communication between the nodes might fail.

Wildcard Certificates

A wildcard certificate uses a wildcard notation (an asterisk and period before the domain name) and the certificate can be shared across multiple hosts in an organization. For example, the CN value for the certificate subject would be a generic hostname such as `aaa.ise.local` and the SAN field would include the same generic hostname and a wildcard notation such as `DNS.1=aaa.ise.local` and `DNS.2=*.ise.local`.

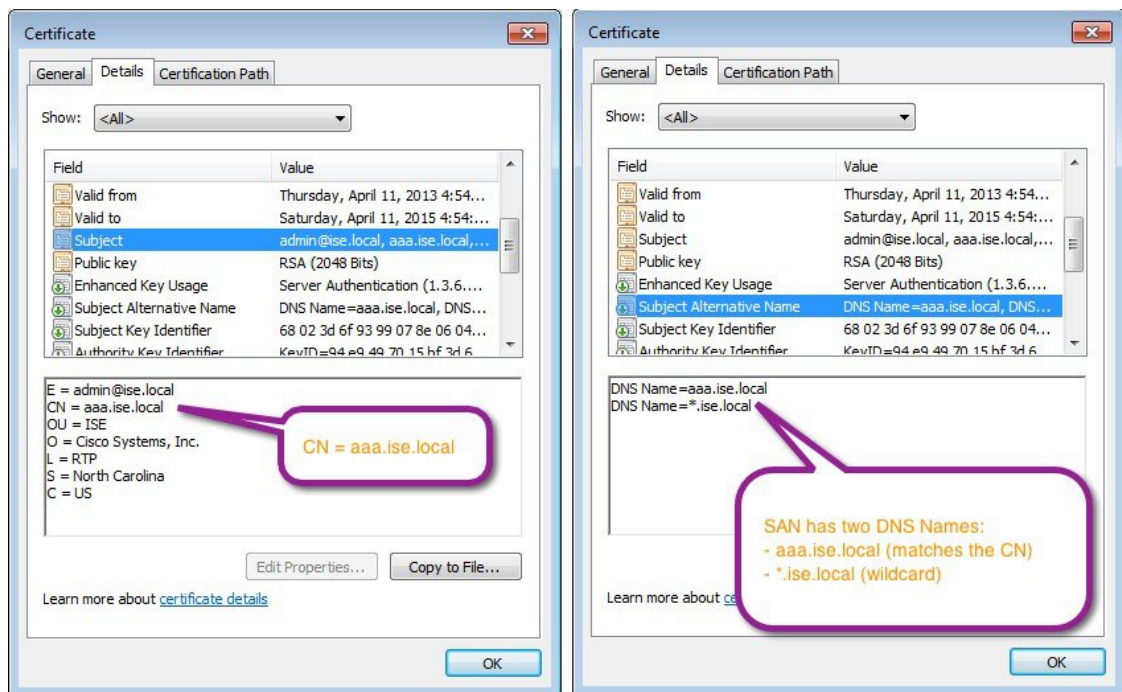
If you configure a wildcard certificate to use `*.ise.local`, you can use the same certificate to secure any other host whose DNS name ends with `“.ise.local,”` such as :

- `aaa.ise.local`
- `psn.ise.local`
- `mydevices.ise.local`
- `sponsor.ise.local`

Wildcard certificates secure communication in the same way as a regular certificate, and requests are processed using the same validation methods.

The following figure is an example of a wildcard certificate that is used to secure a website.

Figure 13: Example of Wildcard Certificate



Wildcard Certificate Support in Cisco ISE

Cisco ISE supports wildcard certificates. In earlier releases, Cisco ISE verified any certificate enabled for HTTPS to ensure the common name field matches the FQDN of the host exactly. If the fields did not match, the certificate could not be used for HTTPS communication.

In earlier releases, Cisco ISE used that common name value to replace the variable in the url-redirect A-V pair string. For all centralized web authentication, onboarding, posture redirection, and so on, the common name value was used.

Cisco ISE uses the hostname of the ISE node as the common name.

Wildcard Certificates for HTTPS and Extensible Authentication Protocol Communication

You can use wildcard server certificates in Cisco ISE for administration (web-based services) and EAP protocols that use SSL or TLS tunneling. When you use wildcard certificates, you do not need to generate a unique certificate for each Cisco ISE node. Also, you no longer have to populate the SAN field with multiple FQDN values to prevent certificate warnings. Use an asterisk (*) in the SAN field to share a single certificate across multiple nodes in a deployment and prevent certificate name mismatch warnings. However, the use of wildcard certificates is considered less secure than assigning a unique server certificate to each Cisco ISE node.

When assigning public wildcard certificates to the guest portal and importing sub-CA with root-CA certificates, the certificate chain is not sent until Cisco ISE services are restarted.



Note If you use wildcard certificates, we recommend that you partition your domain space for greater security. For example, instead of *.example.com, you can partition it as *.amer.example.com. If you do not partition your domain, it could lead to serious security issues.

Wildcard certificates use an asterisk (*) and a period before the domain name. For example, the common name value for a certificate's Subject Name would be a generic hostname such as aaa.ise.local and the SAN field would have the wildcard character such as *.ise.local. Cisco ISE supports wildcard certifications in which the wildcard character (*) is the left-most character in the presented identifier. For example, *.example.com or *.ind.example.com. Cisco ISE does not support certificates in which the presented identifier contains other characters along with the wildcard character. For example, abc*.example.com, or a*b.example.com, or *abc.example.com.

Fully Qualified Domain Name in URL Redirection

Authorization profile redirects are carried out for central web authentication, device registration web authentication, native supplicant provisioning, mobile device management, client provisioning, and posture services. When Cisco ISE builds an authorization profile redirect, the resulting cisco-av-pair includes a string similar to the following:

```
url-redirect=https://ip:port/guestportal/gateway?sessionId=SessionIdValue&action=cwa
```

When processing this request, Cisco ISE substitutes actual values for some keywords in this string. For example, SessionIdValue is replaced with the actual session ID of the request. For an eth0 interface, Cisco ISE replaces the IP in the URL with the FQDN of the Cisco ISE node. For non-eth0 interfaces, Cisco ISE uses the IP address in the URL. You can assign a host alias (name) for interfaces eth1 through eth3, which Cisco ISE can then substitute in place of IP address during URL redirection.

To do this, use the **ip host** command in the configuration mode from the Cisco ISE CLI ISE /admin(config)# prompt:

```
ip host IP_address host-alias FQDN-string
```

Where *IP_address* is the IP address of the network interface (eth1 or eth2 or eth3) and *host-alias* is the name that you assign to the network interface. *FQDN-string* is the fully qualified domain name of the network interface. Using this command, you can assign a *host-alias* or an *FQDN-string* or both to a network interface.

Here is an example using the **ip host** command: `ip host a.b.c.d sales.sales.amerxyz.com`

After you assign a host alias to the non-eth0 interface, restart the application services on Cisco ISE using the **application start ise** command.

Use the **no** form of this command to remove the association of the host alias with the network interface.

no ip host *IP_address host-alias FQDN-string*

Use the **show running-config** command to view the host alias definitions.

If you provide the *FQDN-string*, Cisco ISE replaces the IP address in the URL with the FQDN. If you provide only the host alias, Cisco ISE combines the host alias with the configured IP domain name to form a complete FQDN and replaces the IP address in the URL with the FQDN. If you do not map a network interface to a host alias, then Cisco ISE uses the IP address of the network interface in the URL.

When you use non-eth0 interfaces for client provisioning or native supplicant or guest flows, ensure that the IP address or host alias for non-eth0 interfaces are configured appropriately in the PSN certificate's SAN fields.

Advantages of Using Wildcard Certificates

- Cost savings: Certificates that are signed by third-party CAs are expensive, especially as the number of servers increases. Wildcard certificates can be used on multiple nodes in the Cisco ISE deployment.
- Operational efficiency: Wildcard certificates allow all PSNs to share the same certificate for EAP and web services. In addition to significant cost savings, certificate administration is also simplified by creating the certificate once and applying it on all the PSNs.
- Reduced authentication errors: Wildcard certificates address issues seen with Apple iOS devices when the client stores trusted certificates within the profile and does not follow the iOS keychain where the signing root is trusted. When an iOS client first communicates with a PSN, it does not explicitly trust the PSN certificate, although a trusted CA has signed the certificate. Using a wildcard certificate, the certificate is the same across all PSNs, so the user only has to accept the certificate once and successive authentications to different PSNs proceed without errors or prompts.
- Simplified supplicant configuration: For example, a Microsoft Windows supplicant with PEAP-MSCHAPv2 and a trusted server certificate requires that you specify each of the server certificate to trust, or the user may be prompted to trust each PSN certificate when the client connects using a different PSN. With wildcard certificates, a single server certificate can be trusted rather than individual certificates from each PSN.
- Wildcard certificates result in an improved user experience with less prompting and more seamless connectivity.

Disadvantages of Using Wildcard Certificates

The following are some of the security considerations that are related to the use of wildcard certificates:

- Loss of auditability and nonrepudiation.
- Increased exposure of the private key.

- Not common or understood by administrators.

Wildcard certificates are considered less secure than using a unique server certificate in each Cisco ISE node. But cost and other operational factors outweigh the security risk.

Security devices such as Cisco Adaptive Security Appliance also support wildcard certificates.

You must be careful when deploying wildcard certificates. For example, if you create a certificate with *.company.local and an attacker is able to recover the private key, that attacker can spoof any server in the company.local domain. Therefore, it is considered a best practice to partition the domain space to avoid this type of compromise.

To address this possible issue and to limit the scope of use, wildcard certificates may also be used to secure a specific subdomain of your organization. Add an asterisk (*) in the subdomain area of the common name where you want to specify the wildcard.

For example, if you configure a wildcard certificate for *.ise.company.local, that certificate may be used to secure any host whose DNS name ends in “.ise.company.local”, such as:

- psn.ise.company.local
- mydevices.ise.company.local
- sponsor.ise.company.local

Wildcard Certificate Compatibility

Wildcard certificates are usually created with the wildcard listed as the common name of the certificate subject. Cisco ISE supports this type of construction. However, not all endpoint supplicants support the wildcard character in the certificate subject.

All the Microsoft native supplicants that were tested (including Windows Mobile which is now discontinued) do not support wildcard character in the certificate subject.

You can use another supplicant, such as Cisco AnyConnect Network Access Manager that might allow the use of wildcard characters in the Subject field.

You can also use special wildcard certificates such as DigiCert's Wildcard Plus that is designed to work with incompatible devices by including specific subdomains in the Subject Alternative Name of the certificate.

Although the Microsoft supplicant limitation appears to be a deterrent to using wildcard certificates, there are alternative ways to create the wildcard certificate that allow it to work with all the devices tested for secure access, including the Microsoft native supplicants.

To do this, instead of using the wildcard character in the Subject, you must use the wildcard character in the Subject Alternative Name field instead. The Subject Alternative Name field maintains an extension that is designed for checking the domain name (DNS name). See RFC 6125 and RFC 2128 for more information.

Certificate Hierarchy

In the administration portal, view the certificate hierarchy or the certificate trust chain of all endpoint, system, and trusted certificates. The certificate hierarchy includes the certificate, all the intermediate CA certificates, and the root certificate. For example, when you choose to view a system certificate from the the administration portal, the details of the corresponding system certificate are displayed. The certificate hierarchy is displayed at the top of the certificate. Click a certificate in the hierarchy to view its details. The self-signed certificate does not have any hierarchy or trust chain.

In the certificate listing windows, you will see one of the following icons in the **Status** column:

- Green icon: Indicates a valid certificate (valid trust chain).
- Red icon: Indicates an error (for example, trust certificate missing or expired).
- Yellow icon: Warns that a certificate is about to expire and prompts renewal.

System Certificates

Cisco ISE system certificates are server certificates that identify a Cisco ISE node to other nodes in the deployment and to client applications. System certificates are:

- Used for inter-node communication in a Cisco ISE deployment. Check the **Admin** check box in the **Usage** area of these certificates.
- Used by browser and REST clients who connect to Cisco ISE web portals. Check the **Portal** check box in the **Usage** area of these certificates.
- Used to form the outer TLS tunnel with PEAP and EAP-FAST. Check the **EAP Authentication** check box in the **Usage** area for mutual authentication with EAP-TLS, PEAP, and EAP-FAST.
- Used for RADIUS DTLS server authentication.
- Used to communicate with SAML identity providers. Check the **SAML** check box in the **Usage** area of this certificate. If you choose the SAML option, you cannot use this certificate for any other service.
- Used to communicate with the pxGrid controller. Check the **pxGrid** check box in the **Usage** area of these certificates.

Install valid system certificates on each node in your Cisco ISE deployment. By default, two self-signed certificates and one signed by the internal Cisco ISE CA are created on a Cisco ISE node during installation time:

- A self-signed server certificate designated for EAP, Admin, Portal, and RADIUS DTLS (it has a key size of 2048 and is valid for one year).
- A self-signed SAML server certificate that can be used to secure communication with a SAML identity provider (it has a key size of 2048 and is valid for one year).
- An internal Cisco ISE CA-signed server certificate that can be used to secure communication with pxGrid clients (it has a key size of 4096 and is valid for one year).

When you set up a deployment and register a secondary node, the certificate that is designated for pxGrid controller is automatically replaced with a certificate that is signed by the primary node's CA. Thus, all pxGrid certificates become part of the same PKI trust hierarchy.

**Note**

- When you export a wildcard system certificate to be imported into the other nodes (for inter-node communication), ensure that you export the certificate and the private key, and specify an encryption password. During import, you will need the certificate, private key, and encryption password.
- Cisco ISE supports the use of RSASSA-PSS algorithm only for trusted certificates and endpoint certificates for EAP-TLS authentication. When you view the certificate, the signature algorithm is listed as 1.2.840.113549.1.1.10 instead of the algorithm name.

Cisco ISE does not support system certificates that use RSASSA-PSS as the signature algorithm. This is applicable for the server certificate, root certificate, and intermediate CA certificate.

For supported key and cipher information for your release, see the appropriate version of the [Cisco Identity Services Engine Network Component Compatibility](#) guide.

We recommend that you replace the self-signed certificate with a CA-signed certificate for greater security. To obtain a CA-signed certificate, you must:

1. [Create a Certificate-Signing Request and Submit it to a Certificate Authority, on page 158](#)
2. [Import a Root Certificate to Trusted Certificate Store, on page 156](#)
3. [Bind a CA-Signed Certificate to a Certificate Signing Request, on page 158](#)

ISE Community Resource

[How To: Implement ISE Server-Side Certificates](#)

[Certificate Renewal on Cisco Identity Services Engine Configuration Guide](#)

View System Certificates

The **System Certificate** window lists all the system certificates added to Cisco ISE.

Before you begin

To perform the following task, you must be a Super Admin or System Admin.

Step 1 Choose **Administration > System > Certificates > System Certificates**.

Step 2 The following columns are displayed in the **System Certificates** window:

- **Friendly Name:** Name of the certificate.
- **Usage:** The services for which this certificate is used.
- **Portal group tag:** Applicable only for certificates that are designated for portal use. This field specifies which certificate has to be used for portals.
- **Issued To:** Common Name of the certificate subject.
- **Issued By:** Common Name of the certificate issuer
- **Valid From:** Date on which the certificate was created, also known as the "Not Before" certificate attribute.

- **Valid To (Expiration):** Expiration date of the certificate, also known as the "Not After" certificate attribute. The following icons are displayed next to the expiration date:
 - Green icon: Expiring in more than 90 days.
 - Blue icon: Expiring in 90 days or less.
 - Yellow icon: Expiring in 60 days or less.
 - Orange icon: Expiring in 30 days or less.
 - Red icon: Expired.

Import a System Certificate

You can import a system certificate for any Cisco ISE node from the administration portal.



Note Changing the certificate of the admin role certificate on a primary PAN node restarts services on all other nodes. The system restarts one node at a time, after the primary PAN restart has complete.

Before you begin

- Ensure that you have the system certificate and the private key file on the system that is running on the client browser.
- If the system certificate that you import is signed by an external CA, import the relevant root CA and intermediate CA certificates into the Trusted Certificates store (**Administration > System > Certificates > Trusted Certificates**).
- If the system certificate that you import contains basic constraints extension with the CA flag set to true, ensure that the key usage extension is present, and the keyEncipherment bit or the keyAgreement bit or both are set.
- To perform the following task, you must be a Super Admin or System Admin.

-
- Step 1** Choose **Administration > System > Certificates > System Certificates**.
 - Step 2** Click **Import**.
The **Import Server Certificate** window is displayed.
 - Step 3** Enter the values for the certificate that you are going to import.
 - Step 4** Click **Submit**.
-

Generate a Self-Signed Certificate

Add a new local certificate by generating a self-signed certificate. Cisco recommends that you only employ self-signed certificates for your internal testing and evaluation needs. If you plan to deploy Cisco ISE in a

production environment, use CA-signed certificates whenever possible to ensure more uniform acceptance around a production network.



Note If you use a self-signed certificate and you want to change the hostname of your Cisco ISE node, log in to the administration portal of the Cisco ISE node, delete the self-signed certificate that has the old hostname, and generate a new self-signed certificate. Otherwise, Cisco ISE continues to use the self-signed certificate with the old hostname.

Before you begin

To perform the following task, you must be a Super Admin or System Admin.

Edit a System Certificate

Use this window to edit a system certificate and to renew a self-signed certificate. When you edit a wildcard certificate, the changes are replicated to all the nodes in the deployment. If you delete a wildcard certificate, that wildcard certificate is removed from all the nodes in the deployment.

Before you begin

To perform the following task, you must be a Super Admin or System Admin.

-
- Step 1** Choose **Administration > System > Certificates > System Certificates**.
 - Step 2** Check the check box next to the certificate that you want to edit, and click **Edit**.
 - Step 3** To renew a self-signed certificate, check the **Renewal Period** check box and enter the expiration Time to Live (TTL) in days, weeks, months, or years. Choose the required value from the drop-down lists.
 - Step 4** Click **Save**.
- If the **Admin** check box is checked, then the application server on the Cisco ISE node restarts. In addition, if the Cisco ISE node is the PAN in a deployment, then the application server on all the other nodes in the deployment also restart. The system restarts one node at a time, after the primary PAN restart has completed.
-



Note Using Chrome 65 and above to launch Cisco ISE can cause BYOD portal or Guest portal to fail to launch in the browser although URL is redirected successfully. This is because of a new security feature introduced by Google that requires all certificates to have a Subject Alternative Name field. For Cisco ISE Release 2.4 and later, you must fill the Subject Alternative Name field.

To launch with Chrome 65 and above, follow the steps below:

1. Generate a new self-signed certificate from the Cisco ISE GUI by filling the Subject Alternative Name field. Both DNS and IP Address must be filled.
2. Cisco ISE services restart.
3. Redirect the portal in Chrome browser.
4. From browser View Certificate>Details>Copy the certificate by selecting base-64 encoded.
5. Install the certificate in Trusted path.
6. Close the Chrome browser and try to redirect the portal.



Note When configuring wireless BYOD setup for the browser Firefox 64 and later releases, with operating systems Win RS4 or RS5, you may not be able to add Certificate Exception. This behaviour is expected in case of fresh installs of Firefox 64 and later releases, and does not occur in case of upgrading to Firefox 64 and above from a previous version. The following steps allow you to add certificate exception in this case:

1. Configure for BYOD flow single or dual PEAP or TLS.
2. Configure CP Policy with Windows ALL option.
3. Connect Dot1.x or MAB SSID in end client Windows RS4 or Windows RS5.
4. Type any URL in FF64 browser for redirection to Guest or BYOD portal.
5. Click **Add Exception > Unable to add certificate**, and proceed with flow.

As a workaround, add the certificate manually for Firefox 64. In the Firefox 64 browser, choose **Options > Privacy & Settings > View Certificates > Servers > Add Exception**.

Delete a System Certificate

You can delete the system certificates that you no longer use.

Although you can delete multiple certificates from the System Certificates store at a time, you must have at least one certificate to use for Admin and EAP authentication. Also, you cannot delete any certificate that is in use for Admin, EAP Authentication, Portals, or pxGrid controller. However, you can delete the pxGrid certificate when the service is disabled.

If you choose to delete a wildcard certificate, the certificate is removed from all the Cisco ISE nodes in the deployment.

Step 1 Administration > System > Certificates > System Certificates.

- Step 2** Check the check boxes next to the certificates that you want to delete, and click **Delete**.
A warning message is displayed.
- Step 3** Click **Yes** to delete the certificate.
-

Export a System Certificate

You can export a system certificate or a certificate and its associated private key. If you export a certificate and its private key for backup purposes, you can reimport them later if needed.

Before you begin

To perform the following task, you must be a Super Admin or System Admin.

- Step 1** **Administration > System > Certificates > System Certificates.**
- Step 2** Check the check box next to the certificate that you want to export and click **Export**.
- Step 3** Choose whether to export only the certificate, or the certificate and its associated private key.
- Tip** We do not recommend exporting the private key that is associated with a certificate because its value may be exposed. If you must export a private key (for example, when you export a wildcard system certificate to be imported into the other Cisco ISE nodes for inter-node communication), specify an encryption password for the private key. You must specify this password while importing this certificate into another Cisco ISE node to decrypt the private key.
- Step 4** Enter the password if you have chosen to export the private key. The password should be at least eight characters long.
- Step 5** Click **Export** to save the certificate to the file system that is running your client browser.
- If you export only the certificate, the certificate is stored in the PEM format. If you export both the certificate and private key, the certificate is exported as a .zip file that contains the certificate in the PEM format and the encrypted private key file.
-

Trusted Certificates Store

The Trusted Certificates store contains X.509 certificates that are used for trust and for Simple Certificate Enrollment Protocol (SCEP).

The certificates in the Trusted Certificate store are managed on the primary PAN, and are replicated to every node in the Cisco ISE deployment. Cisco ISE supports wildcard certificates.

Cisco ISE uses the trusted certificates for the following purposes:

- To verify client certificates used for authentication by endpoints, and by Cisco ISE administrators accessing ISE-PICthe administration portal using certificate-based administrator authentication.
- To enable secure communication between Cisco ISE nodes in a deployment. The Trusted Certificates store must contain the chain of CA certificates needed to establish trust with the system certificate on each node in a deployment.

- If a self-signed certificate is used for the system certificate, the self-signed certificate from each node must be placed in the Trusted Certificates store of the PAN.
- If a CA-signed certificate is used for the system certificate, the CA root certificate, and any intermediate certificates in the trust chain, must be placed in the Trusted Certificates store of the PAN.
- To enable Secure LDAP authentication, a certificate from the certificate store must be selected when defining an LDAP identity source that will be accessed over SSL.
- To distribute to personal devices preparing to register in the network using the personal devices portals. Cisco ISE implements the SCEP on PSNs to support personal device registration. A registering device uses the SCEP protocol to request a client certificate from a PSN. The PSN contains a registration authority (RA) that acts as an intermediary. The RA receives and validates the request from the registering device and then forwards the request to an external CA or the internal Cisco ISE CA, which issues the client certificate. The CA sends the certificate back to the RA, which returns it to the device.

Each SCEP CA used by Cisco ISE is defined by a SCEP RA profile. When a SCEP RA profile is created, two certificates are automatically added to the Trusted Certificates store:

- A CA certificate (a self-signed certificate)
- An RA certificate (a Certificate Request Agent certificate), which is signed by the CA.

The SCEP protocol requires that these two certificates be provided by the RA to a registering device. By placing these two certificates in the Trusted Certificates store, they are replicated to all PSN nodes for use by the RA on those nodes.



Note When a SCEP RA profile is removed, the associated CA chain is also removed from the Trusted Certificates store. However, if the same certificates are referenced by secure syslog, LDAP, system, or trust certificates, only the SCEP profile is deleted.



Note

- X.509 certificates imported to Cisco ISE must be in PEM or Distinguished Encoding Rule format. Files containing a certificate chain, a system certificate along with the sequence of trust certificates that sign it, are imported, subject to certain restrictions.
- When assigning public wildcard certificates to the guest portal and importing sub-CA with root-CA certificates, the certificate chain is not sent until the Cisco ISE services restart.

ISE Community Resource

[Install a Third-Party CA Certificate in ISE 2.0](#)

Certificates in Trusted Certificates Store

The Trusted Certificate store is prepopulated with trusted certificates: manufacturing certificate, root certificate, and other trusted certificates. The Root certificate (Cisco Root CA) signs the Manufacturing (Cisco CA

Manufacturing) certificate. These certificates are disabled by default. If you have Cisco IP phones as endpoints in your deployment, enable the root and manufacturing certificates so the Cisco-signed client certificates for the phones are authenticated.

Trusted Certificate Naming Constraints

A trusted certificate in CTL may contain a name constraint extension. This extension defines a namespace for values of all subject name and subject alternative name fields of subsequent certificates in a certificate chain. Cisco ISE does not check constraints that are specified in a root certificate.

Cisco ISE supports the following name constraints:

- Directory name

The directory name constraint should be a prefix of the directory name in the subject or subject alternative name field. For example:

- Correct subject prefix:

CA certificate name constraint: Permitted: O=Cisco

Client certificate subject: O=Cisco,CN=Salomon

- Incorrect subject prefix:

CA certificate name constraint: Permitted: O=Cisco

Client certificate subject: CN=Salomon,O=Cisco

- DNS
- Email
- URI (The URI constraint must start with a URI prefix such as http://, https://, ftp://, or ldap://).

Cisco ISE does not support the following name constraints:

- IP Address
- OtherName

When a trusted certificate contains a constraint that is not supported and the certificate that is being verified does not contain the appropriate field, Cisco ISE rejects the certificate because it cannot verify unsupported constraints.

The following is an example of the name constraints definition within the trusted certificate:

```
X509v3 Name Constraints: critical
    Permitted:
      othername:<unsupported>
      email:.abcde.at
      email:.abcde.be
      email:.abcde.bg
      email:.abcde.by
      DNS:.dir
      DirName: DC = dir, DC = emea
      DirName: C = AT, ST = EMEA, L = AT, O = ABCDE Group, OU = Domestic
      DirName: C = BG, ST = EMEA, L = BG, O = ABCDE Group, OU = Domestic
      DirName: C = BE, ST = EMEA, L = BN, O = ABCDE Group, OU = Domestic
      DirName: C = CH, ST = EMEA, L = CH, O = ABCDE Group, OU = Service Z100
```

```

URI:.dir
IP:172.23.0.171/255.255.255.255
Excluded:
DNS:.dir
URI:.dir

```

An acceptable client certificate subject that matches the above definition is as follows:

```

Subject: DC=dir, DC=emea, OU=+DE, OU=OU-Administration, OU=Users, OU=X1,
CN=cwinwell

```

View Trusted Certificates

The **Trusted Certificates** window lists all the trusted certificates that are available in Cisco ISE. To view the trusted certificates, you must be a Super Admin or System Admin.

Before you begin

To perform the following task, you must be a Super Admin or System Admin.

-
- Step 1** To view all the certificates, choose **Administration > System > Certificates > Trusted Certificates**. The Trusted Certificates window displayed, listing all the trusted certificates.
- Step 2** Check the check box of the trusted certificate and click **Edit**, **View**, **Export**, or **Delete** to perform the required task.
-

Change the Status of a Certificate in Trusted Certificates Store

The status of a certificate must be enabled so that Cisco ISE can use the certificate for establishing trust. When a certificate is imported into the Trusted Certificates store, it is automatically enabled.

Add a Certificate to Trusted Certificates Store

The **Trusted Certificate** store window allows you to add CA certificates to Cisco ISE.

Before you begin

- To perform the following task, you must be a Super Admin or System Admin.
- The certificate that you want to add must be in the file system of the computer where your browser is running. The certificate must be in PEM or DER format.
- To use the certificate for Admin or EAP authentication, define the basic constraints in the certificate and set the CA flag to true.

Edit a Trusted Certificate

After you add a certificate to the Trusted Certificates store, you can further edit it by using the **Edit** options.

Before you begin

To perform the following task, you must be a Super Admin or System Admin.

-
- Step 1** Administration > System > Certificates > Trusted Certificates.
- Step 2** Check the check box next to the certificate that you want to edit, and click **Edit**.
- Step 3** (Optional) Enter a name for the certificate in the **Friendly Name** field. If you do not specify a friendly name, a default name is generated in the following format:
- common-name#issuer#nnnnn*
- Step 4** Define the usage of the certificate by checking the necessary check boxes in the **Trusted For** area.
- Step 5** (Optional) Enter a description for the certificate in the **Description** field.
- Step 6** Click **Save**.
-

Delete a Trusted Certificate

You can delete trusted certificates that you no longer need. However, you must not delete Cisco ISE internal CA certificates. Cisco ISE internal CA certificates can be deleted only when you replace the Cisco ISE root certificate chain for the entire deployment.

- Step 1** Choose **Administration > System > Certificates > Trusted Certificates**.
- Step 2** Check the check boxes next to the certificates that you want to delete, and click **Delete**.
- A warning message is displayed. To delete the Cisco ISE Internal CA certificates, click one of the following options:
- **Delete**: To delete the Cisco ISE internal CA certificates. All endpoint certificates that are signed by the Cisco ISE internal CA become invalid and the endpoints cannot join the network. To allow the endpoints on the network again, import the same Cisco ISE internal CA certificates into the Trusted Certificates store.
 - **Delete & Revoke**: Deletes and revokes the Cisco ISE internal CA certificates. All endpoint certificates that are signed by the Cisco ISE internal CA become invalid and the endpoints cannot get on to the network. This operation cannot be undone. You must replace the Cisco ISE root certificate chain for the entire deployment.
- Step 3** Click **Yes** to delete the certificate.
-

Export a Certificate from Trusted Certificates Store

Before you begin

To perform the following task, you must be a Super Admin or System Admin.



Note If you export certificates from the internal CA and plan to use the exported certificates to restore from backup, use the CLI command **application configure ise**. See [Export Cisco ISE CA Certificates and Keys, on page 173](#).

- Step 1** Choose **Administration > System > Certificates > Trusted Certificates**.

- Step 2** Check the check box next to the certificate that you want to export, and click **Export**. You can export only one certificate at a time.
- Step 3** Save the PEM file to the file system that is running your client browser.

Import a Root Certificate to Trusted Certificate Store

While importing the root CA and intermediate CA certificates, specify the services for which the trusted CA certificates are to be used.

Before you begin

You must have the root certificate and other intermediate certificates from the CA that signed your certificate signing requests and returned the digitally signed CA certificates.

- Step 1** Choose **Administration > System > Certificates > Trusted Certificates**.
- Step 2** Click **Import**.
- Step 3** In the **Import a new Certificate into the Certificate Store** window that is displayed, click **Choose File** to select the root CA certificate signed and returned by your CA.
- Step 4** Enter a **Friendly Name**.
If you do not enter a **Friendly Name**, Cisco ISE autopopulates this field with a name of the format *common-name#issuer#nnnnn*, where *nnnnn* is a unique number. You can also edit the certificate at a later time to change the **Friendly Name**.
- Step 5** Check the check boxes next to the services for which you want to use this trusted certificate.
- Step 6** (Optional) In the **Description** field, enter a description for your certificate.
- Step 7** Click **Submit**.

What to do next

Import the intermediate CA certificates into the Trusted Certificates store (if applicable).

Trusted Certificate Import Settings

Table 7: Trusted Certificate Import Settings

Field Name	Description
Certificate File	Click Browse to choose the certificate file from the computer that is running the browser.
Friendly Name	Enter a friendly name for the certificate. If you do not specify a name, Cisco ISE automatically creates a name in the format <common name>#<issuer>#<nnnnn>, where <nnnnn> is a unique five-digit number.

Field Name	Description
Trust for authentication within ISE	Check the check box if you want this certificate to be used to verify server certificates (from other ISE nodes or LDAP servers).
Trust for client authentication and Syslog	(Applicable only if you check the Trust for authentication within ISE check box) Check the check box if you want this certificate to be used to: <ul style="list-style-type: none"> • Authenticate endpoints that connect to ISE using the EAP protocol • Trust a Syslog server
Trust for authentication of Cisco Services	Check this check box if you want this certificate to be used to trust external Cisco services such as the feed service.
Validate Certificate Extensions	(Only if you check both the Trust for client authentication and Enable Validation of Certificate Extensions options) Ensure that the “keyUsage” extension is present and the “keyCertSign” bit is set, and that the basic constraints extension is present with the CA flag set to true.
Description	Enter an optional description.

Related Topics

[Trusted Certificates Store](#), on page 151

[Certificate Chain Import](#), on page 157

[Import a Root Certificate to Trusted Certificate Store](#), on page 156

Certificate Chain Import

You can import multiple certificates from a single file that contains a certificate chain received from a Certificate store. All certificates in the file must be in the PEM format, and the certificates must be arranged in the following order:

- The last certificate in the file must be the client or server certificate issued by the CA.
- All preceding certificates must be the root CA certificate plus any intermediate CA certificates in the signing chain for the issued certificate.

Importing a certificate chain is a two-step process:

1. Import the certificate chain file into the Trusted Certificate store in the Cisco ISE administration portal. This operation imports all certificates from the file except the last one into the Trusted Certificates store.
2. Import the certificate chain file using the Bind a CA-Signed Certificate operation. This operation imports the last certificate from the file as a local certificate.

Certificate-Signing Requests

For a CA to issue a signed certificate, you must create a certificate signing request and submit it to the CA.

The list of certificate-signing requests that you have created is available in the **Certificate-Signing Requests** window. Choose **Administration > System > Certificates > Certificate-Signing Requests**. To obtain signatures from a CA, you must export the certificate-signing request and then send the certificates to the CA. The CA signs and returns your certificates.

You can manage the certificates centrally from the Cisco ISE administration portal. You can create certificate-signing requests for all the nodes in your deployment and export them. Then, you should submit the certificate-signing requests to a CA, obtain the signed certificates from the CA, import the root and intermediary CA certificates given by the CA into the Trusted Certificates store, and bind the CA-signed certificates to the certificate-signing requests.

Create a Certificate-Signing Request and Submit it to a Certificate Authority

You can generate a certificate-signing request to obtain a CA-signed certificate for the nodes in your deployment. You can generate the certificate-signing request for a specific node in the deployment or for all the nodes in your deployment.

-
- Step 1** Choose **Administration > System > Certificates > Certificate-Signing Requests**.
 - Step 2** Click **Generate Certificate-Signing Requests (CSR)** to generate the certificate-signing request.
 - Step 3** Enter the values for generating a certificate-signing request. See [Trusted Certificate Settings, on page 962](#) for information on each of the fields in the window displayed.
 - Step 4** (Optional) Check the check box of the signing request that you want to download and click **Export** to download the request.
 - Step 5** Copy all the text from “-----BEGIN CERTIFICATE REQUEST-----” through “-----END CERTIFICATE REQUEST-----.” and paste the contents of the request in the certificate request of the chosen CA.
 - Step 6** Download the signed certificate.

Some CAs might email the signed certificate to you. The signed certificate is in the form of a .zip file that contains the newly issued certificate and the public signing certificates of the CA that you must add to the Cisco ISE trusted certificates store. The digitally-signed CA certificate, root CA certificate, and other intermediate CA certificate (if applicable) can be downloaded to the local system running your client browser.

Bind a CA-Signed Certificate to a Certificate Signing Request

After the CA returns the digitally signed certificate, you must bind it to the certificate-signing request. You can perform the bind operation for all the nodes in your deployment, from the Cisco ISE administration portal.

Before you begin

- You must have the digitally signed certificate, and the relevant root intermediate CA certificates sent by the CA.
- Import the relevant root and intermediate CA certificates to the Trusted Certificates store (**Administration > System > Certificates > Trusted Certificates**).

-
- Step 1** Choose **Administration > System > Certificates > Certificate-Signing Requests**.
- Step 2** Check the check box next to the certificate signing request you must bind with the CA-signed certificate.
- Step 3** Click **Bind**.
- Step 4** In the **Bind CA Signed Certificate** window displayed, click **Browse** to choose the CA-signed certificate.
- Step 5** Enter a value in the **Friendly Name** field.
- Step 6** Check the **Validate Certificate Extensions** check box if you want Cisco ISE to validate certificate extensions.
- If you enable the **Validate Certificate Extensions** option, and the certificate that you import contains a basic constraints extension with the CA flag set to True, ensure that the key usage extension is present, and that the keyEncipherment bit or the keyAgreement bit, or both, are also set.
- Note** Cisco ISE requires EAP-TLS client certificates to have digital signature key usage extension.
- Step 7** (Optional) Check the services for which this certificate will be used in the **Usage** area.
- This information is autopopulated if you have enabled the **Usage** option while generating the certificate signing request. If you do not want to specify the usage at the time of binding the certificate, uncheck the **Usage** option. You can also choose to edit the certificate at a later time to specify the usage.
- Changing the **Admin** usage certificate on a primary PAN restarts the services on all the other nodes. The system restarts one node at a time, after the primary PAN restarts.
- Step 8** Click **Submit** to bind the certificate-signing request with the CA-signed certificate.
- If this certificate is marked for Cisco ISE internode communication usage, the application server on the Cisco ISE node restarts.
- Repeat this process to bind the certificate-signing request with the CA-signed certificate on the other nodes in the deployment.
-

What to do next

[Import a Root Certificate to Trusted Certificate Store, on page 156](#)

Export a Certificate-Signing Request

Before you begin

To perform the following task, you must be a Super Admin or System Admin.

-
- Step 1** Choose **Administration > System > Certificates > Certificate-Signing Requests**.
- Step 2** Check the check box next to the certificates that you want to export, and click **Export**.
- Step 3** Click **OK** to save the file to the file system that is running the client browser.
- Step 4** The certificate-signing request is downloaded to your local file system.
-

Set Up Certificates for Portal Use

With multiple PSNs in a deployment that can service a web portal request, Cisco ISE needs a unique identifier to identify the certificate that must be used for portal communication. When you add or import certificates that are designated for portal use, define a certificate group tag and associate it with the corresponding certificate on each node in your deployment. Associate this certificate group tag to the corresponding end-user portals (guest, sponsor, and personal devices portals). This certificate group tag is the unique identifier that helps Cisco ISE identify the certificate that must be used when communicating with each of these portals. You can only designate one certificate from each node for each of the portals.



Note Cisco ISE presents the Portal certificate on TCP port 8443 (or the port that you have configured for portal use).

Step 1 [Create a Certificate-Signing Request and Submit it to a Certificate Authority, on page 158.](#)

You must choose a Certificate Group Tag that you have already defined or create a new one for the portal. For example, mydevicesportal.

Step 2 [Import a Root Certificate to Trusted Certificate Store, on page 156.](#)

Step 3 [Bind a CA-Signed Certificate to a Certificate Signing Request, on page 158.](#)

Reassign Default Portal Certificate Group Tag to CA-Signed Certificate

By default, all Cisco ISE portals use the self-signed certificate. If you want to use a CA-signed certificate for portals, you can assign the default portal certificate group tag to a CA-signed certificate. You can use an existing CA-signed certificate or generate a CSR and obtain a new CA-signed certificate for portal use. You can reassign any portal group tag from one certificate to another.



Note When you edit an existing certificate, if the portal tag (guest) that is associated with the certificate is already in use by any of the portals, then you cannot reassign the default portal certificate group tag or any other portal group tag to this certificate. The system displays the list of portals that use the "guest" portal tag.

The following procedure describes how to reassign the default portal certificate group tag to a CA-signed certificate.

Step 1 Choose **Administration > System > Certificates > System Certificates**.

Hover the mouse over the **i** icon next to the Default Portal Certificate Group tag to view the list of portals that use this tag. You can also view the ISE nodes in the deployment that have portal certificates which are assigned this tag.

Step 2 Check the check box next to the CA-signed certificate that you want to use for portals, and click **Edit**.

Be sure to choose a CA-signed certificate that is not in use by any of the portals.

Step 3 Under the **Usage** area, check the **Portal** check box and choose the Default Portal Certificate Group Tag.

Step 4 Click **Save**.

A warning message appears.

Step 5 Click **Yes** to reassign the default portal certificate group tag to the CA-signed certificate.

Associate Portal Certificate Tag Before You Register a Node

If you use the "Default Portal Certificate Group" tag for all the portals in your deployment, before you register a new ISE node, ensure that you import the relevant CA-signed certificate, choose "Portal" as a service, and associate the "Default Portal Certificate Group" tag with this certificate.

When you add a new node to a deployment, the default self-signed certificate is associated with the "Default Portal Certificate Group" tag and the portals are configured to use this tag.

After you register a new node, you cannot change the Certificate Group tag association. Therefore, before you register the node to the deployment, you must do the following:

Step 1 Create a self-signed certificate, choose "Portal" as a service, and assign a different certificate group tag (for example, tempportaltag).

Step 2 Change the portal configuration to use the newly created certificate group tag (tempportaltag).

Step 3 Edit the default self-signed certificate and remove the Portal role.

This option removes the Default Portal Certificate Group tag association with the default self-signed certificate.

Step 4 Do one of the following:

Option	Description
Generate a CSR	<p>When you generate the CSR:</p> <ol style="list-style-type: none"> a. Choose "Portal" as a service for which you will use this certificate and associate the "Default Portal Certificate Group" tag. b. Send the CSR to a CA and obtain the signed certificate. c. Import the root and any other intermediate certificates of the CA that signed your certificate in to the Trusted Certificates store. d. Bind the CA-signed certificate with the CSR.
Import the private key and the CA-signed certificate	<p>When you import the CA-signed certificate:</p> <ol style="list-style-type: none"> a. Choose "Portal" as a service for which you will use this certificate and associate the "Default Portal Certificate Group" tag. b. Import the root and any other intermediate certificates of the CA that signed your certificate in to the Trusted Certificates store.
Edit an existing CA-signed certificate.	<p>When you edit the existing CA-signed certificate:</p> <p>Choose "Portal" as a service for which you will use this certificate and associate the "Default Portal Certificate Group" tag.</p>

- Step 5** Register the ISE node to the deployment.
The portal configuration in the deployment is configured to the "Default Portal Certificate Group" tag and the portals are configured to use the CA-signed certificate associated with the "Default Portal Certificate Group" tag on the new node.
-

User and Endpoint Certificate Renewal

By default, Cisco ISE rejects a request that comes from a device whose certificate has expired. However, you can change this default behavior and configure ISE to process such requests and prompt the user to renew the certificate.

If you choose to allow the user to renew the certificate, Cisco recommends that you configure an authorization policy rule which checks if the certificate has been renewed before processing the request any further. Processing a request from a device whose certificate has expired may pose a potential security threat. Hence, you must configure appropriate authorization profiles and rules to ensure that your organization's security is not compromised.

Some devices allow you to renew the certificates before and after their expiry. But on Windows devices, you can renew the certificates only before it expires. Apple iOS, Mac OSX, and Android devices allow you to renew the certificates before or after their expiry.

Dictionary Attributes Used in Policy Conditions for Certificate Renewal

Cisco ISE certificate dictionary contains the following attributes that are used in policy conditions to allow a user to renew the certificate:

- **Days to Expiry:** This attribute provides the number of days for which the certificate is valid. You can use this attribute to create a condition that can be used in authorization policy. This attribute can take a value from 0 to 15. A value of 0 indicates that the certificate has already expired. A value of 1 indicates that the certificate has less than 1 day before it expires.
- **Is Expired:** This Boolean attribute indicates whether a certificate has expired or not. If you want to allow certificate renewal only when the certificate is near expiry and not after it has expired, use this attribute in authorization policy condition.

Authorization Policy Condition for Certificate Renewal

You can use the CertRenewalRequired simple condition (available by default) in authorization policy to ensure that a certificate (expired or about to expire) is renewed before Cisco ISE processes the request further.

CWA Redirect to a Renew Certificate

If a user certificate is revoked before its expiry, Cisco ISE checks the CRL published by the CA and rejects the authentication request. In case, if a revoked certificate has expired, the CA may not publish this certificate in its CRL. In this scenario, it is possible for Cisco ISE to renew a certificate that has been revoked. To avoid this, before you renew a certificate, ensure that the request gets redirected to Central Web Authentication (CWA) for a full authentication. You must create an authorization profile to redirect the user for CWA.

Configure Cisco ISE to Allow Users to a Renew Certificate

You must complete the tasks listed in this procedure to configure Cisco ISE to allow users to renew certificates.

Before you begin

Configure a limited access ACL on the WLC to redirect a CWA request.

-
- Step 1** [Update the Allowed Protocol Configuration, on page 163](#)
 - Step 2** [Create an Authorization Policy Profile for CWA Redirection, on page 163](#)
 - Step 3** [Create an Authorization Policy Rule to Renew a Certificate, on page 164](#)
 - Step 4** [Enable BYOD Settings in Guest Portal, on page 164](#)
-

Update the Allowed Protocol Configuration

-
- Step 1** Choose **Policy > Policy Elements > Results > Authentication > Allowed Protocols > Default Network Access**.
 - Step 2** Check the **Allow Authentication of expired certificates to allow certificate renewal in Authorization Policy** check box under the EAP-TLS protocol and EAP-TLS inner methods for PEAP and EAP-FAST protocols.

Requests that use the EAP-TLS protocol will go through the NSP flow.

For PEAP and EAP-FAST protocols, you must manually configure Cisco AnyConnect for Cisco ISE to process the request.
 - Step 3** Click **Submit**.
-

What to do next

[Create an Authorization Policy Profile for CWA Redirection, on page 163](#)

Create an Authorization Policy Profile for CWA Redirection

Before you begin

Ensure that you have configured a limited access ACL on the WLC.

-
- Step 1** Choose **Policy > Policy Elements > Results > Authorization > Authorization Profiles**.
 - Step 2** Click **Add**.
 - Step 3** Enter a name for the authorization profile. For example, CertRenewal_CWA.
 - Step 4** Check the **Web Redirection (CWA, DRW, MDM, NSP, CPP)** check box in the Common Tasks area.
 - Step 5** Choose **Centralized Web Auth** from the drop-down list and the limited access ACL.
 - Step 6** Check the **Display Certificates Renewal Message** check box.

The URL-redirect attribute value changes and includes the number of days for which the certificate is valid.
 - Step 7** Click **Submit**.
-



Note If you have configured the following Device Registration WebAuth (DRW) policies for wireless devices in Cisco ISE 1.2:

- DRW-Redirect policy with Condition = (Wireless_MAB AND Network Access:UseCase EQUALS HostLookup) and Profile = Wireless-drw-redirect
- DRW-Allow policy with Condition = (Wireless_MAB AND Network Access:UseCase EQUALS HostLookup) and Profile = Wireless-Permit

After upgrading to ISE 1.3 or above version, you must update the DRW-Allow policy condition as follows:

- Condition = (Wireless_MAB AND Network Access:UseCase EQUALS Guest Flow) and Profile = Wireless-Permit

What to do next

[Create an Authorization Policy Rule to Renew a Certificate, on page 164](#)

Create an Authorization Policy Rule to Renew a Certificate

Before you begin

Ensure that you have created an authorization profile for central web authentication redirection.

Enable Policy Sets on **Administration > System > Settings > Policy Settings**.

Step 1 Choose **Work Centers > Device Administration > Policy Sets**.

Step 2 Click **Create Above**.

Step 3 Enter a name for the new rule.

Step 4 Choose the following simple condition and result:

If CertRenewalRequired EQUALS True, then choose the authorization profile that you created earlier (CertRenewal_CWA) for the permission.

Step 5 Click **Save**.

What to do next

When you access the corporate network with a device whose certificate has expired, click **Renew** to reconfigure your device.

Enable BYOD Settings in Guest Portal

For a user to be able to renew a personal device certificate, you must enable the BYOD settings in the chosen guest portal.

Step 1 Choose **Work Centers > Guest Access > Portals & Components > Guest Portals**.

- a) Select the chosen CWA portal and click **Edit**.

Step 2 From BYOD Settings, check the **Allow employees to use personal devices on the network** check box.

Step 3 Click **Save**.

Certificate Renewal Fails for Apple iOS Devices

When you use ISE to renew the endpoint certificates on Apple iOS devices, you might see a “Profiled Failed to Install” error message. This error message appears if the expiring or expired network profiles were signed by a different Admin HTTPS certificate than the one that is used in processing the renewal, either on the same Policy Service Node (PSN) or on another PSN.

As a workaround, use a multi-domain SSL certificate, which is commonly referred to as Unified Communications Certificate (UCC), or a wildcard certificate for Admin HTTPS on all PSNs in the deployment.

Cisco ISE CA Service

Certificates can be self-signed or digitally signed by an external Certificate Authority (CA). The Cisco ISE Internal Certificate Authority (ISE CA) issues and manages digital certificates for endpoints from a centralized console to allow employees to use their personal devices on the company's network. A CA-signed digital certificate is considered industry standard and more secure. The Primary PAN is the Root CA. The Policy Service Nodes (PSNs) are subordinate CAs to the Primary PAN (SCEP RA). The ISE CA offers the following functionalities:

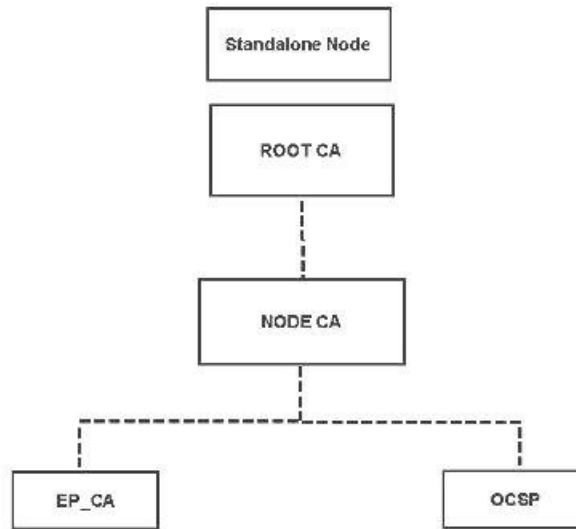
- **Certificate Issuance:** Validates and signs Certificate Signing Requests (CSRs) for endpoints that connect to your network.
- **Key Management:** Generates and securely stores keys and certificates on both PAN and PSN nodes.
- **Certificate Storage:** Stores certificates issued to users and devices.
- **Online Certificate Status Protocol (OCSP) Support:** Provides an OCSP responder to check for the validity of certificates.

When a CA Service is disabled on the primary administrative node, the CA service is still seen as running on the secondary administration node's CLI. Ideally, the CA service should be seen as disabled. This is a known Cisco ISE issue.

Cisco ISE CA Certificates Provisioned on Administration and Policy Service Nodes

After installation, a Cisco ISE node is provisioned with a Root CA certificate, and a Node CA certificate to manage certificates for endpoints.

Figure 14: Cisco ISE CA Certificates Provisioned on a Standalone Node

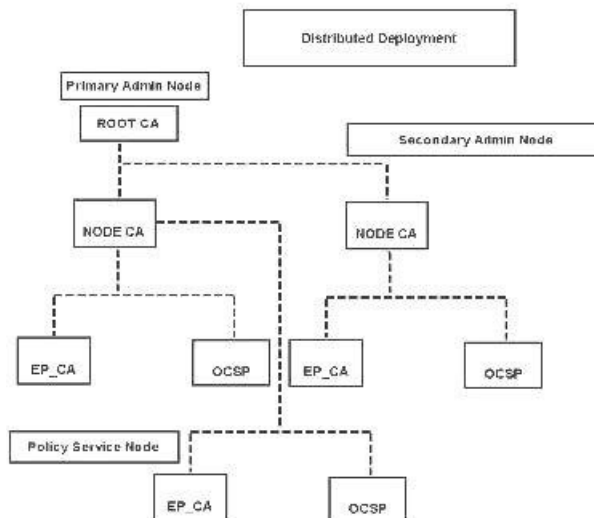


When you set up a deployment, the node that you designate as the Primary Administration Node (PAN) becomes the Root CA. The PAN has a Root CA certificate and a Node CA certificate that is signed by the Root CA.

When you register a Secondary Administration Node to the PAN, a Node CA certificate is generated and is signed by the Root CA on the Primary Administration Node.

Any Policy Service Node (PSN) that you register with the PAN is provisioned an Endpoint CA and an OCSP certificate signed by the Node CA of the PAN. The Policy Service Nodes (PSNs) are subordinate CAs to the PAN. When you use the ISE CA, the Endpoint CA on the PSN issues the certificates to the endpoints that access your network.

Figure 15: Cisco ISE CA Certificates Provisioned on Administration and Policy Service Nodes in a Deployment



Cisco ISE CA Chain Regeneration

When you regenerate the Cisco ISE CA chain, all the certificates including the Root CA, Node CA, and Endpoint CA certificates are regenerated. You must regenerate the ISE CA chain when you change the domain name or hostname of your PAN or PSN. When you upgrade from earlier releases to Release 2.0 or later, we recommend that you regenerate the ISE CA chain to move from the two root hierarchy to a single root hierarchy.

Elliptical Curve Cryptography Certificates Support

Cisco ISE CA service supports certificates that are based on Elliptical Curve Cryptography (ECC) algorithms. ECC offers more security and better performance than other cryptographic algorithms even when using a much smaller key size.

The following table compares the key sizes of ECC and RSA and security strength.

ECC Key Size (in bits)	RSA Key Size (in bits)
160	1024
224	2048
256	3072
384	7680
521	15360

Because of the smaller key size, encryption is quicker.

Cisco ISE supports the following ECC curve types. The higher the curve type or key size, the greater is the security.

- P-192
- P-256
- P-384
- P-521

ISE does not support explicit parameters in the EC part of a certificate. If you try to import a certificate with explicit parameters, you get the error: Validation of certificate failed: Only named ECParameters supported.

Cisco ISE CA service supports ECC certificates for devices connecting through the BYOD flow. You can also generate ECC certificates from the Certificate Provisioning Portal.



Note The following table lists the operating systems and versions that support ECC along with the supported curve types. If your devices are not running a supported operating system or on a supported version, you can use RSA-based certificates instead.

Operating System	Supported Versions	Supported Curve Types
Windows	8 and later	P-256, P-384, and P-521
Android	4.4 and later Note Android 6.0 requires May 2016 patch to support ECC certificates.	All curve types (except Android 6.0, which does not support the P-192 curve type).

Windows 7 and Apple iOS do not natively support ECC for authentication over EAP-TLS. This release of Cisco ISE does not support the use of ECC certificates on MAC OS X devices.

If the BYOD flow with Enrollment over Secure Transport (EST) protocol is not working properly, check the following:

- Certificate Services Endpoint Sub CA certificate chain is complete. To check whether the certificate chain is complete:
 1. Choose **Administration > System > Certificates > Certificate Authority > Certificate Authority Certificates**.
 2. Check the check box next to the certificate that you want to check and click **View**.
- Ensure that the CA and EST services are up and running. If the services are not running, go to **Administration > System > Certificates > Certificate Authority > Internal CA Settings** to enable the CA service.
- If you have upgraded to Cisco ISE 2.x from an ISE version prior to 2.0, replace the ISE Root CA certificate chain after the upgrade. To do this:
 1. Choose **Administration > System > Certificates > Certificate Management > Certificate Signing Requests**.
 2. Click **Generate Certificate Signing Requests (CSR)**.
 3. Choose ISE Root CA from one or more Certificates **will be used for** drop-down list.
 4. Click **Replace ISE Root CA Certificate Chain**.



Note This release of Cisco ISE does not support EST clients to authenticate directly against the EST Server residing within Cisco ISE.

While on-boarding an Android or a Windows endpoint, ISE triggers an EST flow if the request is for an ECC-based certificate.

Cisco ISE Certificate Authority Certificates

The Certificate Authority (CA) Certificates page lists all the certificates related to the internal Cisco ISE CA. In previous releases, these CA certificates were present in the Trusted Certificates store and are now moved to the CA Certificates page. These certificates are listed node wise in this page. You can expand a node to view all the ISE CA certificates of that particular node. The Primary and Secondary Administration nodes have the root CA, node CA, subordinate CA, and OCSP responder certificates. The other nodes in the deployment have the endpoint subordinate CA and OCSP certificates.

When you enable the Cisco ISE CA service, these certificates are generated and installed on all the nodes automatically. Also, when you replace the entire ISE Root CA Chain, these certificates are regenerated and installed on all the nodes automatically. There is no manual intervention required.

The Cisco ISE CA certificates follow the following naming convention: **Certificate Services <Endpoint Sub CA/Node CA/Root CA/OCSP Responder>-<node_hostname>#certificate_number**.

From the CA Certificates page, you can edit, import, export, delete, and view the Cisco ISE CA certificates.

Edit a Cisco ISE CA Certificate

After you add a certificate to the Cisco ISE CA Certificates Store, you can further edit it by using the edit settings.

Before you begin

To perform the following task, you must be a Super Admin or System Admin.

-
- Step 1** Choose **Administration > System > Certificates > Certificate Authority > Certificate Authority Certificates**.
 - Step 2** In the ISE-PIC GUI, click the **Menu** icon (☰) and choose .
 - Step 3** Check the check box next to the certificate that you want to edit, and click **Edit**.
 - Step 4** Modify the editable fields as required. See [Trusted Certificate Settings, on page 962](#) for a description of the fields.
 - Step 5** Click **Save** to save the changes you have made to the certificate store.
-

Export a Cisco ISE CA Certificate

To export the Cisco ISE root CA and node CA certificates:

Before you begin

To perform the following task, you must be a Super Admin or System Admin.

-
- Step 1** Choose **Administration > System > Certificates > Certificate Authority > Certificate Authority Certificates**.
 - Step 2** In the ISE-PIC GUI, click the **Menu** icon (☰) and choose .
 - Step 3** Check the check box next to the certificate that you want to export, and click **Export**. You can export only one certificate at a time.
 - Step 4** Save the privacy-enhanced mail file to the file system that is running your client browser.
-

Import a Cisco ISE CA Certificate

If an endpoint tries to authenticate to your network using a certificate issued by Cisco ISE CA from another deployment, you must import the Cisco ISE root CA, node CA, and endpoint sub CA certificates from that deployment in to the Cisco ISE Trusted Certificates store.

Before you begin

- To perform the following task, you must be a Super Admin or System Admin.
- Export the ISE root CA, node CA, and endpoint sub CA certificates from the deployment where the endpoint certificate is signed and store it on the file system of the computer where your browser is running.

-
- Step 1** Log in to the Admin Portal of the deployment where the endpoint is getting authenticated.
- Step 2** Choose **Administration > System > Certificates > Trusted Certificates**.
- Step 3** Click **Import**.
- Step 4** Configure the field values as necessary. See [Trusted Certificate Import Settings, on page 156](#) for more information.

If client certificate-based authentication is enabled, then Cisco ISE will restart the application server on each node in your deployment, starting with the application server on the PAN and followed, one-by-one, by each additional node.

Certificate Templates

Certificate templates contain properties that are common to all certificates issued by the Certificate Authority (CA) based on that template. The certificate template defines the Subject, Subject Alternative Name (SAN), key type, key size, SCEP RA profile that must be used, validity period of the certificate, and the extended key usage (EKU) that specifies whether the certificate has to be used for client or server authentication or both. The internal Cisco ISE CA (ISE CA) uses a certificate template to issue certificates based on that template.

Cisco ISE comes with the following default certificate templates for the ISE CA. You can create additional certificate templates, if needed. The default certificate templates are:

- **CA_SERVICE_Certificate_Template**—For other network services that use Cisco ISE as the Certificate Authority. For example, use this certificate template while configuring ISE to issue certificates for ASA VPN users. You can modify only the validity period in this certificate template.
- **EAP_Authentication_Certificate_Template**—For EAP authentication.
- **pxGrid_Certificate_Template**—For the pxGrid controller while generating the certificate from the Certificate Provisioning Portal.

Certificate Template Name Extension

The Cisco ISE Internal CA includes an extension to represent the certificate template that was used to create the endpoint certificate. All endpoint certificates issued by the internal CA contain a certificate template name extension. This extension represents the certificate template that was used to create that endpoint certificate. The extension ID is 1.3.6.1.4.1.9.21.2.5. You can use the CERTIFICATE: Template Name attribute in authorization policy conditions and assign appropriate access privileges based on the results of the evaluation.

Use Certificate Template Name in Authorization Policy Conditions

You can use the certificate template name extension in authorization policy rules.

-
- Step 1** Choose **Policy > Authorization**.
- Step 2** Add a new rule or edit an existing rule. This example describes editing the `Compliant_Device_Access` rule:
- Edit the `Compliant_Device_Access` rule.
 - Choose **Add Attribute/Value**.
 - From Dictionaries, choose the **CERTIFICATE: Template Name** attribute and **Equals** operator.
 - Enter the value of the certificate template name. For example, `EAP_Authentication_Certificate_Template`.
- Step 3** Click **Save**.
-

Deploy Cisco ISE CA Certificates for pxGrid Controller

Cisco ISE CA provides a certificate template for the pxGrid controller to generate a certificate from the Certificate Provisioning Portal.

Before you begin

Generate a certificate signing request (CSR) for the pxGrid client and copy the contents of the CSR in to the clipboard.

-
- Step 1** Create a network access user account (Administration > Identity Management > Identities > Users > Add).
Make note of the user group to which the user is assigned.
- Step 2** Edit the Certificate Provisioning Portal Settings (Administration > Device Portal Management > Certificate Provisioning).
- Select the certificate provisioning portal and click **Edit**.
 - Click the **Portal Settings** drop-down list. From the Configure authorized groups Available list, select the user group to which the network access user belongs to and move it to Chosen list.
 - Click the **Certificate Provisioning Portal Settings** drop-down list. Choose the `pxGrid_Certificate_Template`. See [Portal Settings for Certificate Provisioning Portal](#) for more information.
 - Save the portal settings.
- Step 3** Launch the Certificate Provisioning Portal. Click the Portal Test URL link.
- Log in to the Certificate Provisioning Portal using the user account created in step 1.
 - Accept the AUP and click **Continue**.
 - From the **I want to** drop-down list, choose **Generate a single certificate (with certificate signing request)**.
 - In the Certificate Signing Request Details field, paste the contents of the CSR from the clipboard.
 - From the **Certificate Download Format** drop-down list, choose **PKCS8 format**.
- Note** If you choose the PKCS12 format, you must convert the single certificate file in to separate certificate and key files. The certificate and key files must be in binary DER encoded or PEM format before you can import them in to Cisco ISE.
- From the **Choose Certificate Template** drop-down list, choose `pxGrid_Certificate_Template`.
 - Enter a certificate password.

- h) Click **Generate**.
The certificate is generated.
- i) Export the certificate.
The certificate along with the certificate chain is exported.

Step 4 Import the Cisco ISE CA chain in to the Trusted Certificates store in the pxGrid client.

Simple Certificate Enrollment Protocol Profiles

To help enable certificate provisioning functions for the variety of mobile devices that users can register on the network, Cisco ISE enables you to configure one or more Simple Certificate Enrollment Protocol (SCEP) Certificate Authority (CA) profiles (called as Cisco ISE External CA Settings) to point Cisco ISE to multiple CA locations. The benefit of allowing for multiple profiles is to help ensure high availability and perform load balancing across the CA locations that you specify. If a request to a particular SCEP CA goes unanswered three consecutive times, Cisco ISE declares that particular server unavailable and automatically moves to the CA with the next lowest known load and response times, then it begins periodic polling until the server comes back online.

For details on how to set up your Microsoft SCEP server to interoperate with Cisco ISE, see

http://www.cisco.com/en/US/solutions/collateral/ns340/ns414/ns742/ns744/docs/howto_60_byod_certificates.pdf.

Issued Certificates

The Admin portal lists all the certificates issued by the internal ISE CA to endpoints (Administration > System > Certificates > Endpoint Certificates). The Issued Certificates page provides you an at-a-glance view of the certificate status. You can mouse over the Status column to find out the reason for revocation if a certificate has been revoked. You can mouse over the Certificate Template column to view additional details such as Key Type, Key Size or Curve Type, Subject, Subject Alternative Name (SAN), and Validity of the certificate. You can click on the endpoint certificate to view the certificate.

All certificates issued by the ISE CA (certificates automatically provisioned through the BYOD flow and certificates obtained from the Certificate Provisioning portal) are listed in the Endpoint Certificates page. You can manage these certificates from this page.

For example, if you want to view the certificates issued to user7, enter user7 in the text box that appears below the Friendly Name field. All the certificates issued by Cisco ISE to this user appear. Remove the search term from the text box to cancel the filter. You can also use the Advanced Filter option to view records based on various search criteria.

This Endpoint Certificates page also provides you the option to revoke an endpoint certificate, if necessary.

The Certificate Management Overview page displays the total number of endpoint certificates issued by each PSN node in your deployment. You can also view the total number of revoked certificates per node and the total number of certificates that have failed. You can filter the data on this page based on any of the attributes.



Note pxGrid certificates are not listed in the Issued Certificates page.

Backup and Restoration of Cisco ISE CA Certificates and Keys

You must back up the Cisco ISE CA certificates and keys securely to be able to restore them back on a Secondary Administration Node in case of a PAN failure and you want to promote the Secondary Administration Node to function as the root CA or intermediate CA of an external PKI. The Cisco ISE configuration backup does not include the CA certificates and keys. Instead, you should use the Command Line Interface (CLI) to export the CA certificates and keys to a repository and to import them. The **application configure ise** command now includes export and import options to backup and restore CA certificates and keys.

The following certificates from the Trusted Certificates Store are restored on the Secondary Administration Node:

- Cisco ISE Root CA certificate
- Cisco ISE Sub CA certificate
- Cisco ISE Endpoint RA certificate
- Cisco ISE OCSP Responder certificate

You must back up and restore Cisco ISE CA certificates and keys when you:

- Have a Secondary Administration Node in the deployment
- Replace the entire Cisco ISE CA root chain
- Configure Cisco ISE root CA to act as a subordinate CA of an external PKI
- Upgrade from Release 1.2 to a later release
- Restore data from a configuration backup. In this case, you must first regenerate the Cisco ISE CA root chain and then back up and restore the ISE CA certificates and keys.

Export Cisco ISE CA Certificates and Keys

You must export the CA certificates and keys from the PAN to import them on the Secondary Administration Node. This option enables the Secondary Administration Node to issue and manage certificates for endpoints when the PAN is down and you promote the Secondary Administration Node to be the PAN.

Before you begin

Ensure that you have created a repository to store the CA certificates and keys.

-
- Step 1** Enter **application configure ise** command from the Cisco ISE CLI.
 - Step 2** Enter **7** to export the certificates and keys.
 - Step 3** Enter the repository name.
 - Step 4** Enter an encryption key.

A success message appears with the list of certificates that were exported, along with the subject, issuer, and serial number.

Example:

```
The following 4 CA key pairs were exported to repository 'sftp' at 'ise_ca_key_pairs_of_ise-vm1':
Subject:CN=Cisco ISE Self-Signed CA of ise-vm1
Issuer:CN=Cisco ISE Self-Signed CA of ise-vm1
Serial#:0x621867df-568341cd-944cc77f-c9820765
```

```

Subject:CN=Cisco ISE Endpoint CA of ise-vm1
Issuer:CN=Cisco ISE Self-Signed CA of ise-vm1
Serial#:0x7027269d-d80a406d-831d5c26-f5e105fa

Subject:CN=Cisco ISE Endpoint RA of ise-vm1
Issuer:CN=Cisco ISE Endpoint CA of ise-vm1
Serial#:0x1a65ec14-4f284da7-9532f0a0-8ae0e5c2

Subject:CN=Cisco ISE OCSP Responder Certificate of ise-vm1
Issuer:CN=Cisco ISE Self-Signed CA of ise-vm1
Serial#:0x6f6d4097-21f74c4d-8832ba95-4c320fb1
ISE CA keys export completed successfully

```

Import Cisco ISE CA Certificates and Keys

After you register the Secondary Administration Node, you must export the CA certificates and keys from the PAN and import them in to the Secondary Administration Node.

- Step 1** Enter **application configure ise** command from the Cisco ISE CLI.
- Step 2** Enter 8 to import the CA certificates and keys.
- Step 3** Enter the repository name.
- Step 4** Enter the name of the file that you want to import. The file name should be in the format **ise_ca_key_pairs_of_<vm hostname>**.
- Step 5** Enter the encryption key to decrypt the file.

A success message appears.

Example:

```

The following 4 CA key pairs were imported:
  Subject:CN=Cisco ISE Self-Signed CA of ise-vm1
  Issuer:CN=Cisco ISE Self-Signed CA of ise-vm1
  Serial#:0x21ce1000-8008472c-a6bc4fd9-272c8da4

  Subject:CN=Cisco ISE Endpoint CA of ise-vm1
  Issuer:CN=Cisco ISE Self-Signed CA of ise-vm1
  Serial#:0x05fa86d0-092542b4-8ff68ed4-f1964a56

  Subject:CN=Cisco ISE Endpoint RA of ise-vm1
  Issuer:CN=Cisco ISE Endpoint CA of ise-vm1
  Serial#:0x77932e02-e8c84b3d-b27e2f1c-e9f246ca

  Subject:CN=Cisco ISE OCSP Responder Certificate of ise-vm1
  Issuer:CN=Cisco ISE Self-Signed CA of ise-vm1
  Serial#:0x5082017f-330e412f-8d63305d-e13fd2a5

Stopping ISE Certificate Authority Service...
Starting ISE Certificate Authority Service...
ISE CA keys import completed successfully

```

Note Encryption of exported keys file was introduced in Cisco ISE Release 2.6. The export of keys from Cisco ISE Release 2.4 and earlier versions and import of keys in Cisco ISE Release 2.6 and later versions will not be successful.

Generate Root CA and Subordinate CAs on the Primary PAN and PSN

When you set up the deployment, Cisco ISE generates a root CA on the primary PAN and subordinate CA certificates on the PSNs for the Cisco ISE CA service. However, when you change the domain name or the hostname of the primary PAN or PSN, you must regenerate root CA on the primary PAN and sub CAs on the PSNs respectively.

If you want to change the hostname on a PSN, instead of regenerating the root CA and subordinate CAs on the primary PAN and PSNs respectively, you can deregister the PSN before changing the hostname, and register it back. A new subordinate certificate gets provisioned automatically on the PSN.



-
- Note**
- You must regenerate the CA certificate, if you change the domain name or the hostname on a standalone node.
 - You must use SHA-256 signed certificate for Apple iOS 10.3 and above.
-

Step 1 Choose **Administration > System > Certificates > Certificate Signing Requests**

Step 2 Click **Generate Certificate Signing Requests (CSR)**.

Step 3 Choose ISE Root CA from the **Certificate(s) will be used for** drop-down list.

Step 4 Click **Replace ISE Root CA Certificate chain**.

The root CA and subordinate CA certificates get generated for all the nodes in your deployment.

What to do next

If you have a secondary PAN in the deployment, obtain a backup of the Cisco ISE CA certificates and keys from the primary PAN and restore it on the secondary PAN. This ensures that the secondary PAN can function as the root CA in case of a primary PAN failure and you promote the secondary PAN to be the primary PAN.

Configure Cisco ISE Root CA as Subordinate CA of an External PKI

If you want the root CA on the primary PAN to act as a subordinate CA of an external PKI, generate an ISE intermediate CA certificate signing request, send it to the external CA, obtain the root and CA-signed certificates, import the root CA certificate in to the Trusted Certificates Store, and bind the CA-signed certificate to the CSR. In this case, the external CA is the root CA, the Primary PAN is a subordinate CA of the external CA, and the PSNs are subordinate CAs of the primary PAN.

Step 1 Choose **Administration > System > Certificates > Certificate Signing Requests**.

- Step 2** Click **Generate Certificate Signing Requests (CSR)**.
- Step 3** Choose ISE Intermediate CA from the **Certificate(s) will be used for** drop-down list.
- Step 4** Click **Generate**.
- Step 5** Export the CSR, send it to the external CA, and obtain the CA-signed certificate.
- Step 6** Import the root CA certificate from the external CA in to the Trusted Certificates store.
- Step 7** Bind the CA-signed certificate with the CSR.
-

What to do next

If you have a secondary PAN in the deployment, obtain a backup of the Cisco ISE CA certificates and keys from the primary PAN and restore it on the secondary PAN. Server and root certificates are then automatically replicated in the secondary PAN. This ensures that the secondary PAN can function as subordinate CA of the external PKI in case of administration node failover.

Configure Cisco ISE to Use Certificates for Authenticating Personal Devices

You can configure Cisco ISE to issue and manage certificates for endpoints (personal devices) that connect to your network. You can use the internal Cisco ISE CA service to sign the certificate signing request from endpoints or forward the CSR to an external CA.

Before you begin

- Obtain a backup of the Cisco ISE CA certificates and keys from the primary PAN and store them in a secure location for disaster recovery purposes.
 - If you have a secondary PAN in the deployment, back up the Cisco ISE CA certificates and keys from the primary PAN and restore them on the secondary PAN.
-

- Step 1** [Add Users to Employee User Group, on page 177.](#)
You can add users to the internal identity store or to an external identity store such as Microsoft Active Directory.
- Step 2** [Create a Certificate Authentication Profile for TLS-Based Authentication, on page 177 .](#)
- Step 3** [Create an Identity Source Sequence for TLS-Based Authentication, on page 178.](#)
- Step 4** Create a client provisioning policy:
- [Configure Certificate Authority Settings, on page 178](#)
 - [Create a CA Template, on page 179](#)
 - [Create a Native Supplicant Profile to be Used in Client-Provisioning Policy, on page 181](#)
 - [Download Agent Resources from Cisco for Windows and MAC OS X Operating Systems, on page 181](#)
 - [Create Client-Provisioning Policy Rules for Apple iOS, Android, and MAC OS X Devices, on page 182](#)
- Step 5** [Configure the Dot1X Authentication Policy Rule for TLS-Based Authentication, on page 182](#)
- Step 6** Configure authorization policy rules for TLS-based authentications.
- [Create Authorization Profiles for Central Web Authentication and Supplicant-Provisioning Flows, on page 183](#)
 - [Create Authorization Policy Rules, on page 184](#)

When you use ECDHE-RSA based certificates, while connecting to the wireless SSID from your personal device, you will be prompted to enter the password a second time.

Add Users to Employee User Group

The following procedure describes how to add users to the Employee user group in the Cisco ISE identity store. If you are using an external identity store, make sure that you have an Employee user group to which you can add users.

-
- Step 1** Choose **Administration** > **Identity Management** > **Identities** > **Users**.
 - Step 2** Click **Add**.
 - Step 3** Enter the user details.
 - Step 4** In the **Passwords** section, choose the **Login Password** and TACACS+ **Enable Password** to set the access level to a network device.
 - Step 5** Select Employee from the User Group drop-down list.
All users who belong to the Employee user group share the same set of privileges.
 - Step 6** Click **Submit**.
-

What to do next

[Create a Certificate Authentication Profile for TLS-Based Authentication, on page 177](#)

Create a Certificate Authentication Profile for TLS-Based Authentication

To use certificates for authenticating endpoints that connect to your network, you must define a certificate authentication profile in Cisco ISE or edit the default Preloaded_Certificate_Profile. The certificate authentication profile includes the certificate field that should be used as the principal username. For example, if the username is in the Common Name field, then you can define a certificate authentication profile with the Principal Username being the Subject - Common Name, which can be verified against the identity store.

-
- Step 1** Choose **Administration** > **Identity Management** > **External Identity Sources** > **Certificate Authentication Profile**.
 - Step 2** Enter a name for your certificate authentication profile. For example, CAP.
 - Step 3** Choose Subject - Common Name as the **Principal Username X509 Attribute**.
 - Step 4** Click **Save**.
-

What to do next

[Create an Identity Source Sequence for TLS-Based Authentication, on page 178](#)

Create an Identity Source Sequence for TLS-Based Authentication

After you create a certificate authentication profile, you must add it to the identity source sequence so that Cisco ISE can obtain the attribute from the certificate and match it against the identity sources that you have defined in the identity source sequence.

Before you begin

Ensure that you have completed the following tasks:

- Add users to the Employee user group.
- Create a certificate authentication profile for certificate-based authentication.

-
- Step 1** Choose **Administration > Identity Management > Identity Source Sequences**.
- Step 2** Click **Add**.
- Step 3** Enter a name for the identity source sequence. For example, Dot1X.
- Step 4** Check the **Select Certificate Authentication Profile** check box and select the certificate authentication profile that you created earlier, namely CAP.
- Step 5** Move the identity source that contains your user information to the **Selected** list box in the Authentication Search List area.
You can add additional identity sources and Cisco ISE searches these data stores sequentially until a match is found.
- Step 6** Click the **Treat as if the user was not found and proceed to the next store in the sequence** radio button.
- Step 7** Click **Submit**.
-

What to do next

[Configure Certificate Authority Settings, on page 178](#)

Configure Certificate Authority Settings

You must configure the external CA settings if you are going to use an external CA for signing the CSRs. The external CA settings was known as the SCEP RA profile in previous releases of Cisco ISE. If you are using the Cisco ISE CA, then you do not have to explicitly configure the CA settings. You can review the Internal CA settings at Administration > System > Certificates > Internal CA Settings.

Once users' devices receive their validated certificate, they reside on the device as described in the following table.

Table 8: Device Certificate Location

Device	Certificate Storage Location	Access Method
iPhone/iPad	Standard certificate store	Settings > General > Profile

Device	Certificate Storage Location	Access Method
Android	Encrypted certificate store	Invisible to end users. Note Certificates can be removed using Settings > Location & Security > Clear Storage.
Windows	Standard certificate store	Launch mmc.exe from the /cmd prompt or view in the certificate snap-in.
Mac	Standard certificate store	Application > Utilities > Keychain Access

Before you begin

If you are going to use an external Certificate Authority (CA) for signing the certificate signing request (CSR), then you must have the URL of the external CA.

-
- Step 1** Choose **Administration** > **System** > **Certificates** > **External CA Settings**.
- Step 2** Click **Add**.
- Step 3** Enter a name for the external CA setting. For example, EXTERNAL_SCEP.
- Step 4** Enter the external CA server URL in the URL text box.
Click **Test Connection** to check if the external CA is reachable. Click the + button to enter additional CA server URLs.
- Step 5** Click **Submit**.
-

What to do next

[Create a CA Template, on page 179](#)

Create a CA Template

The certificate template defines the SCEP RA profile that must be used (for the internal or external CA), Key Type, Key Size or Curve Type, Subject, Subject Alternative Name (SAN), validity period of the certificate, and the Extended Key Usage. This example assumes that you are going to use the internal Cisco ISE CA. For an external CA template, the validity period is determined by the external CA and you cannot specify it.

You can create a new CA template or edit the default certificate template, EAP_Authentication_Certificate_Template.

By default, the following CA templates are available in Cisco ISE:

- CA_SERVICE_Certificate_Template—For other network services that use the ISE CA. For example, use this certificate template while configuring ISE to issue certificates for ASA VPN users.
- EAP_Authentication_Certificate_Template—For EAP authentication.

- pxGrid_Certificate_Template—For pxGrid controller while generating the certificate from the Certificate Provisioning Portal.



Note Certificate templates that use the ECC key type can be used only with the internal Cisco ISE CA.

Before you begin

Ensure that you have configured the CA settings.

Step 1 Choose **Administration** > **System** > **CA Service** > **Internal CA Certificate Template**.

Step 2 Enter a name for the internal CA template. For example, Internal_CA_Template.

Step 3 (Optional) Enter values for the Organizational Unit, Organization, City, State, and Country fields.

We do not support UTF-8 characters in the certificate template fields (Organizational Unit, Organization, City, State, and Country). Certificate provisioning fails if UTF-8 characters are used in the certificate template.

The username of the internal user generating the certificate is used as the Common Name of the certificate. Cisco ISE Internal CA does not support "+" or "*" characters in the Common Name field. Ensure that your username does not include "+" or "*" special characters.

Step 4 Specify the Subject Alternative Name (SAN) and the validity period of the certificate.

Step 5 Specify a Key Type. Choose RSA or ECC.

The following table lists the operating systems and versions that support ECC along with the curve types that are supported. If your devices are not running a supported operating system or on a supported version, you can use RSA-based certificates instead.

Operating System	Supported Versions	Supported Curve Types
Windows	8 and later	P-256, P-384, and P-521
Android	4.4 and later Note Android 6.0 requires May 2016 patch to support ECC certificates.	All curve types (except Android 6.0, which does not support the P-192 curve type).

Windows 7 and Apple iOS do not natively support ECC for EAP-TLS authentication. This release of Cisco ISE does not support the use of ECC certificates on MAC OS X devices.

If the devices in your network run an operating system that is not supported (Windows 7, MAC OS X, or Apple iOS), we recommend that you choose RSA as the Key Type.

Step 6 (Applicable if you choose the RSA Key Type) Specify a key size. You must choose 1024 or a higher key size.

Step 7 (Applicable only if you choose the ECC Key Type) Specify the Curve Type. The default is P-384.

Step 8 Choose ISE Internal CA as the SCEP RA Profile.

Step 9 Enter the validity period in days. The default is 730 days. Valid range is between 1 and 730.

- Step 10** Specify the Extended Key Usage. Check the **Client Authentication** check box if you want the certificate to be used for client authentication. Check the **Server Authentication** check box if you want the certificate to be used for server authentication.
- Step 11** Click **Submit**.

The internal CA certificate template is created and will be used by the client provisioning policy.

What to do next

[Create a Native Supplicant Profile to be Used in Client-Provisioning Policy, on page 181](#)

Create a Native Supplicant Profile to be Used in Client-Provisioning Policy

You can create native supplicant profiles to enable users to bring personal devices to your Corporate network. Cisco ISE uses different policy rules for different operating systems. Each client provisioning policy rule contains a native supplicant profile, which specifies which provisioning wizard is to be used for which operating system.

Before you begin

- Configure the CA certificate template in Cisco ISE.
- Open up TCP port 8905 and UDP port 8905 to enable client agents and supplicant provisioning wizard installation. For more information about port usage, see the "Cisco ISE Appliance Ports Reference" appendix in the *Cisco Identity Services Engine Hardware Installation Guide*.

Step 1 Choose **Policy > Policy Elements > Results > Client Provisioning > Resources**.

Step 2 Choose **Add > Native Supplicant Profile**.

Step 3 Enter a name for the native supplicant profile. For example, EAP_TLS_INTERNAL.

Step 4 Choose ALL from the **Operating System** drop-down list.

Note The MAC OS version 10.10 user should manually connect to the provisioned SSID for dual-SSID PEAP flow.

Step 5 Check the **Wired** or **Wireless** check box.

Step 6 Choose TLS from the **Allowed Protocol** drop-down list.

Step 7 Choose the CA certificate template that you created earlier.

Step 8 Click **Submit**.

What to do next

[Download Agent Resources from Cisco for Windows and MAC OS X Operating Systems, on page 181](#)

Download Agent Resources from Cisco for Windows and MAC OS X Operating Systems

For Windows and MAC OS X operating systems, you must download the remote resources from the Cisco site.

Before you begin

Ensure that you are able to access the appropriate remote location to download client provisioning resources to Cisco ISE, by verifying that the proxy settings for your network are correctly configured.

-
- Step 1** Choose **Policy > Policy Elements > Resources > Client Provisioning > Resources**.
- Step 2** Choose **Add > Agent resources from Cisco site**.
- Step 3** Check the check boxes next to the **Windows** and **MAC OS X** packages. Be sure to include the latest versions.
- Step 4** Click **Save**.
-

What to do next

[Create Client-Provisioning Policy Rules for Apple iOS, Android, and MAC OS X Devices, on page 182](#)

Create Client-Provisioning Policy Rules for Apple iOS, Android, and MAC OS X Devices

Client provisioning resource policies determine which users receive which version (or versions) of resources (agents, agent compliance modules, and agent customization packages/profiles) from Cisco ISE upon login and user session initiation.

When you download the agent compliance module, it always overwrites the existing one, if any, available in the system.

To enable employees to bring iOS, Android, MAC OS X devices, you must create policy rules for each of these devices on the Client Provisioning Policy page.

Before you begin

You must have configured the required native supplicant profiles and downloaded the required agents from the Client Provisioning Policy pages.

-
- Step 1** Choose **Policy > Client Provisioning**.
- Step 2** Create client provisioning policy rules for Apple iOS, Android, and MAC OS X devices.
- Step 3** Click **Save**.
-

What to do next

[Configure the Dot1X Authentication Policy Rule for TLS-Based Authentication, on page 182](#)

Configure the Dot1X Authentication Policy Rule for TLS-Based Authentication

You must update the Dot1X authentication policy rule for TLS-based authentications.

Before you begin

Ensure that you have the certificate authentication profile created for TLS-based authentication.

-
- Step 1** Choose **Policy > Authentication**.
- Step 2** Click the Rule-Based radio button.
The default rule-based authentication policy includes a rule for Dot1X authentication.
- Step 3** Edit the Dot1X authentication policy rule.
- Step 4** Choose **Actions > Insert new row above** from the Dot1X policy rule.
- Step 5** Enter a name for the rule. For example, eap-tls.
- Step 6** Use the Expression Builder to create the following policy condition: If Network Access:EapAuthentication Equals EAP-TLS, then use the certificate authentication profile that you created earlier.

You can create an additional policy rule based on the Network Access:UseCase attribute. This attribute now includes an EST-CSR-Request value that you can use to define your policy.
- Step 7** Leave the default rule as is.
- Step 8** Click **Save**.
-

What to do next

[Create Authorization Profiles for Central Web Authentication and Supplicant-Provisioning Flows, on page 183](#)

Create Authorization Profiles for Central Web Authentication and Supplicant-Provisioning Flows

You must define authorization profiles to determine the access that must be granted to the user after the certificate-based authentication is successful.

Before you begin

Ensure that you have configured the required access control lists (ACLs) on the wireless LAN controller (WLC). Refer to the *TrustSec How-To Guide: Using Certificates for Differentiated Access* for information on how to create the ACLs on the WLC.

This example assumes that you have created the following ACLs on the WLC.

- NSP-ACL - For native supplicant provisioning
- BLACKHOLE - For restricting access to block listed devices
- NSP-ACL-Google - For provisioning Android devices

-
- Step 1** Choose **Policy > Policy Elements > Results > Authorization > Authorization Profiles**.
- Step 2** Click **Add** to create a new authorization profile.
- Step 3** Enter a name for the authorization profile.
- Step 4** From the **Access Type** drop-down list, choose ACCESS_ACCEPT.
- Step 5** Click **Add** to add the authorization profiles for central web authentication, central web authentication for Google Play, native supplicant provisioning, and native supplicant provisioning for Google.

Step 6 Click **Save**.

What to do next

[Create Authorization Policy Rules, on page 184](#)

Create Authorization Policy Rules

Cisco ISE evaluates the authorization policy rules and grants the user access to the network resources based on the authorization profile specified in the policy rule.

Before you begin

Ensure that you have created the required authorization profiles.

- Step 1** Choose **Policy > Authorization**.
- Step 2** Insert additional policy rules above the default rule.
- Step 3** Click **Save**.
-

CA Service Policy Reference

This section provides reference information for the authorization and client provisioning policy rules that you must create before you can enable the Cisco ISE CA service.

Client-Provisioning Policy Rules for Certificate Services

This section lists the client provisioning policy rules that you must create while using the Cisco ISE certificate services. The following table provides the details.

Rule Name	Identity Groups	Operating Systems	Other Conditions	Results
iOS	Any	Apple iOS All	Condition(s)	EAP_TLS_INTERNAL (the native supplicant profile that you created earlier). If you are using an external CA, select the native supplicant profile that you have created for the external CA.

Rule Name	Identity Groups	Operating Systems	Other Conditions	Results
Android	Any	Android	Condition(s)	EAP_TLS_INTERNAL (the native supplicant profile that you created earlier). If you are using an external CA, select the native supplicant profile that you have created for the external CA.
MAC OS X	Any	MACOSX	Condition(s)	Under the Native Supplicant Configuration, specify the following: <ol style="list-style-type: none"> 1. Config Wizard: Select the MAC OS X supplicant wizard that you downloaded from the Cisco site. 2. Wizard Profile: Choose the EAP_TLS_INTERNAL native supplicant profile that you created earlier. If you are using an external CA, select the native supplicant profile that you have created for the external CA.

Authorization Profiles for Certificate Services

This section lists the authorization profiles that you must create for enabling certificate-based authentication in Cisco ISE. You must have already created the ACLs (NSP-ACL and NSP-ACL-Google) on the wireless LAN controller (WLC).

- CWA - This profile is for devices that go through the central web authentication flow. Check the **Web Authentication** check box, choose Centralized from the drop-down list, and enter NSP-ACL in the ACL text box.

- CWA_GooglePlay - This profile is for Android devices that go through the central web authentication flow. This profile enables Android devices to access Google Play Store and download the Cisco Network Setup Assistant. Check the **Web Authentication** check box, choose Centralized from the drop-down list, and enter NSP-ACL-Google in the ACL text box.
- NSP - This profile is for non-Android devices that go through the supplicant provisioning flow. Check the **Web Authentication** check box, choose Supplicant Provisioning from the drop-down list, and enter NSP-ACL in the ACL text box.
- NSP-Google - This profile is for Android devices that go through the supplicant provisioning flow. Check the **Web Authentication** check box, choose Supplicant Provisioning from the drop-down list, and enter NSP-ACL-Google in the ACL text box.

Review the default Blackhole_Wireless_Access authorization profile. The Advanced Attributes Settings should be:

- Cisco:cisco-av-pair = url-redirect=https://ip:port/blacklistportal/gateway?portal=PortalID
- Cisco:cisco-av-pair = url-redirect-acl=BLACKHOLE

Authorization Policy Rules for Certificate Services

This section lists the authorization policy rules that you must create while enabling the Cisco ISE CA service.

- Corporate Assets-This rule is for corporate devices that connect to the corporate wireless SSID using 802.1X and MSCHAPV2 protocol.
- Android_SingleSSID-This rule is for Android devices that access the Google Play Store to download the Cisco Network Setup Assistant for provisioning. This rule is specific to single SSID setup.
- Android_DualSSID-This rule is for Android devices that access the Google Play Store to download the Cisco Network Setup Assistant for provisioning. This rule is specific to dual SSID setup.
- CWA-This rule is for devices that go through the central web authentication flow.
- NSP-This rule is for devices that go through the native supplicant provisioning flow using a certificate for EAP-TLS authentication.
- EAP-TLS-This rule is for devices that have completed the supplicant provisioning flow and are provisioned with a certificate. They will be given access to the network.

The following table lists the attributes and values that you must choose while configuring authorization policy rules for the Cisco ISE CA service. This example assumes that you have the corresponding authorization profiles configured in Cisco ISE as well.

Rule Name	Conditions	Permissions (Authorization Profiles to be Applied)
Corporate Assets	Corp_Assets AND (Wireless 802.1X AND Network Access:AuthenticationMethod EQUALS MSCHAPV2)	PermitAccess
Android_SingleSSID	(Wireless 802.1X AND Network Access:AuthenticationMethod EQUALS MSCHAPV2 AND Session:Device-OS EQUALS Android)	NSP_Google

Rule Name	Conditions	Permissions (Authorization Profiles to be Applied)
Android_DualSSID	(Wireless_MAB AND Session:Device-OS EQUALS Android)	CWA_GooglePlay
CWA	Wireless_MAB	CWA
NSP	(Wireless 802.1X AND Network Access:AuthenticationMethod EQUALS MSCHAPV2)	NSP
EAP-TLS	(Wireless 802.1X AND Network Access:AuthenticationMethod EQUALS x509_PKI)	PermitAccess

Cisco ISE CA Issues Certificates to ASA VPN Users

ISE CA issues certificates to client machines connecting over ASA VPN. Using this feature, you can automatically provision certificates to end devices that connect over ASA VPN.

Cisco ISE uses the Simple Certificate Enrollment Protocol (SCEP) for enrollment and to provision certificates to the client machines. The AnyConnect client sends the SCEP request to the ASA over an HTTPS connection. The ASA evaluates the request and enforces policies before it relays the request to Cisco ISE over an HTTP connection established between Cisco ISE and ASA. The response from the Cisco ISE CA is relayed back to the client. The ASA cannot read the contents of the SCEP message and functions as a proxy for the Cisco ISE CA. The Cisco ISE CA decrypts the SCEP message from the client and sends the response in an encrypted form.

The ISE CA SCEP URL is `http://<IP Address or FQDN of ISE CA server>:9090/auth/caservice/pkiclient.exe`. If you are using FQDN of the ISE node, the DNS server connected to ASA must be able to resolve the FQDN.

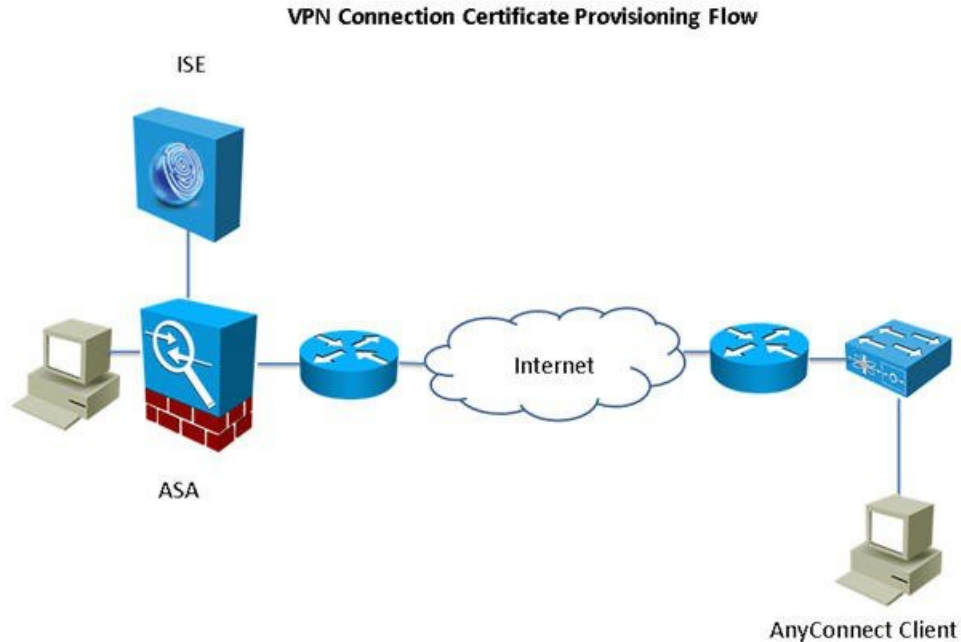
You can configure certificate renewal before expiration in the AnyConnect Client profile. If the certificate has already expired, the renewal flow is similar to a new enrollment.

Supported versions include:

- Cisco ASA 5500 Series Adaptive Security Appliances that run software version 8.x
- Cisco AnyConnect VPN version 2.4 or later

VPN Connection Certificate-Provisioning Flow

Figure 16: Certificate Provisioning for ASA VPN Users



1. The user initiates a VPN connection.
2. The AnyConnect client scans the client machine and sends the attributes such as the unique device identifier (for example, IMEI) to the ASA.
3. The ASA requests certificate-based authentication from the client. The authentication fails because there is no certificate.
4. The ASA proceeds to primary user authentication (AAA) using the username/password and passes the information to the authentication server (ISE).
 - a. If authentication fails, the connection is terminated immediately.
 - b. If authentication passes, limited access is granted. You can configure dynamic access policies (DAP) for client machines that request a certificate using the `aaa.cisco.sceprequired` attribute. You can set the value for this attribute to “true” and apply ACLs and web ACLs.
5. The VPN connection is established after the relevant policies and ACLs are applied. The client starts key generation for SCEP only after AAA authentication succeeds and the VPN connection is established.
6. The client starts the SCEP enrollment and sends SCEP requests to ASA over HTTP.
7. ASA looks up the session information of the request and relays the request to ISE CA, if the session is allowed for enrollment.
8. ASA relays the response from ISE CA back to the client.
9. If enrollment succeeds, the client presents a configurable message to the user and disconnects the VPN session.

10. The user can again authenticate using the certificate and a normal VPN connection is established.

Configure Cisco ISE CA to Issue Certificates to ASA VPN Users

You must perform the following configurations on Cisco ISE and ASA to provision certificates to ASA VPN users.

Before you begin

- Ensure that the VPN user account is present in Cisco ISE internal or external identity source.
- Ensure that the ASA and the Cisco ISE Policy Service Nodes are synchronized using the same NTP server.

-
- Step 1** Define the ASA as a network access device in Cisco ISE. See [Add a Network Device in Cisco ISE, on page 189](#) for information on how to add ASA as a network device.
 - Step 2** [Configure Group Policy in ASA, on page 190.](#)
 - Step 3** [Configure AnyConnect Connection Profile for SCEP Enrollment, on page 190.](#)
 - Step 4** [Configure a VPN Client Profile in ASDM, on page 191.](#)
 - Step 5** [Import Cisco ISE CA Certificates into ASA.](#)
-

Add a Network Device in Cisco ISE

You can add a network device in Cisco ISE or use the default network device.

You can also add a network device in the **Network Devices (Work Centers > Device Administration > Network Resources > Network Devices)** window.

Before you begin

The AAA function must be enabled on the network device to be added. See [Command to Enable AAA Functions, on page 1178.](#)

-
- Step 1** Choose **Administration > Network Resources > Network Devices**.
 - Step 2** Click **Add**.
 - Step 3** Enter the corresponding values in the **Name**, **Description**, and **IP Address** fields.
 - Step 4** Choose the required values from the **Device Profile**, **Model Name**, **Software Version**, and **Network Device Group** drop-down lists.
 - Step 5** (Optional) Check the **RADIUS Authentication Settings** check box to configure the RADIUS protocol for authentication.
 - Step 6** (Optional) Check the **TACACS Authentication Settings** check box to configure the TACACS protocol for authentication.
 - Step 7** (Optional) Check the **SNMP Settings** check box to configure SNMP for the Cisco ISE profiling service to collect information from the network device.
 - Step 8** (Optional) Check the **Advanced Trustsec Settings** check box to configure a Cisco TrustSec-enabled device.
 - Step 9** Click **Submit**.
-

Configure Group Policy in ASA

Configure a group policy in ASA to define the ISE CA URL for AnyConnect to forward the SCEP enrollment request.

-
- Step 1** Log in to Cisco ASA ASDM.
- Step 2** From the Remote Access VPN navigation pane on the left, click **Group Policies**.
- Step 3** Click **Add** to create a group policy.
- Step 4** Enter a name for the group policy. For example, ISE_CA_SCEP.
- Step 5** In the SCEP forwarding URL field, uncheck the **Inherit** check box and enter the ISE SCEP URL with port number.
- If you are using the FQDN of the ISE node, the DNS server connected to ASA must be able to resolve the FQDN of the ISE node.
- Example:**
- http://ise01.cisco.com:9090/auth/caservice/pkiclient.exe.
- Step 6** Click **OK** to save the group policy.
-

Configure AnyConnect Connection Profile for SCEP Enrollment

Configure an AnyConnect connection profile in ASA to specify the ISE CA server, authentication method, and ISE CA SCEP URL.

-
- Step 1** Log in to Cisco ASA ASDM.
- Step 2** From the Remote Access VPN navigation pane on the left, click **AnyConnect Connection Profiles**.
- Step 3** Click **Add** to create a connection profile.
- Step 4** Enter a name for the connection profile. For example, Cert-Group.
- Step 5** (Optional) Enter a description for the connection profile in the Aliases field. For example, SCEP-Call-ASA.
- Step 6** In the Authentication area, specify the following:
- Method—Click the **Both** radio button
 - AAA Server Group—Click **Manage** and choose your ISE server
- Step 7** In the Client Address Assignment area, select the DHCP server and client address pools to use.
- Step 8** In the Default Group Policy area, click **Manage** and select the Group Policy that you have created with the ISE SCEP URL and port number.
- Example:**
- For example, ISE_CA_SCEP.
- Step 9** Choose **Advanced** > **General** and check the **Enable Simple Certificate Enrollment Protocol** check box for this connection profile.
- Step 10** Click **OK**.
Your AnyConnect connection profile is created.
-

What to do next

Configure a VPN Client Profile in ASDM

Configure a VPN client profile in AnyConnect for SCEP enrollment.

-
- Step 1** Log in to Cisco ASA ASDM.
- Step 2** From the Remote Access VPN navigation pane on the left, click **AnyConnect Client Profile**.
- Step 3** Select the client profile that you want to use and click **Edit**.
- Step 4** Click **Certificate Enrollment** from the Profile navigation pane on the left.
- Step 5** Check the **Certificate Enrollment** check box.
- Step 6** Enter the values in the following fields:
- **Certificate Expiration Threshold**—The number of days before the certificate expiration date that AnyConnect warns users their certificate is going to expire (not supported when SCEP is enabled). The default is zero (no warning displayed). The range of values is zero to 180 days.
 - **Automatic SCEP Host**—Enter the host name and connection profile (tunnel group) of the ASA that has SCEP certificate retrieval configured. Enter a Fully Qualified Domain Name (FQDN) or a connection profile name of the ASA. For example, the hostname `asa.cisco.com` and the connection profile name `Cert_Group`.
 - **CA URL**—Identifies the SCEP CA server. Enter the FQDN or IP Address of the ISE server. For example, `http://ise01.cisco.com:9090/auth/caservice/pki/client.exe`.
- Step 7** Enter values for the Certificate Contents that define how the client requests the contents of the certificate.
- Step 8** Click **OK**.
The AnyConnect client profile is created. Refer to the [Cisco AnyConnect Secure Mobility Client](#) for your version of AnyConnect for additional information.
-

Import Cisco ISE CA Certificates into ASA

Import the Cisco ISE internal CA certificates into the ASA.

Before you begin

Export the Cisco ISE internal CA certificates. Go to **Administration > System > Certificates > Certificate Authority > Certificate Authority Certificates**. Check the check boxes next to **Certificate Services Node CA** and **Certificate Services Root CA** certificates and export them, one certificate at a time.

-
- Step 1** Log in to Cisco ASA ASDM.
- Step 2** From the Remote Access VPN navigation pane on the left, choose **Certificate Management > CA Certificates**.
- Step 3** Click **Add** and select the Cisco ISE internal CA certificates to import them in to ASA.
-

Revoke an Endpoint Certificate

If you need to revoke a certificate issued to an employee's personal device, you can revoke it from the Endpoint Certificates page. For example, if an employee's device has been stolen or lost, you can log in to the Cisco

ISE Admin portal and revoke the certificate issued to that device from the Endpoint Certificates page. You can filter the data on this page based on the Friendly Name, Device Unique Id, or Serial Number.

If a PSN (sub CA) is compromised, you can revoke all certificates issued by that PSN by filtering on the Issued By field from the Endpoint Certificates page.

When you revoke a certificate issued to an employee, if there is an active session (authenticated using that certificate), the session is terminated immediately. Revoking a certificate ensures that unauthorized users do not have any access to resources as soon as the certificate is revoked.

-
- Step 1** Choose **Administration > System > Certificates > Certificate Authority > Issued Certificates**.
- Step 2** Check the check box next to the endpoint certificate that you want to revoke and click **Revoke**. You can search for the certificate based on the Friendly Name and Device Type.
- Step 3** Enter the reason for revoking the certificate.
- Step 4** Click **Yes**.
-

OCSP Services

The Online Certificate Status Protocol (OCSP) is a protocol that is used for checking the status of x.509 digital certificates. This protocol is an alternative to the Certificate Revocation List (CRL) and addresses issues that result in handling CRLs.

Cisco ISE has the capability to communicate with OCSP servers over HTTP to validate the status of certificates in authentications. The OCSP configuration is configured in a reusable configuration object that can be referenced from any certificate authority (CA) certificate that is configured in Cisco ISE.

You can configure CRL and/or OCSP verification per CA. If both are selected, then Cisco ISE first performs verification over OCSP. If a communication problem is detected with both the primary and secondary OCSP servers, or if an unknown status is returned for a given certificate, Cisco ISE switches to checking the CRL.

Cisco ISE CA Service Online Certificate Status Protocol Responder

The Cisco ISE CA OCSP responder is a server that communicates with OCSP clients. The OCSP clients for the Cisco ISE CA include the internal Cisco ISE OCSP client and OCSP clients on the Adaptive Security Appliance (ASA). The OCSP clients should communicate with the OCSP responder using the OCSP request/response structure defined in RFC 2560, 5019.

The Cisco ISE CA issues a certificate to the OCSP responder. The OCSP responder listens on port 2560 for any incoming requests. This port is configured to allow only OCSP traffic.

The OCSP responder accepts a request that follows the structure defined in RFC 2560, 5019. Nonce extension is supported in the OCSP request. The OCSP responder obtains the status of the certificate and creates an OCSP response and signs it. The OCSP response is not cached on the OCSP responder, although you can cache the OCSP response on the client for a maximum period of 24 hours. The OCSP client should validate the signature in the OCSP response.

The self-signed CA certificate (or the intermediate CA certificate if ISE acts as an intermediate CA of an external CA) on the PAN issues the OCSP responder certificate. This CA certificate on the PAN issues the OCSP certificates on the PAN and PSNs. This self-signed CA certificate is also the root certificate for the

entire deployment. All the OCSP certificates across the deployment are placed in the Trusted Certificates Store for ISE to validate any response signed using these certificates.



Note Cisco ISE receives from OCSP responder servers a `thisUpdate` value, which indicates the time since the last certificate revocation. If the `thisUpdate` value is greater than 7 days, the OCSP certificate verification fails in Cisco ISE.

OCSP Certificate Status Values

OCSP services return the following values for a given certificate request:

- **Good**—Indicates a positive response to the status inquiry. It means that the certificate is not revoked, and the state is good only until the next time interval (time to live) value.
- **Revoked**—The certificate was revoked.
- **Unknown**—The certificate status is unknown. OCSP service returns this value if the certificate was not issued by the CA of this OCSP responder.
- **Error**—No response was received for the OCSP request.

OCSP High Availability

Cisco ISE has the capability to configure up to two OCSP servers per CA, and they are called primary and secondary OCSP servers. Each OCSP server configuration contains the following parameters:

- **URL**—The OCSP server URL.
- **Nonce**—A random number that is sent in the request. This option ensures that old communications cannot be reused in replay attacks.
- **Validate response**—Cisco ISE validates the response signature that is received from the OCSP server.

In case of timeout (which is 5 seconds), when Cisco ISE communicates with the primary OCSP server, it switches to the secondary OCSP server.

Cisco ISE uses the secondary OCSP server for a configurable amount of time before attempting to use the primary server again.

OCSP Failures

The three general OCSP failure scenarios are as follows:

- Failed OCSP cache or OCSP client side (Cisco ISE) failures.
- Failed OCSP responder scenarios, for example:

The first primary OCSP responder not responding, and the secondary OCSP responder responding to the Cisco ISE OCSP request.

Errors or responses not received from Cisco ISE OCSP requests.

An OCSP responder may not provide a response to the Cisco ISE OCSP request or it may return an OCSP Response Status as not successful. OCSP Response Status values can be as follows:

- tryLater
- signRequired
- unauthorized
- internalError
- malformedRequest

There are many date-time checks, signature validity checks and so on, in the OCSP request. For more details, refer to *RFC 2560 X.509 Internet Public Key Infrastructure Online Certificate Status Protocol - OCSP* which describes all the possible states, including the error states.

- Failed OCSP reports

Add OCSP Client Profiles

You can use the OCSP Client Profile page to add new OCSP client profiles to Cisco ISE.

Before you begin

If the Certificate Authority (CA) is running the OCSP service on a nonstandard port (other than 80 or 443), you must configure ACLs on the switch to allow for communication between Cisco ISE and the CA on that port. For example:

```
permit tcp <source ip> <destination ip> eq <OCSP port number>
```

-
- Step 1** Choose **Administration > System > Certificates > Certificate Management > OCSP Client Profile**.
- Step 2** Enter the values to add an OCSP Client Profile.
- Step 3** Click **Submit**.
-

OCSP Statistics Counters

Cisco ISE uses OCSP counters to log and monitor the data and health of the OCSP servers. Logging occurs every five minutes. Cisco ISE sends a syslog message to the Monitoring node and it is preserved in the local store. The local store contains data from the previous five minutes. After Cisco ISE sends the syslog message, the counters are recalculated for the next interval. This means, after five minutes, a new five-minute window interval starts again.

The following table lists the OCSP syslog messages and their descriptions.

Table 9: OCSP Syslog Messages

Message	Description
OCSPPrimaryNotResponsiveCount	The number of nonresponsive primary requests

Message	Description
OCSPSecondaryNotResponsiveCount	The number of nonresponsive secondary requests
OCSPPrimaryCertsGoodCount	The number of 'good' certificates that are returned for a given CA using the primary OCSP server
OCSPSecondaryCertsGoodCount	The number of 'good' statuses that are returned for a given CA using the primary OCSP server
OCSPPrimaryCertsRevokedCount	The number of 'revoked' statuses that are returned for a given CA using the primary OCSP server
OCSPSecondaryCertsRevokedCount	The number of 'revoked' statuses that are returned for a given CA using the secondary OCSP server
OCSPPrimaryCertsUnknownCount	The number of 'Unknown' statuses that are returned for a given CA using the primary OCSP server
OCSPSecondaryCertsUnknownCount	The number of 'Unknown' statuses that are returned for a given CA using the secondary OCSP server
OCSPPrimaryCertsFoundCount	The number of certificates that were found in cache from a primary origin
OCSPSecondaryCertsFoundCount	The number of certificates that were found in cache from a secondary origin
ClearCacheInvokedCount	How many times clear cache was triggered since the interval
OCSPCertsCleanedUpCount	How many cached entries were cleaned since the t interval
NumOfCertsFoundInCache	Number of the fulfilled requests from the cache
OCSPCacheCertsCount	Number of certificates that were found in the OCSP cache

Requirements for CA to Interoperate with Cisco ISE

While using a CA server with Cisco ISE, make sure that the following requirements are met:

- Key size should be 1024, 2048, or higher. In CA server, the key size is defined using certificate template. You can define the key size on Cisco ISE using the supplicant profile.
- Key usage should allow signing and encryption in extension.
- While using GetCACapabilities through the SCEP protocol, cryptography algorithm and request hash should be supported. It is recommended to use RSA and SHA1.
- Online Certificate Status Protocol (OCSP) is supported. This is not directly used in BYOD, but a CA which can act as an OCSP server can be used for certificate revocation.



Note Enterprise Java Beans Certificate Authority (EJBCA) is not supported by Cisco ISE for proxy SCEP. EJBCA is supported by Cisco ISE for standard EAP authentication like PEAP, EAP-TLS, and so on.

- If you use an enterprise PKI to issue certificates for Apple iOS devices, ensure that you configure key usage in the SCEP template and enable the **Key Encipherment** option.

If you use Microsoft CA, edit the Key Usage Extension in the certificate template. In the **Encryption** area, click the **Allow Key Exchange only with Key Encryption (Key encipherment)** radio button and check the **Allow Encryption of User Data** check box.

- Cisco ISE supports the use of RSASSA-PSS algorithm for trusted certificates and endpoint certificates for EAP-TLS authentication. When you view the certificate, the signature algorithm is listed as 1.2.840.113549.1.1.10 instead of the algorithm name.



Note If you use the Cisco ISE internal CA for the BYOD flow, the Admin certificate should not be signed using the RSASSA-PSS algorithm (by an external CA). The Cisco ISE internal CA cannot verify an Admin certificate that is signed using this algorithm and the request would fail.

Client Certificate Requirements for Certificate-Based Authentication

For certificate-based authentication with Cisco ISE, the client certificate should meet the following requirements:

Table 10: Client-Certificate Requirements for RSA and ECC

RSA		
Supported Key Sizes	1024, 2048, and 4096 bits	
Supported Secure Hash Algorithms (SHA)	SHA-1 and SHA-2 (includes SHA-256)	
ECC ^{1 2}		
Supported Curve Types	P-192, P-256, P-384, and P-521	
Supported Secure Hash Algorithm (SHA)	SHA-256	
Client Machine Operating Systems and Supported Curve Types		
Windows	8 and later	P-256, P-384, and P-521
Android	4.4 and later Note Android 6.0 requires May 2016 patch to support ECC certificates.	All curve types (except Androidv6.0, which does not support the P-192 curve type).

- ¹ Windows 7 and Apple iOS do not natively support ECC for EAP-TLS authentication.
- ² This release of Cisco ISE does not support the use of ECC certificates on MAC OS X devices.



CHAPTER 9

Control Device Administration Using TACACS+

- [TACACS+ Device Administration, on page 199](#)
- [Device Administration Work Center, on page 201](#)
- [Data Migration from Cisco Secure ACS to Cisco ISE, on page 201](#)
- [Device Administration Deployment Settings, on page 202](#)
- [Device Admin Policy Sets, on page 202](#)
- [TACACS+ Authentication Settings and Shared Secret, on page 203](#)
- [Device Administration - Authorization Policy Results, on page 204](#)
- [Create Device Administration Policy Sets, on page 210](#)
- [Monitor Device Administration Activity, on page 212](#)
- [Configure Global TACACS+ Settings, on page 212](#)

TACACS+ Device Administration

Cisco ISE supports device administration using the Terminal Access Controller Access-Control System (TACACS+) security protocol to control and audit the configuration of network devices. The network devices are configured to query Cisco ISE for authentication and authorization of device administrator actions, and send accounting messages for Cisco ISE to log the actions. It facilitates granular control of who can access which network device and change the associated network settings. A Cisco ISE administrator can create policy sets that allow TACACS results, such as command sets and shell profiles, to be selected in authorization policy rules in a device administration access service. The Cisco ISE Monitoring node provides enhanced reports related to device administration. The Work Center menu contains all the device administration pages, which act as a single start point for ISE administrators.

Cisco ISE requires a Device Administration license to use TACACS+.

There are two types of administrators for device administration:

- Device Administrator
- Cisco ISE Administrator

The device administrator is the user who logs into the network devices such as switches, wireless access points, routers, and gateways, (normally through SSH), in order to perform the configuration and maintenance of the administered devices. The Cisco ISE administrator logs into Cisco ISE to configure and coordinate the devices that a device administrator logs in to.

The Cisco ISE administrator is the intended reader of this document, who logs into Cisco ISE to configure the settings that control the operations of the device administrator. The Cisco ISE administrator uses the device administration features (**Work centers > Device Administration**) to control and audit the configuration of the network devices. A device can be configured to query the Cisco ISE server using the Terminal Access Controller Access-Control System (TACACS) security protocol. The Cisco ISE Monitoring node provides enhanced reports related to device administration. A Cisco ISE administrator can perform the following tasks:

- Configure network devices with the TACACS+ details (shared secret).
- Add device administrators as internal users and set their enable passwords as needed.
- Create policy sets that allow TACACS results, such as command sets and shell profiles, to be selected in authorization policy rules in a device administration access service.
- Configure the TACACS server in Cisco ISE to allow device administrators to access devices based on the policy sets.

The device administrator performs the task of setting up a device to communicate with the Cisco ISE server. When a device administrator logs on to a device, the device queries the Cisco ISE server, which in turn queries an internal or external identity store, to validate the details of the device administrator. When the validation is done by the Cisco ISE server, the device informs the Cisco ISE server of the final outcome of each session or command authorization operation for accounting and auditing purposes.

A Cisco ISE administrator can manage device administration using TACACS and Cisco ISE 2.0 and later releases. The configuration related to device administration can also be migrated from a Cisco Secure Access Control System (ACS) server, versions 5.5, 5.6, 5.7 and 5.8. Prior versions need to be upgraded to 5.5 or 5.6 before migration.



Note You should check the **Enable Device Admin Service** check box in the **Administration > System > Deployment > General Settings** page to enable TACACS+ operations. Ensure that this option is enabled in each PSN in a deployment.



Note Cisco ISE requires a Device Administration license to use the TACACS+ service on top of an existing Base or Mobility license. The Device Administration license is a perpetual license. If you are upgrading from an earlier release to Cisco ISE Release 2.0 and later, and would like to enable the TACACS+ service, you must order the Device Administration license as a separate add-on license. You need one Device Administration license for the entire ISE deployment.

[ISE Community Resource](#)

For information about device administration attributes, see [ISE Device Administration Attributes](#).

For information about TACACS+ configuration for Wireless LAN controllers, IOS network devices, Cisco NX-OS network devices, and network devices, see [ISE Device Administration \(TACACS+\)](#).

Access the Command-Line Interface to Change the Enable Password

To change Enable password, perform the following steps:

Before you begin

Some commands are assigned to privileged mode. Therefore, they can only be executed when the device administrator has authenticated into this mode.

The device sends a special enable authentication type when the device administrator attempts to enter the privileged mode. Cisco ISE supports a separate enable password to validate this special enable authentication type. The separate enable password is used when the device administrator is authenticated with internal identity stores. For authentication with external identity stores, the same password is used as for regular login.

Step 1 Log in to the switch.

Step 2 Press Enter to display the following prompt:

```
Switch>
```

Step 3 Execute the following commands to configure the Enable password.

```
Switch> enable
Password: (Press Enter to leave the password blank.)
Enter Old Password: (Enter the old password.)
Enter New Password: (Enter the new password.)
Enter New Password Confirmation: (Confirm the new password.)
```

Note If password lifetime is configured for the Login password and Enable password, the user account will be disabled if the passwords are not changed within the specified time period. If Cisco ISE is configured as TACACS+ server and the **Enable Bypass** option is configured on the network device, you cannot change the Enable password from the CLI (via telnet). Choose **Administration > Identity Management > Identities > Users** to change the Enable password for internal users.

Device Administration Work Center

The Work Center menu contains all the device administration pages, which act as a single start point for Cisco ISE administrators. However, pages that are not specific to device administration such as Users, User Identity Groups, Network Devices, Default Network Devices, Network Device Groups, Authentication and Authorization Conditions, can still be accessed from their original menu options, such as Administration. The Work Centers option is available only if the correct TACACS+ license(s) are obtained and installed.

The Device Administration Menu contains the following menu options: Overview, Identities, User Identity Groups, Ext ID Stores, Network Resources, Network Device Groups, Policy Elements, Device Admin Policy Sets, Reports, and Settings.

Data Migration from Cisco Secure ACS to Cisco ISE

You can use the migration tool to import data from ACS 5.5, 5.6, 5.7, and 5.8, and set default TACACS+ secret for all network devices. Navigate to **Work Centers > Device Administration > Overview** and in the **Prepare** section, click the migration tool link to open the migration tool **Download Software Webpage** to download the migration tool. Save the tool to your PC, and from the migTool folder, run the migration.bat file to start the migration process. For complete information related to the migration, refer to the [Migration Guide](#) for your version of Cisco ISE.

Device Administration Deployment Settings

The Device Administration Deployment page (**Work Centers > Device Administration > Overview > Deployment**) allows Cisco ISE administrators to centrally view the device administration system without referring to each node in the deployment section.

The Device Administration Deployment page lists the PSNs in your deployment. This simplifies the task of enabling the device admin service individually in each PSN in your deployment. You can collectively enable the device admin service for many PSNs by selecting an option below:

Option	Description
None	By default, the device administration service is disabled for all nodes.
All Policy Service Nodes	Enables the device administration service in all PSNs. With this option, new PSNs are automatically enabled for device admin when they are added.
Specific Nodes	Displays the ISE Nodes section that lists all the PSNs in your deployment. You can select the required nodes that necessitate the device admin service to be enabled.



Note If the deployment is not licensed for TACACS+, the above options are disabled.

The TACACS Ports field allows you to enter a maximum of four TCP ports, which are comma-separated and port values range from 1 to 65535. Cisco ISE nodes and their interfaces listen for TACACS+ requests on the specified ports and you must ensure that the specified ports are not used by other services. The default TACACS+ port value is 49.

When you click **Save**, the changes are synchronized with the nodes specified in the **Administration > System > Deployment Listing** window.

Device Admin Policy Sets

A Regular policy set comprises an authentication rule table and an authorization rule table. The authentication rule table consists of a set of "outer" rules that are used to select the protocols that should be allowed. Each "outer" rule contains one or more "inner" rules that are used to select the specific identity store to use. The authorization rule table contains a set of rules to select the specific authorization results required to implement the authorization business model. Each rule consists of one or more conditions that must be matched for the rule to be engaged, and a set of command sets, and/or a shell profile, which are selected to control the authorization process. Each policy set has an authorization exceptions rule table that can be used to override the rules for specific circumstances, often the exception table is used for temporary situations.



Note TACACS+ CHAP outbound authentication is not supported.

A Proxy Sequence policy set contains a single selected proxy sequence. If the policy set is in this mode then one or more remote proxy servers are used to process the requests (although local accounting may be configured by the Proxy Sequence).

TACACS+ Authentication Settings and Shared Secret

The following table describes the fields on the Network Devices window, which you can use to configure TACACS+ authentication settings for a network device. The navigation path is:

- (For Network Devices) **Work Centers > Device Administration > Network Resources > Network Devices > Add > TACACS Authentication Settings.**
- (For Default Devices) **Work Centers > Device Administration > Network Resources > Default Devices > TACACS Authentication Settings.** See [Define a Default Network Device in Cisco ISE](#) for more information.

Field Name	Usage Guidelines
Shared Secret	A string of text assigned to a network device when TACACS+ protocol is enabled. A user must enter the text before the network device authenticates a username and password. The connection is rejected until the user supplies the shared secret. This is not a mandatory field.
Retired Shared Secret is Active	Displayed when the retirement period is active.
Retire	Retires an existing shared secret instead of ending it. When you click Retire, a message box is displayed. You can either click Yes or No .
Remaining Retired Period	(Available only if you select Yes in the above message box) Displays the default value specified in the following navigation path: Work Centers > Device Administration > Settings > Connection Settings > Default Shared Secret Retirement Period. You can change the default values. This allows a new shared secret to be entered and the old shared secret will remain active for the specified number of days.
End	(Available only if you select Yes in the above message box) Ends the retirement period and terminates the old shared secret.

Field Name	Usage Guidelines
Enable Single Connect Mode	<p>Check to use a single TCP connection for all TACACS+ communication with the network device. Choose one of the following:</p> <ul style="list-style-type: none"> • Legacy Cisco Devices • Or, TACACS+ Draft Compliance Single Connect Support. If you disable Single Connect Mode, ISE uses a new TCP connection for every TACACS+ request.

In summary, you can

- Retire the old shared secret by specifying the retirement period as number of days (Range is 1 to 99) and at the same time set a new shared secret.
- Use the old and new shared secrets during the retirement period.
- Extend the retirement period before it expires.
- Use the old shared secret only until the end of the retirement period.
- Terminate the retirement period before it expires (click End and then Submit).



Note Choose **Administration > Network Resources > Network Devices > Add** window to access the TACACS+ Authentication Settings option.

Device Administration - Authorization Policy Results

Cisco ISE administrators can use the TACACS+ command sets and TACACS+ profiles (policy results) to exercise control over the privileges and commands that are granted to a device administrator. The policy works along with the network devices and thereby prevents accidental or malicious configuration changes that may be done. In the event such changes occur, you can use the device administration audit reports to track the device administrator who has executed a particular command.

Allowed Protocols in FIPS and Non-FIPS Modes for TACACS+ Device Administration

There are many allowed authentication protocol services that Cisco ISE offers for creating the policy results. However, authentication protocol services such as PAP/ASCII, CHAP, and MS-CHAPv1, which are applicable to the TACACS+ protocol, are disabled on FIPS-enabled Cisco ISE appliances for RADIUS. As a result, these protocols cannot be enabled in the **Policy > Policy Elements > Results > Allowed Protocols** window to administer devices, when using a FIPS-enabled (**Administration > System Settings > FIPS Mode**) Cisco ISE appliance.

Consequently, to configure PAP/ASCII, CHAP, and MS-CHAPv1 protocols in your device administration policy results, for both FIPS and non-FIPS modes, you must navigate to the **Work Centers > Device Administration > Policy Elements > Results > Allowed Protocols** window. Only the Default Device Admin allowed protocols setting may be used when FIPS mode is enabled. This option is not allowed in RADIUS.

TACACS+ Command Sets

Command sets enforce the specified list of commands that can be executed by a device administrator. When a device administrator issues operational commands on a network device, Cisco ISE is queried to determine whether the administrator is authorized to issue these commands. This is also referred to as command authorization.

Wildcards and Regex in Command Sets

A command line comprises the command and zero or more arguments. When Cisco ISE receives a command line (request), it handles the command and its arguments in different ways:

- It matches the command in the request with the commands specified in the command set list using the wildcard matching paradigm.

Example: Sh?? or S*

- It matches the arguments in the request with the arguments specified in the command set list using regular expressions (regex) matching paradigm.

Example: Show interface[1-4] port[1-9];tty*

Command Line and Command Set List Match

To match a requested command line to a command set list containing wildcards and regex:

1. Iterate over a command set list to detect matching commands.

Wildcard matching permits:

- Case insensitivity
- Any character in the command in the command set may be "?", which matches any individual character that must exist in the requested command
- Any character in the command in the command set may be "*", which matches zero or more characters in the requested command

Examples:

Request	Command Set	Matches	Comments
show	show	Y	—
show	SHOW	Y	Case insensitive
show	Sh??	Y	Matches any character
show	Sho??	N	Second "?" intersects with the character that does not exist

Request	Command Set	Matches	Comments
show	S*	Y	"*" matches any character
show	S*w	Y	"*" matches characters "ho"
show	S*p	N	Character "p" does not correspond

- For each matching command, Cisco ISE validates the arguments.

The command set list will include a space-delimited set of arguments for each command.

Example: Show interface[1-4] port[1-9]:tty.*

This command has two arguments.

- Argument 1: interface[1-4]
- Argument 2: port[1-9]:tty.*

The command arguments in the request are taken in the position-significant order they appear in the packet. If all the arguments in the command definition match the arguments in the request, then this command/argument is said to be matched. Note that any extraneous arguments in the request are ignored.



Note Use the standard Unix regular expressions in arguments.

Process Rules with Multiple Command Sets

- If a command set contains a match for the command and its arguments, and the match has Deny Always, Cisco ISE designates the command set as Commandset-DenyAlways.
- If there is no Deny Always for a command match in a command set, Cisco ISE checks all the commands in the command set sequentially for the first match.
 - If the first match has Permit, Cisco ISE designates the command set as Commandset-Permit.
 - If the first match has Deny, Cisco ISE designates the command set as Commandset-Deny.
- After Cisco ISE has analyzed all the command sets, it authorizes the command:
 - If Cisco ISE designated any command set as Commandset-DenyAlways, Cisco ISE denies the command.
 - If there is no Commandset-DenyAlways, Cisco ISE permits the command if any command set is Commandset-Permit; otherwise, Cisco ISE denies the command. The only exception is when the **Unmatched** check box is checked.

TACACS+ Profile

TACACS+ profiles control the initial login session of the device administrator. A session refers to each individual authentication, authorization, or accounting request. A session authorization request to a network device elicits a Cisco ISE response. The response includes a token that is interpreted by the network device, which limits the commands that may be executed for the duration of a session. The authorization policy for a device administration access service can contain a single shell profile and multiple command sets. The TACACS+ profile definitions are split into two components:

- Common tasks
- Custom attributes

There are two views in the TACACS+ Profiles window (**Work Centers > Device Administration > Policy Elements > Results > TACACS Profiles**), **Task Attribute View** and **Raw View**. Common tasks can be entered using the **Task Attribute View** and custom attributes can be created in the **Task Attribute View** as well as the **Raw View**.

The **Common Tasks** section allows you to select and configure the frequently used attributes for a profile. The attributes that are included here are those defined by the TACACS+ protocol draft specifications. However, the values can be used in the authorization of requests from other services. In the **Task Attribute View**, the Cisco ISE administrator can set the privileges that will be assigned to the device administrator. The common task types are:

- Shell
- WLC
- Nexus
- Generic

The **Custom Attributes** section allows you to configure additional attributes. It provides a list of attributes that are not recognized by the **Common Tasks** section. Each definition consists of the attribute name, an indication of whether the attribute is mandatory or optional, and the value for the attribute.



Note You can define a total of 24 task attributes for TACACS-enabled network devices. If you define more than 24 task attributes, none of them are sent to TACACS-enabled network devices.

In the **Raw View**, you can enter the mandatory attributes using an equal to (=) sign between the attribute name and its value and optional attributes are entered using an asterisk (*) between the attribute name and its value. The attributes entered in the **Raw View** section are reflected in the **Custom Attributes** section in the **Task Attribute View** and vice versa. The **Raw View** section is also used to copy and paste the attribute list (for example, another product's attribute list) from the clipboard onto Cisco ISE. Custom attributes can be defined for nonshell services.

Common Tasks Settings

Navigate to **Work Centers > Device Administration > Policy Elements > Results > TACACS Profiles > Add** to view the common tasks settings window. The Common Task Types are Shell, WLC, Nexus, and Generic.

Shell

The following options are available for the Cisco ISE administrator to set the device administrator's privileges.

Option	Description
Default Privilege	Enable the default (initial) privilege level for a device administrator for the shell authorization. Select any one of the following options: <ul style="list-style-type: none"> • Select values between 0 through 15. • Select the required Identity Store Attribute.
Maximum Privilege	Enable the maximum privilege level for Enable authentication. You can select values between 0 through 15.
Access Control List	Select an ASCII String (1-251*) or the required Identity Store Attribute.
Auto Command	Select an ASCII String (1-248*) or the required Identity Store Attribute.
No Escape	Select any one of the following options for escape characters: <ul style="list-style-type: none"> • True: Specifies that escape prevention is enabled. • False: Specifies that escape prevention is not enabled. • Select the required Identity Store Attribute.
Timeout	Select values between 0 through 9999 or the required Identity Store Attribute.
Idle Time	Select values between 0 through 9999 or the required Identity Store Attribute.

WLC

The following options are available for the Cisco ISE administrator to control a device administrator's access to the WLC application tabs. The WLC application contains the following tabs: WLAN, Controller, Wireless, Security, Management, and Commands.

Option	Description
All	Device administrators have full access to all the WLC application tabs.
Monitor	Device administrators have only read-only access to the WLC application tabs.

Option	Description
Lobby	Device administrators have only limited configuration privileges.
Selected	Device administrators have access to the tabs as checked by the Cisco ISE administrator from the following check boxes: WLAN, Controller, Wireless, Security, Management, and Commands.

Nexus

The following options are available for the Cisco ISE administrator to control a device administrator's access to the Cisco Nexus switches.

Option	Description
Set Attribute As	A Cisco ISE administrator can specify the Nexus attributes generated by the common tasks as Optional or Mandatory.
Network Role	When a Nexus is configured to authenticate using Cisco ISE, the device administrator, by default, has read-only access. Device administrators can be assigned to one of these roles. Each role defines the operations that is allowed: <ul style="list-style-type: none"> • None: No privileges. • Operator (Read Only): Complete read access to the entire NX-OS device. • Administrator (Read/Write): Complete read-and-write access to the entire NX-OS device.
Virtual Device Context (VDC)	None: No privileges. Operator (Read Only): Read access limited to a VDC Administrator (Read/Write): Read-and-write access limited to a VDC.

Generic

The Cisco ISE administrator uses the option to specify custom attributes that are not available in the common tasks.

Create TACACS+ Command Sets

To create a policy set using the TACACS+ command sets policy results:

-
- Step 1** Choose **Work Centers > Device Administration > Policy Results > TACACS Command Sets**.
- Step 2** You can also configure TACACS command sets in the **Work Centers > Device Administration > Device Admin Policy Sets** page.
- Step 3** Click **Add**.
- Step 4** Enter a name and description.
- Step 5** Click **Add** to specify the Grant permission, Command, and Argument.
- Step 6** In the **Grant** drop-down, you can choose one of the following:
- **Permit:** To allow the specified command, (for example, permit show, permit con* Argument terminal).
 - **Deny:** To deny the specified command, (for example, deny mtrace).
 - **Deny Always:** To override a command that has been permitted in any other command set, (for example, clear auditlogs)
- Note** Click the action icon to increase or decrease the column width of the Grant, Command, and Argument fields.
- Step 7** Check the **Permit any command that is not listed below** check box to allow commands and arguments that are not specified as Permit, Deny or Deny Always in the Grant column.
-

Create TACACS+ Profiles

To create a TACACS+ profile:

-
- Step 1** Choose **Work Centers > Device Administration > Policy Elements > Results > TACACS Profiles**.
- Step 2** Click **Add**.
- Step 3** In the **TACACS Profile** section, enter a name and description.
- Step 4** In the **Task Attribute View** tab, check the required **Common Tasks**. Refer to the [Common Tasks Settings, on page 207](#) page.
- Step 5** In the **Task Attribute View** tab, in the **Custom Attributes** section, click **Add** to enter the required attributes.
-

Create Device Administration Policy Sets

To create a device administration policy set:

Before you begin

- Ensure that the **Enable Device Admin Service** checkbox in the **Administration > System > Deployment > Edit Node > General Settings** window is enabled for TACACS+ operations.



Note It is recommended to enable Device Administration in the **Work Centers > Device Administration > Overview > Deployment** window.

- Ensure that the User Identity Group, (for example, System_Admin, Helpdesk) is created. (**Work Centers > Device Administration > User Identity Groups** window)
- Ensure that the member users (for example, ABC, XYZ) is included in the User Identity Group. (**Work Centers > Device Administration > Identities > Users** window)
- Ensure to configure TACACS settings on devices that need to be administered. (**Work Centers > Device Administration > Network Resources > Network Devices > Add > TACACS Authentication Settings** check box is enabled and the shared secret for TACACS and devices are identical to facilitate the devices to query Cisco ISE.)
- Ensure that the Network Device Group, based on the Device Type and Location, is created. (**Work Centers > Device Administration > Network Device Groups** window)

Step 1 Choose **Work Centers > Device Administration > Device Admin Policy Sets**.

Step 2 In the left pane, select a current policy set above (below) which the new policy set is to be added.

Step 3 In the left pane, click **Create Above** to create a new policy set.

Step 4 Click **Edit** and enter the Name, Description, and Condition, (for example, Name: Device_Admin_Policy_1, Description: ISE administrator, Conditions: DEVICE:Device Type EQUALS Device Type#All Device Types #Cisco_switches) to configure the rules based on the condition.

Step 5 Click **Done**.

Step 6 Create the required Authentication policy, (for example, Name: ATN_Internal_Users, Rule: if DEVICE:Location EQUALS Location #All Locations#Europe, Condition: Allow Protocols: Device_Admin_protocols and Default: Use Internal Users—The policy matches only devices that are in location Europe, allows protocols that are defined under device admin protocols, and authenticates against the internal users).

Step 7 Create the required Authorization Policy.

Example 1: Rule Name: Sys_Admin_rule, Conditions: if SysAdmin and TACACS User Equals ABC then cmd_Sys_Admin AND Profile_priv_8—The policy matches system administrators with user name ABC and allows the specified commands to be executed and assigns a privilege level of 8.

Example 2: Rule Name: HelpDesk AND TACACS User EQUALS XYZ then cmd_HDesk_show AND cmd_HDesk_ping AND Profile_priv_1—The policy matches system administrators with user name XYZ and allows the specified commands to be executed and assigns a privilege level of 1.

In the above examples:

- The command sets, cmd_Sys_Admin and cmd_HDesk, are created in the **Work Centers > Device Administration > Policy Elements > Results > TACACS Command Sets > Add** window.
- The TACACS profiles, Profile_Priv_1 and Profile_priv_8, are created in the **Work Centers > Device Administration > Policy Elements > Results > TACACS Profiles > Add** window.

Note It is recommended that the policy results are created prior to the creation of the policy set such that it will be readily available when creating the authorization results.

Step 8 Click **Submit** to create the new policy set.

Monitor Device Administration Activity

Cisco ISE provides various reports and logs that allow you to view information related to accounting, authentication, authorization, and command accounting of devices configured with TACACS+. You can run these reports either on demand or on a scheduled basis.

Step 1 Choose **Work Centers > Device Administration > Reports > ISE Reports**.

You can also view the reports in the **Operations > Reports > ISE Reports** page.

Step 2 In the **Report Selector**, expand **Device Administration** to view **TACACS Accounting**, **TACACS Authentication**, **TACACS Authorization** and reports.

Step 3 Select the report and choose the data with which you want to search using the **Filters** drop-down list.

Step 4 Select the **Time Range** during which you want to view the data.

Step 5 Click **Run**.

Configure Global TACACS+ Settings

To configure global TACACS+ settings:

Step 1 Choose **Work Centers > Device Administration > Settings**.

In the **Connection Settings** tab, you can change the default values for the required fields.

- **Single Connect Support:** If you disable Single Connect Mode, ISE uses a new TCP connection for every TACACS+ request.

Step 2 In the **Password Change Control** tab, define the required fields to control whether password update is permitted through TACACS+.

The prompts in the **Enable Telnet Change Password** section are enabled only when this option is selected. Or else, the prompts in the **Disable Telnet Change Password** are enabled. The password prompts are fully customizable and can be modified as needed.

Step 3 In the **Session Key Assignment** tab, select the required fields to link TACACS+ requests into a session.

The session key is used by the Monitoring node to link AAA requests from clients. The default settings are for NAS-Address, Port, Remote-Address, and User fields to be enabled.

Step 4 Click **Save**.

Related Topics

[TACACS+ Authentication Settings and Shared Secret](#), on page 203



CHAPTER 10

Manage Network Devices

- [Defining Network Devices in Cisco ISE, on page 213](#)
- [Support for Session Aware Networking \(SANet\), on page 214](#)
- [Define a Default Network Device in Cisco ISE, on page 215](#)
- [Add a Network Device in Cisco ISE, on page 215](#)
- [Import Network Devices into Cisco ISE, on page 216](#)
- [Export Network Devices from Cisco ISE, on page 216](#)
- [Third-Party Network Device Support in Cisco ISE, on page 217](#)
- [Network Device Groups, on page 224](#)
- [Import Network Device Groups into Cisco ISE, on page 226](#)
- [Export Network Device Groups from Cisco ISE, on page 226](#)
- [Import Templates in Cisco ISE, on page 226](#)
- [IPsec Security to Secure Communication Between Cisco ISE and NAD, on page 231](#)
- [Mobile Device Manager Interoperability with Cisco ISE, on page 241](#)
- [Set Up Mobile Device Management Servers with Cisco ISE, on page 248](#)

Defining Network Devices in Cisco ISE

A network device, such as a switch or a router, is an authentication, authorization, and accounting (AAA) client through which AAA service requests are sent to Cisco ISE. Defining network devices in Cisco ISE enables interactions between Cisco ISE and network devices.

Configure network devices for RADIUS or TACACS AAA, and Simple Network Management Protocol (SNMP) for the Profiling service to collect Cisco Discovery Protocol and Link Layer Discovery Protocol (LLDP) attributes for profiling endpoints, and TrustSec attributes for Cisco TrustSec devices. A network device that is not defined in Cisco ISE cannot receive AAA services from Cisco ISE.

From the Cisco ISE main menu, choose **Administration > Network Resources > Network Devices**, and click **Add**. In the **New Network Device** window that is displayed, enter the following details to define a network device:

- Select the vendor profile that fits the network device. The profile includes predefined configurations for the device, such as settings for URL redirect and change of authorization.
- Configure the RADIUS protocol for RADIUS authentications. When Cisco ISE receives a RADIUS request from a network device, it looks for the corresponding device definition to retrieve the configured shared secret. If Cisco ISE finds the device definition, it obtains the configured shared secret on the

device and matches it against the shared secret in the request to authenticate access. If the shared secrets match, the RADIUS server processes the request further based on the policy and configuration. If the shared secrets do not match, a reject response is sent to the network device. A failed authentication report is generated, which provides the failure reason.

- Configure the TACACS+ protocol for TACACS+ authentications. When Cisco ISE receives a TACACS+ request from a network device, it looks for the corresponding device definition to retrieve the shared secret that is configured. If it finds the device definition, it obtains the shared secret that is configured on the device and matches it against the shared secret in the request to authenticate access. If the shared secrets match, the TACACS+ server processes the request further based on the policy and configuration. If they do not match, a reject response is sent to the network device. A failed authentication report is generated, which provides the failure reason.
- You can configure the Simple Network Management Protocol (SNMP) in the network device definition for the Profiling service to communicate with the network devices and profile endpoints that are connected to the network devices.
- You must define Cisco TrustSec-enabled devices in Cisco ISE to process requests from TrustSec-enabled devices that can be part of the Cisco TrustSec solution. Any switch that supports the Cisco TrustSec solution is a Cisco TrustSec-enabled device.

Cisco TrustSec devices do not use IP addresses. Instead, you must define other settings so that Cisco TrustSec devices can communicate with Cisco ISE.

Cisco TrustSec-enabled devices use the TrustSec attributes to communicate with Cisco ISE. Cisco TrustSec-enabled devices, such as the Cisco Nexus 7000 Series Switches, Cisco Catalyst 6000 Series Switches, Cisco Catalyst 4000 Series Switches, and Cisco Catalyst 3000 Series Switches are authenticated using the Cisco TrustSec attributes that you define while adding Cisco TrustSec devices.



Note When you configure a network device on Cisco ISE, we recommend that you do not include a backslash (\) as part of the shared secret. This is because when you upgrade Cisco ISE, the backslash will not appear in the shared secret. However, if you reimage Cisco ISE instead of upgrading it, the backslash appears in the shared secret.

Support for Session Aware Networking (SAnet)

Cisco ISE provides limited support for Session Aware Networking (SAnet). SAnet is a session management framework that runs on many Cisco switches. SAnet manages access sessions, including visibility, authentication, and authorization. SAnet uses a service template, which contains RADIUS authorization attributes. Cisco ISE includes a service template inside an authorization profile. Cisco ISE identifies service templates in an authorization profile using a flag that identifies the profile as “Service Template” compatible.

Cisco ISE authorization profiles contain RADIUS authorization attributes that are transformed into a list of attributes. SAnet service templates also contain of RADIUS authorization attributes, but those attributes are not transformed into a list.

For SAnet devices, Cisco ISE sends the name of the service template. The device downloads the content of the service template, unless it already has that content in a cache or statically defined configuration. Cisco ISE sends a CoA notification to the device when a service template changes RADIUS attributes.

Define a Default Network Device in Cisco ISE

Cisco ISE supports the default device definition for RADIUS and TACACS authentications. You can define a default network device that Cisco ISE can use if it does not find a device definition for a particular IP address. This feature enables you to define a default RADIUS or TACACS shared secret and the level of access for newly provisioned devices.



Note We recommend that you add the default device definition only for basic RADIUS and TACACS authentications. For advanced flows, you must add a separate device definition for each network device.

Cisco ISE looks for the corresponding device definition to retrieve the shared secret that is configured in the network device definition when it receives a RADIUS or TACACS request from a network device.

Cisco ISE performs the following procedure when a RADIUS or TACACS request is received:

1. Looks for a specific IP address that matches the one in the request.
2. Looks up the ranges to see if the IP address in the request falls within the range that is specified.
3. If both step 1 and 2 fail, it uses the default device definition (if defined) to process the request.

Cisco ISE obtains the shared secret that is configured in the device definition for that device and matches it against the shared secret in the RADIUS or TACACS request to authenticate access. If no device definitions are found, Cisco ISE obtains the shared secret from the default network device definition and processes the RADIUS or TACACS request.

Add a Network Device in Cisco ISE

You can add a network device in Cisco ISE or use the default network device.

You can also add a network device in the **Network Devices (Work Centers > Device Administration > Network Resources > Network Devices)** window.

Before you begin

The AAA function must be enabled on the network device to be added. See [Command to Enable AAA Functions, on page 1178](#).

-
- Step 1** Choose **Administration > Network Resources > Network Devices**.
 - Step 2** Click **Add**.
 - Step 3** Enter the corresponding values in the **Name**, **Description**, and **IP Address** fields.
 - Step 4** Choose the required values from the **Device Profile**, **Model Name**, **Software Version**, and **Network Device Group** drop-down lists.
 - Step 5** (Optional) Check the **RADIUS Authentication Settings** check box to configure the RADIUS protocol for authentication.
 - Step 6** (Optional) Check the **TACACS Authentication Settings** check box to configure the TACACS protocol for authentication.
 - Step 7** (Optional) Check the **SNMP Settings** check box to configure SNMP for the Cisco ISE profiling service to collect information from the network device.

- Step 8** (Optional) Check the **Advanced Trustsec Settings** check box to configure a Cisco TrustSec-enabled device.
- Step 9** Click **Submit**.
-

Import Network Devices into Cisco ISE

To enable Cisco ISE to communicate with network devices, you must add device definitions of the network devices in Cisco ISE. Import device definitions of network devices into Cisco ISE through the **Network Devices** window (From the main menu, choose **Administration** > **Network Resources** > **Network Devices**).

Import a list of device definitions into a Cisco ISE node using a comma-separated value (CSV) file. A CSV template file is available when you click **Import** in the **Network Devices** window. Download this file, enter the required device definitions, and then upload the edited file through the **Import** window.

You cannot execute multiple imports of the same resource type at the same time. For example, you cannot concurrently import network devices from two different import files.

When you import a CSV file of device definitions, you can either create new records or update existing records by clicking the **Overwrite Existing Data with New Data** option.

Import templates may vary in each Cisco ISE. Do not import CSV files of network devices that have exported from a different Cisco ISE release. Enter the details of the network devices in the CSV template file for your release, and import this file into Cisco ISE.

- Step 1** Choose **Administration** > **Network Resources** > **Network Devices**.
- Step 2** Click **Import**.
- Step 3** Click **Browse** to choose the CSV file from the system that is running the client browser.
- Step 4** (Optional) Check the for **Overwrite Existing Data with New Data** and **Stop Import on First Error** check boxes, as required.
- Step 5** Click **Import**.
- After the file import is complete, Cisco ISE displays a summary message. This message includes the import status (successful or unsuccessful), number of errors encountered, if any, and the total processing time taken for the file import process.
-

Export Network Devices from Cisco ISE

You can export the device definitions of the network devices that are available in a Cisco ISE node in the form of a CSV file. You can then import this CSV file into another Cisco ISE node so that the device definitions are available to the required Cisco ISE nodes.

- Step 1** Choose **Administration** > **Network Resources** > **Network Devices**.
- Step 2** Click **Export**.
- Step 3** Export the device definitions for the network devices added to the Cisco ISE node by performing one of the following actions.

- Check the check boxes next to the devices that you want to export, choose **Export Selected** from the **Export** drop-down list.
- Choose **Export All** from the **Export** drop-down list to export all the network devices that are added to the Cisco ISE node.

Step 4 In both cases, a CSV file of device definitions is downloaded to your system.

Third-Party Network Device Support in Cisco ISE

Cisco ISE supports third-party network access devices (NADs) by using network device profiles. A NAD profile defines the capabilities of a third-party device with a simplified policy configuration, regardless of the vendor-side implementation. A network device profile contains the following:

- The protocols that the network device supports, such as RADIUS, TACACS+, and Cisco TrustSec. You can import into Cisco ISE any vendor-specific RADIUS dictionaries that exist for the network device.
- The attributes and values that the device uses for various authentication flows such as Wired MAB and 802.1X. These attributes and values allow Cisco ISE to detect the right authentication flow for your device according to the attributes that the network device uses.
- The Change of Authorization (CoA) capabilities of the network device. While the RADIUS protocol RFC 5176 defines a CoA request, the attributes used in a CoA request vary depending on the network device. Most non-Cisco devices with RFC 5176 support will support the *Push* and *Disconnect* functions. For devices that do not support the RADIUS CoA type, Cisco ISE also supports SNMP CoA.
- The attributes and protocols that the network device uses for MAB flows. Network devices from different vendors perform MAB authentication differently.
- The VLAN and ACL permissions that are used by the device. When you save the profile, Cisco ISE automatically generates authorization profiles for each configured permission.
- URL redirection technique information. URL redirection is necessary for advanced flows such as Bring Your Own Device (BYOD), guest access, and posture services. Two types of URL redirections are found on a network device—static and dynamic. For static URL redirection, you can copy and paste the Cisco ISE portal URL into the configuration. For dynamic URL redirection, Cisco ISE uses a RADIUS attribute to tell the network device where to redirect to.

If the network device does not support both dynamic and static URL redirects, Cisco ISE provides an Auth VLAN configuration by which URL redirect is simulated. The Auth VLAN configuration is based on DHCP and DNS services running in Cisco ISE.

After you have defined your network devices in Cisco ISE, configure these device profiles or use the preconfigured device profiles that are offered by Cisco ISE in order to define the capabilities that Cisco ISE uses to enable basic authentication flows, and advanced flows such as Profiler, Guest, BYOD, MAB, and Posture.

URL Redirect Mechanism and Auth VLAN

When a third-party device is used in the network and the device does not support dynamic or static URL redirect, Cisco ISE simulates the URL redirect flow. The URL redirect simulation flow for such devices is operated by running a DHCP or DNS service on Cisco ISE.

The following is an example of an Auth VLAN flow:

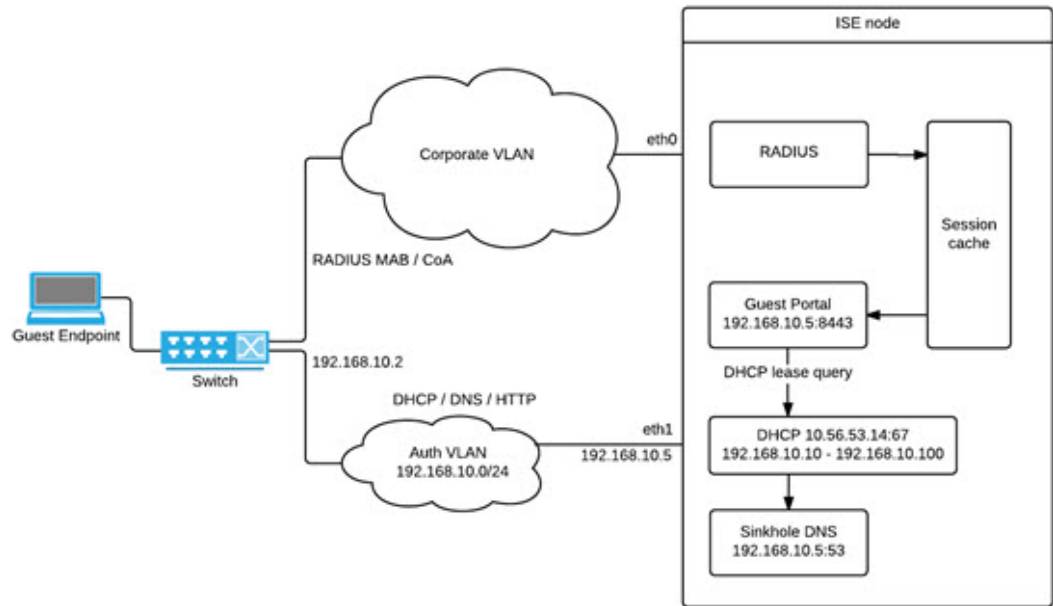
1. A guest endpoint connects to the NAD.
2. The network device sends the RADIUS or MAB request to Cisco ISE.
3. Cisco ISE runs the configured authentication and authorization policy and stores the user accounting information.
4. Cisco ISE sends the RADIUS access accept message that contains the Auth VLAN ID.
5. The guest endpoint receives network access.
6. The endpoint broadcasts a DHCP request, and obtains a client IP address and the Cisco ISE DNS sinkhole IP address from the Cisco ISE DHCP service.
7. The guest endpoint opens a browser that sends a DNS query and receives the Cisco ISE IP address.
8. The endpoint HTTP and HTTPS requests are directed to Cisco ISE.
9. Cisco ISE responds with an **HTTP 301 Moved** message with a guest portal URL. The endpoint browser redirects to the guest portal window.
10. The guest endpoint user logs in for authentication.
11. Cisco ISE validates endpoint compliance and then responds to the NAD. Cisco ISE sends the CoA, authorizes the endpoint, and bypasses the sinkhole.
12. The guest user receives the appropriate access based on the CoA, and the endpoint receives an IP address from an enterprise DHCP. The guest user can now use the network.

You can separate the Auth VLAN from the corporate network to prevent unauthorized network access by a guest endpoint before the endpoint passes authentication. Configure the Auth VLAN IP helper to point to the Cisco ISE machine, or connect one of the Cisco ISE network interfaces to the Auth VLAN.

Multiple VLANs may be connected to one network interface card by configuring a VLAN IP helper from the NAD configuration. For more information about configuring an IP helper, see the administration guide for the network device for instructions. For guest access flows that include VLANs with IP helpers, define a guest portal, and select that portal in an authorization profile that is bound to MAB authorization. For more information about guest portals, see [Cisco ISE Guest Services, on page 441](#).

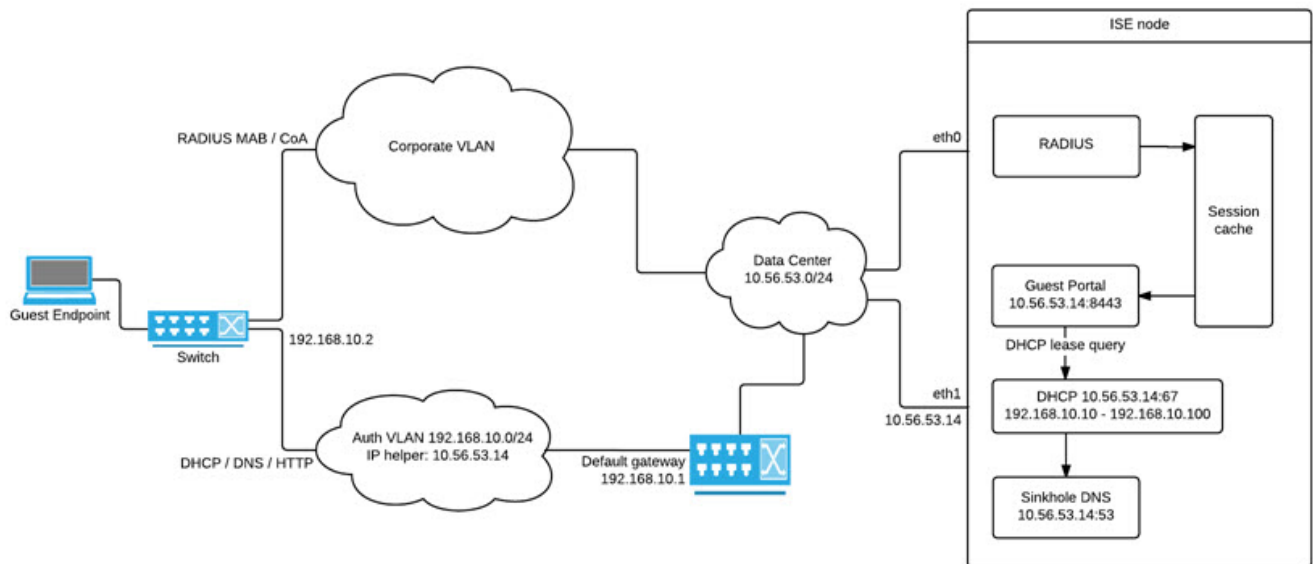
The following diagram displays a basic network setup when an Auth VLAN is defined (the Auth VLAN is connected directly to a Cisco ISE node).

Figure 17: Auth VLAN Connected to Cisco ISE Node



The following diagram displays a network with Auth VLAN and an IP helper.

Figure 18: Auth VLAN Configured with IP Helper



CoA Types

Cisco ISE supports both RADIUS and SNMP CoA types. RADIUS or SNMP CoA type support is required for the NAD to work in complex flows, while it is not mandatory for basic flows.

Define the RADIUS and SNMP settings that are supported by the network device when configuring the NAD in Cisco ISE, and indicate the CoA type to be used for a specific flow when configuring the NAD profile. For more information about defining protocols for your NADs, see [Network Device Definition Settings, on page 1022](#). Check with your third-party supplier to verify which CoA type your NAD supports before creating the device profile and NAD profile in Cisco ISE.

Network Device Profiles

Cisco ISE supports some third-party NADs by using network device profiles. These profiles define the capabilities that Cisco ISE uses to enable basic flows, and advanced flows such as Guest, BYOD, MAB, and Posture.

Cisco ISE includes predefined profiles for network devices from several vendors. Cisco ISE 2.1 and later releases have been tested with the network devices listed in the following table.

Table 11: Vendor Devices Tested with Cisco ISE 2.1 and Later Releases

Device Type	Vendor	CoA Type	URL Redirect Type	Supported or Validated Use Cases				
				802.1X and MAB Flows	Profiler without CoA	Profiler with CoA	Posture	Guest and BYOD Flows
Wireless	Aruba 7000, InstantAP	RADIUS	Static URL	Yes	Yes	Yes	Yes	Yes
	Motorola RFS 4000	RADIUS	Dynamic URL	Yes	Yes	Yes	Yes	Yes
	HP 830	RADIUS	Static URL	Yes	Yes	Yes	Yes	Yes
	Ruckus ZD 1200	RADIUS	—	Yes	Yes	Yes	Yes	Yes

Wired	HP A5500	RADIUS	Auth VLAN provided by ISE	Yes	Yes	Yes	Yes	Yes
	HP 3800 and 2920 (ProCurve)	RADIUS	Auth VLAN provided by ISE	Yes	Yes	Yes	Yes	Yes
	Alcatel 6850	SNMP	Dynamic URL	Yes	Yes	Yes	Yes	Yes
	Brocade ICX 6610	RADIUS	Auth VLAN provided by ISE	Yes	Yes	Yes	Yes	Yes
	Juniper EX3300-24p	RADIUS	Auth VLAN provided by ISE	Yes	Yes	Yes	Yes	Yes
For other third-party NADs, you must identify the device properties and capabilities, and create custom NAD profiles in Cisco ISE.				Yes	Yes	Requires CoA support	Requires CoA support. If a wired device does not support URL redirect, Cisco ISE utilizes Auth VLAN. Wireless devices have not been tested with Auth VLAN.	

You must create custom NAD profiles for other third-party network devices that do not have a predefined profile. For advanced workflows such as Guest, BYOD, and Posture, the network device must support the RADIUS protocol RFC 5176, which pertains to CoA support for these flows. See the device's administration guide for information on the attributes that are required to create network device profiles in Cisco ISE.

If you upgrade from Cisco ISE Release 2.0 or earlier to Cisco ISE Release 2.1 or later, the authentication policy rules and RADIUS dictionaries created in the earlier release to communicate with non-Cisco NADs will continue to work in Cisco ISE after the upgrade.

[ISE Community Resource](#)

For information about third-party NAD profiles, see [ISE Third-Party NAD Profiles and Configs](#).

Configure a Third-Party Network Device in Cisco ISE

Cisco ISE supports third-party NADs by using network device profiles. These profiles define the capabilities that Cisco ISE uses to enable flows such as Guest, BYOD, MAB, and Posture.

Before you begin

See [Network Device Profiles](#), on page 220.

-
- Step 1** Add the third-party network device to Cisco ISE (See [Import Network Devices into Cisco ISE](#), on page 216. If you are configuring Guest, BYOD, or Posture workflows, ensure that CoA is defined and the NAD's URL redirect mechanism is configured to point to the relevant Cisco ISE portal. To configure the URL redirect, copy the Cisco ISE portal URL from the portal's landing page. For more information about configuring CoA types and URL redirects for the NAD in Cisco ISE, see [Network Device Definition Settings](#), on page 1022. In addition, see the third party device's administration guide for instructions.
- Step 2** Ensure that an appropriate NAD profile for your device is available in Cisco ISE. To view the existing profiles, choose **Administration > Network Resources > Network Device Profiles**. If an appropriate profile does not exist in Cisco ISE, create a custom profile. See [Create a Network Device Profile](#), on page 222 for information on how to create custom profiles.
- Step 3** Assign a NAD profile to the NAD that you want to configure. Choose **Administration > Network Resources > Network Devices**. Open the device to which you want to assign a profile, and from the **Device Profile** drop-down list, choose the profile that you want to assign.
- Step 4** When you configure your policy rules, the authorization profile should be explicitly set to the NAD profile in step 1, or **Any** if you are just using VLAN or ACL, or if you have different devices from different vendors in your network. To set the NAD profile for the authorization profile, choose **Policy > Policy Elements > Results > Authorization > Authorization Profiles**. Open the relevant authorization profile and from **Network Device Profile** drop-down list, choose the relevant NAD profile. When using Auth VLAN for Guest flows, you should also define a guest portal and select that portal in an Authorization profile that is bound to MAB authorization—similar to regular Guest flows. For more information about guest portals, see the "Cisco ISE Guest Services" section in see [Cisco ISE Guest Services](#), on page 441.
-

Create a Network Device Profile

Before you begin

- Most NADs have a vendor-specific RADIUS dictionary that provides several vendor-specific attributes, apart from the standard IETF RADIUS attributes. If the network device has a vendor-specific RADIUS dictionary, import it into Cisco ISE. See the third-party device's administration guide for instructions on which RADIUS dictionary is required. In Cisco ISE, choose **Policy > Policy Elements > Dictionaries > System > Radius > RADIUS Vendors**. To import RADIUS dictionaries, see [Create RADIUS-Vendor Dictionaries](#), on page 266.
- For complex flows such as Guest and Posture, the network device must support the CoA types that are defined in RFC 5176
- For information about the fields and possible values for creating a network device profile, see [Network Device Profiles Settings](#), on page 1038.

-
- Step 1** Choose **Administration > Network Resources > Network Device Profiles**.
- Step 2** Click **Add**.
- Step 3** In the **New Network Device Profile** window that is displayed, enter the corresponding values in the **Name** and **Description** fields for the network device.

- Step 4** From the **Vendor** drop-down list, choose the vendor of the network device.
- Step 5** In the **Icon** area, click **Change Icon...** to upload an icon for the network device from your system.
Alternatively, in the **Icon** area, click **Set To Default** to use the default icon provided by Cisco ISE.
- Step 6** In the **Supported Protocols** area, check the check boxes for the protocols that the device supports. Check the check boxes only for the protocols you want to actually use. If the network device supports the RADIUS protocol, choose the RADIUS dictionary to be used in the device from **RADIUS Dictionaries** drop-down list.
- Step 7** In the **Templates** area, enter relevant details:
- Click **Authentication/Authorization** to configure the network device's default settings for flow types, attribute aliasing, and host lookup. In the new **Flow Type Conditions** area that is displayed, enter the attributes and values that your device uses for various authentication and authorization flows such as Wired MAB or 802.1X. This enables Cisco ISE to detect the correct flow type for your device according to the attributes it uses. There is no IETF standard for MAB, and different vendors use different values for Service Type. See the device's user guide or use a sniffer trace of a MAB authentication to determine the correct settings. In the **Attribute Aliasing** area, map device-specific attribute names to common names to simplify policy rules. Currently, only the Service Set Identifier (SSID) is defined. If the network device has the concept of wireless SSID, then set this to the attribute it uses. Cisco ISE maps this to an attribute called SSID in the Normalized RADIUS dictionary. This simplifies policy rule configuration because you can refer to SSID in one rule, and it works for multiple devices even if the underlying attributes are different. In the **Host Lookup** area, check the **Process Host Lookup** check box and select the relevant MAB protocols and attributes for your device, based on the instructions provided by the third-party device vendor.
 - Click **Permissions** to configure the network device's default settings for VLAN and ACL. These are automatically mapped based on the authorization profiles you create in Cisco ISE.
 - Click **Change of Authorization (CoA)** to configure the network device's CoA capabilities .
 - Click **Redirect** to configure the network device's URL-redirect capabilities. URL redirection is necessary for guest, BYOD, and posture services.
- Step 8** Click **Submit**.

Related Topics

[How to Create ISE Network Access Device Profiles](#)

Export Network Device Profiles from Cisco ISE

Export single or multiple network device profiles that are configured in Cisco ISE in the form of an XML file. The XML file can then be edited and imported into Cisco ISE file as new network profiles.

Before you begin

See [How to Create ISE Network Access Device Profiles](#).

-
- Step 1** Choose **Administration** > **Network Resources** > **Network Device Profiles**.
- Step 2** Check the check boxes next to the devices that you want to export, and click **Export Selected**.
- Step 3** A file named **DeviceProfiles.xml** downloads to your local hard disk.
-

Import Network Device Profiles into Cisco ISE

Import a single or multiple network device profiles into Cisco ISE using a single XML file with the Cisco ISE XML structure. Note that you cannot concurrently import network device profiles from multiple import files.

Typically, you should first export an existing profile from the Cisco ISE administrator portal to use as a template. Enter your device profile details in the file, and save it as an XML file. Then, import the edited file back into Cisco ISE. To work with multiple network device profiles, export multiple profiles that are structured together as a single XML file, edit the file, and then import the profiles together to create multiple profiles in Cisco ISE.

When you import network device profiles, you can only create new records. You cannot overwrite an existing profile. To update an existing network device profile, export the existing profile from Cisco ISE, delete the profile from Cisco ISE, and then import the profile after you edit it accordingly.

Before you begin

See [How to Create ISE Network Access Device Profiles](#).

-
- Step 1** Choose **Administration > Network Resources > Network Device Profiles**.
- Step 2** Click **Import**.
- Step 3** Click **Browse** to choose the XML file from the system that is running the client browser.
- Step 4** Click **Import**.
-

Network Device Groups

Cisco ISE allows you to create hierarchical network device groups. Use network device groups to logically group network devices based on various criteria, such as geographic location, device type, or its relative place in the network (such as Access Layer or Data Center).

To view the Network Device Groups window, choose **Administration > Network Resources > Network Device Groups**.

For example, to organize your network devices based on geographic location, group them by continent, region, or country:

- **Africa > Southern > Namibia**
- **Africa > Southern > South Africa**
- **Africa > Southern > Botswana**

Group the network devices based on the device type:

- **Africa > Southern > Botswana > Firewalls**
- **Africa > Southern > Botswana > Routers**
- **Africa > Southern > Botswana > Switches**

Assign network devices to one or more hierarchical network device groups. When Cisco ISE processes the ordered list of configured network device groups to determine the appropriate group to assign to a particular device, it may find that the same device profile applies to multiple device groups. In this case, Cisco ISE will apply the first device group that is matched.

There is no limit on the maximum number of network device groups that can be created. There is no restriction on the maximum number of hierarchy levels.

The device group hierarchy is displayed in two views, **Tree Table** and **Flat Table**. Click **Tree Table** or **Flat Table** above the list of network device groups to organize the list into the corresponding view.

In the **Tree Table** view, the root node appears at the top of the tree followed by the child groups in hierarchical order. Click **Expand All** to view all the device groups in each root group. Click **Collapse All** to view a list of only the root groups.

In the **Flat Table** view, the hierarchy of each device group is displayed in the **Group Hierarchy** column.

In both views, the number of network devices that are assigned to each child group is displayed in the corresponding **No. of Network Devices** column. Click the number to launch a dialog box that lists all the network devices that are assigned to that device group. The dialog box that is displayed also contains two buttons to move network devices from one group to another. Click **Move Devices to Another Group** to move network devices from the current group to another. Click **Add Devices to Group** to move a network device into the chosen network device group.

To add a network device group in the **Network Device Groups** window, click **Add**. In the **Parent Group** drop-down list, choose the parent group to which the network device group must be added, or choose the **Add As Root Group** option to add the new network device group as the parent group.



Note You cannot delete a device group if any devices are assigned to that device group. Before deleting a device group, you must move all the existing devices to another device group.

Root Network Device Groups

Cisco ISE includes two predefined root network device groups, **All Device Types** and **All Locations**. You cannot edit, duplicate, or delete these predefined network device groups, but you can add new device groups under them.

You can create a root Network Device Group (network device group), and then create child network device groups under the root group in the **Network Device Groups** window, as described earlier.

Network Device Attributes Used by Cisco ISE in Policy Evaluation

When you create a new network device group, a new network device attribute is added to the **Device** dictionary in **System Dictionaries (Policy > Policy Elements > Dictionaries)**. The added device attributes are then used in policy definitions.

Cisco ISE allows you to configure authentication and authorization policies using **Device** dictionary attributes such as the device type, location, model name, or software version that is running on the network device.

Import Network Device Groups into Cisco ISE

You can import network device groups into a Cisco ISE node using a comma-separated value (CSV) file. Not that you cannot concurrently import network device groups from two different import files.

Download a CSV template from the Cisco ISE administrator portal, enter your network device group details in the template, save the template as a CSV file, and then import the edited file into Cisco ISE.

When importing device groups, you can create new records or update existing records. When you import device groups, you can also define whether you want Cisco ISE to overwrite the existing device groups with the new groups or stop the import process when Cisco ISE encounters the first error.

-
- Step 1** Choose **Administration > Network Resources > Network Device Groups**.
- Step 2** Click **Import**.
- Step 3** In the dialog box that is displayed, click **Browse** to choose the CSV file from the system that is running the client browser. To download a CSV template file for adding network device groups, click **Generate a Template**.
- Step 4** To overwrite the existing network device groups, check the **Overwrite Existing Data with New Data** check box.
- Step 5** Check the **Stop Import on First Error** check box.
- Step 6** Click **Import**.
-

Export Network Device Groups from Cisco ISE

You can export network device groups that are configured in Cisco ISE in the form of a CSV file. You can then import these network device groups into another Cisco ISE node.

-
- Step 1** Choose **Administration > Network Resources > Network Device Groups > All Groups**.
- Step 2** To export the network device groups, you can do one of the following:
- Check the check boxes next to the device groups that you want to export, and choose **Export > Export Selected**.
 - Choose **Export > Export All** to export all the network device groups that are defined.

A CSV file is downloaded into your local hard disk.

Import Templates in Cisco ISE

Cisco ISE allows you to import a large number of network devices and network device groups using CSV files. The template contains a header row that defines the format of the fields. You must not edit this header row.

Use the **Generate a Template** link in the relevant import flow for network devices and network device groups to download a CSV file in the Microsoft Office Excel application and save the file format locally on your system. When you click the Generate a Template link, the Cisco ISE server displays the Opening template.csv dialog. This dialog allows you to open the template.csv file and save the template.csv file locally on your system with an appropriate name for network devices and network device groups. If you choose to open the template.csv file from the dialog, the file opens in the Microsoft Office Excel application by default.

Network Devices Import Template Format

The following table lists and describes the fields in the header of the import network device CSV template file.

Table 12: CSV Template Fields and Descriptions for Network Devices

Field	Usage Guidelines
Name:String(32)	Enter a name for the network device. The name must be an alphanumeric string with a maximum of 32 characters.
Description:String(256)	(Optional) Enter a description for the network device with a maximum of 256 characters.
IP Address:Subnets(a.b.c.d/m ...)	Enter the IP address and subnet mask of the network device. You can enter more than one value separated by a pipe () symbol. IPv4 addresses are supported for network device (TACACS and RADIUS) configurations and for external RADIUS server configurations.
Model Name:String(32)	Enter the network device's model name with a maximum of 32 characters.
Software Version:String(32)	Enter the network device's software version with a maximum of 32 characters.
Network Device Groups:String(100)	Enter the names of existing network device groups. If it is a subgroup, it must include both the parent and subgroup separated by a space. The string must be a maximum of 100 characters, for example, <i>Location>All Location>US</i> .
Authentication:Protocol:String(6)	Enter the authentication protocol that you want to use. The only valid value is RADIUS (not case-sensitive).
Authentication:Shared Secret:String(128)	(Required only if you enter a value in the Authentication:Protocol:String(6) field) Enter a string with a maximum of 128 characters.
EnableKeyWrap:Boolean(true false)	This field is enabled only if KeyWrap is supported in the network device. You must enter true or false .

Field	Usage Guidelines
EncryptionKey:String(ascii:16 hexa:32)	(Required if you enable KeyWrap) Enter the encryption key that is used for session encryption. ASCII values: 16 characters (bytes) long. Hexadecimal values: 32 characters (bytes) long.
AuthenticationKey:String(ascii:20 hexa:40)	(Required if you enable KeyWrap.) Enter the keyed Hashed Message Authentication Code (HMAC) calculation over RADIUS messages. ASCII values: 20 characters (bytes) long. Hexadecimal values: 40 characters (bytes) long.
InputFormat:String(32)	Enter the encryption and authentication keys input format. ASCII and hexadecimal values are accepted.
SNMP:Version:Enumeration (2c 3)	Enter the version of the SNMP protocol that the profiler service must use—1, 2c, or 3.
SNMP:RO Community:String(32)	(Required if you enter a value in the SNMP:Version:Enumeration (2c 3) field). Enter a string for Read Only Community with a maximum of 32 characters
SNMP:RW Community:String(32)	(Required if you enter a value in the SNMP:Version:Enumeration (2c 3) field). Enter a string for Read Write Community with a maximum of 32 characters.
SNMP:Username:String(32)	Enter a string with a maximum of 32 characters.
	(Required if you enter SNMP version 3 in the SNMP:Version:Enumeration (2c 3) field) Enter Auth , No Auth , or Priv .
SNMP:Authentication Protocol:Enumeration(MD5 SHA)	(Required if you have entered Auth or Priv for the SNMP security level.) Enter MD5 or SHA .
SNMP:Authentication Password:String(32)	(Required if you have entered Auth in the SNMP:Security Level:Enumeration(Auth No Auth Priv) field.) Enter a string with a maximum of 32 characters.
SNMP:Privacy Protocol:Enumeration(DES AES128 AES192 AES256 3DES)	(Required if you have entered Priv in the SNMP:Security Level:Enumeration(Auth No Auth Priv) field.) Enter DES , AES128 , AES192 , AES256 , or 3DES .
SNMP:Privacy Password:String(32)	(Required if you have entered Priv in the SNMP:Security Level:Enumeration(Auth No Auth Priv) field.) Enter a string with a maximum of 32 characters.

Field	Usage Guidelines
SNMP:Polling Interval:Integer:600-86400 seconds	Enter the SNMP polling interval, in seconds. A valid value is an integer from 600 to 86400.
SNMP:Is Link Trap Query:Boolean(true false)	Enable or disable the SNMP link trap by entering true or false .
SNMP:Is MAC Trap Query:Boolean(true false)	Enable or disable the SNMP MAC trap by entering true or false .
SNMP:Originating Policy Services Node:String(32)	Indicate which Cisco ISE server must be used to poll for SNMP data. It is automatic by default, but you can overwrite the setting by assigning different values in this field.
Trustsec:Device Id:String(32)	Enter a Cisco Trustsec device ID, which is a string with a maximum of 32 characters.
Trustsec:Device Password:String(256)	(Required if you have entered a Cisco TrustSec device ID.) Enter a Cisco TrustSec device password, which is a string with a maximum of 256 characters.
Trustsec:Environment Data Download Interval:Integer:1-2147040000 seconds	Enter the Cisco TrustSec environment data download interval. A valid value is an integer from 1 to 2147040000.
Trustsec:Peer Authorization Policy Download Interval:Integer:1-2147040000 seconds	Enter the Cisco TrustSec peer authorization policy download interval. A valid value is an integer from 1 to 2147040000.
Trustsec:Reauthentication Interval:Integer:1-2147040000 seconds	Enter the Cisco TrustSec reauthentication interval. A valid value is an integer from 1 to 2147040000.
Trustsec:SGACL List Download Interval:Integer:1-2147040000 seconds	Enter the Cisco TrustSec security group ACL list download interval. A valid value is an integer from 1 to 2147040000.
Trustsec:Is Other Trustsec Devices Trusted:Boolean(true false)	Indicate whether a Cisco TrustSec device is trusted by entering true or false .
Trustsec:Notify this device about Trustsec configuration changes:String(ENABLE_ALL DISABLE_ALL)	Notify Cisco TrustSec configuration changes to the Cisco TrustSec device by entering ENABLE_ALL or DISABLE_ALL .
Trustsec:Include this device when deploying Security Group Tag Mapping Updates:Boolean(true false)	Indicate if the Cisco TrustSec device is included in security group tag by entering true or false .
Deployment:Execution Mode Username:String(32)	Enter the user name that has privileges to edit the network device configuration. It is a string with a maximum of 32 characters.

Field	Usage Guidelines
Deployment:Execution Mode Password:String(32)	Enter the device password, which is a string with a maximum of 32 characters.
Deployment:Enable Mode Password:String(32)	Enter the password of the device that allows you to edit its configuration. It is a string with a maximum of 32 characters.
Trustsec:PAC issue date:Date	Enter the issuing date of the last Cisco TrustSec PAC that was generated by Cisco ISE for the Cisco TrustSec device.
Trustsec:PAC expiration date:Date	Enter the expiration date of the last Cisco TrustSec PAC that was generated by Cisco ISE for the Cisco TrustSec device.
Trustsec:PAC issued by:String	Enter the name of the issuer (a Cisco TrustSec administrator) of the last Cisco TrustSec PAC that was generated by Cisco ISE for the Cisco TrustSec device. It must be a string value.

Network Device Groups Import Template Format

The following table lists the fields in the template header and provides a description of the fields in the Network Device Group CSV file.

Table 13: CSV Template Fields and Description for Network Device Groups

Field	Description
Name:String(100):	(Required) This field is the network device group name. It is a string with a maximum of 100 characters in length. The full name of an NDG can have a maximum of 100 characters in length. For example, if you are creating a subgroup India under the parent groups Global > Asia, then the full name of the NDG that you are creating would be Global#Asia#India and this full name cannot exceed 100 characters in length. If the full name of the NDG exceeds 100 characters in length, the NDG creation fails.
Description:String(1024)	This is an optional network device group description. It is a string, with a maximum of 1024 characters in length.
Type:String(64):	(Required) This field is the network device group type. It is a string, with a maximum of 64 characters in length.

Field	Description
Is Root:Boolean(true false):	(Required) This is a field that determines if the specific network device group is a root group. Valid value is true or false.

IPsec Security to Secure Communication Between Cisco ISE and NAD

IPsec is a set of protocols that provides security to IP. The AAA, RADIUS, and TACACS+ protocols use the MD5 hashing algorithm. For greater security, Cisco ISE offers the IPsec feature. IPsec provides secure communication by authenticating the sender, discovering any changes in data during transmission, and encrypting the data that is sent.

Cisco ISE supports IPsec in tunnel and transport modes. When you enable IPsec on a Cisco ISE interface and configure the peers, an IPsec tunnel is created between Cisco ISE and the NAD to secure the communication.

You can define a pre-shared key or use X.509 certificates for IPsec authentication. IPsec can be enabled on Gigabit Ethernet 1 through Gigabit Ethernet 5 interfaces. You can configure IPsec on only one Cisco ISE interface per PSN.

IPsec cannot be enabled on Gigabit Ethernet 2 as the smart license is enabled (e0/2—> eth2) by default. However, if you are required to enable IP Security, you have to choose a different interface for smart licensing.



Note Gigabit Ethernet 0 and Bond 0 (when Gigabit Ethernet 0 and Gigabit Ethernet 1 interfaces are bonded) are management interfaces in the Cisco ISE CLI. IPsec is not supported on Gigabit Ethernet 0 and Bond 0.

Required components include:

- Cisco ISE Release 2.2 and later.
- Cisco IOS Software, C5921 ESR Software (C5921_I86-UNIVERSALK9-M): The ESR 5921 configuration, by default, supports IPsec in tunnel and transport modes. Diffie-Hellman Group 14 and Group 16 are supported.



Note The C5921 ESR software is bundled with Cisco ISE, Releases 2.2 and later. You need an ESR license to enable it. See [Cisco 5921 Embedded Services Router Integration Guide](#) for ESR licensing information.

Configure RADIUS IPsec on Cisco ISE

To configure RADIUS IPsec on Cisco ISE, you must:

Step 1 Configure IP address on the interface from the Cisco ISE CLI.

Gigabit Ethernet 1 through Gigabit Ethernet 5 interfaces (Bond 1 and Bond 2) support IPsec. However, IPsec can be configured only on one interface in a Cisco ISE node.

Step 2 Add a directly connected network device to the IPsec network device group.

Note RADIUS IPsec requires the static route gateway to be directly connected through an interface of the device.

- a) Choose **Administration > Network Resources > Network Devices**.
- b) In the **Network Devices** window, click **Add**.
- c) Enter the name and IP address and subnet of the network device that you want to add in the corresponding fields.
- d) From the IPSEC drop-down list, choose **Yes**.
- e) Check the **RADIUS Authentication Settings** check box.
- f) In the **Shared Secret** field, enter the shared secret key that you have configured on the network device.
- g) Click **Submit**.

Step 3 (Optional; required only for Smart Licensing) Add a separate management interface to interact with the Cisco Smart Software Manager (CSSM). See [Smart Software Manager satellite](#) for information on Embedded Services Router (ESR). To do this, from the Cisco ISE CLI, run the following command to select the corresponding management interface (Gigabit Ethernet 1 to 5 (or Bond 1 or 2)):

```
ise/admin# license esr smart {interface}
```

This interface must be able to reach Cisco.com to access the Cisco online licensing server.

Step 4 Add a network device to a directly connected gateway from the Cisco ISE CLI.

```
ip route [destination network] [network mask] gateway [next-hop address]
```

Step 5 Activate IPsec on Cisco ISE nodes.

- a) Choose **Administration > System > Settings > Protocols > IPsec**.

All the Cisco ISE nodes in the deployment are listed in this window.

- b) Check the check box next to the Cisco ISE node on which you want to activate IPsec, and then click the **Enable** radio button.
- c) Choose the interface that you want to use for IPsec communication from the **IPsec Interface for selected nodes** drop-down list.
- d) Click the radio button for one the following authentication type for the selected Cisco ISE node:
 - **Pre-shared Key:** If you choose this option, you must enter the pre-shared key and configure the same key on the network device. Use alphanumeric characters for the pre-shared key. Special characters are not supported. For instructions on how to configure the pre-shared key on the network device, see the network device documentation. For an example of the pre-shared key configuration output, see [Example: Output of Pre-shared Key Configuration on Cisco Catalyst 3850 Series Switches, on page 240](#).
 - **X.509 Certificates:** If you choose this option, from the Cisco ISE CLI, go to the ESR shell and configure and install X.509 Certificates for ESR 5921. Then, configure the network device for IPsec. For instructions, see [Configure and Install X.509 Certificates on ESR-5921, on page 235](#).

- e) Click **Save**.

Note You cannot modify IPsec configurations directly. To modify the IPsec tunnel or authentication when IPsec is enabled, disable the current IPsec tunnel, modify the IPsec configuration, and then re-enable the IPsec tunnel with a different configuration.

Note When enabled, IPsec removes the IP address from the Cisco ISE interface and shuts down the interface. When the user logs in from Cisco ISE CLI, the interface is displayed with no IP address and in shutdown state. This IP address will be configured on the ESR-5921 interface.

Step 6 Type `esr` to enter into the ESR shell.

```
ise/admin# esr
% Entering ESR 5921 shell
% Cisco IOS Software, C5921 Software (C5921_I86-UNIVERSALK9-M), Version 15.5(2)T2, RELEASE SOFTWARE (fc3)
% Technical Support: http://www.cisco.com/techsupport
% Copyright (c) 1986-2015 Cisco Systems, Inc.
```

Press RETURN to get started, CTRL-C to exit

```
ise-esr5921>
ise-esr5921>
```

Note For FIPS compliance, you must configure a secret password that is at least eight characters in length. Enter the **Enable secret level 1** command to specify the password:

```
ise-esr5921(config)#enable secret level 1 ?
0 Specifies an UNENCRYPTED password will follow
5 Specifies a MD5 HASHED secret will follow
8 Specifies a PBKDF2 HASHED secret will follow
9 Specifies a SCRYPT HASHED secret will follow
LINE The UNENCRYPTED (cleartext) 'enable' secret
```

Note If you configure customized RADIUS ports from the GUI (other than 1645, 1646, 1812, and 1813), you must enter the following CLI command in the ESR shell to accept the configured RADIUS ports:

```
ip nat inside source static udp 10.1.1.2 [port_number] interface Ethernet0/0 [port_number]
```

Step 7 (Optional; required only if you have not enabled Smart Licensing in Step 3) Add a Cisco ISE Classic license or an Evaluation license (that is valid for 90 days) to the Cisco ISE appliances.

- Run the following command from the Cisco ISE CLI to download the license file:

```
ise/admin# license esr classic import esr.lic repository esrepo
```

For more information on Cisco ISE Classic licensing, see the section: Licensing the Software with Classic Licensing in [Cisco 5921 Embedded Services Router Integration Guide](#).

Step 8 Verify IPsec tunnel and RADIUS authentication over IPsec tunnel.

- Add a user in Cisco ISE and assign the user to a user group (**Administration > Identity Management > Identities > Users**).
- Carry out the following steps to verify if the IPsec tunnel is established between Cisco ISE and the NAD:

- Use the **ping** command to test if the connection between Cisco ISE and the NAD is established.
- Run the following command from the ESR shell or the NAD CLI to verify if the connection is in the active state:

show crypto isakmp sa

```
ise-esr5921#show crypto isakmp sa
IPv4 Crypto ISAKMP SA
dst          src          state          conn-id status
192.168.30.1 192.168.30.3 QM_IDLE       1001 ACTIVE
```

- Run the following command from the ESR shell or the NAD CLI to verify if the tunnel is established:

show crypto ipsec sa

```

ise-esr5921#show crypto ipsec sa

interface: Ethernet0/0
  Crypto map tag: radius, local addr 192.168.30.1

protected vrf: (none)
local ident (addr/mask/prot/port): (192.168.30.1/255.255.255.255/0/0)
remote ident (addr/mask/prot/port): (192.168.30.2/255.255.255.255/0/0)
current_peer 192.168.30.2 port 500
  PERMIT, flags={}
  #pkts encaps: 52, #pkts encrypt: 52, #pkts digest: 52
  #pkts decaps: 57, #pkts decrypt: 57, #pkts verify: 57
  #pkts compressed: 0, #pkts decompressed: 0
  #pkts not compressed: 0, #pkts compr. failed: 0
  #pkts not decompressed: 0, #pkts decompress failed: 0
  #send errors 0, #recv errors 0

local crypto endpt.: 192.168.30.1, remote crypto endpt.: 192.168.30.2
plaintext mtu 1438, path mtu 1500, ip mtu 1500, ip mtu idb Ethernet0/0
current outbound spi: 0x393783B6(959939510)
PFS (Y/N): N, DH group: none

inbound esp sas:
  spi: 0x8EA0F6EE(2392913646)
    transform: esp-aes esp-sha256-hmac ,
    in use settings ={Tunnel, }
    conn id: 99, flow_id: SW:99, sibling_flags 80000040, crypto map: radius
    sa timing: remaining key lifetime (k/sec): (4237963/2229)
    IV size: 16 bytes
    replay detection support: Y
    Status: ACTIVE(ACTIVE)

inbound ah sas:

inbound pcp sas:

outbound esp sas:
  spi: 0x393783B6(959939510)
    transform: esp-aes esp-sha256-hmac ,
    in use settings ={Tunnel, }
    conn id: 100, flow_id: SW:100, sibling_flags 80000040, crypto map: radius
    sa timing: remaining key lifetime (k/sec): (4237970/2229)
    IV size: 16 bytes
    replay detection support: Y
    Status: ACTIVE(ACTIVE)

outbound ah sas:

outbound pcp sas:

```

c) Verify the RADIUS authentication using one of the following methods:

- Log in to the network device using the credentials of the user that you created in Step 8 (a). The RADIUS authentication request is sent to the Cisco ISE node. View the details in the **Live Authentications** window.
- Connect the end host with the network device and configure 802.1X authentication. Log in to the end host using the credentials of the user that you created in Step 8 (a). The RADIUS authentication request is sent to the Cisco ISE node. View the details in the **Live Authentications** window.

Configure and Install X.509 Certificates on ESR-5921

Step 1 Type `esr` to enter into the ESR shell.

```
ise/admin# esr
% Entering ESR 5921 shell
% Cisco IOS Software, C5921 Software (C5921_I86-UNIVERSALK9-M), Version 15.5(2)T2, RELEASE SOFTWARE (fc3)
% Technical Support: http://www.cisco.com/techsupport
% Copyright (c) 1986-2015 Cisco Systems, Inc.
```

Press RETURN to get started, CTRL-C to exit

```
ise-esr5921>
ise-esr5921>
```

Note For FIPS compliance, you must configure a secret password that is at least eight characters in length. Enter the **Enable secret level 1** command to specify the password:

```
ise-esr5921(config)#enable secret level 1 ?
0 Specifies an UNENCRYPTED password will follow
5 Specifies a MD5 HASHED secret will follow
8 Specifies a PBKDF2 HASHED secret will follow
9 Specifies a SCRYPT HASHED secret will follow
LINE The UNENCRYPTED (cleartext) 'enable' secret
```

Note If you configure customized RADIUS ports from the GUI (other than 1645, 1646, 1812, and 1813), you must enter the following CLI command in the ESR shell to accept the RADIUS ports that are configured:

```
ip nat inside source static udp 10.1.1.2 [port_number] interface Ethernet0/0 [port_number]
```

Step 2 Generate an RSA key pair using the following command:

Example:

```
crypto key generate rsa label rsa2048 exportable modulus 2048
```

Step 3 Create a trustpoint using the following command:

Example:

```
crypto pki trustpoint trustpoint-name

enrollment terminal
serial-number none
fqdn none
ip-address none
subject-name cn=networkdevicename.cisco.com
revocation-check none
rsa keypair rsa2048
```

Step 4 Generate a certificate signing request using the following command:

Example:

```
crypto pki enroll rsaca-mytrustpoint

Display Certificate Request to terminal? [yes/no]: yes
```

Step 5 Copy the output of the certificate signing request to a text file, submit it to an external CA for signing, and obtain the signed certificate and the CA certificate.

Step 6 Import the Certificate Authority (CA) certificate using the following command:

Example:

```
crypto pki authenticate rsaca-mytrustpoint
```

Copy and paste the contents of the CA certificate, including the "**—BEGIN—**" and "**—End—**" lines.

Step 7 Import the signed certificate using the following command:

Example:

```
crypto pki import rsaca-mytrustpoint
```

Copy and paste the contents of the signed certificate, including the "**—BEGIN—**" and "**—End—**" lines.

The following is an example of the output that is displayed when you configure and install X.509 Certificates on Cisco 5921 ESR:

```
ise-esr5921#show running-config
!
hostname ise-esr5921
!
boot-start-marker
boot host unix:default-config
boot-end-marker
!
no aaa new-model
bsd-client server url https://cloudsso.cisco.com/as/token.oauth2
mmi polling-interval 60
no mmi auto-configure
no mmi pvc
mmi snmp-timeout 180
call-home
! If contact email address in call-home is configured as sch-smart-licensing@cisco.com
! the email address configured in Cisco Smart License Portal will be used as contact email address
to send SCH notifications.
contact-email-addr sch-smart-licensing@cisco.com
profile "CiscoTAC-1"
  active
  destination transport-method http
  no destination transport-method email
!
ip cef
no ipv6 cef
!
multilink bundle-name authenticated
!
crypto pki trustpoint SLA-TrustPoint
enrollment pkcs12
revocation-check crl
!
crypto pki trustpoint rsaca-mytrustpoint
enrollment terminal
serial-number none
fqdn none
ip-address none
subject-name cn=ise-5921.cisco.com
revocation-check none
rsa-keypair rsa2048
!
crypto pki certificate chain SLA-TrustPoint
certificate ca 01
  30820321 30820209 A0030201 02020101 300D0609 2A864886 F70D0101 0B050030
  32310E30 0C060355 040A1305 43697363 6F312030 1E060355 04031317 43697363
  6F204C69 63656E73 696E6720 526F6F74 20434130 1E170D31 33303533 30313934
```



```

3834375A 170D3338 30353330 31393438 34375A30 32310E30 0C060355 040A1305
43697363 6F312030 1E060355 04031317 43697363 6F204C69 63656E73 696E6720
526F6F74 20434130 82012230 0D06092A 864886F7 0D010101 05000382 010F0030
82010A02 82010100 A6BCBD96 131E05F7 145EA72C 2CD686E6 17222EA1 F1EFF64D
CBB4C798 212AA147 C655D8D7 9471380D 8711441E 1AAF071A 9CAE6388 8A38E520
1C394D78 462EF239 C659F715 B98C0A59 5BBB5CBD 0CFEBEA3 700A8BF7 D8F256EE
4AA4E80D DB6FD1C9 60B1FD18 FFC69C96 6FA68957 A2617DE7 104FDC5F EA2956AC
7390A3EB 2B5436AD C847A2C5 DAB553EB 69A9A535 58E9F3E3 C0BD23CF 58BD7188
68E69491 20F320E7 948E71D7 AE3BCC84 F10684C7 4BC8E00F 539BA42B 42C68BB7
C7479096 B4CB2D62 EA2F505D C7B062A4 6811D95B E8250FC4 5D5D5FB8 8F27D191
C55F0D76 61F9A4CD 3D992327 A8BB03BD 4E6D7069 7CBADF8B DF5F4368 95135E44
DFC7C6CF 04DD7FD1 02030100 01A34230 40300E06 03551D0F 0101FF04 04030201
06300F06 03551D13 0101FF04 05300301 01FF301D 0603551D 0E041604 1449DC85
4B3D31E5 1B3E6A17 606AF333 3D3B4C73 E8300D06 092A8648 86F70D01 010B0500
03820101 00507F24 D3932A66 86025D9F E838AE5C 6D4DF6B0 49631C78 240DA905
604EDCDE FF4FED2B 77FC460E CD636FDB DD44681E 3A5673AB 9093D3B1 6C9E3D8B
D98987BF E40CBD9E 1AECA0C2 2189BB5C 8FA85686 CD98B646 5575B146 8DFC66A8
467A3DF4 4D565700 6ADF0F0D CF835015 3C04FF7C 21E878AC 11BA9CD2 55A9232C
7CA7B7E6 C1AF74F6 152E99B7 B1FCF9BB E973DE7F 5BDDEB86 C71E3B49 1765308B
5FB0DA06 B92AFE7F 494E8A9E 07B85737 F3A58BE1 1A48A229 C37C1E69 39F08678
80DDCD16 D6BACECA EEB7CF9 8428787B 35202CDC 60E4616A B623CDBD 230E3AFB
418616A9 4093E049 4D10AB75 27E86F73 932E35B5 8862FDAE 0275156F 719BB2F0
D697DF7F 28
quit
crypto pki certificate chain rsaca-mytrustpoint
certificate 39
30820386 3082026E A0030201 02020139 300D0609 2A864886 F70D0101 0B050030
61310B30 09060355 04061302 5553310B 30090603 5504080C 024E4331 0C300A06
03550407 0C035254 50310E30 0C060355 040A0C05 43495343 4F310C30 0A060355
040B0C03 53544F31 19301706 03550403 0C107273 6163612E 65726368 616F2E63
6F6D301E 170D3136 30393031 32313037 34335A17 0D313730 39303132 31303734
335A301D 311B3019 06035504 03131269 73652D35 3932312E 63697363 6F2E636F
6D308201 22300D06 092A8648 86F70D01 01010500 0382010F 00308201 0A028201
0100EE87 CABFBA18 7E0405A8 ACAAAB23 E7CB6109 2CF98BAE 8EE93536 BF1EBBD3
73E60BE7 F430B5AF EBF8B0C5 969B2828 A6783BB4 64E333E4 29C8744E 6E783617
194AF1B0 7F04B4EA B89FD6EB F9C4F2DD 196DC6E0 CAA49B8B 665B6E0D 2FBC1D2F
8E8181B9 60FAE126 D1B2E4E4 1F321A97 10C1B76A C2BB3174 361B13FA 2CB7BDFE
22C0C33F 2792D714 C41E2237 00B1AE49 6593DCC3 A799D526 D81F9706 A71DA14E
5ED76038 7A2C84B4 C668E35C 337BA1DC 9CA56AC2 C8E0059F 660CE39C 925310A0
F9A21FFB 3C3C507A 20B924F7 E0125D60 6552321C 35736079 42449401 15E68DA6
B4776DAA FB5AFDF8 59E31373 263175E3 1F14416A 24C21D69 A46173B6 96CC84FB
5B9D0203 010001A3 818C3081 89300906 03551D13 04023000 302C0609 60864801
86F84201 0D041F16 1D4F7065 6E53534C 2047656E 65726174 65642043 65727469
66696361 7465301D 0603551D 0E041604 146DD31C 03690B98 330B67FA 6EDC7B20
F99FB924 60301F06 03551D23 04183016 8014966A 0C21AF96 3E827690 423599CC
EE8087A1 2909300E 0603551D 0F0101FF 04040302 05A0300D 06092A86 4886F70D
01010B05 00038201 0100C0B9 D2845D97 6FFC16DB 01559659 BC1DECA6 E1A01965
1F6CD459 E03D7ABE 91179FEB 08BF5B9B 84B62C36 236F528E E30C921C 81DA29E1
EA3DFDC1 B0B0EEBA 14EADAEC 078576E4 D643A0EF 7D8E0880 C5FC3965 811B08C0
5696DBF5 FADA4092 ACF549B8 2257F508 636D52AA 6CDC9596 AB43313F 6C33C9C1
2CFDDBE3 EA9D407C 8D1B0F49 BBACD0CD 2832AC12 CD3FEFC8 501E1639 A4EFDC27
69CA0147 971A1B2D DB2758E6 A84AFC86 4F9A4942 3D7EDBCC 7BDC1BB 61F69B31
BF13E39B 10AAC31C 55E73C8B C30BE516 7C506FF4 AC367D94 814A6880 EF201A6D
CD2E1A95 7BBEC982 01CE867D 931F56E1 1EF1C457 9DC9A0BE 9DB2DC9B 19873585
89AE82F6 A37E51D6 EEC
quit
certificate ca 008DD3A81106B14664
308203A2 3082028A A0030201 02020900 8DD3A811 06B14664 300D0609 2A864886
F70D0101 05050030 61310B30 09060355 04061302 5553310B 30090603 5504080C
024E4331 0C300A06 03550407 0C035254 50310E30 0C060355 040A0C05 43495343
4F310C30 0A060355 040B0C03 53544F31 19301706 03550403 0C107273 6163612E
65726368 616F2E63 6F6D301E 170D3135 31303231 32313135 34335A17 0D323531
30313832 31313534 335A3061 310B3009 06035504 06130255 53310B30 09060355
04080C02 4E43310C 300A0603 5504070C 03525450 310E300C 06035504 0A0C0543

```

```

4953434F 310C300A 06035504 0B0C0353 544F3119 30170603 5504030C 10727361
63612E65 72636861 6F2E636F 6D308201 22300D06 092A8648 86F70D01 01010500
0382010F 00308201 0A028201 0100CB82 2AECCE38 1BCB27B9 FA5F2FBD 8609B190
16A6F741 5BEC18B8 8B260CAF 190EA1CE 063BC558 556DC085 6FAC5425 14AFE225
0E9E3A12 05F3DA7E D17E03F2 7FFE92FB 38D67027 DBC5C175 EB53E96B 66C20D11
B4C32D38 AE04385C 8FD4CB74 31A97824 CA1CAFD5 091806C3 6F9CBF8D DC42DD5B
D985703D F3BB9ED1 7DE99614 422D765C 86AB25CD E80008C5 22049BE8 66D1CA27
E1EB6D4F 4FD3CC18 E091BBF0 6FE0EB52 B33F231A 6D6B7190 4196C929 D22E2C42
B9CD2BBD 24550E82 8CD8838F C41B4DAD 2FA1636A 5787BBB2 F21E4718 335B005B
DFBE6EA7 56EBE30B D52DE85F FFAF0189 E372CBFC 44BFF235 4DA7C9EF DAAC6D0A
A196DA5A 1B525175 C26B3581 EA4B0203 010001A3 5D305B30 1D060355 1D0E0416
0414966A 0C21AF96 3E827690 423599CC EE8087A1 2909301F 0603551D 23041830
16801496 6A0C21AF 963E8276 90423599 CCEE8087 A1290930 0C060355 1D130405
30030101 FF300B06 03551D0F 04040302 02A4300D 06092A86 4886F70D 01010505
00038201 01002334 A3F0E5D3 4D229985 67A07754 73EC52E3 05E7D05F 926CC863
220F849B 861C36B2 EF7C3485 474D4EF0 73895879 CAE08BBB 183B7CFA A20C4354
86C6D9DF D445DACE C252C608 236F6673 F3F3C329 474B22E8 660BF91E 41054B8D
43B80E44 AE69C164 2C9F41A2 8284F577 21FFAB8E A6771A5E DD34EBE4 A0DC2EAD
95702010 02964566 478DA90F 5E134643 81A5F5EA 362D0394 1F9F23D1 DEE50B07
12938299 1AF11A36 82DAFC6A 164B2F66 8B0AB7CC 9A723EBC B50E740B 0A9270E3
60E2ED42 7F10D1A6 F6735144 AE93BF86 3D5A0502 6811D2BD 6E694693 28DE84C5
3747CF0A D2B8D6C9 6CBEBA0A D1137CF8 E31CBF6B 437D82DD D74A4A9F 3557B3D9
D0BD055F 65A8
quit
license udi pid CISCO5921-K9 sn 9XG4481W768
username lab password 0 lab
!
redundancy
!
crypto keyring MVPN-spokes
rsa-publickey address 0.0.0.0
address 0.0.0.0
key-string
quit
!
crypto isakmp policy 10
encr aes
hash sha256
group 16
!
crypto isakmp policy 20
encr aes
hash sha256
group 14
crypto isakmp profile MVPN-profile
description LAN-to-LAN for spoke router(s) connection
keyring MVPN-spokes
match identity address 0.0.0.0
!
crypto ipsec transform-set radius esp-aes esp-sha256-hmac
mode tunnel
crypto ipsec transform-set radius-2 esp-aes esp-sha256-hmac
mode transport
!
crypto dynamic-map MVPN-dynmap 10
set transform-set radius radius-2
!
crypto map radius 10 ipsec-isakmp dynamic MVPN-dynmap
!
interface Ethernet0/0
description e0/0->connection to external NAD
ip address 192.168.20.1 255.255.255.0
ip nat outside
ip virtual-reassembly in

```

```
no ip route-cache
crypto map radius
!
interface Ethernet0/1
description e0/1->tap0 internal connection to ISE
ip address 10.1.1.1 255.255.255.252
ip nat inside
ip virtual-reassembly in
no ip route-cache
!
interface Ethernet0/2
no ip address
shutdown
!
interface Ethernet0/3
no ip address
shutdown
!
ip forward-protocol nd
!
no ip http server
no ip http secure-server
ip nat inside source list 1 interface Ethernet0/0 overload
ip nat inside source static udp 10.1.1.2 1645 interface Ethernet0/0 1645
ip nat inside source static udp 10.1.1.2 1646 interface Ethernet0/0 1646
ip nat inside source static udp 10.1.1.2 1812 interface Ethernet0/0 1812
ip nat inside source static udp 10.1.1.2 1813 interface Ethernet0/0 1813
!
access-list 1 permit 10.1.1.0 0.0.0.3
!
control-plane
!
line con 0
logging synchronous
line aux 0
line vty 0 4
login
transport input none
!
end
```

The following is an example of the output that is displayed when you configure and install X.509 certificates on Cisco Catalyst 3850 Series Switches:

```
cat3850#show running-config

enable password lab
!
username lab password 0 lab
aaa new-model

!

aaa group server radius ise
server name ise-vm
deadtime 60
!
aaa authentication login default group radius local

aaa authentication enable default group radius enable

!

crypto isakmp policy 10
```

Example: Output of Pre-shared Key Configuration on Cisco Catalyst 3850 Series Switches

```

encr aes

hash sha256
authentication rsa-sig
group 16
!
crypto ipsec security-association lifetime seconds 86400
!
crypto ipsec transform-set radius esp-aes esp-sha256-hmac
mode tunnel

!

crypto ipsec profile radius-profile

!

crypto map radius 10 ipsec-isakmp
set peer 192.168.20.1
set transform-set radius

match address 100

!

interface GigabitEthernet1/0/1
no switchport
ip address 192.168.20.2 255.255.255.0

crypto map radius

!
access-list 100 permit ip host 192.168.20.2 host 192.168.20.1
!
snmp-server community public RO
snmp-server community private RW
!
radius server rad-ise
address ipv4 192.168.20.1 auth-port 1645 acct-port 1646

key secret

```

Example: Output of Pre-shared Key Configuration on Cisco Catalyst 3850 Series Switches

The following is an example of the output that is displayed when you configure the pre-shared key on Cisco Catalyst 3850 Series Switches:

```

cat3850#show running-config

enable password lab
!
username lab password 0 lab
aaa new-model
!
aaa group server radius ise
server name ise-vm
deadtime 60
!

```

```
aaa authentication login default group radius local

aaa authentication enable default group radius enable

!

crypto isakmp policy 10

  encr aes

  hash sha256
  authentication pre-share
  group 16
  crypto isakmp key 123456789 address 0.0.0.0
  !
  crypto ipsec security-association lifetime seconds 86400
  !
  crypto ipsec transform-set radius esp-aes esp-sha256-hmac
  mode tunnel
  !
  crypto ipsec profile radius-profile
  !
  crypto map radius 10 ipsec-isakmp
  set peer 192.168.20.1
  set transform-set radius
  match address 100
  !
interface GigabitEthernet1/0/1
  no switchport
  ip address 192.168.20.2 255.255.255.0

  crypto map radius
  !
  access-list 100 permit ip host 192.168.20.2 host 192.168.20.1
  !
  snmp-server community public RO
  snmp-server community private RW
  !
  radius server rad-ise
  address ipv4 192.168.20.1 auth-port 1645 acct-port 1646

key secret
```

Mobile Device Manager Interoperability with Cisco ISE

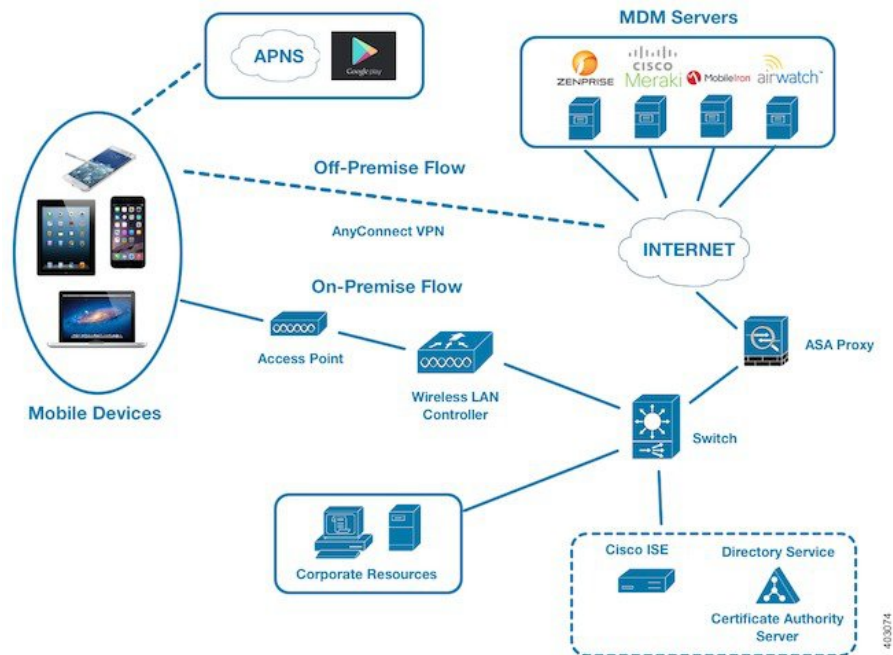
Mobile Device Management (MDM) servers secure, monitor, manage, and support mobile devices that are deployed across mobile operators, service providers, and enterprises. Traditionally, MDM servers have only supported mobile devices. Some MDM servers now manage all types of devices in a network (mobile phones, tablets, laptops, and desktops) and are called Unified Endpoint Management (UEM) servers. MDM servers act as a policy server that controls the use of some applications on a mobile device (for example, an email application) in the deployed environment. Cisco ISE queries a connected MDM server for information about various attributes that you can use to create network authorization policies.

You can run multiple active MDM servers on your network, from different vendors. This allows you to route different endpoints to different MDM servers based on device factors such as location or device type.

Cisco ISE also integrates with MDM servers using the Cisco MDM Server Info APIs, Version 2 and later versions, to allow devices to access the network over VPN via Cisco AnyConnect 4.1 and Cisco Adaptive Security Appliances 9.3.2 or later.

In the following illustration, Cisco ISE is the enforcement point and the MDM policy server is the policy information point. Cisco ISE obtains data from the MDM server to provide a complete solution.

Figure 19: MDM Interoperability with Cisco ISE



Configure Cisco ISE to interoperate with one or more external MDM servers. By setting up this type of third-party connection, you can use the detailed information available in the MDM database. Cisco ISE uses REST API calls to retrieve information from the external MDM server. Cisco ISE applies the appropriate access control policies to switches, access routers, wireless access points, and other network access points. The policies give you greater control of the remote devices that are accessing the Cisco ISE-enabled network.

For a list of the MDM vendors supported by Cisco ISE, see [Supported Unified Endpoint Management and Mobile Device Management Servers](#), on page 245.

Supported Mobile Device Management Use Cases

Cisco ISE performs the following functions with external MDM servers:

- **Manages device registration:** Unregistered endpoints that access the network are redirected to a registration page that is hosted on the MDM server. Device registration includes the user role, device type, and so on.
- **Handles device remediation:** Endpoints are granted restricted access during remediation.
- **Augments endpoint data:** The endpoint database is updated with information from the MDM server that you cannot gather using the Cisco ISE profiling services. Cisco ISE uses multiple device attributes that you can view in the **Endpoints** window. Choose **Work Centers > Network Access > Identities > Endpoints**.

The following are examples of the device attributes available.

- MDMMei: xx xxxxxx xxxxxx x
 - MDMManufacturer: Apple
 - MDModel: iPhone
 - MDAMOSVersion: iOS 6.0.0
 - MDMPhoneNumber: 5550100
 - MDMSerialNumber: DNPGQZGUDTFx
- Polls the MDM server every four hours for device compliance data. Configure the polling interval in the **External MDM Servers** window. (To view this window, choose **Work Centers > Network Access > Network Resources > External MDM Servers**.)
 - Issues device instructions through the MDM server: Cisco ISE issues remote actions for user devices through the MDM server. Initiate remote actions from the Cisco ISE administration portal through the **Endpoints** window. To view this window, choose **Context Visibility > Endpoints**. Check the check box next to the MDM server and click **MDM Actions**. Choose the required action from the drop-down list displayed.

Vendor MDM Attributes

When you configure an MDM server in Cisco ISE, Cisco ISE queries the MDM server for device attribute information and adds the information to the MDM system dictionary. The following attributes are used for registration status, and are commonly supported by MDM vendors.

Cisco ISE uses APIs to query MDM servers for the required device attributes. Cisco ISE Release 3.1 and later releases support MDM APIs Version 3. The Version 3 APIs include APIs that allow Cisco ISE to send queries to MDM servers for device attributes that help Cisco ISE identify endpoints that use MAC address randomization. Cisco ISE queries the MDM server for the following attributes:

- GUID: A unique device identifier that replaces the use of MAC address to identify a device.
- MAC addresses: The list of MAC addresses that a UEM or MDM server has recorded for a particular device. A maximum of five MAC addresses are shared for a device.

If an MDM server does not provide values for the required attributes, Cisco ISE fills the attributes fields with the default values that are mentioned in the following table.

Table 14: MDM Attributes and Values

Attribute Name	Attribute Dictionary	Default Value	Data That is Expected From UEM or MDM Servers	Data That is Expected From Microsoft SCCM Servers
DaysSinceLastCheckin Supported from MDM API Version 3	MDM	None	The number of days since a user has last checked in or synchronized a device with the UEM or MDM server. The valid range is 1–365 days.	The number of days since a user has last checked in or synchronized a device with the SCCM server. The valid range is 1–365 days.

Attribute Name	Attribute Dictionary	Default Value	Data That is Expected From UEM or MDM Servers	Data That is Expected From Microsoft SCCM Servers
DeviceCompliantStatus	MDM	NonCompliant	Compliant or NonCompliant .	Compliant or NonCompliant .
DeviceRegisterStatus	MDM	UnRegistered	Registered or UnRegistered .	Registered or UnRegistered .
DiskEncryptionStatus	MDM	Off	On or Off .	On or Off .
IMEI	MDM	None	The IMEI number of the device.	Not applicable.
JailBrokenStatus	MDM	Unbroken	Reachable or UnReachable .	Reachable or UnReachable .
MDMFailureReason	MDM	None	The device failure reason.	The device failure reason.
MDMServerName	MDM	None	The name of the server.	The name of the server.
MDMServerReachable	MDM	Reachable	Reachable or UnReachable .	Reachable or UnReachable .
MEID	MDM	None	The MEID value of the device.	Not applicable.
Manufacturer	MDM	None	The name of the device manufacturer.	Not applicable.
Model	MDM	None	The name of the device model.	Not applicable.
OsVersion	MDM	None	The operating system version of the device.	Not applicable.
PhoneNumber	MDM	None	The phone number of the device.	Not applicable.
PinLockStatus	MDM	Off	On or Off .	Not applicable.
SerialNumber	MDM	None	The serial number of the device.	Not applicable.
ServerType	MDM	None	MDM for a Mobile Device Manager server. DM for Desktop Device Manager server.	DM for Desktop Device Manager server.
UDID	MDM	None	The UDID number of the device.	Not applicable.

Attribute Name	Attribute Dictionary	Default Value	Data That is Expected From UEM or MDM Servers	Data That is Expected From Microsoft SCCM Servers
UserNotified	MDM	No	Yes or No	Not applicable.

If a vendor's unique attributes are not supported, you may be able to use ERS APIs to exchange vendor-specific attributes. Check the vendor's documentation for information on the ERS APIs that are supported.

The new MDM dictionary attributes are available for use in authorization policies.

Supported Unified Endpoint Management and Mobile Device Management Servers

Supported MDM servers include products from the following vendors:

- Absolute
- Blackberry - BES
- Blackberry - Good Secure EMM
- Cisco Meraki Systems Manager
- Citrix XenMobile 10.x (On-prem)
- Globo
- IBM MaaS360
- Ivanti (previously MobileIron UEM), core and cloud UEM services



Note Some versions of MobileIron do not work with Cisco ISE. MobileIron is aware of this problem, and have a fix. Please contact MobileIron for more information.

- JAMF Casper Suite
- Microsoft Endpoint Configuration Manager
- Microsoft Endpoint Manager Intune
- Mosyle
- SAP Afaria
- Sophos
- SOTI MobiControl
- Symantec
- Tangoe
- VMware Workspace ONE (earlier known as AirWatch)

- 42 Gears

For the configurations that you must perform in your endpoint management servers to integrate the servers with Cisco ISE, see [Integrate UEM and MDM Servers With Cisco ISE](#).

ISE Community Resource

[How To: Meraki EMM / MDM Integration with ISE](#)

Ports Used by the Mobile Device Management Server

The following table lists the ports that must be open between Cisco ISE and an MDM server to enable them to communicate with each other. See the documentation from the MDM vendor for a list of ports that must be open on the MDM agent and server.

Table 15: Ports Used by the MDM Server

MDM Server	Ports
MobileIron	443
Zenprise	443
Good	19005
Airwatch	443
Afaria	443
Fiberlink MaaS	443
Meraki	443
Microsoft Intune	80 and 443
Microsoft SCCM	80 and 443

Mobile Device Management Integration Process Flow

1. The user associates a device with an SSID.
2. Cisco ISE makes an API call to the MDM server.
3. This API call returns a list of devices for the user and the posture statuses for the devices.



Note The input parameter is the MAC address of the endpoint device. For off-premise Apple iOS devices, the input parameter is the UDID.

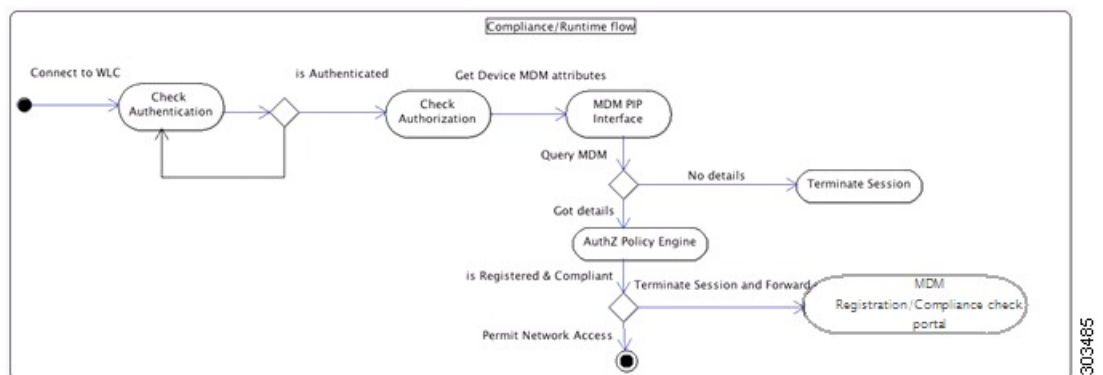
4. If the user's device is not on this list, it means that the device is not registered. Cisco ISE sends an authorization request to the NAD to redirect to Cisco ISE. The user is presented with the MDM server page.



Note You must register a device that is enrolled on the MDM server outside of a Cisco ISE network via the MDM portal. This is applicable for Cisco ISE Release 1.4 and later. Earlier Cisco ISE versions allow devices that are enrolled outside the Cisco ISE-enabled network to be automatically enrolled if they are compliant with the posture policies.

5. Cisco ISE uses MDM to provision the device and presents the appropriate window for the user to register the device.
6. The user registers the device in the MDM server, and the MDM server redirects the request to Cisco ISE through automatic redirection or manual browser refresh.
7. Cisco ISE queries the MDM server again for the posture status.
8. If the user's device is not compliant with the posture (compliance) policies that are configured on the MDM server, the user is notified that the device is out of compliance. The user must take the necessary action to ensure that the device is compliant.
9. When the user's device is compliant, the MDM server updates the device's state in its internal tables.
10. If the user refreshes the browser now, the control is transferred back to Cisco ISE.
11. Cisco ISE polls the MDM server once every four hours to get compliance information and issues the appropriate Change of Authorization (CoA). You can configure the polling interval. Cisco ISE also checks the MDM server every five minutes to make sure that it is available.

The following figure illustrates the MDM process flow.



Note A device can only be enrolled in a single MDM server at a time. If you want to enroll the same device to an MDM service from another vendor, the previous vendor's profiles must be removed from the device. The MDM service usually offers a "corporate wipe", which only deletes the vendor's configuration from the device (not the whole device). The user can also remove the files. For example, on an iOS device, the user can go to the Settings > General > Device management window, and click **Remove Management**. Or the user can go to the MyDevices portal in Cisco ISE and click **Corporate Wipe**.

Set Up Mobile Device Management Servers with Cisco ISE

To set up MDM servers with Cisco ISE, you must perform the following high-level tasks:

-
- Step 1** Import the MDM server certificate into Cisco ISE, except for Intune, where you import the Policy Administration node's (PAN) certificate into Azure.
 - Step 2** Create mobile device manager definitions.
 - Step 3** Configure ACLs on the Wireless LAN Controllers.
 - Step 4** Configure an authorization profile that redirects nonregistered devices to the MDM server.
 - Step 5** If there are multiple MDM servers on the network, configure separate authorization profiles for each vendor.
 - Step 6** Configure authorization policy rules for the MDM use cases.
-

Import Mobile Device Management Server Certificate into Cisco ISE

For Cisco ISE to connect with the MDM server, you must import the MDM server certificate into the Cisco ISE Trusted Certificates store. If your MDM server has a CA-signed certificate, you must import the root certificate into the Cisco ISE Trusted Certificates store.



Note For Microsoft Azure, import the Cisco ISE certificate into Azure. See [Connect Microsoft Intune to Cisco ISE as a Mobile Device Management Server](#).

-
- Step 1** Export the MDM server certificate from your MDM server and save it on your local machine.
 - Step 2** Choose **Administration > System > Certificates > Trusted Certificate > Import**.
 - Step 3** In the **Import a new Certificate into the Certificate Store** window, click **Browse** to select the MDM server certificate that you obtained from the MDM server.
 - Step 4** Add a name for the certificate in the **Friendly Name** field.
 - Step 5** Check the **Trust for authentication within ISE** check box.
 - Step 6** Click **Submit**.
 - Step 7** Verify that the **Trust Certificates** window lists the newly added MDM server certificate.
-

Define Device Management Servers in Cisco ISE

Define mobile and desktop device management servers in Cisco ISE to allow Cisco ISE to communicate with the required servers. You can configure the authentication type used to communicate with the servers, the frequency at which Cisco ISE requests device information from a device management server, and so on.

To define a mobile management server, see [Configure Mobile Device Management Servers in Cisco ISE, on page 249](#).

To define a Microsoft System Center Configuration Manager (SCCM) server, see [Define Microsoft System Center Configuration Manager Servers in Cisco ISE](#), on page 249.

Define Microsoft System Center Configuration Manager Servers in Cisco ISE

- Step 1** Choose **Administration > Network Resources > External MDM > MDM Servers**.
 - Step 2** In the **MDM Servers** window, click **Add**.
 - Step 3** Choose **Desktop Device Manager** from the **Server Type** drop-down list.
 - Step 4** In the **Host Name / IP Address** field, enter the hostname or IP address of the Microsoft SCCM server.
 - Step 5** In the **Instance Name** field, if the Microsoft SCCM server has several instances, enter the instance that you want to connect to.
 - Step 6** In the **Username** field, enter the username that must be used to connect to the Microsoft SCCM server.
 - Step 7** In the **Password** field, enter the password that must be used to connect to the Microsoft SCCM server.
 - Step 8** In the **Time Interval For Compliance Device ReAuth Query** field, enter a value from 1 to 1440 minutes. The default value is one minute. When an endpoint is authenticated or reauthenticated, Cisco ISE uses a cache to get the MDM variables for that endpoint. If the age of the cached value is higher than the value configured in this field, Cisco ISE sends a new device query to the MDM server to get new values. If the compliance status has changed, then Cisco ISE triggers the appropriate CoA.
 - Step 9** Choose **Enabled** from the **Status** drop-down list.
 - Step 10** Click **Test Connection** to check if Cisco ISE can connect to the defined Microsoft SCCM server.
 - Step 11** Click **Save**.
-

Configure Mobile Device Management Servers in Cisco ISE

The following image displays the Cisco ISE GUI fields that you must work with during this task. The numbers in the image correspond to the step numbers in the following task.

Figure 20: Add an MDM Server in Cisco ISE

- Step 1** Choose **Administration > Network Resources > External MDM**.
- Step 2** In the **MDM Servers** window, click **Add**.
- Step 3** Enter the name and description of the MDM server that you want to add in the corresponding fields.
- Step 4** From the **Server Type** drop-down list, choose **Mobile Device Manager**.
- Step 5** From the **Authentication Type** drop-down list, choose either **Basic** or **OAuth - Client Credentials**.

If you choose the **Basic** authentication type, the following fields are displayed:

- **Host Name / IP Address:** Enter the hostname or IP address of the MDM server.
- **Port:** Specify the port to be used when connecting to the MDM server, which is usually 443.
- **Instance Name:** If this MDM server has several instances, enter the instance that you want to connect to.
- **Username:** Enter the username that must be used to connect to the MDM server.
- **Password:** Enter the password that must be used to connect to the MDM server.

If you choose the **OAuth - Client Credentials** authentication type, the following fields are displayed:

- From the **Auto Discovery** drop-down list, choose **Yes** or **No**.
- **Auto Discovery URL:** Enter the value of Microsoft Azure AD Graph API Endpoint from the Microsoft Azure management portal. This URL is the endpoint at which an application can access directory data in your Microsoft Azure AD directory using the Graph API. For more information, see [Integrate MDM and UEM Servers with Cisco ISE](#).
- **Client ID:** The unique identifier for your application. Use this attribute if your application accesses data in another application, such as the Microsoft Azure AD Graph API, Microsoft Intune API, and so on.
- **Token Issuing URL:** Enter the value of the OAuth2.0 Authorization Endpoint. This is the endpoint from which Cisco ISE obtains an access token using OAuth2.0.
- **Token Audience:** The recipient resource that the token is intended for, which is a public, well-known **APP ID URL** to the Microsoft Intune API.

Time Interval For Compliance Device ReAuth Query: When an endpoint is authenticated or reauthenticated, Cisco ISE uses a cache to get the MDM variables for that endpoint. If the age of the cached value is higher than the value configured in this field, Cisco ISE sends a new device query to the MDM server to get new values. If the compliance status has changed, then Cisco ISE triggers the appropriate CoA. The valid range is from 1 to 1440 minutes. The default value is one minute.

Polling Interval: Enter the polling interval, in minutes, for Cisco ISE to poll the MDM server for noncompliant endpoints. Set this value to match the polling interval on your MDM server. The valid range is from 15 to 240 minutes. The default value is 240 minutes. We recommend that you set the polling interval more than 60 minutes in production environments to minimize any performance impact that might occur due to large numbers of noncompliant endpoints.

If you set the polling interval to 0, Cisco ISE disables polling with the MDM server.

Note If the external MDM server receives requests from more than 20000 noncompliant endpoints, the external MDM server polling interval is automatically set to 0. You also receive the following alarm on Cisco ISE:

```
MDM Compliance Polling Disabled: Reason is Periodic Compliance Polling received huge non-compliance device information.
```

- Step 6** From the **Status** drop-down list, choose **Enabled**.
- Step 7** To verify whether the MDM server is connected to Cisco ISE, click **Test Connection**. Note that **Test Connection** is not intended to check permissions for all the use cases (get baselines, get device information, and so on). These are validated when the server is added to Cisco ISE.
- Step 8** Click **Save**.

Cisco ISE Mobile Device Management Support for Microsoft Intune and Microsoft System Center Configuration Manager

- **Microsoft Intune:** Cisco ISE supports Microsoft Intune device management as a partner MDM server to manage mobile devices.

Configure Cisco ISE as an OAuth 2.0 client application on the Microsoft Intune server managing mobile devices. Cisco ISE gets a token from Azure to establish a session with the Cisco ISE Intune application.

For information about how Microsoft Intune communicates with a client application, see

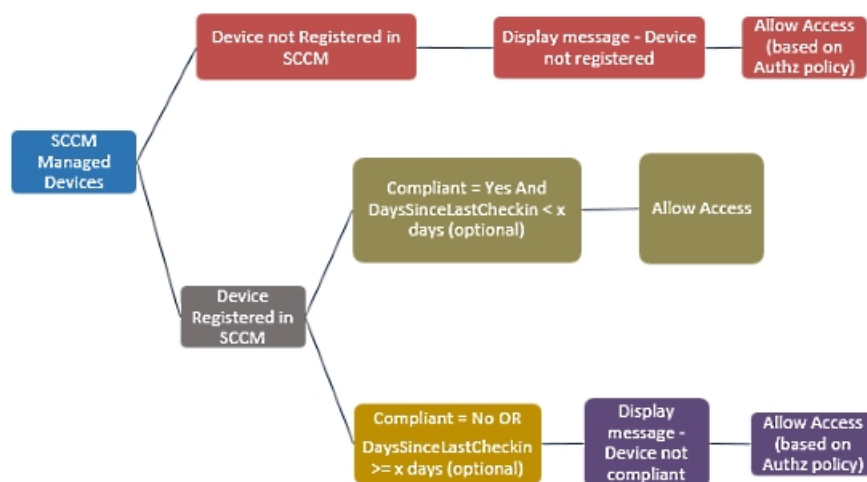
<https://msdn.microsoft.com/en-us/library/azure/dn645543.aspx>.

- **Desktop Device Manager (Microsoft SCCM):** Cisco ISE supports the Microsoft System Center Configuration Manager (SCCM) as a partner MDM server for managing Windows computers. Cisco ISE retrieves compliance information from the Microsoft SCCM server using WMI, and uses that information to grant or deny network access to a user's Windows device.

Microsoft SCCM Workflow

Cisco ISE retrieves information from the Microsoft SCCM server about whether a device is registered, and if it is registered, if it is compliant. The following diagram shows the workflow for devices that are managed by Microsoft SCCM.

Figure 21: SCCM Workflow



When a device connects to the network and a Microsoft SCCM policy is matched, Cisco ISE queries the SCCM server that is specified in the authorization policy to retrieve compliance and last login (check-in) time.

With this information, Cisco ISE updates the compliance status and the lastCheckinTimeStamp of the device in the **Endpoint** list.

If the device is not compliant or not registered with Microsoft SCCM, and a redirect profile is used in the authorization policy, a message is displayed to the user that the device is not compliant, or is not registered with the Microsoft SCCM. After the user acknowledges the message, Cisco ISE can issue a CoA to the Microsoft SCCM registration site. Users are granted access based on the authorization policy and profile.

Microsoft SCCM Server Connection Monitoring

You cannot configure polling intervals for Microsoft SCCM.

Cisco ISE runs an MDM HeartBeat job that verifies connection with the Microsoft SCCM server, and raises alarms if Cisco ISE loses the connection to the Microsoft SCCM server. The HeartBeat job interval cannot be configured.

Policy Set Example for Microsoft System Center Configuration Manager

The following new dictionary entries are used in policies to support Microsoft SCCM.

- **MDM.DaysSinceLastCheckin**: The number of days since a user last checked in or synchronized a device with Microsoft SCCM. The value may range from 1 to 365 days.
- **MDM.UserNotified**: The valid values are **Y** or **N**. The value indicates whether the user was notified that their device is not registered. You can then allow the user limited access to the network and then redirect them to the registration portal, or deny them access to the network.
- **MDM.ServerType**: The valid value is **MDM** for MDM servers and **DM** for desktop device management.

The following is an example of a policy set that supports Microsoft SCCM.

Policy Name	If	Then
SCCM_Comp	Wireless_802.1X AND MDM:MDMServerName EQUALS SccmServer1 AND MDM:DeviceRegisterStatus EQUALS Registered	PermitAccess
SCCM_NonComp_Notify	Wireless_802.1X AND MDM:MDMServerName EQUALS SccmServer1 AND MDM:DeviceCompliantStatus EQUALS NonCompliant AND MDM:UserNotified EQUALS 28	PermitAccess

Policy Name	If	Then
SCCM_NonComp_Days	Wireless_802.1X AND MDM:MDMServerName EQUALS SccmServer1 AND MDM:MDMDeviceCompliantStatus EQUALS Registered AND MDM:DaysSinceLastCheckin EQUALS 28	SCCMRedirect
SCCM_NonComp	Wireless_802.1X AND MDM:MDMServerName EQUALS SccmServer1 AND MDM:DeviceCompliantStatus EQUALS NonCompliant AND MDM:DeviceRegisterStatus EQUALS Registered	SCCMRedirect
SCCM_UnReg_Notify	Wireless_802.1X AND MDM:DeviceRegisterStatus EQUALS Registered AND MDM:UserNotified EQUALS Yes	PermitAccess

Configure the Microsoft System Center Configuration Manager Server for Cisco ISE

Cisco ISE communicates with the Microsoft SCCM server using Windows Management Instrumentation (WMI). Configure WMI on the Windows server running Microsoft SCCM.



Note The user account that you use for Cisco ISE integration must either:

- Be a member of the SMS Admins user group.
- Have the same permissions as the SMS object under the WMI namespace:

```
root\sms\site_<sitecode>
```

where *sitecode* is the Microsoft SCCM site.

Set Permissions when Microsoft Active Directory Users are in Domain Admin Group

For Windows Server 2008 R2, Windows Server 2012, and Windows Server 2012 R2, the Domain Admin group does not have full control of certain registry keys in the Windows operating system by default. The Microsoft Active Directory administrator must give the Microsoft Active Directory user full control permissions on the following registry keys:

- **HKEY_CLASSES_ROOT\CLSID\{76A64158-CB41-11D1-8B02-00600806D9B6}**
- **HKLM\Software\Classes\Wow6432Node\CLSID\{76A64158-CB41-11D1-8B02-00600806D9B6}**

The following Microsoft Active Directory versions require no registry changes:

- Windows 2003
- Windows 2003R2
- Windows 2008

To grant full control, the Microsoft Active Directory admin must first take ownership of the key:

-
- Step 1** Right-click the key icon and choose the **Owner** tab.
- Step 2** Click **Permissions**.
- Step 3** Click **Advanced**.
-

Permissions for Microsoft Active Directory Users Not in Domain Admin Group

For Windows Server 2012 R2, give the Microsoft AD user full control permissions on the following registry keys:

- HKEY_CLASSES_ROOT\CLSID\{76A64158-CB41-11D1-8B02-00600806D9B6}
- HKLM\Software\Classes\Wow6432Node\CLSID\{76A64158-CB41-11D1-8B02-00600806D9B6}

Use the following commands in Windows PowerShell to check if full permission is given to the registry keys:

- `get-acl -path "Microsoft.PowerShell.Core\Registry::HKEY_CLASSES_ROOT\CLSID\{76A64158-CB41-11D1-8B02-00600806D9B6}" | format-list`
- `get-acl -path "hklm:\Software\Classes\Wow6432Node\CLSID\{76A64158-CB41-11D1-8B02-00600806D9B6}" | format-list`

The following permissions are required when a Microsoft AD user is not in the Domain Admin group, but is in the Domain Users group:

- Add registry keys to allow Cisco ISE to connect to the domain controller.
- [Permissions to Use DCOM on the Domain Controller, on page 256](#)
- [Set Permissions for Access to WMI Root and CIMv2 Namespace, on page 258](#)

These permissions are only required for the following Microsoft AD versions:

- Windows 2003
- Windows 2003R2
- Windows 2008
- Windows 2008 R2

- Windows 2012
- Windows 2012 R2
- Windows 2016

Add Registry Keys to Allow Cisco ISE to Connect to the Domain Controller

You must manually add some registry keys to the domain controller to allow Cisco ISE to connect as a domain user, and retrieve login authentication events. An agent is not required on the domain controllers or on any machines in the domain.

The following registry script shows the keys to add. You can copy and paste this into a text file, save the file with a .reg extension, and double click the file to make the registry changes. To add registry keys, the user must be an owner of the root key.

```
Windows Registry Editor Version 5.00

[HKEY_CLASSES_ROOT\CLSID\{76A64158-CB41-11D1-8B02-00600806D9B6}]
"AppID"="{76A64158-CB41-11D1-8B02-00600806D9B6}"

[HKEY_CLASSES_ROOT\AppID\{76A64158-CB41-11D1-8B02-00600806D9B6}]
"DllSurrogate"="  "

[HKEY_CLASSES_ROOT\Wow6432Node\AppID\{76A64158-CB41-11D1-8B02-00600806D9B6}]
"DllSurrogate"="  "
```

Make sure that you include two spaces in the value of the DllSurrogate key. If the registry is manually updated, you must include only the two spaces and do not include the quotes. While updating the registry manually, ensure that quotes are not included for AppID, DllSurrogate, and its values.

Retain the empty lines as shown in the preceding script, including the empty line at the end of the file.

Use the following commands in the Windows command prompt to confirm if the registry keys are created and have the correct values:

- `reg query "HKEY_CLASSES_ROOT\CLSID\{76A64158-CB41-11D1-8B02-00600806D9B6}" /f "{76A64158-CB41-11D1-8B02-00600806D9B6}" /e`
- `reg query HKEY_CLASSES_ROOT\AppID\{76A64158-CB41-11D1-8B02-00600806D9B6} /f " " /e`
- `reg query HKEY_CLASSES_ROOT\Wow6432Node\AppID\{76A64158-CB41-11D1-8B02-00600806D9B6} /f " " /e`

Permissions to Use DCOM on the Domain Controller

The Microsoft Active Directory user who is used for Cisco ISE Passive Identity service must have the permissions to use DCOM on the domain controller server. Configure permissions with the **dcomcnfg** command line tool.

-
- Step 1** Run the **dcomcnfg** tool from the command line.
 - Step 2** Expand **Component Services**.
 - Step 3** Expand **Computers > My Computer**.
 - Step 4** Choose **Action** from the menu bar, click **Properties**, and click **COM Security**.

Step 5 The account that Cisco ISE uses for both access and launch must have Allow permissions. Add the Microsoft Active Directory user to all the four options, **Edit Limits** and **Edit Default** for both **Access Permissions** and **Launch and Activation Permissions**.

Step 6 Allow all local and remote accesses for both **Access Permissions** and **Launch and Activation Permissions**.

Figure 22: Local and Remote Accesses for Access Permissions

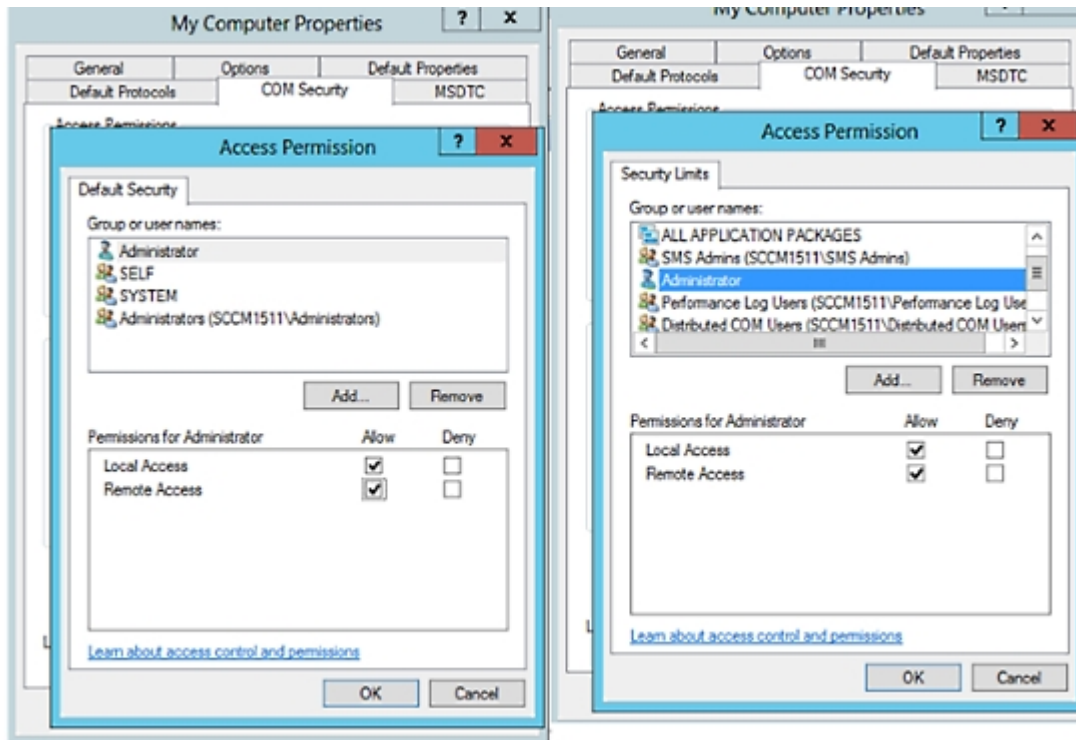
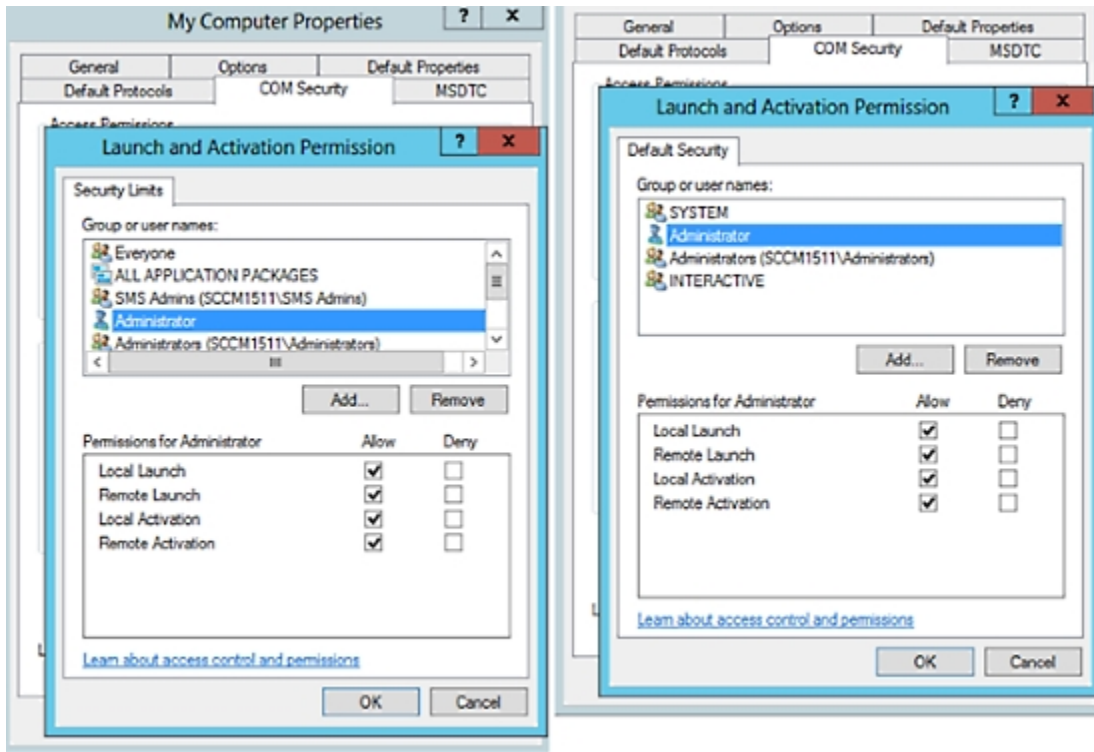


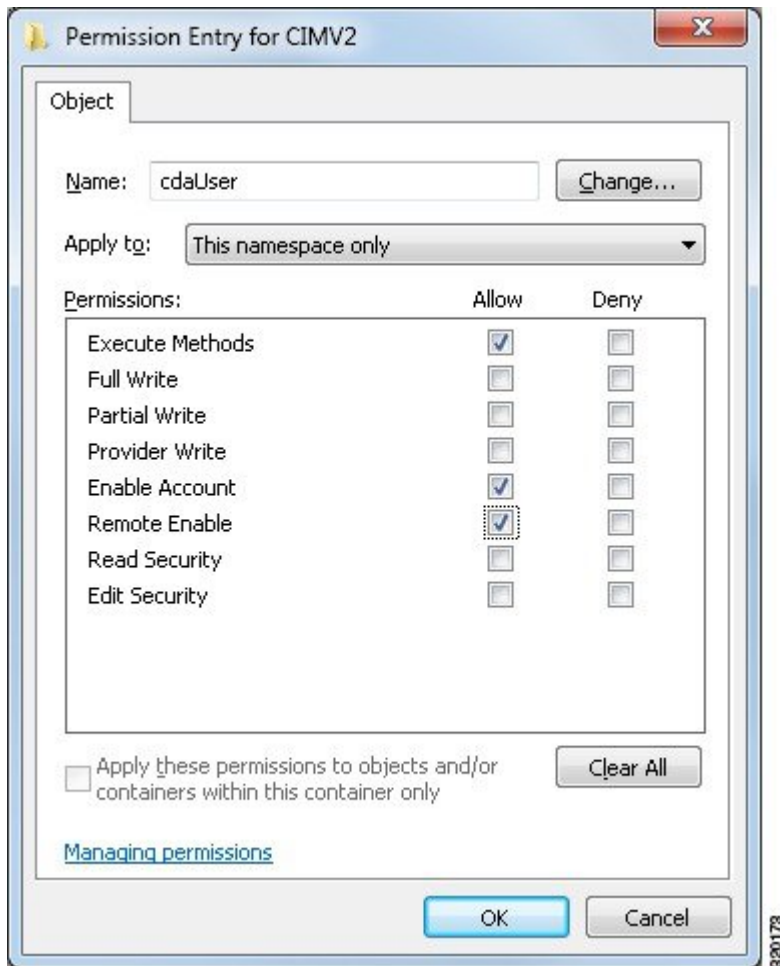
Figure 23: Local and Remote Accesses for Launch and Activation Permissions



Set Permissions for Access to WMI Root and CIMv2 Namespace

By default, Microsoft Active Directory users do not have permissions for the Execute Methods and Remote Enable. You can grant access using the `wmicmgmt.msc` MMC console.

- Step 1** Choose **Start > Run** and enter `wmicmgmt.msc`.
- Step 2** Right-click **WMI Control** and click **Properties**.
- Step 3** Under the **Security** tab, expand **Root** and choose **CIMV2**.
- Step 4** Click **Security**.
- Step 5** Add the Microsoft Active Directory user, and configure the required permissions as shown in the following image.



Open Firewall Ports for WMI Access

The firewall software on the Microsoft Active Directory domain controller may block access to WMI. You can either turn off the firewall, or allow access on a specific IP address (Cisco ISE IP address) to the following ports:

- TCP 135: General RPC Port. When performing asynchronous RPC calls, the service listening on this port tells the client which port the component servicing this request is using.
- UDP 138: NetBIOS Datagram Service
- TCP 139: NetBIOS Session Service
- TCP 445: SMB



Note Cisco ISE supports SMB 2.0.

Higher ports are assigned dynamically, or you can configure them manually. We recommend that you add `%SystemRoot%\System32\dlhhost.exe` as a target. This program manages ports dynamically.

All firewall rules can be assigned to a specific IP address (Cisco ISE IP).

Configure an Authorization Profile for Redirecting Nonregistered Devices

You must configure an authorization profile in Cisco ISE to redirect nonregistered devices for each external MDM server.

Before you begin

- Ensure that you have created an MDM server definition in Cisco ISE. Only after you successfully integrate Cisco ISE with the MDM server is the MDM dictionary populated and you can create an authorization policy using the MDM dictionary attributes.
- Configure ACLs on the Wireless LAN Controller for redirecting unregistered devices.
- If you are using a proxy for Internet connection and the MDM server is part of the internal network, then you have to put the MDM server name or its IP address in the Proxy-Bypass list. Choose **Administration > System > Settings > Proxy** to perform this action.

-
- Step 1** Choose **Policy > Policy Elements > Results > Authorization > Authorization Profiles > Add**.
 - Step 2** Create an authorization profile for redirecting nonregistered devices that are not compliant or registered.
 - Step 3** Enter a name for the authorization profile that matches the MDM server name, in the **Name** field.
 - Step 4** Choose **ACCESS_ACCEPT** from the **Access Type** drop-down list.
 - Step 5** In the **Common Tasks** section, check the **Web Redirection** check box and choose **MDM Redirect** from the drop-down list.
 - Step 6** Choose the name of the ACL that you configured on the wireless LAN controller from the **ACL** drop-down list.
 - Step 7** Choose the MDM portal from the **Value** drop-down list.
 - Step 8** Choose the MDM server that you want to use from the **MDM Server** drop-down list.
 - Step 9** Click **Submit**.
-

What to do next

[Configure Authorization Policy Rules for the Mobile Device Management Use Cases.](#)

Configure Authorization Policy Rules for the Mobile Device Management Use Cases

You must configure authorization policy rules in Cisco ISE to complete the MDM configuration.

Before you begin

- Add the MDM server certificate to the Cisco ISE certificate store.

- Ensure that you have created the MDM server definition in Cisco ISE. Only after you successfully integrate Cisco ISE with the MDM server does the MDM dictionary get populated, and you can create an authorization policy using the MDM dictionary attributes.
- Configure ACLs on the Wireless LAN Controller for redirecting unregistered or noncompliant devices.

Step 1 Choose **Policy > Authorization > Insert New Rule Below**.

Step 2 Choose **Policy > Policy Sets**, and expand the policy set to view the authorization policy rules.

Step 3 Add the following rules:

- **MDM_Un_Registered_Non_Compliant**: For devices that are not yet registered with an MDM server or noncompliant with MDM policies. Once a request matches this rule, the Cisco ISE MDM window is displayed to a user, with information on registering the device with the MDM server.

Note Do not use the **MDM.MDMServerName** condition in this policy. When this condition is used, an endpoint matches the policy only if the endpoint is registered with the MDM server.

- **PERMIT**: If the device is registered with Cisco ISE, registered with MDM, and is compliant with Cisco ISE and MDM policies, it is granted access to the network based on the access control policies configured in Cisco ISE.

The following illustration shows an example of this configuration.

Figure 24: Authorization Policy Rules for the MDM Use Cases



Step 4 Click **Save**.

Wipe or Lock a Device

Cisco ISE allows you to wipe or turn on pin lock for a lost device. You can configure this from the **Endpoints** window.

Step 1 Choose **Work Centers > Network Access > Identities > Endpoints**.

Step 2 Check the check box next to the device that you want to wipe or lock.

Step 3 From the **MDM Actions** drop-down list, choose one of the following options:

- **Full Wipe**: Depending on the MDM vendor, this option either removes the corporate apps or resets the device to the factory settings.
- **Corporate Wipe**: This option removes applications that you have configured in the MDM server policies.
- **PIN Lock**: This option locks the device.

Step 4 Click **Yes** to wipe or lock the device.

View Mobile Device Management Reports

Cisco ISE records all additions, updates, and deletions of MDM server definitions. You can view these events in the **Change Configuration Audit** report, which displays all the configuration changes from any system administrator for a selected time period.

Choose **Operations > Reports > Reports > Audit > Change Configuration Audit**. Check the entries in the **Object Type** and **Object Name** columns for the MDM server you want to review, and click the corresponding **Event** value to view the details of the configuration event.

View Mobile Device Management Logs

You can use the **Debug Log Configuration** window to view Mobile Device Management log messages. Choose **Administration > System > Logging > Debug Log Configuration**. Click the radio button next to a Cisco ISE node and click **Edit**. In the new window displayed, click the radio button next to the component name **external-mdm**, and click **Edit**. The default log level for this component is **INFO**. Choose **DEBUG** or **TRACE** from the corresponding **Log Level** drop-down list, and click **Save**.



CHAPTER 11

Manage Resources

- [Dictionaries and Dictionary Attributes, on page 263](#)
- [RADIUS-Vendor Dictionaries, on page 265](#)

Dictionaries and Dictionary Attributes

Dictionaries are domain-specific catalogs of attributes and allowed values that can be used to define access policies for a domain. An individual dictionary is a homogeneous collection of attribute type. Attributes that are defined in a dictionary have the same attribute type and the type indicates the source or context of a given attribute.

Attribute types can be one of the following:

- MSG_ATTR
- ENTITY_ATTR
- PIP_ATTR

In addition to attributes and allowed values, a dictionary contains information about the attributes such as the name and description, data type, and the default values. An attribute can have one of the following data types: BOOLEAN, FLOAT, INTEGER, IPv4, IPv6, OCTET_STRING, STRING, UNIT32, and UNIT64.

Cisco ISE creates system dictionaries during installation and allows you to create user dictionaries.

System Defined Dictionaries and Dictionary Attributes

Cisco ISE creates system dictionaries during installation that you can find in the System Dictionaries page. System-defined dictionary attributes are read-only attributes. Because of their nature, you can only view existing system-defined dictionaries. You cannot create, edit, or delete system-defined values or any attributes in a system dictionary.

A system-defined dictionary attribute is displayed with the descriptive name of the attribute, an internal name as understood by the domain, and allowed values.

Cisco ISE also creates dictionary defaults for the IETF RADIUS set of attributes that are also a part of the system-defined dictionaries, which are defined by the Internet Engineering Task Force (IETF). You can edit all free IETF RADIUS attribute fields except the ID.

Related Topics

- [Display System Dictionaries and Dictionary Attributes](#), on page 264
[User-Defined Dictionaries and Dictionary Attributes](#), on page 264

Display System Dictionaries and Dictionary Attributes

You cannot create, edit, or delete any system-defined attribute in a system dictionary. You can only view system-defined attributes. You can perform a quick search that is based on a dictionary name and description or an advanced search that is based on a search rule that you define.

-
- Step 1** Choose **Policy > Policy Elements > Dictionaries > System**.
- Step 2** Choose a system dictionary in the System Dictionaries page, and click **View**.
- Step 3** Click **Dictionary Attributes**.
- Step 4** Choose a system dictionary attribute from the list, and click **View**.
- Step 5** Click the **Dictionaries** link to return to the System Dictionaries page.
-

User-Defined Dictionaries and Dictionary Attributes

Cisco ISE displays the user-defined dictionaries that you create in the User Dictionaries page. You cannot modify the values for Dictionary Name or Dictionary Type for an existing user dictionary once created and saved in the system.

You can do the following in the User Dictionaries page:

- Edit and delete user dictionaries.
- Search user dictionaries based on name and description.
- Add, edit, and delete user-defined dictionary attributes in the user dictionaries.
- Delete attributes of the NMAP extension dictionary, using the NMAP scan action. When custom ports are added or deleted in the NMAP Scan Actions page, the corresponding custom ports attributes are added, deleted, or updated in the dictionary.
- Add or remove allowed values for dictionary attributes.

Related Topics

- [Create User-Defined Dictionaries](#), on page 264
[Create User-Defined Dictionary Attributes](#), on page 265

Create User-Defined Dictionaries

You can create, edit, or delete user-defined dictionaries.

-
- Step 1** Choose **Policy > Policy Elements > Dictionaries > User**.
- Step 2** Click **Add**.

- Step 3** Enter the name for the user dictionary, an optional description, and a version for the user dictionary.
- Step 4** Choose the attribute type from the Dictionary Attribute Type drop-down list.
- Step 5** Click **Submit**.

Related Topics

[Create User-Defined Dictionary Attributes](#), on page 265

Create User-Defined Dictionary Attributes

You can add, edit, and delete user-defined dictionary attributes in user dictionaries as well as add or remove allowed values for the dictionary attributes.

-
- Step 1** Choose **Policy > Policy Elements > Dictionaries > User**.
- Step 2** Choose a user dictionary from the User Dictionaries page, and click **Edit**.
- Step 3** Click **Dictionary Attributes**.
- Step 4** Click **Add**.
- Step 5** Enter the name for an attribute name, an optional description, and an internal name for the dictionary attribute.
- Step 6** Choose a data type from the Data Type drop-down list.
- Step 7** Click **Add** to configure the name, allowed value, and set the default status in the Allowed Values table.
- Step 8** Click **Submit**.
-

RADIUS-Vendor Dictionaries

Cisco ISE allows you to define a set of RADIUS-vendor dictionaries, and define a set of attributes for each one. Each vendor definition in the list contains the vendor name, the vendor ID, and a brief description.

Cisco ISE provides you the following RADIUS-vendor dictionaries by default:

- Airespace
- Cisco
- Cisco-BBSM
- Cisco-VPN3000
- Microsoft

The RADIUS protocol supports these vendor dictionaries, and the vendor-specific attributes that can be used in authorization profiles and in policy conditions.

Related Topics

[Create RADIUS-Vendor Dictionaries](#), on page 266

[Create RADIUS-Vendor Dictionary Attributes](#), on page 266

Create RADIUS-Vendor Dictionaries

You can also create, edit, delete, export, and import RADIUS-vendor dictionaries.

-
- Step 1** Choose **Policy > Policy Elements > Dictionaries > System > Radius > Radius Vendors**.
 - Step 2** Click **Add**.
 - Step 3** Enter a name for the RADIUS-vendor dictionary, an optional description, and the vendor ID as approved by the Internet Assigned Numbers Authority (IANA) for the RADIUS vendor.
 - Step 4** Choose the number of bytes taken from the attribute value to specify the attribute type from the Vendor Attribute Type Field Length drop- down list. Valid values are 1, 2, and 4. The default value is 1.
 - Step 5** Choose the number of bytes taken from the attribute value to specify the attribute length from the Vendor Attribute Size Field Length drop-down list. Valid values are 0 and 1. The default value is 1.
 - Step 6** Click **Submit**.
-

Related Topics

[Create RADIUS-Vendor Dictionary Attributes](#), on page 266

Create RADIUS-Vendor Dictionary Attributes

You can create, edit, and delete RADIUS vendor attributes that Cisco ISE supports. Each RADIUS-vendor attribute has a name, data type, description, and direction, which specifies whether it is relevant to requests only, responses only, or both.

-
- Step 1** Choose **Policy > Policy Elements > Dictionaries > System > Radius > Radius Vendors**.
 - Step 2** Choose a RADIUS-vendor dictionary from the RADIUS vendor dictionaries list, and click **Edit**.
 - Step 3** Click **Dictionary Attributes**, and then click **Add**.
 - Step 4** Enter the attribute name for the RADIUS vendor attribute and an optional description.
 - Step 5** Choose the data type from the Data Type drop-down list.
 - Step 6** Check the **Enable MAC option** check box.
 - Step 7** Choose the direction that applies to RADIUS requests only, RADIUS responses only, or both from the Direction drop-down list.
 - Step 8** Enter the vendor attribute ID in the ID field.
 - Step 9** Check the **Allow Tagging** check box.
 - Step 10** Check the **Allow multiple instances of this attribute in a profile** check box.
 - Step 11** Click **Add** to add the allowed value for the vendor attribute in the Allowed Values table.
 - Step 12** Click **Submit**.
-

HP RADIUS IETF Service Type Attributes

Cisco ISE introduces two new values for the RADIUS IETF Service Type attribute. The RADIUS IETF service type attribute is available in **Policy > Policy Elements > Dictionaries > System > RADIUS > IETF**.

You can use these two values in policy conditions. These two values are specifically designed for HP devices to understand permissions of the user.

Enumeration Name	Enumeration Value
HP-Oper	252
HP-User	255



CHAPTER 12

Logging Mechanism

- [Cisco ISE Logging Mechanism, on page 269](#)
- [Cisco ISE System Logs, on page 270](#)
- [Configure Remote Syslog Collection Locations, on page 270](#)
- [Cisco ISE Message Codes, on page 272](#)
- [Cisco ISE Message Catalogs, on page 272](#)
- [Debug Logs, on page 273](#)
- [Endpoint Debug Log Collector, on page 274](#)
- [Collection Filters, on page 275](#)

Cisco ISE Logging Mechanism

Cisco ISE provides a logging mechanism that is used for auditing, fault management, and troubleshooting. The logging mechanism helps you to identify fault conditions in deployed services and troubleshoot issues efficiently. It also produces logging output from the monitoring and troubleshooting primary node in a consistent fashion.

You can configure a Cisco ISE node to collect the logs in the local systems using a virtual loopback address. To collect logs externally, you configure external syslog servers, which are called targets. Logs are classified into various predefined categories. You can customize logging output by editing the categories with respect to their targets, severity level, and so on.

As a best practice, do not configure network devices to send syslogs to a Cisco ISE Monitoring and Troubleshooting (MnT) node as this could result in the loss of some Network Access Device (NAD) syslogs, and overloads the MnT servers resulting in loading issues.



Note If the Monitoring node is configured as the syslog server for a network device, ensure that the logging source sends the correct network access server (NAS) IP address in the following format:

<message_number>sequence_number: NAS_IP_address: timestamp: syslog_type: <message_text>

Otherwise, this might impact functionalities that depend on the NAS IP address.

Configure Syslog Purge Settings

Use this process to set local log-storage periods and to delete local logs after a certain period of time.

-
- Step 1** Choose **Administration > System > Logging > Local Log Settings**.
- Step 2** In the **Local Log Storage Period** field, enter the maximum number of days to keep the log entries in the configuration source.
- Logs may be deleted earlier than the configured **Local Log Storage Period** if the size of the localStore folder reaches 97 GB.
- Step 3** Click **Delete Logs Now** to delete the existing log files at any time before the expiration of the storage period.
- Step 4** Click **Save**.
-

Cisco ISE System Logs

In Cisco ISE, system logs are collected at locations called logging targets. Targets refer to the IP addresses of the servers that collect and store logs. You can generate and store logs locally, or you can use the FTP facility to transfer them to an external server. Cisco ISE has the following default targets, which are dynamically configured in the loopback addresses of the local system:

- LogCollector—Default syslog target for the Log Collector.
- ProfilerRadiusProbe—Default syslog target for the Profiler Radius Probe.

By default, AAA Diagnostics subcategories and System Diagnostics subcategories logging targets are disabled during a fresh Cisco ISE installation or an upgrade to reduce the disk space. You can configure logging targets manually for these subcategories but local logging for these subcategories are always enabled.

You can use the default logging targets that are configured locally at the end of the Cisco ISE installation or you can create external targets to store the logs.



Note If a syslog server is configured in a distributed deployment, syslog messages are sent directly from the authenticating PSNs to the syslog server and not from the MnT node.

Related Topics

[Cisco ISE Message Codes](#), on page 272

Configure Remote Syslog Collection Locations

You can use the web interface to create remote syslog server targets to which system log messages are sent. Log messages are sent to the remote syslog server targets in accordance with the syslog protocol standard (see RFC-3164). The syslog protocol is an unsecure UDP.

A message is generated when an event occurs. An event may be one that displays a status, such as a message displayed when exiting a program, or an alarm. There are different types of event messages generated from

multiple facilities such as the kernel, mail, user level, and so on. An event message is associated with a severity level, which allows an administrator to filter the messages and prioritize it. Numerical codes are assigned to the facility and the severity level. A syslog server is an event message collector and collects event messages from these facilities. The administrator can select the event message collector to which messages will be forwarded based on their severity level.

The UDP syslog (log collector) is the default remote logging target. When you disable this logging target, it no longer functions as a log collector and is removed from the **Logging Categories** window. When you enable this logging target, it becomes a log collector in the **Logging Categories** window.



Note Any changes to the default remote logging target **SecureSyslogCollector** results in the restart of the Cisco ISE Monitoring & Troubleshooting Log Processor service.

Step 1 Choose **Administration** > **System** > **Logging** > **Remote Logging Targets**.

Step 2 Click **Add**.

Step 3 Enter the required details.

Step 4 Click **Save**.

Step 5 Go to the Remote Logging Targets page and verify the creation of the new target.

The logging targets can then be mapped to each of the logging categories below. The PSN nodes send the relevant logs to the remote logging targets depending on the services that are enabled on those nodes.

- AAA Audit
- AAA Diagnostics
- Accounting
- External MDM
- Passive ID
- Posture and Client Provisioning Audit
- Posture and Client Provisioning Diagnostics
- Profiler

Logs of the following categories are sent by all nodes in the deployment to the logging targets:

- Administrative and Operational Audit
 - System Diagnostics
 - System Statistics
-

Cisco ISE Message Codes

A logging category is a bundle of message codes that describe a function, a flow, or a use case. In Cisco ISE, each log is associated with a message code that is bundled with the logging categories according to the log message content. Logging categories help describe the content of the messages that they contain.

Logging categories promote logging configuration. Each category has a name, target, and severity level that you can set, as per your application requirement.

Cisco ISE provides predefined logging categories for services, such as Posture, Profiler, Guest, AAA (authentication, authorization, and accounting), and so on, to which you can assign log targets.

For the logging category **Passed Authentications**, the option to allow local logging is disabled by default. Enabling local logging for this category will result in high utilization of operational space, and fill prrt-server.log along with the iseLocalStore.log.

If you choose to enable local logging for **Passed Authentications**, go to **Administration > System > Logging > Logging Categories**, click **Passed Authentications** from the category section, and check the check box against **Local Logging**.

Related Topics

[Set Severity Levels for Message Codes](#), on page 272

Set Severity Levels for Message Codes

You can set the log severity level and choose logging targets where the logs of selected categories will be stored.

-
- Step 1** Choose **Administration > System > Logging > Logging Categories**.
 - Step 2** Click the radio button next to the category that you want to edit, and click **Edit**.
 - Step 3** Modify the required field values.
 - Step 4** Click **Save**.
 - Step 5** Go to the Logging Categories page and verify the configuration changes that were made to the specific category.
-

Cisco ISE Message Catalogs

You can use the Message Catalog page to view all possible log messages and the descriptions. Choose **Administration > System > Logging > Message Catalog**.

The Log Message Catalog page appears, from which you can view all possible log messages that can appear in your log files. The data available in this page are for display only.

See [Cisco ISE Syslogs](#) for a comprehensive list of the syslog messages sent by Cisco ISE, what they mean, and how they are recorded in local and remote targets.

Debug Logs

Debug logs capture bootstrap, application configuration, runtime, deployment, monitoring, reporting, and public key infrastructure (PKI) information. Critical and warning alarms for the past 30 days and info alarms for the past 7 days are included in the debug logs.

You can configure the debug log severity level for individual components.

You can use the Reset to Default option for a node or component to reset the log level back to factory-shipped default values.

You can store the debug logs in the local server.



Note Debug log configuration is not saved when a system is restored from a backup or upgraded.

Related Topics

[Configure Debug Log Severity Level](#), on page 273

View Logging Components for a Node

Step 1 Choose **Administration > System > Logging > Debug Log Configuration**.

Step 2 Select the node for which you want to view the logging components, and then click **Edit**.

The Debug Level Configuration page appears. You can view the following details:

- List of logging components based on the services that are running on the selected node
- Description for each component
- Current log level that is set for the individual components

Related Topics

[Configure Debug Log Severity Level](#), on page 273

Configure Debug Log Severity Level

You can configure the severity levels for the debug logs.

Step 1 Choose **Administration > System > Logging > Debug Log Configuration**.

Step 2 Select the node, and then click **Edit**.

The Debug Log Configuration page displays a list of components based on the services that are running in the selected node and the current log level that is set for the individual components.

You can use the **Reset to Default** option for a node or component to reset the log level back to factory-shipped default values.

Step 3 Select the component for which you want to configure the log severity level, and then click **Edit**. Choose the desired log severity level from the **Log Level** drop-down list, and click **Save**.

Note Changing the log severity level of the runtime-AAA component changes the log level of its subcomponent prrt-JNI as well. A change in subcomponent log level does not affect its parent component.

Related Topics

[Configure Debug Log Severity Level](#), on page 273

[Cisco ISE Debug Logs](#), on page 889

Endpoint Debug Log Collector

To troubleshoot issues with a specific endpoint, you can download debug logs for that particular endpoint based on its IP address or MAC address. The logs from the various nodes in your deployment specific to that particular endpoint get collected in a single file thus helping you troubleshoot your issue quickly and efficiently. You can run this troubleshooting tool only for one endpoint at a time. The log files are listed in the GUI. You can download the logs for an endpoint from a single node or from all the nodes in your deployment.

Download Debug Logs for a Specific Endpoint

To troubleshoot issues related to a specific endpoint in your network, you can use the Debug Endpoint tool from the Admin portal. Alternatively, you can run this tool from the Authentications page. Right-click the Endpoint ID from the Authentications page and click **Endpoint Debug**. This tool provides all debug information for all services related to the specific endpoint in a single file.

Before you begin

You need the IP address or MAC address of the endpoint whose debug logs you want to collect.

Step 1 Choose **Operations > Troubleshoot > Diagnostic Tools > General Tools > Endpoint Debug**.

Step 2 Click the **MAC Address** or **IP** radio button and enter the MAC or IP address of the endpoint.

Step 3 Check the **Automatic disable after *n* Minutes** check box if you want to stop log collection after a specified amount of time. If you check this check box, you must enter a time between 1 and 60 minutes.

The following message appears: "Endpoint Debug degrades the deployment performance. Would you like to continue?"

Step 4 Click **Continue** to collect the logs.

Step 5 Click **Stop** when you want to manually stop the log collection.

Related Topics

[Endpoint Debug Log Collector](#), on page 274

Collection Filters

You can configure the Collection Filters to suppress the syslog messages being sent to the monitoring and external servers. The suppression can be performed at the Policy Services Node levels based on different attribute types. You can define multiple filters with specific attribute type and a corresponding value.

Before sending the syslog messages to monitoring node or external server, Cisco ISE compares these values with fields in syslog messages to be sent. If any match is found, then the corresponding message is not sent.

Configure Collection Filters

You can configure multiple collection filters based on various attribute types. It is recommended to limit the number of filters to 20. You can add, edit, or delete a collection filter.

-
- Step 1** Choose **Administration** > **System** > **Logging** > **Collection Filters**.
- Step 2** Click **Add**.
- Step 3** Choose the **Filter Type** from the following list:
- User Name
 - MAC Address
 - Policy Set Name
 - NAS IP Address
 - Device IP Address
- Step 4** Enter the corresponding **Value** for the filter type you have selected.
- Step 5** Choose the **Result** from the drop-down list. The result can be All, Passed, or Failed.
- Step 6** Click **Submit**.
-

Related Topics

[Collection Filters](#), on page 275

[Event Suppression Bypass Filter](#), on page 275

Event Suppression Bypass Filter

Cisco ISE allows you to set filters to suppress some syslog messages from being sent to the Monitoring node and other external servers using the Collection Filters. At times, you need access to these suppressed log messages. Cisco ISE now provides you an option to bypass the event suppression based on a particular attribute such as username for a configurable amount of time. The default is 50 minutes, but you can configure the duration from 5 minutes to 480 minutes (8 hours). After you configure the event suppression bypass, it takes effect immediately. If the duration that you have set elapses, then the bypass suppression filter expires.

You can configure a suppression bypass filter from the Collection Filters page in the Cisco ISE user interface. Using this feature, you can now view all the logs for a particular identity (user) and troubleshoot issues for that identity in real time.

You can enable or disable a filter. If the duration that you have configured in a bypass event filter elapses, the filter is disabled automatically until you enable it again. Cisco ISE captures these configuration changes in the Change Configuration Audit Report. This report provides information on who configured an event suppression or a bypass suppression and the duration of time for which the event was suppressed or the suppression bypassed.



CHAPTER 13

Backup and Restore Operations

- [Backup Data Type, on page 277](#)
- [Backup and Restore Repositories, on page 278](#)
- [On-Demand and Scheduled Backups, on page 280](#)
- [Cisco ISE Restore Operation, on page 285](#)
- [Export Authentication and Authorization Policy Configuration, on page 292](#)
- [Synchronize Primary and Secondary Nodes in a Distributed Environment, on page 292](#)
- [Recovery of Lost Nodes in Standalone and Distributed Deployments, on page 293](#)

Backup Data Type

Cisco ISE allows you to back up data from the primary PAN and from the Monitoring node. Backup can be done from the CLI or user interface.

Cisco ISE allows you to back up the following type of data:

- **Configuration data**—Contains both application-specific and Cisco ADE operating system configuration data. Backup can be done via the primary PAN using the GUI or CLI.
- **Operational Data**—Contains monitoring and troubleshooting data. Backup can be done via the primary PAN GUI or using the CLI for the Monitoring node.

When Cisco ISE is run on VMware, VMware snapshots are not supported for backing up ISE data.



Note Cisco ISE does not support VMware snapshots for backing up ISE data because a VMware snapshot saves the status of a VM at a given point in time. In a multinode Cisco ISE deployment, data in all the nodes are continuously synchronized with current database information. Restoring a snapshot might cause database replication and synchronization issues. Cisco recommends that you use the backup functionality included in Cisco ISE for archival and restoration of data.

Using VMware snapshots or any third-party backup service to back up Cisco ISE data might result in interrupting Cisco ISE services. When a backup is initiated by VMware or any other third-party backup service like CommVault SAN level backup, it quiesces the file system to maintain crash consistency, which can cause your Cisco ISE functionalities to freeze. A reboot is required to resume the services on your Cisco ISE deployment.

Restore operation, can be performed with the backup files of previous versions of Cisco ISE and restored on a later version. For example, if you have a backup from an ISE node from Cisco ISE, Release 1.3 or 1.4, you can restore it on Cisco ISE, Release 2.1.



Note While recreating a deployment after backing up and restoring data, a **Context Visibility Reset** of both Primary PAN and Secondary PAN are required to ensure that data on both the nodes are synced.

Cisco ISE, Release 2.2 supports restore from backups obtained from Release 1.4 and later.

Backup and Restore Repositories

Cisco ISE allows you to create and delete repositories through the administrator portal. You can create the following types of repositories:

- DISK
- FTP
- SFTP
- NFS
- CD-ROM
- HTTP
- HTTPS



Note Repositories are local to each device.

You should have a repository size of 10 GB for small deployments (100 endpoints or less), 100 GB for medium deployments, and 200 GB for large deployments.

Related Topics

[Create Repositories](#), on page 278

[On-Demand and Scheduled Backups](#), on page 280

Create Repositories

You can use the CLI and GUI to create repositories. We recommend that you use the GUI due to the following reasons:

- Repositories that are created through the CLI are saved locally and do not get replicated to the other deployment nodes. These repositories do not get listed in the GUI's repository page.
- Repositories that are created on the primary PAN get replicated to the other deployment nodes.

The keys are generated only at the primary PAN on GUI, and so during upgrade you need to generate the keys again at GUI of new primary admin and export it to the SFTP server. If you remove the nodes from your deployment, you need to generate the keys on GUI of non-admin nodes and export it to the SFTP server.

You can configure an SFTP repository in Cisco ISE with RSA public key authentication. Instead of using an administrator-created password to encrypt the database and logs, you can choose the RSA public key authentication that uses secure keys. In case of SFTP repository created with RSA public key, the repositories created through the GUI do not get replicated in the CLI and the repositories created through the CLI do not get replicated in the GUI. To configure same repository on the CLI and GUI, generate RSA public keys on both CLI and GUI and export both the keys to the SFTP server.

Before you begin

- To perform the following task, you must have the privileges of either a Super Admin or System Admin.
- If you want to create an SFTP repository with RSA public key authentication, perform the following steps:
 - Enable RSA public key authentication in the SFTP repository.
 - You must log in as the Admin CLI user. Enter the host key of the SFTP server from the Cisco ISE CLI using the **crypto host_key add** command. The host key string should match the hostname that you enter in the **Path** field of the repository configuration page.
 - Generate the key pairs and export the public key to your local system from the GUI. From the Cisco ISE CLI, generate the key pairs using the **crypto key generate rsa passphrase test123** command, where, passphrase must be greater than four letters, and export the keys to any repository (local disk or any other configured repository).
 - Copy the exported RSA public key to the PKI-enabled SFTP server and add it to the "authorized_keys" file.

-
- Step 1** Choose **Administration > System > Maintenance > Repository**.
 - Step 2** Click **Add** to add a new repository.
 - Step 3** Enter the values as required to set up new repository. See [Repository Settings, on page 984](#) for a description of the fields.
 - Step 4** Click **Submit** to create the repository.
 - Step 5** Verify that the repository is created successfully by clicking **Repository** from the **Operations** navigation pane on the left or click the **Repository List** link at the top of **Repository** window to go to the repository listing page.
-

What to do next

- Ensure that the repository that you have created is valid. You can do so from the **Repository Listing** window. Select the corresponding repository and click **Validate**. Alternatively, you can execute the following command from the Cisco ISE command-line interface:

```
show repository repository_name
```

where *repository_name* is the name of the repository that you have created.



Note If the path that you provided while creating the repository does not exist, then you will get the following error:

```
%Invalid Directory
```

- Run an on-demand backup or schedule a backup.

Related Topics

[Perform an On-Demand Backup](#), on page 281

[Schedule a Backup](#), on page 283

Enable RSA Public Key Authentication in SFTP Repository

In the SFTP server, each node must have two RSA public keys, one each for CLI and for GUI. To enable RSA public key authentication in SFTP repository, perform the following steps:



Note After you enable RSA public key authentication in SFTP repository, you will not be able to log in using SFTP credentials. You can either use PKI-based authentication or credential-based authentication. If you want to use credential-based authentication again, you must remove the public key pair from the SFTP server.

Step 1 Log in to SFTP server with an account that has permission to edit the `/etc/ssh/sshd_config` file.

Note The location of the `sshd_config` file might vary based on the operating system installation.

Step 2 Enter the `vi /etc/ssh/sshd_config` command.

The contents of the `sshd_config` file is listed.

Step 3 Remove the `"#"` symbol from the following lines to enable RSA public key authentication:

- `RSAAuthentication yes`
- `PubkeyAuthentication yes`

Note If `Public Auth Key` is `no`, change it to `yes`.

- `AuthorizedKeysFile ~/.ssh/authorized_keys`

On-Demand and Scheduled Backups

You can configure on-demand backups of the primary PAN and the primary monitoring node. Perform an on-demand backup when you want to back up data immediately.

You can schedule system-level backups to run once, daily, weekly, or monthly. Because backup operations can be lengthy, you can schedule them so they are not a disruption. You can schedule a backup from the Admin portal.



Note If you are using the internal CA, you should use the CLI to export certificates and keys. Backup using in the administration portal does not back up the CA chain.

For more information, see the "Export Cisco ISE CA Certificates and Keys" section in the "Basic Setup" chapter *Cisco Identity Services Engine Administrator Guide* .



Note Configurational and operational backups on Cisco ISE can overload your system for a short time. This expected behaviour of temporary system overload will depend on the configuration and monitoring database size of your system.

Related Topics

[Schedule a Backup](#), on page 283

[Perform an On-Demand Backup](#), on page 281

[Backup Using the CLI](#), on page 284

[Backup History](#), on page 284

[Backup Failures](#), on page 285

[Cisco ISE Restore Operation](#), on page 285

[Maintenance Settings](#), on page 983

Perform an On-Demand Backup

You can perform an On-demand backup to instantly back up the configuration or monitoring (operational) data. The restore operation restores Cisco ISE to the configuration state that existed at the time of obtaining the backup.



Important When performing a back up and restore, the restore overwrites the list of trusted certificates on the target system with the list of certificates from the source system. It is critically important to note that backup and restore functions do not include private keys associated with the Internal Certificate Authority (CA) certificates.

If you are performing a back up and restore from one system to another, you have to choose from one of these options to avoid errors:

- **Option 1:**

Export the CA certificates from the source ISE node through the CLI and import them in to the target system through the CLI.

Pros: Any certificates issued to endpoints from the source system will continue to be trusted. Any new certificates issued by the target system will be signed by the same keys.

Cons: Any certificates that have been issued by the target system prior to the restore function will not be trusted and will need to be re-issued.

- **Option 2:**

After the restore process, generate all new certificates for the internal CA.

Pros: This option is the recommended and clean method, where neither the original source certificates or the original target certificates will be used. Certificates issued by the original source system continues to be trusted.

Cons: Any certificates that have been issued by the target system prior to the restore function will not be trusted and will need to be re-issued.

Before you begin

- Before you perform an on-demand backup, you should have a basic understanding of the backup data types in Cisco ISE.
- Ensure that you have created repositories for storing the backup files.
- Do not back up using a local repository. You cannot back up the monitoring data in the local repository of a remote Monitoring node.
- Ensure that you perform all certificate-related changes before you obtain the backup.
- To perform the following task, you must be a Super Admin or System Admin.



Note For backup and restore operations, the following repository types are not supported: CD-ROM, HTTP, HTTPS, or TFTP. This is because, either these repository types are read-only or the protocol does not support file listing. To restore a backup, choose the repository and click **Restore**.

Related Topics

[Backup Data Type](#), on page 277

[Create Repositories](#), on page 278

[Backup and Restore Repositories](#), on page 278

[Schedule a Backup](#), on page 283

[Backup Using the CLI](#), on page 284

[Backup History](#), on page 284

[Backup Failures](#), on page 285

[Cisco ISE Restore Operation](#), on page 285

[Export Authentication and Authorization Policy Configuration](#), on page 292

Schedule a Backup

You can perform an On-demand backup to instantly back up the configuration or monitoring (operational) data. The restore operation restores Cisco ISE to the configuration state that existed at the time of obtaining the backup.



Important

When performing a back up and restore, the restore overwrites the list of trusted certificates on the target system with the list of certificates from the source system. It is critically important to note that backup and restore functions do not include private keys associated with the Internal Certificate Authority (CA) certificates.

If you are performing a back up and restore from one system to another, you will have to choose from one of these options to avoid errors:

• Option 1:

Export the CA certificates from the source ISE node through the CLI and import them in to the target system through the CLI.

Pros: Any certificates issued to endpoints from the source system will continue to be trusted. Any new certificates issued by the target system will be signed by the same keys.

Cons: Any certificates that have been issued by the target system prior to the restore function will not be trusted and will need to be re-issued.

• Option 2:

After the restore process, generate all new certificates for the internal CA.

Pros: This option is the recommended and clean method, where the original source certificates or the original target certificates will be used. Certificates issued by the original source system will continue to be trusted.

Cons: Any certificates that have been issued by the target system prior to the restore function will not be trusted and will need to be re-issued.

Before you begin

- Before you schedule a backup, you should have a basic understanding of the backup data types in Cisco ISE.
- Ensure that you have configured repositories.
- Do not back up using a local repository. You cannot back up the monitoring data in the local repository of a remote Monitoring node.

- To perform the following task, you must be a Super Admin or System Admin.
- If you have upgraded to Cisco ISE 1.2 from Cisco ISE 1.1 or earlier releases, you should reconfigure your scheduled backups. See the Known Upgrade Issues section in the *Cisco Identity Services Engine Upgrade Guide, Release 1.2*.



Note For backup and restore operations, the following repository types are not supported: CD-ROM, HTTP, HTTPS, or TFTP. This is because, either these repository types are read-only or the protocol does not support file listing.

-
- Step 1** Choose **Administration** > **System** > **Backup and Restore**.
- Step 2** Click **Create** to schedule a Configuration or an Operational backup.
- Step 3** Enter the values as required to schedule a backup.
- Step 4** Click **Save** to schedule the backup.
- Step 5** Click the **Refresh** link at the top of this page to see the scheduled backup list.

You can create only one schedule at a time for a Configuration or Operational backup. You can enable or disable a scheduled backup, but you cannot delete it.

Related Topics

- [Backup Data Type](#), on page 277
- [On-Demand and Scheduled Backups](#), on page 280
- [Perform an On-Demand Backup](#), on page 281
- [Backup Using the CLI](#), on page 284
- [Backup History](#), on page 284
- [Backup Failures](#), on page 285
- [Backup and Restore Repositories](#), on page 278

Backup Using the CLI

Although you can schedule backups both from the CLI as well as the GUI, it is recommended to use GUI. However, you can perform operational backup on the secondary monitoring node only from the CLI.

Backup History

Backup history provides basic information about scheduled and on-demand backups. It lists the name of the backup, backup file size, repository where the backup is stored, and time stamp that indicates when the backup was obtained. This information is available in the Operations Audit report and on the Backup and Restore page in the History table.

For failed backups, Cisco ISE triggers an alarm. The backup history page provides the failure reason. The failure reason is also cited in the Operations Audit report. If the failure reason is missing or is not clear, you can run the **backup-logs** command from the Cisco ISE CLI and look at the ADE.log for more information.

While the backup operation is in progress, you can use the **show backup status** CLI command to check the progress of the backup operation.

Backup history is stored along with the Cisco ADE operating system configuration data. It remains there even after an application upgrade and are only removed when you reimage the PAN.

Backup Failures

If backup fails, check the following:

-
- Make sure that no other backup is running at the same time.
- Check the available disk space for the configured repository.
 - Monitoring (operational) backup fails if the monitoring data takes up more than 75% of the allocated monitoring database size. For example, if your Monitoring node is allocated 600 GB, and the monitoring data takes up more than 450 GB of storage, then monitoring backup fails.
 - If the database disk usage is greater than 90%, a purge occurs to bring the database size to less than or equal to 75% of its allocated size.
- Verify if a purge is in progress. Backup and restore operations will not work while a purge is in progress.
- Verify if the repository is configured correctly.

Cisco ISE Restore Operation

You can restore configuration data on a primary or standalone administration node. After you restore data on the Primary PAN, you must manually synchronize the secondary nodes with the Primary PAN.

The process for restoring the operational data is different depending on the type of deployment.



Note The new backup/restore user interface in Cisco ISE makes use of meta-data in the backup filename. Therefore, after a backup completes, you should not modify the backup filename manually. If you manually modify the backup filename, the Cisco ISE backup/restore user interface will not be able to recognize the backup file. If you have to modify the backup filename, you should use the Cisco ISE CLI to restore the backup.

Related Topics

[Restoration of Configuration or Monitoring \(Operational\) Backup from the CLI](#), on page 287

[Restore Configuration Backups from the GUI](#), on page 289

[Restoration of Monitoring Database](#), on page 290

[Synchronize Primary and Secondary Nodes in a Distributed Environment](#), on page 292

Guidelines for Data Restoration

Following are guidelines to follow when you restore Cisco ISE backup data.

- Cisco ISE allows you to obtain a backup from an ISE node (A) and restore it on another ISE node (B), both having the same host names (but different IP addresses). However, after you restore the backup on node B, do not change the hostname of node B because it might cause issues with certificates and portal group tags.
- If you obtain a backup from the Primary PAN in one timezone and try to restore it on another Cisco ISE node in another timezone, the restore process might fail. This failure happens if the timestamp in the backup file is later than the system time on the Cisco ISE node on which the backup is restored. If you restore the same backup a day after it was obtained, then the timestamp in the backup file is in the past and the restore process succeeds.
- When you restore a backup on the Primary PAN with a different hostname than the one from which the backup was obtained, the Primary PAN becomes a standalone node. The deployment is broken and the secondary nodes become nonfunctional. You must make the standalone node the primary node, reset the configuration on the secondary nodes, and reregister them with the primary node. To reset the configuration on Cisco ISE nodes, enter the following command from the Cisco ISE CLI:
 - **application reset-config ise**
- We recommend that you do not change the system timezone after the initial Cisco ISE installation and setup.
- If you changed the certificate configuration on one or more nodes in your deployment, you must obtain another backup to restore the data from the standalone Cisco ISE node or Primary PAN. Otherwise, if you try to restore data using an older backup, the communication between the nodes might fail.
- After you restore the configuration backup on the Primary PAN, you can import the Cisco ISE CA certificates and keys that you exported earlier.



Note If you did not export the Cisco ISE CA certificates and keys, then after you restore the configuration backup on the Primary PAN, generate the root CA and subordinate CAs on the Primary PAN and Policy Service Nodes (PSNs).

- If you are trying to restore a platinum database without using the correct FQDN (FQDN of a platinum database), you need to regenerate the CA certificates. (choose **Administration > Certificates > Certificate Signing Requests > Replace ISE Root CA certificate chain**). However, If you restore the platinum database with the correct FQDN, note that the CA certificates regenerated automatically.
- You need a data repository, which is the location where Cisco ISE saves your backup file. You must create a repository before you can run an on-demand or scheduled backup.
- If you have a standalone administration node that fails, you must run the configuration backup to restore it. If the Primary PAN fails, you can use the distributed setup to promote your Secondary Administration Node to become the primary. You can then restore data on the Primary PAN after it comes up.



Note Cisco ISE also provides the **backup-logs** CLI command that you can use to collect log and configuration files for troubleshooting purposes.

Restoration of Configuration or Monitoring (Operational) Backup from the CLI

To restore configuration data through the Cisco ISE CLI, use the **restore** command in the EXEC mode. Use the following command to restore data from a configuration or operational backup:

restore *filename* **repository** *repository-name* **encryption-key** **hash|plain** *encryption-key name* **include-adeos**

Syntax Description

restore	Type this command to restore data from a configuration or operational backup.
<i>filename</i>	Name of the backed-up file that resides in the repository. Supports up to 120 alphanumeric characters. Note You must add the .tar.gpg extension after the filename (for example, myfile.tar.gpg).
repository	Specifies the repository that contains the backup.
<i>repository-name</i>	Name of the repository you want to restore the backup from.
encryption-key	(Optional) Specifies user-defined encryption key to restore backup.
hash	Hashed encryption key for restoring backup. Specifies an encrypted (hashed) encryption key that follows. Supports up to 40 characters.
plain	Plaintext encryption key for restoring backup. Specifies an unencrypted plaintext encryption key that follows. Supports up to 15 characters.
<i>encryption-key name</i>	Enter the encryption key.
include-adeos	(Optional, applicable only for configuration backup) Enter this command operator parameter if you want to restore ADE-OS configuration from a configuration backup. When you restore a configuration backup, if you do not include this parameter, Cisco ISE restores only the Cisco ISE application configuration data.

Defaults

No default behavior or values.

Command Modes

EXEC

Usage Guidelines

When you use restore commands in Cisco ISE, the Cisco ISE server restarts automatically.

The encryption key is optional while restoring data. To support restoring earlier backups where you have not provided encryption keys, you can use the **restore** command without the encryption key.

Examples

```
ise/admin# restore mybackup-100818-1502.tar.gpg repository myrepository encryption-key plain
Lab12345
Restore may require a restart of application services. Continue? (yes/no) [yes] ? yes
Initiating restore. Please wait...
ISE application restore is in progress.
This process could take several minutes. Please wait...
Stopping ISE Application Server...
Stopping ISE Monitoring & Troubleshooting Log Processor...
Stopping ISE Monitoring & Troubleshooting Log Collector...
Stopping ISE Monitoring & Troubleshooting Alert Process...
Stopping ISE Monitoring & Troubleshooting Session Database...
Stopping ISE Database processes...
Starting ISE Database processes...
Starting ISE Monitoring & Troubleshooting Session Database...
Starting ISE Application Server...
Starting ISE Monitoring & Troubleshooting Alert Process...
Starting ISE Monitoring & Troubleshooting Log Collector...
Starting ISE Monitoring & Troubleshooting Log Processor...
Note: ISE Processes are initializing. Use 'show application status ise'
      CLI to verify all processes are in running state.
ise/admin#
```

Related Commands

	Description
backup	Performs a backup (Cisco ISE and Cisco ADE OS) and places the backup in a repository.
backup-logs	Backs up system logs.
repository	Enters the repository submode for configuration of backups.
show repository	Displays the available backup files located on a specific repository.
show backup history	Displays the backup history of the system.
show backup status	Displays the status of the backup operation.
show restore status	Displays the status of the restore operation.

If the sync status and replication status after application restore for any secondary node is *Out of Sync*, you have to reimport the certificate of that secondary node to the Primary PAN and perform a manual synchronization.

Related Topics

[Restore Configuration Backups from the GUI](#), on page 289

[Restore History](#), on page 292

[Synchronize Primary and Secondary Nodes in a Distributed Environment](#), on page 292

Restore Configuration Backups from the GUI

You can restore a configuration backup from the Admin portal. The GUI lists only the backups that are taken from the current release. To restore backups that are prior to this release, use the restore command from the CLI.

Before you begin

Ensure that the primary PAN Auto Failover configuration, if enabled in your deployment, is turned off. When you restore a configuration backup, the application server processes are restarted. There might be a delay while these services restart. Due to this delay in restart of services, auto failover of secondary PAN might get initiated.

When your deployment is a dual node deployment at the time configuration backup, ensure the following:

- Source and target nodes for the restore are same as the ones used for the configuration backup, the target node can be either stand-alone or primary.
- Source and target nodes for the restore are different from the ones used in the configuration backup, the target node must be stand-alone.



Note You can restore configuration database backup and regenerate the Root CA on a primary PAN only. However, you cannot restore the configuration database backup on a registered PAN.

-
- Step 1** Choose **Administration** > **System** > **Backup and Restore**.
- Step 2** Select the name of the backup from the list of Configurational backup and click **Restore**.
- Step 3** Enter the Encryption Key used during the backup.
- Step 4** Click **Restore**.
-

What to do next

If you are using the Cisco ISE CA service, you must:

1. Regenerate the entire Cisco ISE CA root chain.
2. Obtain a backup of the Cisco ISE CA certificates and keys from the primary PAN and restore it on the secondary PAN. This ensures that the secondary PAN can function as the root CA or subordinate CA of an external PKI in case of a Primary PAN failure and you promote the secondary PAN to be the primary PAN.

Related Topics

[Restoration of Configuration or Monitoring \(Operational\) Backup from the CLI](#), on page 287

Restoration of Monitoring Database

The process for restoring the Monitoring database is different depending on the type of deployment. The following sections explain how to restore the Monitoring database in standalone and distributed deployments.

You must use the CLI to restore an on-demand Monitoring database backup from previous releases of Cisco ISE. Restoring a scheduled backup across Cisco ISE releases is not supported.



Note If you attempt to restore data to a node other than the one from which the data was taken, you must configure the logging target settings to point to the new node. This ensures that the monitoring syslogs are sent to the correct node.

Related Topics

[Restore a Monitoring \(Operational\) Backup in a Standalone Environment](#), on page 290

[Restore a Monitoring Backup with Administration and Monitor Personas](#), on page 290

[Restore a Monitoring Backup with a Monitoring Persona](#), on page 291

Restore a Monitoring (Operational) Backup in a Standalone Environment

The GUI lists only the backups that are taken from the current release. To restore backups that obtained from earlier releases, use the restore command from the CLI.

Before you begin

- Purge the old monitoring data.
- Schedule a backup or perform an on-demand backup.

-
- Step 1** Choose **Administration** > **System** > **Backup and Restore**.
- Step 2** Select the name of the backup from the list of Operational backup and click **Restore**.
- Step 3** Enter the Encryption Key used during the backup.
- Step 4** Click **Restore**.
-

Related Topics

[Schedule a Backup](#), on page 283

[Perform an On-Demand Backup](#), on page 281

[Restoration of Configuration or Monitoring \(Operational\) Backup from the CLI](#), on page 287

[Restore a Monitoring Backup with Administration and Monitor Personas](#), on page 290

[Restore a Monitoring Backup with a Monitoring Persona](#), on page 291

Restore a Monitoring Backup with Administration and Monitor Personas

You can restore a Monitoring backup in a distributed environment with administration and monitor personas.

Before you begin

- Purge the old monitoring data.

- Schedule a backup or perform an on-demand backup.

-
- Step 1** If you are using a primary and secondary PAN, synchronize the PANs.
When you synchronize the PANs, you must chose a PAN and promote that to be the active primary.
- Step 2** Before you deregister the Monitoring node, assign the Monitoring persona to another node in the deployment.
Every deployment must have at least one functioning Monitoring node.
- Step 3** Deregister the Monitoring node for backup.
- Step 4** Restore the Monitoring backup to the newly deregistered node.
- Step 5** Register the newly restored node with the current Administration node.
- Step 6** Promote the newly restored and registered node as the active Monitoring node.

Related Topics

- [Schedule a Backup](#), on page 283
- [Perform an On-Demand Backup](#), on page 281
- [Synchronize Primary and Secondary Nodes in a Distributed Environment](#), on page 292
- [Restore a Monitoring \(Operational\) Backup in a Standalone Environment](#), on page 290
- [Restore a Monitoring Backup with a Monitoring Persona](#), on page 291

Restore a Monitoring Backup with a Monitoring Persona

You can restore a Monitoring backup in a distributed environment with only Monitoring persona.

Before you begin

- Purge the old monitoring data.
- Schedule a backup or perform an on-demand backup.

-
- Step 1** Prepare to deregister the node to be restored. This is done by assigning the monitoring persona to another node in the deployment.
A deployment must have at least one functioning Monitoring node.
- Step 2** Deregister the node to be restored.
- Note** Wait until the deregistration is complete before proceeding with the restore. The node must be in a standalone state before you can continue with the restore.
- Step 3** Restore the Monitoring backup to the newly deregistered node.
- Step 4** Register the newly restored node with the current Administration node.
- Step 5** Promote the newly restored and registered node as the active Monitoring node.

Related Topics

- [Restore a Monitoring \(Operational\) Backup in a Standalone Environment](#), on page 290

[Restore a Monitoring Backup with Administration and Monitor Personas](#), on page 290

Restore History

You can obtain information about all restore operations, log events, and statuses from the **Operations Audit Report** window.



Note However, the **Operations Audit Report** window does not provide information about the start times corresponding to the previous restore operations.

For troubleshooting information, you have to run the **backup-logs** command from the Cisco ISE CLI and look at the ADE.log file.

While the restore operation is in progress, all Cisco ISE services are stopped. You can use the **show restore status** CLI command to check the progress of the restore operation.

Export Authentication and Authorization Policy Configuration

You can export authentication and authorization policy configuration in the form of an XML file that you can read offline to identify any configuration errors and use for troubleshooting purposes. This XML file includes authentication and authorization policy rules, simple and compound policy conditions, Discretionary Access control Lists (DACLS), and authorization profiles. You can choose to email the XML file or save it to your local system.

Step 1 Choose **Administration > System > Backup & Restore**.

Step 2 Click **Policy Export**.

Step 3 Enter the values as needed.

Step 4 Click **Export**.

Use a text editor such as WordPad to view the contents of the XML file.

Synchronize Primary and Secondary Nodes in a Distributed Environment

In a distributed environment, sometimes the Cisco ISE database in the primary and secondary nodes are not synchronized automatically after restoring a backup file on the PAN. If this happens, you can manually force a full replication from the PAN to the secondary ISE nodes. You can force a synchronization only from the PAN to the secondary nodes. During the sync-up operation, you cannot make any configuration changes. Cisco ISE allows you to navigate to other Cisco ISE Admin portal pages and make any configuration changes only after the synchronization is complete.

Before you begin

To perform the following task, you must be a Super Admin or System Admin.

-
- Step 1** Choose **Administration** > **System** > **Deployment**.
- Step 2** Check the check boxes next to the secondary ISE nodes with an Out of Sync replication status.
- Step 3** Click **Syncup** and wait until the nodes are synchronized with the PAN. You will have to wait until this process is complete before you can access the Cisco ISE Admin portal again.
-

Recovery of Lost Nodes in Standalone and Distributed Deployments

This section provides troubleshooting information that you can use to recover lost nodes in standalone and distributed deployments. Some of the following use cases use the backup and restore functionality and others use the replication feature to recover lost data.

Recovery of Lost Nodes Using Existing IP Addresses and Hostnames in a Distributed Deployment

Scenario

In a distributed deployment, a natural disaster leads to a loss of all the nodes. After recovery, you want to use the existing IP addresses and hostnames.

For example, you have two nodes: N1 (Primary Policy Administration Node or Primary PAN) and N2 (Secondary Policy Administration Node or Secondary PAN.) A backup of the N1 node, which was taken at time T1, is available. Later, both N1 and N2 nodes fail because of a natural disaster.

Assumption

All Cisco ISE nodes in the deployment were destroyed. The new hardware was imaged using the same hostnames and IP addresses.

Resolution Steps

1. You have to replace both the N1 and N2 nodes. N1 and N2 nodes will now have a standalone configuration.
2. Obtain a license with the UDI of the N1 and N2 nodes and install it on the N1 node.
3. You must then restore the backup on the replaced N1 node. The restore script will try to sync the data on N2, but N2 is now a standalone node and the synchronization fails. Data on N1 will be reset to time T1.
4. You must log in to the N1 Admin portal to delete and reregister the N2 node. Both the N1 and N2 nodes will have data reset to time T1.

Related Topics

[Restoration of Configuration or Monitoring \(Operational\) Backup from the CLI](#), on page 287

Recovery of Lost Nodes Using New IP Addresses and Hostnames in a Distributed Deployment

Scenario

In a distributed deployment, a natural disaster leads to loss of all the nodes. The new hardware is reimaged at a new location and requires new IP addresses and hostnames.

For example, you have two ISE nodes: N1 (primary Policy Administration Node or primary PAN) and N2 (secondary Policy Service Node.) A backup of the N1 node which was taken at time T1, is available. Later, both N1 and N2 nodes fail because of a natural disaster. The Cisco ISE nodes are replaced at a new location and the new hostnames are N1A (primary PAN) and N2A (secondary Policy Service Node). N1A and N2A are standalone nodes at this point in time.

Assumptions

All Cisco ISE nodes in the deployment were destroyed. The new hardware was imaged at a different location using different hostnames and IP addresses.

Resolution Steps

1. Obtain the N1 backup and restore it on N1A. The restore script will identify the hostname change and domain name change, and will update the hostname and domain name in the deployment configuration based on the current hostname.
2. You must generate a new self-signed certificate.
3. You must log in to the Cisco ISE administrator portal on N1A, choose **Administration > System > Deployment**, and do the following:

Delete the old N2 node.

Register the new N2A node as a secondary node. Data from the N1A node will be replicated to the N2A node.

Related Topics

[Restoration of Configuration or Monitoring \(Operational\) Backup from the CLI](#), on page 287

Recovery of a Node Using Existing IP Address and Hostname in a Standalone Deployment

Scenario

A standalone administration node is down.

For example, you have a standalone administration node, N1. A backup of the N1 database was taken at time T1. The N1 node goes down because of a physical failure and must be reimaged or a new hardware is required. The N1 node must be brought back up with the same IP address and hostname.

Assumptions

This deployment is a standalone deployment and the new or reimaged hardware has the same IP address and hostname.

Resolution Steps

Once the N1 node is up after a reimage or you have introduced a new Cisco ISE node with the same IP address and hostname, you must restore the backup taken from the old N1 node. You do not have to make any role changes.

Related Topics

[Restoration of Configuration or Monitoring \(Operational\) Backup from the CLI](#), on page 287

Recovery of a Node Using New IP Address and Hostname in a Standalone Deployment

Scenario

A standalone administration node is down.

For example, you have a standalone administration node, N1. A backup of the N1 database taken at time T1 is available. The N1 node is down because of a physical failure and will be replaced by a new hardware at a different location with a different IP address and hostname.

Assumptions

This is a standalone deployment and the replaced hardware has a different IP address and hostname.

Resolution Steps

1. Replace the N1 node with a new hardware. This node will be in a standalone state and the hostname is N1B.
2. You can restore the backup on the N1B node. No role changes are required.

Related Topics

[Restoration of Configuration or Monitoring \(Operational\) Backup from the CLI](#), on page 287

Configuration Rollback

Problem

There may be instances where you inadvertently make configuration changes that you later determine were incorrect. For example, you may delete several NADs or modify some RADIUS attributes incorrectly and realize this issue several hours later. In this case, you can revert to the original configuration by restoring a backup that was taken before you made the changes.

Possible Causes

There are two nodes: N1 (primary Policy Administration Node or primary PAN) and N2 (secondary Policy Administration Node or secondary PAN) and a backup of the N1 node is available. You made some incorrect configuration changes on N1 and want to remove the changes.

Solution

Obtain a backup of the N1 node that was taken before the incorrect configuration changes were made. Restore this backup on the N1 node. The restore script will synchronize the data from N1 to N2.

Related Topics

[Restoration of Configuration or Monitoring \(Operational\) Backup from the CLI](#), on page 287

Recovery of Primary Node in Case of Failure in a Distributed Deployment

Scenario

In a multinode deployment, the PAN fails.

For example, you have two Cisco ISE nodes, N1 (PAN) and N2 (Secondary Administration Node). N1 fails because of hardware issues.

Assumptions

Only the primary node in a distributed deployment has failed.

Resolution Steps

1. Log in to the N2 administrator portal. Choose **Administration** > **System** > **Deployment** and configure N2 as your primary node.

The N1 node is replaced with a new hardware, reimaged, and is in the standalone state.

2. From the N2 administrator portal, register the new N1 node as a secondary node.

Now, the N2 node becomes your primary node and the N1 node becomes your secondary node.

If you wish to make the N1 node the primary node again, log in to the N1 administrator portal and make it the primary node. N2 automatically becomes a secondary server. There is no data loss.

Recovery of Secondary Node in Case of Failure in a Distributed Deployment

Scenario

In a multinode deployment, a single secondary node has failed. No restore is required.

For example, you have multiple nodes: N1 (primary PAN), N2 (secondary PAN), N3 (secondary Policy Service Node), N4 (secondary Policy Service Node). One of the secondary nodes, N3, fails.

Resolution Steps

1. Reimage the new N3A node to the default standalone state.

2. Log in to the N1 Admin portal and delete the N3 node.
3. Reregister the N3A node.
Data is replicated from N1 to N3A. No restore is required.



CHAPTER 14

Setup Adaptive Network Control

- [Enable Adaptive Network Control in Cisco ISE, on page 299](#)
- [Configure Network Access Settings, on page 299](#)
- [Adaptive Network Control, on page 301](#)
- [ANC Quarantine and Unquarantine Flow, on page 303](#)
- [ANC NAS Port Shutdown Flow, on page 304](#)
- [Endpoints Purge Settings, on page 305](#)

Enable Adaptive Network Control in Cisco ISE

ANC is disabled by default. ANC gets enabled only when pxGrid is enabled, and it remains enabled until you manually disable the service in the Admin portal.

Related Topics

[Configure Network Access Settings, on page 299](#)

Configure Network Access Settings

ANC allows you to reset the network access status of an endpoint to quarantine, unquarantine, or shut down a port. These define the degree of authorization for the endpoints in the network.

You can quarantine or unquarantine endpoints, or shut down the network access server (NAS) ports to which endpoints are connected, by using their endpoint IP addresses or MAC addresses. You can perform quarantine and unquarantine operations on the same endpoint multiple times, provided they are not performed simultaneously. If you discover a hostile endpoint on your network, you can shut down the endpoint's access, using ANC to close the NAS port.

To assign an ANC policy to an endpoint:

Before you begin

- Enable ANC.
- Create authorization profiles and exception type authorization policies for ANC.

Step 1 Choose **Operations > Adaptive Network Control > Policy List**.

Step 2 Click **Add**.

Step 3 Enter a name for the ANC policy and specify the ANC action. The following options are available:

- Quarantine
- Shut_Down
- Port_Bounce

You can select one or multiple actions, but you cannot combine Shut_Down and Port_Bounce with the other ANC actions

Step 4 Choose **Policy > Authorization** and associate the ANC policy with the corresponding Authorization policy by using the ANCPolicy attribute.

Step 5 Choose **Operations > Adaptive Network Control > Endpoint Assignment**.

Step 6 Click **Add**.

Step 7 Enter the IP address or MAC address of the endpoint and select the policy from the **Policy Assignment** drop-down list.

Step 8 Click **Submit**.

Related Topics

[Quarantined Endpoints Do Not Renew Authentication Following Policy Change](#), on page 300

Quarantined Endpoints Do Not Renew Authentication Following Policy Change

Problem

Authentication has failed following a change in policy or additional identity and no reauthentication is taking place. Authentication fails or the endpoint in question remains unable to connect to the network. This issue often occurs on client machines that fails posture assessment per the posture policy that is assigned to the user role.

Possible Causes

The authentication timer setting is not correctly set on the client machine, or the authentication interval is not correctly set on the switch.

Solution

There are several possible resolutions for this issue:

1. Check the **Session Status Summary** report in Cisco ISE for the specified NAD or switch, and ensure that the interface has the appropriate authentication interval configured.
2. Enter “show running configuration” on the NAD/switch and ensure that the interface is configured with an appropriate “authentication timer restart” setting. (For example, “authentication timer restart 15,” and “authentication timer reauthenticate 15.”)
3. Enter “interface shutdown” and “no shutdown” to bounce the port on the NAD/switch and force reauthentication following a potential configuration change in Cisco ISE.



Note Because CoA requires a MAC address or session ID, we recommend that you do not bounce the port that is shown in the Network Device SNMP report.

Adaptive Network Control

Adaptive Network Control (ANC) is a service that runs on the Administration node. This service monitors and controls network access of endpoints. ANC is invoked by the ISE administrator on the admin GUI, and also can be invoked through pxGrid from third-party systems. ANC supports wired and wireless deployments and requires a Plus License.

You can use ANC to change the authorization state without having to modify the overall authorization policy of the system. ANC allows you to set the authorization state when you quarantine an endpoint. As a result, the established authorization policies where authorization policies are defined to check for ANCPolicy to limit or deny network access. You can unquarantine an endpoint for full network access. You can also shut down the port on the network attached system (NAS) that disconnects the endpoint from the network.

There are no limits to the number of users that can be quarantined at one time. Also, there are no time constraints on the quarantine period length.

You can perform the following operations to monitor and control network access through ANC:

- **Quarantine:** Allows you to use Exception policies (authorization policies) to limit or deny an endpoint access to the network. You must create Exception policies to assign different authorization profiles (permissions) depending on the ANCPolicy. Setting to the Quarantine state essentially moves an endpoint from its default VLAN to a specified Quarantine VLAN. You must define the Quarantine VLAN previously that is supported on the same NAS as the endpoint.
- **Unquarantine:** Allows you to reverse the quarantine status that permits full access to the network for an endpoint. This happens by returning the endpoint to its original VLAN.
- **Shutdown:** Allows you to deactivate a port on the NAS and disconnect the endpoint from the network. Once the port is shut down on the NAS to which an endpoint is connected, manually reset the port on the NAS again. This allows an endpoint to connect to the network, which is not available for wireless deployments.

Quarantine and unquarantine operations can be triggered from the session directory reports for active endpoints.



Note If a quarantined session is unquarantined, the initiation method for a newly unquarantined session depends on the authentication method that is specified by the switch configuration.



Note As of Cisco ISE 1.4, ANC replaces Endpoint Protection Services (EPS). ANC provides additional classifications, and performance improvements. While using ERS attributes in a policy might still work for some ANC actions some of the time, use ANC attributes.

Related Topics

- [Create Authorization Profiles for Network Access through ANC](#), on page 302
- [ANC Operations Fail when IP Address or MAC Address is not Found](#), on page 303
- [Externally Authenticated Administrators Cannot Perform ANC Operations](#), on page 303
- [Create Exception Policies for Network Access through ANC](#), on page 302

Create Authorization Profiles for Network Access through ANC

You need to create an authorization profile that should be use with ANC. you can view the authorization profile in the list of Standard Authorization Profiles. An endpoint can be authenticated and authorized in the network, but restricted to access network.

-
- Step 1** Choose **Policy > Policy Elements > Authorization > Authorization Profiles**.
 - Step 2** Click **Add**.
 - Step 3** Enter a unique name and description for the authorization profile, and update the **Access Type** as **ACCESS_ACCEPT**.
 - Step 4** Check the **DACL Name** check box, and choose **DENY_ALL_TRAFFIC** from the drop-down list.
 - Step 5** Click **Submit**.
-

Create Exception Policies for Network Access through ANC

For ANC authorization, you should create a quarantine exception policy that is processed before all standard authorization policies. Exception authorization polices are intended for authorizing limited access to meet special conditions or permissions or an immediate requirement. Standard authorization policies are intended to be stable and apply to a large groups of users, devices, and groups that share a common set of privileges.

Before you begin

Created standard authorization profiles to use with ANC.

-
- Step 1** Choose **Policy > Authorization**, and expand **Exceptions**.
 - Step 2** Choose **Enabled** or **Disabled** or **Monitor Only option**.
 - Step 3** Click **Create a New Rule**.
 - Step 4** Enter the exception rule name.
 - Step 5** Click the plus [+] sign to choose an identity group.
 - Step 6** Click the plus [+] sign to choose **Create New Condition (Advanced Option)**.
 - Step 7** Click the down arrow icon in the first field to display the dictionaries list and choose **Session > EPSStatus**.
 - Step 8** Choose **Equals** from the drop-down list in the second field.
 - Step 9** Choose **Quarantine** from the drop-down list in the third field.
 - Step 10** Click **Save**.
-

ANC Operations Fail when IP Address or MAC Address is not Found

An ANC operation that you perform on an endpoint fails when an active session for that endpoint does not contain information about the IP address. This also applies to the MAC address and session ID for that endpoint.



Note When you want to change the authorization state of an endpoint through ANC, you must provide the IP address or the MAC address for the endpoint. If the IP address or the MAC address is not found in the active session for the endpoint, then you will see the following error message:

```
No active session found for this MAC address, IP Address or Session ID
```

Externally Authenticated Administrators Cannot Perform ANC Operations

If an externally authenticated administrator tries to issue CoA-Quarantine from a live session, Cisco ISE returns the following error message:

```
CoA Action of Quarantine for xx:xx:xx:xx:xx:xx can not be initiated. (Cause:User not found internally. Possible use of unsupported externally authenticated user
```

If an externally authenticated administrator performs an ANC operation from **Operations** in the Cisco ISE using the IP address or MAC address of the endpoint, Cisco ISE returns the following error message:

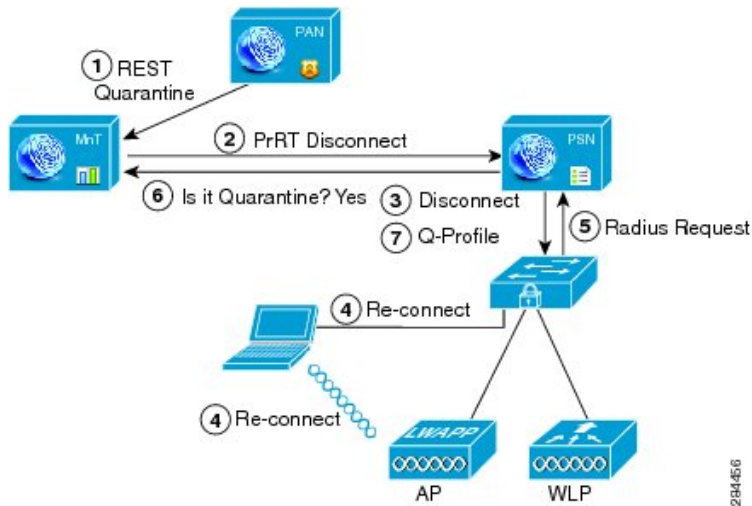
```
Server failure: User not found internally. Possible use of unsupported externally authenticated user
```

ANC Quarantine and Unquarantine Flow

You can quarantine-selected endpoints with ANC, to limit their access to the network. You can quarantine endpoints and establish exception authorization policies that assign different authorization profiles, depending on the status. An authorization profile acts as a container for permissions that you define in the authorization policies that allow access to specified network services. When the authorization is complete, the permissions are granted for a network access request. If the endpoint is then validated, you can unquarantine the endpoint for full access to the network.

This figure illustrates the quarantine flow, which assumes that authorization rules have been configured and the ANC session has been established.

Figure 25: ANC Quarantine Flow



1. A client device logs on to the network through a wireless device (WLC), and a quarantine REST API call is issued from the Administration node (PAP) to the Monitoring node (MnT).
2. The Monitoring node then calls PrRT through the policy services Cisco ISE node (PDP) to invoke a Certificate of Authorization (CoA).
3. The client device is disconnected.
4. The client device then reauthenticates and reconnects.
5. A RADIUS request for the client device is sent back to the Monitoring node.
6. The client device is quarantined while the check is in progress.
7. The Q-Profile authorization policy is applied, and the client device is validated.
8. The client device is unquarantined, and provided with full access to the network.

ANC NAS Port Shutdown Flow

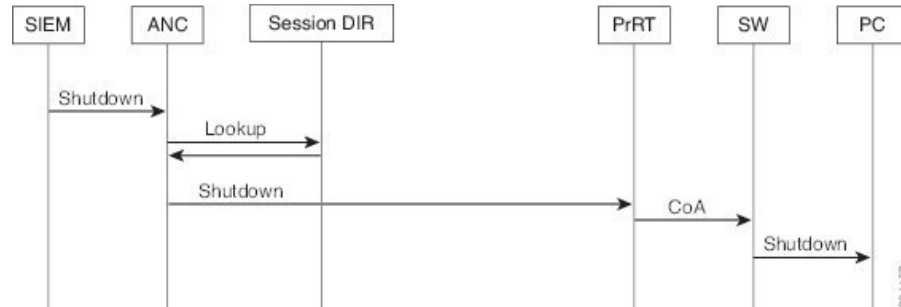
You can shut down the NAS port to which an endpoint is connected by using the endpoint IP address or MAC address.

Shutdown allows you to close a NAS port based on a specified IP address for a MAC address. You have to manually reinstate the port to bring the endpoint back into the network, which is effective only for endpoints that are connected through wired media.

Shutdown may not be supported on all devices. Most switches should support the shutdown command, however. You can use the `getResult()` command to verify that the shutdown is executed successfully.

This figure illustrates the ANC shutdown flow. For the client device, the shutdown operation is performed on the NAS that the client device uses to access the network.

Figure 26: ANC Shutdown Flow



Endpoints Purge Settings

You can define the endpoint purge policy by configuring the rules, based on identity groups and other conditions. Choose **Administration > Identity Management > Settings > Endpoint Purge**. You can choose not to purge specified endpoints and to purge endpoints based on selected profiling conditions.

You can schedule an endpoint purge job. This endpoint purge schedule is enabled by default. Cisco ISE, by default, deletes endpoints and registered devices that are older than 30 days. The purge job runs at 1:00 a.m. (midnight) every day based on the time zone configured in the primary PAN.

Endpoint purge deletes over five thousand endpoints every 3 minutes.

The following are some of the conditions with examples you can use for purging the endpoints:

- **InactivityDays**— Number of days since last profiling activity or update on endpoint
 - This condition purges stale devices that have accumulated over time, commonly transient guest or personal devices, or retired devices. These endpoints tend to represent noise in your deployment as they are no longer active on network or not likely to be seen in near future. If they do happen to connect again, then they will be rediscovered, profiled, registered, etc as needed.
 - When there are updates from endpoint, InactivityDays will be reset to 0 only if profiling is enabled.
- **ElapsedDays**—Numbers days since object is created.
 - This condition can be used for endpoints that have been granted unauthenticated or conditional access for a set time period, such as a guest or contractor endpoint, or employees leveraging webauth for network access. After the allowed connect grace period, they must be fully reauthenticated and registered.
- **PurgeDate**—Date to purge the endpoint.
 - This option can be used for special events or groups where access is granted for a specific time, regardless of creation or start time. This allows all endpoints to be purged at same time. For example, a trade show, a conference, or a weekly training class with new members each week, where access is granted for specific week or month rather than absolute day, week, or month.



PART **IV**

Manage Users and End-User Portals

- [Manage Users and External Identity Sources, on page 309](#)
- [Configure Guest Access, on page 441](#)
- [Support Device Access, on page 483](#)
- [Customize End-User Web Portals, on page 509](#)



CHAPTER 15

Manage Users and External Identity Sources

- [Cisco ISE Users](#), on page 309
- [Internal and External Identity Sources](#), on page 319
- [Certificate Authentication Profiles](#), on page 322
- [Active Directory as an External Identity Source](#), on page 323
- [Active Directory Requirements to Support Easy Connect and Passive Identity services](#), on page 347
- [Easy Connect](#), on page 357
- [PassiveID Work Center](#), on page 361
- [LDAP](#), on page 409
- [ODBC Identity Source](#), on page 417
- [RADIUS Token Identity Sources](#), on page 423
- [RSA Identity Sources](#), on page 428
- [SAMLv2 Identity Provider as an External Identity Source](#), on page 432
- [Identity Source Sequences](#), on page 437
- [Identity Source Details in Reports](#), on page 438

Cisco ISE Users

In this chapter, the term user refers to employees and contractors who access the network regularly as well as sponsor and guest users. A sponsor user is an employee or contractor of the organization who creates and manages guest user accounts through the sponsor portal. A guest user is an external visitor who needs access to the organization's network resources for a limited period of time.

You must create an account for any user to gain access to resources and services on the Cisco ISE network. Employees, contractors, and sponsor users are created from the Admin portal.

From Cisco ISE Release 3.2, you can choose to add the **Date Enabled** column (**Settings > Columns > Date Enabled**) and the **Days Until Password Expires** column (**Settings > Columns > Days Until Password Expires**) to the **Network Access User** table in the **Network Access Users** window (**Administration > Identity Management > Identities > Users**) to help you sort through network access users by using their password expiry information. These fields are not added by default. You can add them to the table using the customization option in the window.

User Identity

User identity is like a container that holds information about a user and forms their network access credentials. Each user's identity is defined by data and includes: a username, e-mail address, password, account description, associated administrative group, user group, and role.

User Groups

User groups are a collection of individual users who share a common set of privileges that allow them to access a specific set of Cisco ISE services and functions.

User Identity Groups

A user's group identity is composed of elements that identify and describe a specific group of users that belong to the same group. A group name is a description of the functional role that the members of this group have. A group is a listing of the users that belong to this group.

Default User Identity Groups

Cisco ISE comes with the following predefined user identity groups:

- Employee—Employees of your organization belong to this group.
- SponsorAllAccount—Sponsor users who can suspend or reinstate all guest accounts in the Cisco ISE network.
- SponsorGroupAccounts—Sponsor users who can suspend guest accounts created by sponsor users from the same sponsor user group.
- SponsorOwnAccounts—Sponsor users who can only suspend the guest accounts that they have created.
- Guest—A visitor who needs temporary access to resources in the network.
- ActivatedGuest—A guest user whose account is enabled and active.

User Role

A user role is a set of permissions that determine what tasks a user can perform and what services they can access on the Cisco ISE network. A user role is associated with a user group. For example, a network access user.

User Account Custom Attributes

Cisco ISE allows you to restrict network access based on user attributes for both network access users and administrators. Cisco ISE comes with a set of predefined user attributes and also allows you to create custom attributes. Both types of attributes can be used in conditions that define the authentication policy. You can also define a password policy for user accounts so that passwords meet specified criteria.

Custom User Attributes

You can configure more user-account attributes on the **User Custom Attributes** window (**Administration > Identity Management > Settings > User Custom Attributes**). You can also view the list of predefined user attributes in this window. You cannot edit the predefined user attributes.

Enter the required details in the **User Custom Attributes** pane to add a new custom attribute. The custom attributes and the default values that you add on the **User Custom Attributes** window are displayed while adding or editing a Network Access user (**Administration > Identity Management > Identities > Users > Add/Edit**) or Admin user (**Administration > System > Admin Access > Administrators > Admin Users > Add/Edit**). You can change the default values while adding or editing a Network Access or Admin user.

You can select the following data types for the custom attributes on the **User Custom Attributes** window:

- String: You can specify the maximum string length (maximum allowed length for a string attribute value).
- Integer: You can configure the minimum and maximum value (specifies the lowest and the highest acceptable integer value).
- Enum: You can specify the following values for each parameter:
 - Internal value
 - Display value

You can also specify the default parameter. The values that you add in the Display field are displayed while adding or editing a Network Access or Admin user.

- Float
- Password: You can specify the maximum string length.
- Long: You can configure the minimum and maximum value.
- IP: You can specify a default IPv4 or IPv6 address.
- Boolean: You can set either True or False as the default value.
- Date: You can select a date from the calendar and set it as the default value. The date is displayed in yyyy-mm-dd format.

Check the **Mandatory** check box if you want to make an attribute mandatory while adding or editing a Network Access or Admin user. You can also set default values for the custom attributes.

The custom attributes can be used in the authentication policies. The data type and the allowable range that you set for the custom attributes are applied to the custom attribute values in the policy conditions.

User Authentication Settings

Not all external identity stores allow network access users to change their passwords. See the section for each identity source for more information.

Network-use password rules should be configured in **Administration > Identity Management > Settings > User Authentication Settings**.

The following section has additional information about some of the fields in the **Password Policy** tab.

- **Required Characters:** If you configure a user-password policy that requires upper or lowercase characters, and the user's language does not support these characters, the user cannot set a password. To support UTF-8 characters, uncheck the following check boxes:

- **Lowercase Alphabetic Characters**

- **Uppercase Alphabetic Characters**

- **Password Change Delta:** Specifies the minimum number of characters that must change when changing the current password to a new password. Cisco ISE does not consider changing the position of a character as a change. For Example, if the password delta is 3, and the current password is "?Aa1234?", then "?Aa1567?" ("5", "6" and "7" are the three new characters) is a valid new password. "?Aa1562?" fails, because "?", "2", and "?" characters are in the current password. "Aa1234??" fails, because even though the character positions changed, the same characters are in the current password.

Password change delta also considers the previous X passwords, where X is the value of **Password must be different from the previous versions**. If your password delta is 3, and your password history is 2, then you must change the four characters that are not a part of the past two passwords.

- **Dictionary words:** Check this check box to restrict the use of any dictionary word, its characters in reverse order, or its letters replaced with other characters.

Substitution of "\$" for "s", "@" for "a", "0" for "o", "1" for "l", "!" for "i", "3" for "e", is not permitted. For example, "Pa\$\$w0rd".

- **Default Dictionary:** Choose this option to use the default Linux dictionary in Cisco ISE. The default dictionary contains approximately 480,000 English words.

- **Custom Dictionary:** Choose this option to use your customized dictionary. Click **Choose File** to select a custom dictionary file. The text file must be of newline-delimited words, .dic extension, and size less than 20 MB.

- You can use the **Password Lifetime** section to update the password reset interval and reminder. To set the lifetime of a password, check the **Change password every __ days (valid range 1 to 3650)** check box, and enter the number of days in the input field. A user account can be disabled if a user does not change the password in the specified time by selecting the **Disable User Account** option. Choose the **Require password change on next login** to prompt the user to change their password the next time they login to Cisco ISE.

To send a reminder email for password reset, check the **Display Reminder __ Days Prior to Password Expiration** check box and enter the number of days before which a reminder email should be sent to the email address configured for the network access user. While creating a network access user, you can add the email address in the **Administration > Identity Management > Identities > Users > Add Network Access User** window to send an email notification for password reset.

**Note**

- The reminder email is sent from the following email address: `iseadminportal@<ISE-Primary-FQDN>`. You must explicitly permit access for this sender.
- By default, the reminder email has the following content: Your network access password will expire on `<password expiry date and time>`. Please contact your system administrator for assistance.

From Cisco ISE Release 3.2, you can customize the email content after the *Please contact your system administrator for assistance* portion of the email notification.

- **Lock/Suspend Account with Incorrect Login Attempts:** Use this option to suspend or lock an account if the login attempt failed for the specified number of times. The valid range is from 3 to 20.
- **Account Disable Policy:** Configure the rules about when to disable an existing user account. See [Disable User Accounts Globally](#) for more information.

Related Topics

[User Account Custom Attributes](#), on page 310

[To Add Users](#), on page 313

Generate Automatic Password for Users and Administrators

You can use the **Generate Password** option on the user and administrator creation window to generate instant password adhering to Cisco ISE password policies. This helps the users or administrators to use the password generated by Cisco ISE than spending time in thinking of a safe password to be configured.

The **Generate Password** option is available in the following windows:

- **Administration > Identity Management > Identities > Users.**
- **Administration > System > Admin Access > Administrators > Admin Users.**
- **Settings > Account Settings > Change Password.**

To Add Users

Cisco ISE allows you to view, create, modify, duplicate, delete, change the status, import, export, or search for attributes of Cisco ISE users.

If you are using a Cisco ISE internal database, you must create an account for any new user who needs access to the resources or services on a Cisco ISE network.

Step 1 Choose **Administration > Identity Management > Identities > Users**.

You can also create users by accessing the **Work Centers > Device Administration > Identities > Users** window.

Step 2 Click **Add (+)** to create a new user.

Step 3 Enter values in all the fields the fields.

Note Do not include space, +, and * characters in the username.

Step 4 Click **Submit** to create a new user in the Cisco ISE internal database.

Export Cisco ISE User Data

You might have to export user data from the Cisco ISE internal database. Cisco ISE allows you to export user data in the form of a password-protected csv file.

- Step 1** Choose **Administration > Identity Management > Identities > Users**.
 - Step 2** Check the check box that corresponds to the user(s) whose data you want to export.
 - Step 3** Click **Export Selected**.
 - Step 4** Enter a key for encrypting the password in the Key field.
 - Step 5** Click **Start Export** to create a users.csv file.
 - Step 6** Click **OK** to export the users.csv file.
-

Import Cisco ISE Internal Users

You can import new user data into Cisco ISE with a CSV file to create new internal accounts. A template CSV file is available for download while you import user accounts. Sponsors can import users on the Sponsor portal. See [Configure Account Content for Sponsor Account Creation, on page 469](#) for information about configuring the information types that the sponsor guest accounts use.



Note If the CSV file contains custom attributes, the data type and the allowable range that you set for the custom attributes will be applied for the custom attribute values during import.

- Step 1** Choose **Administration > Identity Management > Identities > Users**.
 - Step 2** Click **Import** to import users from a comma-delimited text file.
If you do not have a comma-delimited text file, click **Generate a Template** to create a CSV file with the heading rows filled in.
 - Step 3** In the File text box, enter the filename containing the users to import, or click **Browse** and navigate to the location where the file resides.
 - Step 4** Check the **Create new user(s) and update existing user(s) with new data** check box if you want to create new users and update existing users.
 - Step 5** Click **Save**.
-



Note We recommend that you do not delete all the network access users at a time, because this may lead to CPU spike and the services to crash, especially if you are using a very large database.

Create a User Identity Group

You must create a user identity group before you can assign a user to it.

-
- Step 1** Choose **Administration > Identity Management > Groups > Identity Groups > User Identity Groups > Add**.
You can also create a user identity group by accessing the **Work Centers > Device Administration > User Identity Groups > Identity Groups > User Identity Groups > Add** page.
- Step 2** Enter values in the Name and Description fields. Supported characters for the Name field are space # \$ & ' () * + - . / @ _ .
- Step 3** Click **Submit**.
-

Related Topics

[User Identity Groups](#), on page 310

Export User Identity Groups

Cisco ISE allows you to export locally configured user identity groups in the form of a csv file.

-
- Step 1** Choose **Administration > Identity Management > Groups > Identity Groups > User Identity Groups**.
- Step 2** Check the check box that corresponds to the user identity group that you want to export, and click **Export**.
- Step 3** Click **OK**.
-

Import User Identity Groups

Cisco ISE allows you to import user identity groups in the form of a csv file.

-
- Step 1** Choose **Administration > Identity Management > Groups > Identity Groups > User Identity Groups**.
- Step 2** Click **Generate a Template** to get a template to use for the import file.
- Step 3** Click **Import** to import network access users from a comma-delimited text file.
- Step 4** Check the **Overwrite existing data with new data** check box if you want to both add a new user identity group and update existing user identity groups.
- Step 5** Click **Import**.
- Step 6** Click **Save** to save your changes to the Cisco ISE database.
-

Create Authorization Policy Using External Identity Sources

Following are the steps for creating an authorization policy using external identity sources:

-
- Step 1** Choose **Policy > Authorization** to create a new authorization policy rule under Standard policies.
- If you enabled Policy Sets, choose **Policy > Policy Set**, pick the Policy Set you plan to use for this portal, expand Authorization Policy, and add a new rule.
- Step 2** For **Conditions**, select an endpoint identity group that you want to use for the portal validation.
- When the external identity source (for example, RSA SecurID) is used with the internal user group, you should create the condition using the following syntax:
- ```
InternalUser:IdentityGroup EQUALS User Identity Groups:Group_Name
```
- Prefix the group name with "User Identity Groups:" without the quotes.
- Step 3** For **Permissions**, select the portal authorization profile that you created.
- 

## Configure Maximum Concurrent Sessions

For optimal performance, you can limit the number of concurrent user sessions. You can set the limits at the user level or at the group level. Depending upon the maximum user session configurations, the session count is applied to the user.

You can configure the maximum number of concurrent sessions for each user per ISE node. Sessions above this limit are rejected.

- 
- Step 1** Choose **Administration > System > Settings > Max Sessions > User**.
- Step 2** Do one of the following:
- Enter the maximum number of concurrent sessions that are allowed for each user in the **Maximum Sessions per User** field.
  - Check the **Unlimited Sessions** check box if you want the users to have unlimited sessions. This option is selected by default.
- Step 3** Click **Save**.
- 

If the maximum number of sessions is configured at both the user and group level, the smaller value will have precedence. For example, if the maximum session value for a user is set as 10 and the maximum session value of the group to which the user belongs is set as 5, the user can have a maximum of 5 sessions only.





**Note** The maximum concurrent session count is managed by the PSN in which it is configured. This count is not synchronized among the PSNs. If the authentication is done in Cisco ISE, where the maximum concurrent sessions per user or group is configured, and authorization is done in a different proxy server, then the maximum concurrent session limit is applicable only in the Cisco ISE and is not applied to the proxy server.

Maximum concurrent session count is implemented in the runtime process and the data is stored only in the memory. If the PSN is restarted, the maximum concurrent session counters are reset.

Maximum concurrent session count is case insensitive with respect to usernames irrespective of the Network Access Device used (when the same PSN node is used)

### Maximum Concurrent Sessions for a Group

You can configure the maximum number of concurrent sessions for the identity groups.

Sometimes all the sessions can be used by a few users in the group. Requests from other users to create a new session are rejected because the number of sessions has already reached the maximum configured value. Cisco ISE allows you to configure a maximum session limit for each user in the group; each user belonging to a specific identity group cannot open sessions more than the session limit, irrespective of the number of sessions other users from the same group have opened. When calculating the session limit for a particular user, the lowest configuration value takes the precedence—whether the global session limit per user, the session limit per identity group that the user belongs to, or the session limit per user in the group.

To configure maximum number of concurrent sessions for an identity group:

---

**Step 1** Choose **Administration > System > Settings > Max Sessions > Group**.

All the configured identity groups are listed.

**Step 2** Click the Edit icon next to the group that you want to edit and enter the values for the following:

- Maximum number of concurrent sessions permitted for that group. If the maximum number of sessions for a group is set as 100, the total count of all sessions established by all members of that group cannot exceed 100.

**Note** Group-level session limits are applied based on the group hierarchy.

- Maximum number of concurrent sessions permitted for each user in that group. This option overrides the maximum number of sessions for a group.

If you want to set the maximum number of concurrent sessions for a group or maximum concurrent sessions for the users in a group as Unlimited, leave the **Max Sessions for Group/Max Sessions for User in Group** field blank, click the Tick icon, and then click Save. By default, both these values are set as Unlimited.

**Step 3** Click **Save**.

---

### Configure Counter Time Limit

You can configure the timeout value for concurrent user sessions.

---

**Step 1** Choose **Administration > System > Settings > Max Sessions > Counter Time Limit**.

**Step 2** Select one of the following options:

- **Unlimited:** Check this check box if you do not want to set any timeout or time limit for the sessions.
- **Delete sessions after:** You can enter the timeout value for concurrent sessions in minutes, hours, or days. When a session exceeds the time limit, Cisco ISE deletes the session from the counter and updates the session count, thereby allowing new sessions. Users will not be logged out if their sessions exceed the time limit.

**Step 3** Click **Save**.

---

You can reset the session count from the RADIUS Live Logs window. Click the Actions icon displayed on the Identity, Identity Group, or Server column to reset the session count. When you reset a session, the session is deleted from the counter (thereby allowing new sessions). Users will not be disconnected if their sessions are deleted from the counter.

## Disable Individual User Accounts

Cisco ISE allows you to disable the user account for each individual user if the disable account date exceeds the date specified by the admin user.

**Step 1** Choose **Administration > Identity Management > Identities > Users**.

**Step 2** Click **Add** to create a new user or check the check box next to an existing user and click **Edit** to edit the existing user details.

**Step 3** Check the **Disable account if the date exceeds** check box and select the date.

This option allows you to disable the user account when the configured date exceeds at user level. You can configure different expiry dates for different users as required. This option overrules the global configuration for each individual user. The configured date can either be the current system date or a future date.

**Note** You are not allowed to enter a date earlier than the current system date.

**Step 4** Click **Submit** to configure the account disable policy for an individual user.

## Disable User Accounts Globally

You can disable user accounts on a certain date, several days after account creation or last access date, and after several days of account inactivity.

**Step 1** Choose **Administration > Identity Management > Settings > User Authentication Settings > Account Disable Policy**.

**Step 2** Perform one of the following actions:

- Check the **Disable account if date exceeds** check box and select the appropriate date in yyyy-mm-dd format. This option allows you to disable the user account after the configured date. The **Disable account if date exceeds** setting at user level takes precedence over this global configuration.
- Check the **Disable account after n days of account creation or last enable** check box and enter the number of days. This option disables the user account when the account creation date or last access date exceeds the specified

number of days. Administrators can manually enable the disabled user accounts, which reset the number of days count.

- Check the **Disable account after n days of inactivity** check box and enter the number of days. This option disables the user account when the account is inactive for the specified number of days.

**Step 3** Click **Submit** to configure the global account disable policy.

## Internal and External Identity Sources

Identity sources are databases that store user information. Cisco ISE uses user information from the identity source to validate user credentials during authentication. User information includes group information and other attributes that are associated with the user. You can add, edit, and delete user information from identity sources.

Cisco ISE supports internal and external identity sources. You can use both sources to authenticate sponsor and guest users.

### Internal Identity Sources

Cisco ISE has an internal user database where you can store user information. Users in the internal user database are called internal users. Cisco ISE also has an internal endpoint database that stores information about all the devices and endpoints that connect to it.

### External Identity Sources

Cisco ISE allows you to configure the external identity source that contains user information. Cisco ISE connects to an external identity source to obtain user information for authentication. External identity sources also include certificate information for the Cisco ISE server and certificate authentication profiles. Cisco ISE uses authentication protocols to communicate with external identity sources.

The following table lists authentication protocols and the external identity sources that they support.

**Table 16: Authentication Protocols and Supported External Identity Sources**

| Protocol (Authentication Type)     | Internal Database | Active Directory | LDAP | RADIUS Token Server or RSA | ODBC |
|------------------------------------|-------------------|------------------|------|----------------------------|------|
| EAP-GTC, PAP (plain text password) | Yes               | Yes              | Yes  | Yes                        | Yes  |

| Protocol (Authentication Type)                                                                                                                                                                                | Internal Database | Active Directory | LDAP | RADIUS Token Server or RSA | ODBC |
|---------------------------------------------------------------------------------------------------------------------------------------------------------------------------------------------------------------|-------------------|------------------|------|----------------------------|------|
| MS-CHAP password hash:<br>MSCHAPv1/v2<br>EAP-MSCHAPv2 (as inner method of PEAP, EAP-FAST, or EAP-TTLS)<br>LEAP                                                                                                | Yes               | Yes              | No   | No                         | Yes  |
| EAP-MD5<br>CHAP                                                                                                                                                                                               | Yes               | No               | No   | No                         | Yes  |
| EAP-TLS<br>PEAP-TLS (certificate retrieval)<br><b>Note</b> For TLS authentications (EAP-TLS and PEAP-TLS), identity sources are not required but can optionally be added for authorization policy conditions. | No                | Yes              | Yes  | No                         | No   |

Credentials are stored differently, depending on the external data source connection type, and the features used.

- When joining an Active Directory Domain (but not for Passive ID), the credentials that are used to join are not saved. Cisco ISE creates an AD computer account, if it does not exist, and uses that account to authenticate users.
- For LDAP and Passive ID, the credentials that are used to connect to the external data source are also used to authenticate users.

## Create an External Identity Source

Cisco ISE can connect with external identity sources such as Active Directory, LDAP, RADIUS Token, and RSA SecurID servers to obtain user information for authentication and authorization. External identity sources also include certificate authentication profiles that you need for certificate-based authentications.



---

**Note** To work with passive identity services, which enable you to receive and share authenticated user identities, see [Additional Passive Identity Service Providers, on page 369](#).

---

---

**Step 1** Choose **Administration > Identity Management > External Identity Sources**.

**Step 2** Choose one of these options:

- **Certificate Authentication Profile** for certificate-based authentications.
  - **Active Directory** to connect to an Active Directory as an external identity source. See [Active Directory as an External Identity Source, on page 323](#) for more details.
  - **LDAP** to add an LDAP identity source. See [LDAP, on page 409](#) for more details.
  - **RADIUS Token** to add a RADIUS Token server. See [RADIUS Token Identity Sources, on page 423](#) for more details.
  - **RSA SecurID** to add an RSA SecurID server. See [RSA Identity Sources, on page 428](#) for more details.
  - **SAML Id Providers** to add an identity provider (IdP), such as Oracle Access Manager. See [SAMLv2 Identity Provider as an External Identity Source, on page 432](#) for more details.
- 

## Authenticate Internal Users Against External Identity Store Password

Cisco ISE allows you to authenticate internal users against external identity store passwords. Cisco ISE provides an option to select the password identity store for internal users from the **Administration > Identity Management > Identities > Users** window. Administrators can select the identity store from the list of Cisco ISE External Identity Sources while adding or editing users in the **Users** window. The default password identity store for an internal user is the internal identity store. Cisco Secure ACS users will retain the same password identity store during and after migration from Cisco Secure ACS to Cisco ISE.

Cisco ISE supports the following external identity stores for password types:

- Active Directory
- LDAP
- ODBC
- RADIUS Token server
- RSA SecurID server



---

**Note** As per the current design, if authentication is done against an external ID store, then the internal user identity group name cannot be configured in authorization policy. In order to use internal user identity group for authorization, authentication policy must be configured to authenticate against Internal Users ID store and password type, which can be either internal or external, must be selected in user configuration.

---

## Certificate Authentication Profiles

For each profile, you must specify the certificate field that should be used as the principal username and whether you want a binary comparison of the certificates.

### Add a Certificate Authentication Profile

You must create a certificate authentication profile if you want to use the Extensible Authentication Protocol-Transport Layer Security (EAP-TLS) certificate-based authentication method. Instead of authenticating via the traditional username and password method, Cisco ISE compares a certificate received from a client with one in the server to verify the authenticity of a user.

#### Before you begin

You must be a Super Admin or System Admin.

---

#### Step 1

**Step 2** Enter the name and an optional description for the certificate authentication profile.

**Step 3** Select an identity store from the drop-down list.

Basic certificate checking does not require an identity source. If you want binary comparison checking for the certificates, you must select an identity source. If you select Active Directory as an identity source, subject and common name and subject alternative name (all values) can be used to look up a user.

**Step 4** Select the use of identity from **Certificate Attribute** or **Any Subject or Alternative Name Attributes in the Certificate**. This will be used in logs and for lookups.

If you choose **Any Subject or Alternative Name Attributes in the Certificate**, Active Directory UPN will be used as the username for logs and all subject names and alternative names in a certificate will be tried to look up a user. This option is available only if you choose Active Directory as the identity source.

**Step 5** Choose when you want to **Match Client Certificate Against Certificate In Identity Store**. For this you must select an identity source (LDAP or Active Directory.) If you select Active Directory, you can choose to match certificates only to resolve identity ambiguity.

- **Never:** This option never performs a binary comparison.
- **Only to resolve identity ambiguity:** This option performs the binary comparison of client certificate to certificate on account in Active Directory only if ambiguity is encountered. For example, several Active Directory accounts matching to identity names from certificate are found.
- **Always perform binary comparison:** This option always performs the binary comparison of client certificate to certificate on account in identity store (Active Directory or LDAP).

**Step 6** Click **Submit** to add the certificate authentication profile or save the changes.

## Active Directory as an External Identity Source

Cisco ISE uses Microsoft Active Directory as an external identity source to access resources such as users, machines, groups, and attributes. User and machine authentication in Active Directory allows network access only to users and devices that are listed in Active Directory.

### [ISE Community Resource](#)

[ISE Administrative Portal Access with AD Credentials Configuration Example](#)

## Active Directory-Supported Authentication Protocols and Features

Active Directory supports features such as user and machine authentications, changing Active Directory user passwords with some protocols. The following table lists the authentication protocols and the respective features that are supported by Active Directory.

*Table 17: Authentication Protocols Supported by Active Directory*

| Authentication Protocols                                                                                                 | Features                                                                                                                                                                |
|--------------------------------------------------------------------------------------------------------------------------|-------------------------------------------------------------------------------------------------------------------------------------------------------------------------|
| EAP-FAST and password based Protected Extensible Authentication Protocol (PEAP)                                          | User and machine authentication with the ability to change passwords using EAP-FAST and PEAP with an inner method of MS-CHAPv2 and EAP-GTC                              |
| Password Authentication Protocol (PAP)                                                                                   | User and machine authentication                                                                                                                                         |
| Microsoft Challenge Handshake Authentication Protocol Version 1 (MS-CHAPv1)                                              | User and machine authentication                                                                                                                                         |
| Microsoft Challenge Handshake Authentication Protocol Version 2 (MS-CHAPv2)                                              | User and machine authentication                                                                                                                                         |
| Extensible Authentication Protocol-Generic Token Card (EAP-GTC)                                                          | User and machine authentication                                                                                                                                         |
| Extensible Authentication Protocol-Transport Layer Security (EAP-TLS)                                                    | <ul style="list-style-type: none"> <li>• User and machine authentication</li> <li>• Groups and attributes retrieval</li> <li>• Binary certificate comparison</li> </ul> |
| Extensible Authentication Protocol- Flexible Authentication via Secure Tunneling-Transport Layer Security (EAP-FAST-TLS) | <ul style="list-style-type: none"> <li>• User and machine authentication</li> <li>• Groups and attributes retrieval</li> <li>• Binary certificate comparison</li> </ul> |

| Authentication Protocols                                                         | Features                                                                                                                                                                |
|----------------------------------------------------------------------------------|-------------------------------------------------------------------------------------------------------------------------------------------------------------------------|
| Protected Extensible Authentication Protocol-Transport Layer Security (PEAP-TLS) | <ul style="list-style-type: none"> <li>• User and machine authentication</li> <li>• Groups and attributes retrieval</li> <li>• Binary certificate comparison</li> </ul> |
| Lightweight Extensible Authentication Protocol (LEAP)                            | User authentication                                                                                                                                                     |

## Active Directory Attribute and Group Retrieval for Use in Authorization Policies

Cisco ISE retrieves user or machine attributes and groups from Active Directory for use in authorization policy rules. These attributes can be used in Cisco ISE policies and determine the authorization level for a user or machine. Cisco ISE retrieves user and machine Active Directory attributes after successful authentication and can also retrieve attributes for an authorization that is independent of authentication.

Cisco ISE may use groups in external identity stores to assign permissions to users or computers; for example, to map users to sponsor groups. You should note the following restrictions on group memberships in Active Directory:

- Policy rule conditions may reference any of the following: a user's or computer's primary group, the groups of which a user or computer is a direct member, or indirect (nested) groups.
- Domain local groups outside a user's or computer's account domain are not supported.



**Note** You can use the value of the Active Directory attribute, `msRadiusFramedIPAddress`, as an IP address. This IP address can be sent to a network access server (NAS) in an authorization profile. The `msRADIUSFramedIPAddress` attribute supports only IPv4 addresses. Upon user authentication, the `msRadiusFramedIPAddress` attribute value fetched for the user will be converted to IP address format.

Attributes and groups are retrieved and managed per join point. They are used in authorization policy (by selecting first the join point and then the attribute). You cannot define attributes or groups per scope for authorization, but you can use scopes for authentication policy. When you use a scope in authentication policy, it is possible that a user is authenticated via one join point, but attributes and/or groups are retrieved via another join point that has a trust path to the user's account domain. You can use authentication domains to ensure that no two join points in one scope have any overlap in authentication domains.



**Note** During the authorization process in a multi join point configuration, Cisco ISE will search for join points in the order in which they listed in the authorization policy, only until a particular user has been found. Once a user has been found the attributes and groups assigned to the user in the join point, will be used to evaluate the authorization policy.





**Note** See Microsoft-imposed limits on the maximum number of usable Active Directory groups: [http://technet.microsoft.com/en-us/library/active-directory-maximum-limits-scalability\(v=WS.10\).aspx](http://technet.microsoft.com/en-us/library/active-directory-maximum-limits-scalability(v=WS.10).aspx)

An authorization policy fails if the rule contains an Active Directory group name with special characters such as /, !, @, \, #, \$, %, ^, &, \*, (, ), \_, +, or ~.

Admin user login through Active Directory might fail if the admin username contains \$ character.

### Use Explicit UPN

To reduce ambiguity when matching user information against Active Directory's User-Principal-Name (UPN) attributes, you must configure Active Directory to use Explicit UPN. Using Implicit UPN can produce ambiguous results if two users have the same value for *sAMAccountName*.

To set Explicit UPN in Active Directory, open the **Advanced Tuning** page, and set the attribute *REGISTRY.Services\Isass\Parameters\Providers\ActiveDirectory\UseExplicitUPN* to 1.

## Support for Boolean Attributes

Cisco ISE supports retrieving Boolean attributes from Active Directory and LDAP identity stores.

You can configure the Boolean attributes while configuring the directory attributes for Active Directory or LDAP. These attributes are retrieved upon authentication with Active Directory or LDAP.

The Boolean attributes can be used for configuring policy rule conditions.

The Boolean attribute values are fetched from Active Directory or LDAP server as String type. Cisco ISE supports the following values for the Boolean attributes:

| Boolean attribute | Supported values             |
|-------------------|------------------------------|
| True              | t, T, true, TRUE, True, 1    |
| False             | f, F, false, FALSE, False, 0 |



**Note** Attribute substitution is not supported for the Boolean attributes.

If you configure a Boolean attribute (for example, *msTSAllowLogon*) as String type, the Boolean value of the attribute in the Active Directory or LDAP server will be set for the String attribute in Cisco ISE. You can change the attribute type to Boolean or add the attribute manually as Boolean type.

## Active Directory Certificate Retrieval for Certificate-Based Authentication

Cisco ISE supports certificate retrieval for user and machine authentication that uses the EAP-TLS protocol. The user or machine record on Active Directory includes a certificate attribute of the binary data type. This certificate attribute can contain one or more certificates. Cisco ISE identifies this attribute as *userCertificate* and does not allow you to configure any other name for this attribute. Cisco ISE retrieves this certificate and uses it to perform binary comparison.

The certificate authentication profile determines the field where the username is taken from in order to lookup the user in Active Directory to be used for retrieving certificates, for example, Subject Alternative Name (SAN) or Common Name. After Cisco ISE retrieves the certificate, it performs a binary comparison of this certificate with the client certificate. When multiple certificates are received, Cisco ISE compares the certificates to check for one that matches. When a match is found, the user or machine authentication is passed.

## Active Directory User Authentication Process Flow

When authenticating or querying a user, Cisco ISE checks the following:

- MS-CHAP and PAP authentications check if the user is disabled, locked out, expired or out of logon hours and the authentication fails if any of these conditions are true.
- EAP-TLS authentications checks if the user is disabled or locked out and the authentication fails if any of these conditions are met.

## Support for Active Directory Multidomain Forests

Cisco ISE supports Active Directory with multidomain forests. Within each forest, Cisco ISE connects to a single domain, but can access resources from the other domains in the Active Directory forest if trust relationships are established between the domain to which Cisco ISE is connected and the other domains.

Refer to Release Notes for Cisco Identity Services Engine for a list of Windows Server Operating Systems that support Active Directory services.



---

**Note** Cisco ISE does not support Microsoft Active Directory servers that reside behind a network address translator and have a Network Address Translation (NAT) address.

---

## Prerequisites for Integrating Active Directory and Cisco ISE

This section describes the manual steps required to configure Active Directory for integration with Cisco ISE. However, in most cases, you can enable Cisco ISE to automatically configure Active Directory. The following are the prerequisites to integrate Active Directory with Cisco ISE.

- Ensure you have Active Directory Domain Admin credentials, required to make changes to any of the AD domain configurations.
- Ensure you have the privileges of a Super Admin or System Admin in Cisco ISE.
- Use the Network Time Protocol (NTP) server settings to synchronize the time between the Cisco ISE server and Active Directory. You can configure NTP settings from Cisco ISE CLI.
- Cisco ISE can connect with multiple Active Directory domains that do not have a two-way trust or have zero trust between them. If you want to query other domains from a specific join point, ensure that trust relationships exist between the join point and the other domains that have user and machine information to which you need access. If trust relationships does not exist, you must create another join point to the untrusted domain. For more information on establishing trust relationships, refer to Microsoft Active Directory documentation.

- You must have at least one global catalog server operational and accessible by Cisco ISE, in the domain to which you are joining Cisco ISE.

## Active Directory Account Permissions Required to Perform Various Operations

| Join Operations                                                                                                                                                                                                                                                                                                                                                                                                                 | Leave Operations                                                                                                                                                                                                                                                                                                                                                                            | Cisco ISE Machine Accounts                                                                                                                                                                                                                                                                                                                                                                                                                                                                                                                                                                                                                                                                                                                                                          |
|---------------------------------------------------------------------------------------------------------------------------------------------------------------------------------------------------------------------------------------------------------------------------------------------------------------------------------------------------------------------------------------------------------------------------------|---------------------------------------------------------------------------------------------------------------------------------------------------------------------------------------------------------------------------------------------------------------------------------------------------------------------------------------------------------------------------------------------|-------------------------------------------------------------------------------------------------------------------------------------------------------------------------------------------------------------------------------------------------------------------------------------------------------------------------------------------------------------------------------------------------------------------------------------------------------------------------------------------------------------------------------------------------------------------------------------------------------------------------------------------------------------------------------------------------------------------------------------------------------------------------------------|
| <p>The join operation requires the following account permissions:</p> <ul style="list-style-type: none"> <li>• Search Active Directory (to see if a Cisco ISE machine account exists)</li> <li>• Create Cisco ISE machine account to domain (if the machine account does not already exist)</li> <li>• Set attributes on the new machine account (for example, Cisco ISE machine account password, SPN, dnsHostname)</li> </ul> | <p>The leave operation requires the following account permissions:</p> <ul style="list-style-type: none"> <li>• Search Active Directory (to see if a Cisco ISE machine account exists)</li> <li>• Remove the Cisco ISE machine account from the domain</li> </ul> <p>If you perform a force leave (leave without the password), it will not remove the machine account from the domain.</p> | <p>The ISE machine account that communicates to the Active Directory connection requires the following permissions:</p> <ul style="list-style-type: none"> <li>• Change password</li> <li>• Read the user and machine objects corresponding to users and machines that are authenticated</li> <li>• Query Active Directory to get information (for example, trusted domains, alternative UPN suffixes, and so on)</li> <li>• Read the tokenGroups attribute</li> </ul> <p>You can precreate the machine account in Active Directory. If the SAM name matches the Cisco ISE appliance hostname, it is located during the join operation and re-used.</p> <p>If there are multiple join operations, multiple machine accounts are maintained inside Cisco ISE, one for each join.</p> |



**Note** The credentials that are used for the join or leave operation are not stored in Cisco ISE. Only the newly created Cisco ISE machine account credentials are stored.

The **Network access: Restrict clients allowed to make remote calls to SAM** security policy in Microsoft Active Directory has been revised. Hence, Cisco ISE might not be able to update its machine account password every 15 days. If the machine account password is not updated, Cisco ISE will no longer authenticate users through Microsoft Active Directory. You will receive the **AD: ISE password update failed** alarm on your Cisco ISE dashboard to notify you of this event.



**Note** This issue happens in Windows Server 2016 Active Directory or later and Windows 10 version 1607 due to the restriction in them. To overcome this restriction, when you are integrating Windows Server 2016 Active Directory or later or Windows 10 version 1607 with Cisco ISE, you must set the registry value in the following registry from non-zero to blank to give access to all:  
Registry:HKEY\_LOCAL\_MACHINE\SYSTEM\CurrentControlSet\Control\Lsa\restrictremotesam This allows Cisco ISE to update its machine account password.

The security policy allows users to enumerate users and groups in the local Security Accounts Manager (SAM) database and in Microsoft Active Directory. To ensure Cisco ISE can update its machine account password, check that your configurations in Microsoft Active Directory are accurate. For more information on the Windows operating systems and Windows Server versions affected, what this means for your network, and what changes may be needed, see:

<https://docs.microsoft.com/en-us/windows/security/threat-protection/security-policy-settings/network-access-restrict-clients-allowed-to-make-remote-sam-calls>

## Network Ports that Must Be Open for Communication

| Protocol           | Port (remote-local)                          | Target                            | Authenticated                | Notes     |
|--------------------|----------------------------------------------|-----------------------------------|------------------------------|-----------|
| DNS (TCP/UDP)      | Random number greater than or equal to 49152 | DNS Servers/AD Domain Controllers | No                           | —         |
| MSRPC              | 445                                          | Domain Controllers                | Yes                          | —         |
| Kerberos (TCP/UDP) | 88                                           | Domain Controllers                | Yes (Kerberos)               | MS AD/KDC |
| LDAP (TCP/UDP)     | 389                                          | Domain Controllers                | Yes                          | —         |
| LDAP (GC)          | 3268                                         | Global Catalog Servers            | Yes                          | —         |
| NTP                | 123                                          | NTP Servers/Domain Controllers    | No                           | —         |
| IPC                | 80                                           | Other ISE Nodes in the Deployment | Yes (Using RBAC credentials) | —         |

## DNS Server

While configuring your DNS server, make sure that you take care of the following:

- The DNS servers that you configure in Cisco ISE must be able to resolve all forward and reverse DNS queries for the domains that you want to use.
- The Authoritative DNS server is recommended to resolve Active Directory records, as DNS recursion can cause delays and have significant negative impact on performance.

- All DNS servers must be able to answer SRV queries for DCs, GCs, and KDCs with or without additional Site information.
- Cisco recommends that you add the server IP addresses to SRV responses to improve performance.
- Avoid using DNS servers that query the public Internet. They can leak information about your network when an unknown name has to be resolved.

## Configure Active Directory as an External Identity Source

Configure Active Directory as an external identity source as part of the configuration for features such as Easy Connect and the PassiveID Work Center. For more information about these features, see [Easy Connect, on page 357](#) and [PassiveID Work Center, on page 361](#).

Before you configure Active Directory as an External Identity Source, make sure that:

- The Microsoft Active Directory server does not reside behind a network address translator and does not have a Network Address Translation (NAT) address.
- The Microsoft Active Directory account intended for the join operation is valid and is not configured with the Change Password on Next Login.
- You have the privileges of a Super Admin or System Admin in ISE.



---

**Note** If you see operational issues when Cisco ISE is connected to Active Directory, see the AD Connector Operations Report under **Operations > Reports**.

---

You must perform the following tasks to configure Active Directory as an external identity source.

1. [Add an Active Directory Join Point and Join Cisco ISE Node to the Join Point, on page 329](#)
2. [Configure Authentication Domains, on page 333](#)
3. [Configure Active Directory User Groups, on page 334](#)
4. [Configure Active Directory User and Machine Attributes, on page 335](#)
5. (Optional) [Modify Password Changes, Machine Authentications, and Machine Access Restriction Settings, on page 335](#)

## Add an Active Directory Join Point and Join Cisco ISE Node to the Join Point

### Before you begin

Ensure that the Cisco ISE node can communicate with the networks where the NTP servers, DNS servers, domain controllers, and global catalog servers are located. You can check these parameters by running the Domain Diagnostic tool.

Join points must be created in order to work with Active Directory as well as with the Agent, Syslog, SPAN and Endpoint probes of the Passive ID Work Center.

- 
- Step 1** Choose **Administration > Identity Management > External Identity Sources > Active Directory**.
- Step 2** Click **Add** and enter the domain name and identity store name from the **Active Directory Join Point Name** settings.
- Step 3** Click **Submit**.
- A pop-up appears asking if you want to join the newly created join point to the domain. Click **Yes** if you want to join immediately.
- If you clicked **No**, then saving the configuration saves the Active Directory domain configuration globally (in the primary and secondary policy service nodes), but none of the Cisco ISE nodes are joined to the domain yet.
- Step 4** Check the check box next to the new Active Directory join point that you created and click **Edit**, or click on the new Active Directory join point from the navigation pane on the left. The deployment join/leave table is displayed with all the Cisco ISE nodes, the node roles, and their status.
- Step 5** In case the join point was not joined to the domain during Step 3, check the check box next to the relevant Cisco ISE nodes and click **Join** to join the Cisco ISE node to the Active Directory domain.
- You must do this explicitly even though you saved the configuration. To join multiple Cisco ISE nodes to a domain in a single operation, the username and password of the account to be used must be the same for all join operations. If different username and passwords are required to join each Cisco ISE node, the join operation should be performed individually for each Cisco ISE node.
- Step 6** Enter the Active Directory username and password in the **Join Domain** dialog box.
- It is strongly recommended that you choose **Store credentials**, in which case your administrator's user name and password will be saved in order to be used for all Domain Controllers (DC) that are configured for monitoring.
- The user used for the join operation should exist in the domain itself. If it exists in a different domain or subdomain, the username should be noted in a UPN notation, such as `jdoe@acme.com`.
- Step 7** (Optional) Check the **Specify Organizational Unit** check box.
- You should check this check box in case the Cisco ISE node machine account is to be located in a specific Organizational Unit other than `CN=Computers,DC=someDomain,DC=someTLD`. Cisco ISE creates the machine account under the specified organizational unit or moves it to this location if the machine account already exists. If the organizational unit is not specified, Cisco ISE uses the default location. The value should be specified in full distinguished name (DN) format. The syntax must conform to the Microsoft guidelines. Special reserved characters, such as `/+;,=<>` line feed, space, and carriage return must be escaped by a backslash (`\`). For example, `OU=Cisco ISE\,US,OU=IT Servers,OU=Servers\, and Workstations,DC=someDomain,DC=someTLD`. If the machine account is already created, you need not check this check box. You can also change the location of the machine account after you join to the Active Directory domain.
- Step 8** Click **OK**.
- You can select more than one node to join to the Active Directory domain.
- If the join operation is not successful, a failure message appears. Click the failure message for each node to view detailed logs for that node.
- Note** When the join is complete, Cisco ISE updates its AD groups and corresponding security identifiers (SIDs). Cisco ISE automatically starts the SID update process. You must ensure that this process is allowed to complete.

**Note** You might not be able to join Cisco ISE with an Active Directory domain if the DNS service (SRV) records are missing (the domain controllers do not advertise their SRV records for the domain that you are trying to join to). Refer to the following Microsoft Active Directory documentation for troubleshooting information:

- <http://support.microsoft.com/kb/816587>
- <http://technet.microsoft.com/en-us/library/bb727055.aspx>

---

## Add Domain Controllers

---

- Step 1** Choose **Work Centers > PassiveID > Providers** and then from the left panel choose **Active Directory**.
- Step 2** Check the check box next to the Active Directory join point that you created and click **Edit**. The deployment join/leave table is displayed with all the Cisco ISE nodes, the node roles, and their statuses.
- Step 3** **Note** To add a new Domain Controller (DC) for Passive Identity services, you need the login credentials of that DC.
- Go to the PassiveID tab and click **Add DCs**.
- Step 4** Check the check box next to the domain controllers that you would like to add to the join point for monitoring and click **OK**.  
The domain controllers appear in the Domain Controllers list of the PassiveID tab.
- Step 5** Configure the domain controller:
- a) Checkmark the domain controller and click **Edit**. The **Edit Item** screen appears.
  - b) Optionally, edit the different domain controller fields.
  - c) If you selected WMI protocol, click **Configure** to configure WMI automatically and click **Test** to test the connection.

---

## Configure WMI for Passive ID

### Before you begin

Ensure you have Active Directory Domain Admin credentials, required in order to make changes to any of the AD domain configurations. Ensure that you enabled Passive ID for this node under **Administration > System > Deployment**.

Figure 27:

Deployment Nodes List > atlantis

**Edit Node**

General Settings Profiling Configuration

Hostname :  
FQDN atlantis.rtpaaa.net  
IP Address  
Node Type Identity Services Engine (ISE)

Administration Role **STANDALONE**

Monitoring Role **PRIMARY** Other Monitoring Node

Policy Service

Enable Session Services  Include Node in Node Group **None**

Enable Profiling Service

Enable Threat Centric NAC Service

Enable SXP Service  Use Interface **GigabitEthernet 0**

Enable Device Admin Service

Enable Passive Identity Service  **Passive Identity Service**  
Passive Identity Service enables an enterprise to connect to domain controllers and subscribe to authentication events.

pxGrid

- Step 1** Choose **Administration** > **Identity Management** > **External Identity Sources** > **Active Directory**.
- Step 2** Check the check box next to the Active Directory join point that you created and click **Edit**. The deployment join/leave table is displayed with all the Cisco ISE nodes, the node roles, and their statuses.
- Step 3** Go to the Passive ID tab, check the check box next to the relevant domain controllers and click **Config WMI** to enable ISE to automatically configure the domain controllers you selected.

Figure 28:

**Edit Item**

**Edit Domain Controller**

Host FQDN

Description

User Name \* admin

Password \*\*\*\*\*

Protocol **WMI**

**The connection was tested on 'atlantis.rtpaaa.net' PassiveID active node. Connection to successfully. established. Windows version is 'Win2012R2', NetBIOS domain is 'RTPAAA'. Query for history events succeeded.**

To configure Active Directory and Domain Controllers manually, or to troubleshoot any problems with configuration, see [Prerequisites for Integrating Active Directory and Cisco ISE](#), on page 326.



Figure 29:

---

## Leave the Active Directory Domain

If you no longer need to authenticate users or machines from this Active Directory domain or from this join point, you can leave the Active Directory domain.

When you reset the Cisco ISE application configuration from the command-line interface or restore configuration after a backup or upgrade, it performs a leave operation, disconnecting the Cisco ISE node from the Active Directory domain, if it is already joined. However, the Cisco ISE node account is not removed from the Active Directory domain. We recommend that you perform a leave operation from the Admin portal with the Active Directory credentials because it also removes the node account from the Active Directory domain. This is also recommended when you change the Cisco ISE hostname.

### Before you begin

If you leave the Active Directory domain, but still use Active Directory as an identity source for authentication (either directly or as part of an identity source sequence), authentications may fail.

- 
- Step 1** Choose **Administration > Identity Management > External Identity Sources > Active Directory**.
  - Step 2** Check the checkbox next to the Active Directory join point that you created and click **Edit**. The deployment join/leave table is displayed with all the Cisco ISE nodes, the node roles, and their statuses.
  - Step 3** Check the checkbox next to the Cisco ISE node and click **Leave**.
  - Step 4** Enter the Active Directory username and password, and click **OK** to leave the domain and remove the machine account from the Cisco ISE database.

If you enter the Active Directory credentials, the Cisco ISE node leaves the Active Directory domain and deletes the Cisco ISE machine account from the Active Directory database.

**Note** To delete the Cisco ISE machine account from the Active Directory database, the Active Directory credentials that you provide here must have the permission to remove machine account from domain.

- Step 5** If you do not have the Active Directory credentials, check the **No Credentials Available** checkbox, and click **OK**.  
If you check the **Leave domain without credentials** checkbox, the primary Cisco ISE node leaves the Active Directory domain. The Active Directory administrator must manually remove the machine account that was created in Active Directory during the time of the join.

---

## Configure Authentication Domains

The domain to which Cisco ISE is joined to has visibility to other domains with which it has a trust relationship. By default, Cisco ISE is set to permit authentication against all those trusted domains. You can restrict interaction with the Active Directory deployment to a subset of authentication domains. Configuring authentication domains enables you to select specific domains for each join point so that the authentications are performed against the selected domains only. Authentication domains improves security because they instruct Cisco ISE to authenticate users only from selected domains and not from all domains trusted from join point. Authentication domains also improve performance and latency of authentication request processing because authentication domains limit the search area (that is, where accounts matching to incoming username

or identity will be searched). It is especially important when incoming username or identity does not contain domain markup (prefix or suffix). Due to these reasons, configuring authentication domains is a best practice, and we highly recommended it.

- 
- Step 1** Choose **Administration > Identity Management > External Identity Sources > Active Directory**.
- Step 2** Click **Active Directory** join point.
- Step 3** Click the **Authentication Domains** tab.
- A table appears with a list of your trusted domains. By default, Cisco ISE permits authentication against all trusted domains.
- Step 4** To allow only specified domains, uncheck **Use all Active Directory domains for authentication** check box.
- Step 5** Check the check box next to the domains for which you want to allow authentication, and click **Enable Selected**. In the **Authenticate** column, the status of this domain changes to Yes.
- You can also disable selected domains.
- Step 6** Click **Show Unusable Domains** to view a list of domains that cannot be used. Unusable domains are domains that Cisco ISE cannot use for authentication due to reasons such as one-way trust, selective authentication and so on.
- 

### What to do next

Configure Active Directory user groups.

## Configure Active Directory User Groups

You must configure Active Directory user groups for them to be available for use in authorization policies. Internally, Cisco ISE uses security identifiers (SIDs) to help resolve group name ambiguity issues and to enhance group mappings. SID provides accurate group assignment matching.

- 
- Step 1** Choose **Administration > Identity Management > External Identity Sources > Active Directory**.
- Step 2** Click the **Groups** tab.
- Step 3** Do one of the following:
- Choose **Add > Select Groups From Directory** to choose an existing group.
  - Choose **Add > Add Group** to manually add a group. You can either provide both group name and SID or provide only the group name and press **Fetch SID**.
- Do not use double quotes (") in the group name for the user interface login.
- Step 4** If you are manually selecting a group, you can search for them using a filter. For example, enter **admin\*** as the filter criteria and click **Retrieve Groups** to view user groups that begin with admin. You can also enter the asterisk (\*) wildcard character to filter the results. You can retrieve only 500 groups at a time.
- Step 5** Check the check boxes next to the groups that you want to be available for use in authorization policies and click **OK**.
- Step 6** If you choose to manually add a group, enter a name and SID for the new group.
- Step 7** Click **OK**.
- Step 8** Click **Save**.

**Note** If you delete a group and create a new group with the same name as original, you must click **Update SID Values** to assign new SID to the newly created group. After an upgrade, the SIDs are automatically updated after the first join.

---

### What to do next

Configure Active Directory user attributes.

## Configure Active Directory User and Machine Attributes

You must configure Active Directory user and machine attributes to be able to use them in conditions in authorization policies.

---

- Step 1** Choose **Administration** > **Identity Management** > **External Identity Sources** > **Active Directory**.
- Step 2** Click the **Attributes** tab.
- Step 3** Choose **Add** > **Add Attribute** to manually add a attribute, or choose **Add** > **Select Attributes From Directory** to choose a list of attributes from the directory.
- Step 4** If you choose to add attributes from the directory, enter the name of a user in the **Sample User or Machine Account** field, and click **Retrieve Attributes** to obtain a list of attributes for users. For example, enter **administrator** to obtain a list of administrator attributes. You can also enter the asterisk (\*) wildcard character to filter the results.
- Note** When you enter an example username, ensure that you choose a user from the Active Directory domain to which the Cisco ISE is connected. When you choose an example machine to obtain machine attributes, be sure to prefix the machine name with “host/” or use the SAM\$ format. For example, you might use host/myhost. The example value displayed when you retrieve attributes are provided for illustration only and are not stored.
- Step 5** Check the check boxes next to the attributes from Active Directory that you want to select, and click **OK**.
- Step 6** If you choose to manually add an attribute, enter a name for the new attribute.
- Step 7** Click **Save**.
- 

## Modify Password Changes, Machine Authentications, and Machine Access Restriction Settings

### Before you begin

You must join Cisco ISE to the Active Directory domain. For more information, see [Add an Active Directory Join Point and Join Cisco ISE Node to the Join Point, on page 329](#).

---

- Step 1** Choose **Administration** > **Identity Management** > **External Identity Sources** > **Active Directory**.
- Step 2** Check the check box next to the relevant Cisco ISE node and click **Edit** .
- Step 3** Click the **Advanced Settings** tab.
- Step 4** Modify as required, the Password Change, Machine Authentication, and Machine Access Restrictions (MARs) settings.
- Step 5** Check the **Enable dial-in check** check box to check the dial-in permissions of the user during authentication or query. The result of the check can cause a reject of the authentication in case the dial-in permission is denied.

- Step 6** Check the **Enable callback check for dial-in clients** check box if you want the server to call back the user during authentication or query. The IP address or phone number used by the server can be set either by the caller or the network administrator. The result of the check is returned to the device on the RADIUS response.
- Step 7** Check the **Use Kerberos for Plain Text Authentications** check box if you want to use Kerberos for plain-text authentications. The default and recommended option is MS-RPC.
- 

## Machine Access Restriction Cache

Cisco ISE stores the Machine Access Restriction (MAR) cache content, calling-station-ID list, and the corresponding time stamps to a file on its local disk when you manually stop the application services. Cisco ISE does not store the MAR cache entries of an instance when there is an accidental restart of the application services. Cisco ISE reads the MAR cache entries from the file on its local disk based on the cache entry time to live when the application services restart. When the application services come up after a restart, Cisco ISE compares the current time of that instance with the MAR cache entry time. If the difference between the current time and the MAR entry time is greater than the MAR cache entry time to live, then Cisco ISE does not retrieve that entry from disk. Otherwise, Cisco ISE retrieves that MAR cache entry and updates its MAR cache entry time to live.

### To Configure MAR Cache

On **Advanced Settings** tab of the Active Directory defined in External Identity Sources, verify that the following options are checked:

- **Enable Machine Authentication:** To enable machine authentication.
- **Enable Machine Access Restriction:** To combine user and machine authentication before authorization.

### To Use MAR Cache in Authorization

Use `WasMachineAuthenticated is True` in an authorization policy. You can use this rule plus a credentials rule to do dual-authentication. Machine authentication must be done before AD credentials.

If you created a Node Group on the **System > Deployment** page, enable MAR Cache Distribution. MAR cache distribution replicates the MAR cache to all the PSNs in the same node group.

For more information, see the following Cisco ISE Community pages:

- <https://community.cisco.com/t5/policy-and-access/mar-why-is-it-useful/td-p/3213527>
- <https://community.cisco.com/t5/policy-and-access/ise-2-1-mar-aging-time-eap-tls/td-p/3209628>

### Related Topics

[Configure Active Directory as an External Identity Source](#), on page 329

## Configure Custom Schema

### Before you begin

You must join Cisco ISE to the Active Directory domain.

- 
- Step 1** Choose **Administration** > **Identity Management** > **External Identity Sources** > **Active Directory**.
- Step 2** Select the Join point.
- Step 3** Click the **Advanced Settings** tab.
- Step 4** Under the **Schema** section, select the **Custom** option from the **Schema** drop-down list. You can update the user information attributes based on your requirements. These attributes are used to collect user information, such as, first name, last name, email, telephone, locality, and so on.
- Predefined attributes are used for the Active Directory schema (built-in schema). If you edit the attributes of the predefined schema, Cisco ISE automatically creates a custom schema.
- 

## Support for Active Directory Multijoin Configuration

Cisco ISE supports multiple joins to Active Directory domains. Cisco ISE supports up to 50 Active Directory joins. Cisco ISE can connect with multiple Active Directory domains that do not have a two-way trust or have zero trust between them. Active Directory multi-domain join comprises a set of distinct Active Directory domains with their own groups, attributes, and authorization policies for each join.

You can join the same forest more than once, that is, you can join more than one domain in the same forest, if necessary.

Cisco ISE now allows to join domains with one-way trust. This option helps bypass the permission issues caused by a one-way trust. You can join either of the trusted domains and hence be able to see both domains.

- **Join Point:** In Cisco ISE, each independent join to an Active Directory domain is called a join point. The Active Directory join point is an Cisco ISE identity store and can be used in authentication policy. It has an associated dictionary for attributes and groups, which can be used in authorization conditions.
- **Scope:** A subset of Active Directory join points grouped together is called a scope. You can use scopes in authentication policy in place of a single join point and as authentication results. Scopes are used to authenticate users against multiple join points. Instead of having multiple rules for each join point, if you use a scope, you can create the same policy with a single rule and save the time that Cisco ISE takes to process a request and help improve performance. A join point can be present in multiple scopes. A scope can be included in an identity source sequence. You cannot use scopes in an authorization policy condition because scopes do not have any associated dictionaries.

When you perform a fresh Cisco ISE install, by default no scopes exist. This is called the no scope mode. When you add a scope, Cisco ISE enters multi-scope mode. If you want, you can return to no scope mode. All the join points will be moved to the Active Directory folder.

- **Initial\_Scope** is an implicit scope that is used to store the Active Directory join points that were added in no scope mode. When multi-scope mode is enabled, all the Active Directory join points move into the automatically created **Initial\_Scope**. You can rename the **Initial\_Scope**.
- **All\_AD\_Instances** is a built-in pseudo scope that is not shown in the Active Directory configuration. It is only visible as an authentication result in policy and identity sequences. You can select this scope if you want to select all Active Directory join points configured in Cisco ISE.

## Create a New Scope to Add Active Directory Join Points

- 
- Step 1** Choose **Administration > Identity Management > External Identity Sources > Active Directory**.
- Step 2** Click **Scope Mode**.  
A default scope called Initial\_Scope is created, and all the current join points are placed under this scope.
- Step 3** To create more scopes, click **Add**.
- Step 4** Enter a name and a description for the new scope.
- Step 5** Click **Submit**.
- 

## Identity Rewrite

Identity rewrite is an advanced feature that directs Cisco ISE to manipulate the identity before it is passed to the external Active Directory system. You can create rules to change the identity to a desired format that includes or excludes a domain prefix and/or suffix or other additional markup of your choice.

Identity rewrite rules are applied on the username or hostname received from the client, before being passed to Active Directory, for operations such as subject searches, authentication, and authorization queries. Cisco ISE will match the condition tokens and when the first one matches, Cisco ISE stops processing the policy and rewrites the identity string according to the result.

During the rewrite, everything enclosed in square bracket [ ] (such as [IDENTITY]) is a variable that is not evaluated on the evaluation side but instead added with the string that matches that location in the string. Everything without the brackets is evaluated as a fixed string on both the evaluation side and the rewrite side of the rule.

The following are some examples of identity rewrite, considering that the identity entered by the user is ACME\jdoe:

- If identity matches **ACME\[IDENTITY]**, rewrite as **[IDENTITY]**.  
The result would be jdoe. This rule instructs Cisco ISE to strip all usernames with the ACME prefix.
- If the identity matches **ACME\[IDENTITY]**, rewrite as **[IDENTITY]@ACME.com**.  
The result would be jdoe@ACME.com. This rule instructs Cisco ISE to change the format from prefix for suffix notation or from NetBIOS format to UPN formats.
- If the identity matches **ACME\[IDENTITY]**, rewrite as **ACME2\[IDENTITY]**.  
The result would be ACME2\jdoe. This rule instructs Cisco ISE to change all usernames with a certain prefix to an alternate prefix.
- If the identity matches **[ACME]\jdoe.USA**, rewrite as **[IDENTITY]@[ACME].com**.  
The result would be jdoe\ACME.com. This rule instructs Cisco ISE to strip the realm after the dot, in this case the country and replace it with the correct domain.
- If the identity matches **E=[IDENTITY]**, rewrite as **[IDENTITY]**.  
The result would be jdoe. This is an example rule that can be created when an identity is from a certificate, the field is an email address, and Active Directory is configured to search by Subject. This rule instructs Cisco ISE to remove 'E='.

- If the identity matches **E=[EMAIL],[DN]**, rewrite as **[DN]**.

This rule will convert certificate subject from E=jdoe@acme.com, CN=jdoe, DC=acme, DC=com to pure DN, CN=jdoe, DC=acme, DC=com. This is an example rule that can be created when identity is taken from a certificate subject and Active Directory is configured to search user by DN. This rule instructs Cisco ISE to strip email prefix and generate DN.

The following are some common mistakes while writing the identity rewrite rules:

- If the identity matches **[DOMAIN]\[IDENTITY]**, rewrite as **[IDENTITY]@DOMAIN.com**.

The result would be jdoe@DOMAIN.com. This rule does not have [DOMAIN] in square brackets [ ] on the rewrite side of the rule.

- If the identity matches **DOMAIN\[IDENTITY]**, rewrite as **[IDENTITY]@[DOMAIN].com**.

Here again, the result would be jdoe@DOMAIN.com. This rule does not have [DOMAIN] in square brackets [ ] on the evaluation side of the rule.

Identity rewrite rules are always applied within the context of an Active Directory join point. Even if a scope is selected as the result of an authentication policy, the rewrite rules are applied for each Active Directory join point. These rewrite rules also applies for identities taken from certificates if EAP-TLS is being used.

## Enable Identity Rewrite



**Note** This configuration task is optional. You can perform it to reduce authentication failures that can arise because of various reasons such as ambiguous identity errors.

### Before you begin

You must join Cisco ISE to the Active Directory domain.

- 
- Step 1** Choose **Administration > Identity Management > External Identity Sources > Active Directory**.
  - Step 2** Click the **Advanced Settings** tab.
  - Step 3** Under the **Identity Rewrite** section, choose whether you want to apply the rewrite rules to modify usernames.
  - Step 4** Enter the match conditions and the rewrite results. You can remove the default rule that appears and enter the rule according to your requirement. Cisco ISE processes the policy in order, and the first condition that matches the request username is applied. You can use the matching tokens (text contained in square brackets) to transfer elements of the original username to the result. If none of the rules match, the identity name remains unchanged. You can click the **Launch Test** button to preview the rewrite processing.
- 

## Identity Resolution Settings

Some type of identities include a domain markup, such as a prefix or a suffix. For example, in a NetBIOS identity such as ACME\jdoe, “ACME” is the domain markup prefix, similarly in a UPN identity such as jdoe@acme.com, “acme.com” is the domain markup suffix. Domain prefix should match to the NetBIOS (NTLM) name of the Active Directory domain in your organization and domain suffix should match to the

DNS name of Active Directory domain or to the alternative UPN suffix in your organization. For example `jdoe@gmail.com` is treated as without domain markup because `gmail.com` is not a DNS name of Active Directory domain.

The identity resolution settings allows you to configure important settings to tune the security and performance balance to match your Active Directory deployment. You can use these settings to tune authentications for usernames and hostnames without domain markup. In cases when Cisco ISE is not aware of the user's domain, it can be configured to search the user in all the authentication domains. Even if the user is found in one domain, Cisco ISE will wait for all responses in order to ensure that there is no identity ambiguity. This might be a lengthy process, subject to the number of domains, latency in the network, load, and so on.

## Avoid Identity Resolution Issues

It is highly recommended to use fully qualified names (that is, names with domain markup) for users and hosts during authentication. For example, UPNs and NetBIOS names for users and FQDN SPNs for hosts. This is especially important if you hit ambiguity errors frequently, such as, several Active Directory accounts match to the incoming username; for example, `jdoe` matches to `jdoe@emea.acme.com` and `jdoe@amer.acme.com`. In some cases, using fully qualified names is the only way to resolve issue. In others, it may be sufficient to guarantee that the users have unique passwords. So, it is more efficient and leads to less password lockout issues if unique identities are used initially.

## Configure Identity Resolution Settings




---

**Note** This configuration task is optional. You can perform it to reduce authentication failures that can arise because of various reasons such as ambiguous identity errors.

---

### Before you begin

You must join the Cisco ISE node to the Active Directory domain.

- 
- Step 1** Choose **Administration > Identity Management > External Identity Sources > Active Directory**.
  - Step 2** Click the **Advanced Settings** tab.
  - Step 3** Define the following settings for identity resolution for usernames or machine names under the **Identity Resolution** section. This setting provides you advanced control for user search and authentication.

The first setting is for the identities without a markup. In such cases, you can select any of the following options:

- **Reject the request:** This option will fail the authentication for users who do not have any domain markups, such as a SAM name. This is useful in case of multi join domains where Cisco ISE will have to look up for the identity in all the joined global catalogs, which might not be very secure. This option forces the users to use names with domain markups.
- **Only search in the “Authentication Domains” from the joined forest:** This option will search for the identity only in the domains in the forest of the join point which are specified in the authentication domains section. This is the default option and identical to Cisco ISE 1.2 behavior for SAM account names.
- **Search in all the “Authentication Domains” sections:** This option will search for the identity in all authentication domains in all the trusted forests. This might increase latency and impact performance.

The selection is made based on how the authentication domains are configured in Cisco ISE. If only specific authentication domains are selected, only those domains will be searched (for both “joined forest” or “all forests” selections).



The second setting is used if Cisco ISE cannot communicate with all Global Catalogs (GCs) that it needs to in order to comply with the configuration specified in the “Authentication Domains” section. In such cases, you can select any of the following options:

- **Proceed with available domains:** This option will proceed with the authentication if it finds a match in any of the available domains.
- **Drop the request:** This option will drop the authentication request if the identity resolution encounters some unreachable or unavailable domain.

---

## Test Users for Active Directory Authentication

The Test User tool can be used to verify user authentication from Active Directory. You can also fetch groups and attributes and examine them. You can run the test for a single join point or for scopes.

---

**Step 1** Choose **Administration > Identity Management > External Identity Sources > Active Directory**.

**Step 2** Choose one of the following options:

- To run the test on all join points, choose **Advanced Tools > Test User for All Join Points**.
- To run the test for a specific join point, select the joint point and click **Edit**. Select the Cisco ISE node and click **Test User**.

**Step 3** Enter the username and password of the user (or host) in Active Directory.

**Step 4** Choose the authentication type. Password entry in Step 3 is not required if you choose the Lookup option.

**Step 5** Select the Cisco ISE node on which you want to run this test, if you are running this test for all join points.

**Step 6** Check the Retrieve Groups and Attributes check boxes if you want to retrieve the groups and attributes from Active Directory.

**Step 7** Click **Test**.

The result and steps of the test operation are displayed. The steps can help to identify the failure reason and troubleshoot.

You can also view the time taken (in milliseconds) for Active Directory to perform each processing step (for authentication, lookup, or fetching groups/attributes). Cisco ISE displays a warning message if the time taken for an operation exceeds the threshold.

---

## Delete Active Directory Configurations

You should delete Active Directory configurations if you are not going to use Active Directory as an external identity source. Do not delete the configuration if you want to join another Active Directory domain. You can leave the domain to which you are currently joined and join a new domain.

### Before you begin

Ensure that you have left the Active Directory domain.

---

**Step 1** Choose **Administration > Identity Management > External Identity Sources > Active Directory**.

- Step 2** Check the checkbox next to the configured Active Directory.
- Step 3** Check and ensure that the Local Node status is listed as Not Joined.
- Step 4** Click **Delete**.

You have removed the configuration from the Active Directory database. If you want to use Active Directory at a later point in time, you can resubmit a valid Active Directory configuration.

## View Active Directory Joins for a Node

You can use the **Node View** button on the **Active Directory** page to view the status of all Active Directory join points for a given Cisco ISE node or a list of all join points on all Cisco ISE nodes.

- Step 1** Choose **Administration > Identity Management > External Identity Sources > Active Directory**.
- Step 2** Click **Node View**.
- Step 3** Select a node from the **ISE Node** drop-down list.  
The table lists the status of Active Directory by node. If there are multiple join points and multiple Cisco ISE nodes in a deployment, this table may take several minutes to update.
- Step 4** Click the join point **Name** link to go to that Active Directory join point page and perform other specific actions.
- Step 5** Click the link in the **Diagnostic Summary** column to go to the **Diagnostic Tools** page to troubleshoot specific issues. The diagnostic tool displays the latest diagnostics results for each join point per node.

## Diagnose Active Directory Problems

The Diagnostic Tool is a service that runs on every Cisco ISE node. It allows you to automatically test and diagnose the Active Directory deployment and execute a set of tests to detect issues that may cause functionality or performance failures when Cisco ISE uses Active Directory.

There are multiple reasons for which Cisco ISE might be unable to join or authenticate against Active Directory. This tool helps ensure that the prerequisites for connecting Cisco ISE to Active Directory are configured correctly. It helps detect problems with networking, firewall configurations, clock sync, user authentication, and so on. This tool works as a step-by-step guide and helps you fix problems with every layer in the middle, if needed .

- Step 1** Choose **Administration > Identity Management > External Identity Sources > Active Directory**.
- Step 2** Click the **Advanced Tools** drop-down and choose **Diagnostic Tools**.
- Step 3** Select a Cisco ISE node to run the diagnosis on.  
If you do not select a Cisco ISE node then the test is run on all the nodes.
- Step 4** Select a specific Active Directory join point.  
If you do not select an Active Directory join point then the test is run on all the join points.
- Step 5** Click **Run All Tests on Node** to start the test.
- Step 6** Click **View Test Details** to view the details for tests with Warning or Failed status.

This table allows you to rerun specific tests, stop running tests, and view a report of specific tests.

---

## Enable Active Directory Debug Logs

Active Directory debug logs are not logged by default. You must enable this option on the Cisco ISE node that has assumed the Policy Service persona in your deployment. Enabling Active Directory debug logs may affect ISE performance.

---

- Step 1** Choose **Administration** > **System** > **Logging** > **Debug Log Configuration**.
  - Step 2** Click the radio button next to the Cisco ISE Policy Service node from which you want to obtain Active Directory debug information, and click **Edit**.
  - Step 3** Click the **Active Directory** radio button, and click **Edit**.
  - Step 4** Choose **DEBUG** from the drop-down list next to Active Directory. This will include errors, warnings, and verbose logs. To get full logs, choose **TRACE**.
  - Step 5** Click **Save**.
- 

## Obtain the Active Directory Log File for Troubleshooting

Download and view the Active Directory debug logs to troubleshoot issues you may have.

### Before you begin

Active Directory debug logging must be enabled.

---

- Step 1** Choose **Operations** > **Troubleshoot** > **Download Logs**.
  - Step 2** Click the node from which you want to obtain the Active Directory debug log file.
  - Step 3** Click the **Debug Logs** tab.
  - Step 4** Scroll down this page to locate the ad\_agent.log file. Click this file to download it.
- 

## Active Directory Alarms and Reports

Cisco ISE provides various alarms and reports to monitor and troubleshoot Active Directory related activities.

### Alarms

The following alarms are triggered for Active Directory errors and issues:

- Configured nameserver not available
- Joined domain is unavailable
- Authentication domain is unavailable

- Active Directory forest is unavailable
- AD Connector had to be restarted
- AD: ISE account password update failed
- AD: Machine TGT refresh failed

## Reports

You can monitor Active Directory related activities through the following two reports:

- **RADIUS Authentications** report: This report shows detailed steps of the Active Directory authentication and authorization. You can find this report here: **Operations > Reports > Auth Services Status > RADIUS Authentications**.
- **AD Connector Operations** report: The AD Connector Operations report provides a log of background operations performed by AD connector, such as Cisco ISE server password refresh, Kerberos ticket management, DNS queries, DC discovery, LDAP, and RPC connections management. If you encounter any Active Directory failures, you can review the details in this report to identify the possible causes. You can find this report here: **Operations > Reports > Auth Services Status > AD Connector Operations**.

## Active Directory Advanced Tuning

The advanced tuning feature provides node-specific settings used for support action under the supervision of Cisco support personnel, to adjust the parameters deeper in the system. These settings are not intended for normal administration flow, and should be used only under guidance.

## Active Directory Identity Search Attributes

Cisco ISE identifies users using the attributes SAM, CN, or both. Cisco ISE, Release 2.2 Patch 5 and above, and 2.3 Patch 2 and above, use sAMAccountName attribute as the default attribute. In earlier releases, both SAM and CN attributes were searched by default. This behavior has changed in Release 2.2 Patch 5 and above, and 2.3 Patch 2 and above, as part of [CSCvf21978](#) bug fix. In these releases, only the sAMAccountName attribute is used as the default attribute.

You can configure Cisco ISE to use SAM, CN, or both, if your environment requires it. When SAM and CN are used, and the value of the sAMAccountName attribute is not unique, Cisco ISE also compares the CN attribute value.

### Configure Attributes for Active Directory Identity Search

1. Choose **Administration > Identity Management > External Identity Sources > Active Directory** .
2. In the **Active Directory** window, click **Advanced Tools**, and choose **Advanced Tuning**. Enter the following details:
  - **ISE Node**: Choose the ISE node that is connecting to Active Directory.
  - **Name**: Enter the registry key that you are changing. To change the Active Directory search attributes, enter: `REGISTRY\Services\lsass\Parameters\Providers\ActiveDirectory\IdentityLookupField`
  - **Value**: Enter the attributes that ISE uses to identify a user:

- *SAM*: To use only SAM in the query (this option is the default).
  - *CN*: To use only CN in the query.
  - *SAMCN*: To use CN and SAM in the query.
- **Comment**: Describe what you are changing, for example: Changing the default behavior to SAM and CN

3. Click **Update Value** to update the registry.

A pop-up window appears. Read the message and accept the change. The AD connector service in ISE restarts.

### Example Search Strings

For the following examples, assume that the username is *userd2only*:

- SAM search string—

```
filter=[(&(| (objectCategory=person) (objectCategory=computer)) (| (cn=userd2only) (sAMAccountName=userd2only)))]
```

- SAM and CN search string—

```
filter=[(&(| (objectCategory=person) (objectCategory=computer)) (sAMAccountName=userd2only))]
```

## Supplemental Information for Setting Up Cisco ISE with Active Directory

For configuring Cisco ISE with Active Directory, you must configure group policies, and configure a supplicant for machine authentication.

### Configure Group Policies in Active Directory

For more information about how to access the Group Policy management editor, refer to the Microsoft Active Directory documentation.

**Step 1** Open the Group Policy management editor as shown in the following illustration.

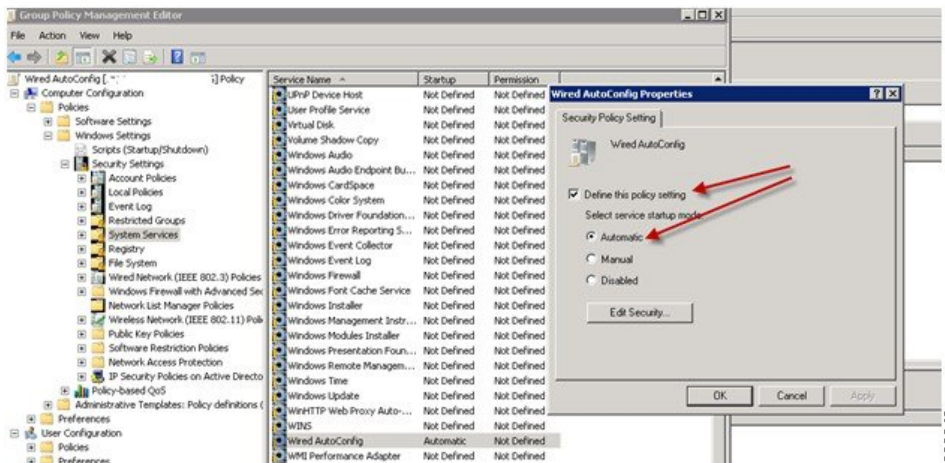


**Step 2** Create a new policy and enter a descriptive name for it or add to an existing domain policy.

In example below, we used Wired Autoconfiguration for the policy name.

**Step 3** Check the **Define this policy setting** check box, and click the **Automatic** radio button for the service startup mode as shown in the following illustration.

## Configure Odyssey 5.X Supplicant for EAP-TLS Machine Authentications Against Active Directory



**Step 4** Apply the policy at the desired organizational unit or domain Active Directory level.

## Configure Odyssey 5.X Supplicant for EAP-TLS Machine Authentications Against Active Directory

If you are using the Odyssey 5.x supplicant for EAP-TLS machine authentications against Active Directory, you must configure the following in the supplicant.

**Step 1** Start Odyssey Access Client.

**Step 2** Choose **Odyssey Access Client Administrator** from the Tools menu.

**Step 3** Double-click the **Machine Account** icon.

**Step 4** From the **Machine Account** window, you must configure a profile for EAP-TLS authentications:

- Choose **Configuration > Profiles**.
- Enter a name for the EAP-TLS profile.
- On the Authentication tab, choose **EAP-TLS** as the authentication method.
- On the Certificate tab, check the **Permit login using my certificate** check box, and choose a certificate for the supplicant machine.
- On the **User Info** tab, check the **Use machine credentials** check box.

If this option is enabled, the Odyssey supplicant sends the machine name in the format `host<machine_name>` and Active Directory identifies the request as coming from a machine and will look up computer objects to perform authentication. If this option is disabled, the Odyssey supplicant sends the machine name without the `host\` prefix and Active Directory will look up user objects and the authentication fails.

## AnyConnect Agent for Machine Authentication

When you configure AnyConnect Agent for machine authentication, you can do one of the following:

- Use the default machine hostname, which includes the prefix “host/.”
- Configure a new profile, in which case you must include the prefix “host/” and then the machine name.

# Active Directory Requirements to Support Easy Connect and Passive Identity services

Easy Connect and Passive Identity services use Active Directory login audit events generated by the Active Directory domain controller to gather user login information. The Active Directory server must be configured properly so the ISE user can connect and fetch the user login information. The following sections show how to configure the Active Directory domain controller (configurations from the Active Directory side) to support Easy Connect and Passive Identity services.

To configure Active Directory domain controllers (configurations from the Active Directory side) to support Easy Connect and Passive Identity services, follow these steps:



---

**Note** You must configure all the domain controllers in all the domains.

---

1. Set up Active Directory join points and domain controllers from ISE. See [Add an Active Directory Join Point and Join Cisco ISE Node to the Join Point, on page 329](#) and [#unique\\_537](#).
2. Configure WMI per domain controller. See [#unique\\_538](#).
3. Perform the following steps from Active Directory:
  - [Configure Active Directory for Passive Identity service, on page 347](#)
  - [Set the Windows Audit Policy, on page 350](#)
4. (Optional) Troubleshoot automatic configurations performed by ISE on Active Directory with these steps:
  - [Set Permissions when Microsoft Active Directory Users are in Domain Admin Group, on page 254](#)
  - [Permissions for Microsoft Active Directory Users Not in Domain Admin Group, on page 255](#)
  - [Permissions to Use DCOM on the Domain Controller, on page 256](#)
  - [Set Permissions for Access to WMI Root and CIMv2 Namespace, on page 258](#)
  - [Grant Access to the Security Event Log in the AD Domain Controller, on page 355](#)

## Configure Active Directory for Passive Identity service

ISE Easy Connect and Passive Identity services use Active Directory login audit events generated by the Active Directory domain controller to gather user login information. ISE connects to Active Directory and fetches the user login information.

The following steps should be performed from the Active Directory domain controller:

- 
- Step 1** Make sure relevant Microsoft patches are installed on the Active Directory domain controllers.
- The following patches for Windows Server 2008 are required:
    - <http://support.microsoft.com/kb/958124>

This patch fixes a memory leak in Microsoft's WMI, which prevents ISE to establish successful connection with the domain controller.

- <http://support.microsoft.com/kb/973995>

This patch fixes different memory leak in Microsoft's WMI, which sporadically prevents the Active Directory domain controller from writing the necessary user login events to the Security Log of the domain controller.

- The following patches for Windows Server 2008 R2 are required (unless SP1 is installed):

- <http://support.microsoft.com/kb/981314>

This patch fixes memory leak in Microsoft's WMI, which sporadically prevents the Active Directory domain controller from writing the necessary user login events to the Security Log of the domain controller.

- <http://support.microsoft.com/kb/2617858>

This patch fixes unexpectedly slow startup or logon process in Windows Server 2008 R2.

- The patches listed at the following link, for WMI related issues on Windows platform are required:

- <http://support.microsoft.com/kb/2591403>

These hot fixes are associated with the operation and functionality of the WMI service and its related components.

**Step 2** Make sure the Active Directory logs the user login events in the Windows Security Log.

Verify that the Audit Policy settings (part of the Group Policy Management settings) allows successful logons to generate the necessary events in the Windows Security Log (this is the default Windows setting, but you must explicitly ensure that this setting is correct).

**Step 3** You must have an Active Directory user with sufficient permissions for ISE to connect to the Active Directory. The following instructions show how to define permissions either for admin domain group user or none admin domain group user:

- Permissions Required when an Active Directory User is a Member of the Domain Admin Group
- Permissions Required when an Active Directory User is Not a Member of the Domain Admin Group

**Step 4** The Active Directory user used by ISE can be authenticated either by NT Lan Manager (NTLM) v1 or v2. You need to verify that the Active Directory NTLM settings are aligned with ISE NTLM settings to ensure successful authenticated connection between ISE and the Active Directory Domain Controller. The following table shows all Microsoft NTLM options, and which ISE NTLM actions are supported. If ISE is set to NTLMv2, all six options described in are supported. If ISE is set to support NTLMv1, only the first five options are supported.

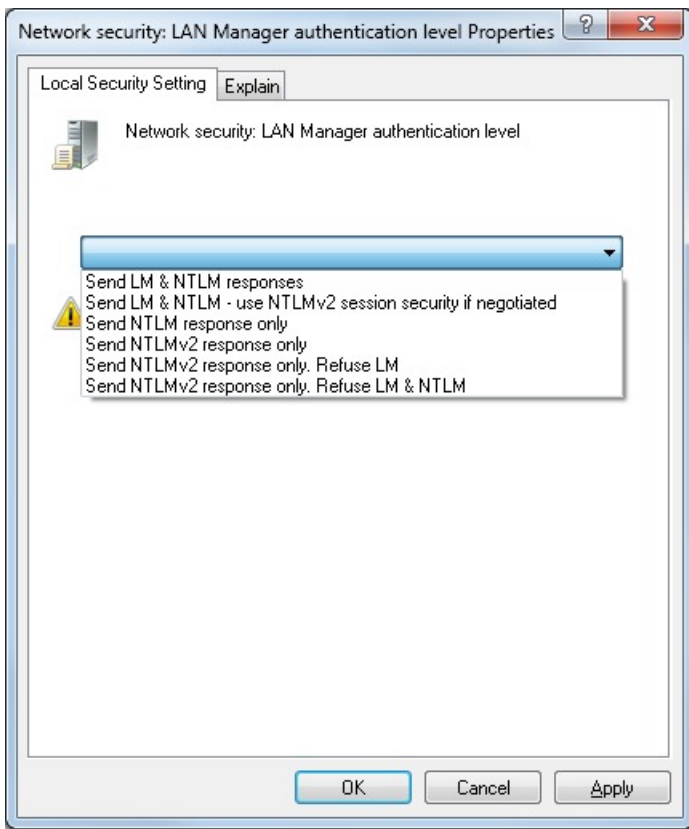
**Table 18: Supported Authentication Types Based on ISE and AD NTLM Version Settings**

| ISE NTLM Setting Options / Active Directory (AD) NTLM Setting Options<br>NTLMv1 NTLMv2 | NTLMv1                | NTLMv2                |
|----------------------------------------------------------------------------------------|-----------------------|-----------------------|
| Send LM & NTLM responses<br>connection is allowed connection is allowed                | Connection is allowed | Connection is allowed |



| ISE NTLM Setting Options / Active Directory (AD) NTLM Setting Options<br>NTLMv1 NTLMv2                    | NTLMv1                | NTLMv2                |
|-----------------------------------------------------------------------------------------------------------|-----------------------|-----------------------|
| Send LM & NTLM - use NTLMv2 session security if negotiated<br>connection is allowed connection is allowed | Connection is allowed | Connection is allowed |
| Send NTLM response only connection is allowed connection is allowed                                       | Connection is allowed | Connection is allowed |
| Send NTLMv2 response only connection is allowed connection is allowed                                     | Connection is allowed | Connection is allowed |
| Send NTLMv2 response only. Refuse LM connection is allowed connection is allowed                          | Connection is allowed | Connection is allowed |
| Send NTLMv2 response only. Refuse LM & NTLM connection is refused connection is allowed                   | Connection is refused | Connection is allowed |

Figure 30: MS NTLM Authentication Type Options



**Step 5** Make sure that you have created a firewall rule to allow traffic to `dllhost.exe` on Active Directory domain controllers. You can either turn the firewall off, or allow access on a specific IP (ISE IP address) to the following ports:

- TCP 135: General RPC Port. When doing asynchronous RPC calls, the service listening on this port tells the client which port the component servicing this request is using.
- UDP 137: Netbios Name Resolution
- UDP 138: Netbios Datagram Service
- TCP 139: Netbios Session Service
- TCP 445: SMB

Higher ports are assigned dynamically or you can configure them manually. We recommend that you add `%SystemRoot%\System32\dllhost.exe` as a target. This program manages ports dynamically.

All firewall rules can be assigned to specific IP (ISE IP).

## Set the Windows Audit Policy

Ensure that the **Audit Policy** (part of the **Group Policy Management** settings) allows successful logons. This is required to generate the necessary events in the Windows Security Log of the AD domain controller machine. This is the default Windows setting, but you must verify that this setting is correct.

**Step 1** Choose **Start > Programs > Administrative Tools > Group Policy Management**.

**Step 2** Navigate under Domains to the relevant domain and expand the navigation tree.

**Step 3** Choose **Default Domain Controller Policy**, right click and choose **Edit**.

The Group Policy Management Editor appears.

**Step 4** Choose **Default Domain Controllers Policy > Computer Configuration > Policies > Windows Settings > Security Settings**.

- For Windows Server 2003 or Windows Server 2008 (non-R2), choose **Local Policies > Audit Policy**. For the two Policy items, **Audit Account Logon Events** and **Audit Logon Events**, ensure that the corresponding **Policy Setting** either directly or indirectly includes the **Success** condition. To include the Success condition indirectly, the **Policy Setting** must be set to **Not Defined**, indicating that the effective value will be inherited from a higher level domain, and the **Policy Setting** for that higher level domain must be configured to explicitly include the **Success** condition.
- For Windows Server 2008 R2 and Windows 2012, choose **Advanced Audit Policy Configuration > Audit Policies > Account Logon**. For the two Policy items, **Audit Kerberos Authentication Service** and **Audit Kerberos Service Ticket Operations**, ensure that the corresponding Policy Setting either directly or indirectly includes the Success condition, as described above.

**Step 5** If any Audit Policy item settings have been changed, you should then run `gpupdate /force` to force the new settings to take effect.

## Set Permissions when Microsoft Active Directory Users are in Domain Admin Group

For Windows Server 2008 R2, Windows Server 2012, and Windows Server 2012 R2, the Domain Admin group does not have full control of certain registry keys in the Windows operating system by default. The Microsoft Active Directory administrator must give the Microsoft Active Directory user full control permissions on the following registry keys:

- **HKEY\_CLASSES\_ROOT\CLSID\{76A64158-CB41-11D1-8B02-00600806D9B6}**
- **HKLM\Software\Classes\Wow6432Node\CLSID\{76A64158-CB41-11D1-8B02-00600806D9B6}**

The following Microsoft Active Directory versions require no registry changes:

- Windows 2003
- Windows 2003R2
- Windows 2008

To grant full control, the Microsoft Active Directory admin must first take ownership of the key:

---

**Step 1** Right-click the key icon and choose the **Owner** tab.

**Step 2** Click **Permissions**.

**Step 3** Click **Advanced**.

---

## Permissions for Microsoft Active Directory Users Not in Domain Admin Group

For Windows Server 2012 R2, give the Microsoft AD user full control permissions on the following registry keys:

- **HKEY\_CLASSES\_ROOT\CLSID\{76A64158-CB41-11D1-8B02-00600806D9B6}**
- **HKLM\Software\Classes\Wow6432Node\CLSID\{76A64158-CB41-11D1-8B02-00600806D9B6}**

Use the following commands in Windows PowerShell to check if full permission is given to the registry keys:

- ```
get-acl -path "Microsoft.PowerShell.Core\Registry::HKEY_CLASSES_ROOT\CLSID\{76A64158-CB41-11D1-8B02-00600806D9B6}" | format-list
```
- ```
get-acl -path "hklm:\Software\Classes\Wow6432Node\CLSID\{76A64158-CB41-11D1-8B02-00600806D9B6}" | format-list
```

The following permissions are required when a Microsoft AD user is not in the Domain Admin group, but is in the Domain Users group:

- Add registry keys to allow Cisco ISE to connect to the domain controller.
- [Permissions to Use DCOM on the Domain Controller, on page 256](#)

- [Set Permissions for Access to WMI Root and CIMv2 Namespace, on page 258](#)

These permissions are only required for the following Microsoft AD versions:

- Windows 2003
- Windows 2003R2
- Windows 2008
- Windows 2008 R2
- Windows 2012
- Windows 2012 R2
- Windows 2016

### Add Registry Keys to Allow Cisco ISE to Connect to the Domain Controller

You must manually add some registry keys to the domain controller to allow Cisco ISE to connect as a domain user, and retrieve login authentication events. An agent is not required on the domain controllers or on any machines in the domain.

The following registry script shows the keys to add. You can copy and paste this into a text file, save the file with a .reg extension, and double click the file to make the registry changes. To add registry keys, the user must be an owner of the root key.

```
Windows Registry Editor Version 5.00

[HKEY_CLASSES_ROOT\CLSID\{76A64158-CB41-11D1-8B02-00600806D9B6}]
"AppID"="{76A64158-CB41-11D1-8B02-00600806D9B6}"

[HKEY_CLASSES_ROOT\AppID\{76A64158-CB41-11D1-8B02-00600806D9B6}]
"DllSurrogate"=" "

[HKEY_CLASSES_ROOT\Wow6432Node\AppID\{76A64158-CB41-11D1-8B02-00600806D9B6}]
"DllSurrogate"=" "
```

Make sure that you include two spaces in the value of the DllSurrogate key. If the registry is manually updated, you must include only the two spaces and do not include the quotes. While updating the registry manually, ensure that quotes are not included for AppID, DllSurrogate, and its values.

Retain the empty lines as shown in the preceding script, including the empty line at the end of the file.

Use the following commands in the Windows command prompt to confirm if the registry keys are created and have the correct values:

- `reg query "HKEY_CLASSES_ROOT\CLSID\{76A64158-CB41-11D1-8B02-00600806D9B6}" /f "{76A64158-CB41-11D1-8B02-00600806D9B6}" /e`
- `reg query HKEY_CLASSES_ROOT\AppID\{76A64158-CB41-11D1-8B02-00600806D9B6} /f " " /e`
- `reg query HKEY_CLASSES_ROOT\Wow6432Node\AppID\{76A64158-CB41-11D1-8B02-00600806D9B6} /f " " /e`

## Permissions to Use DCOM on the Domain Controller

The Microsoft Active Directory user who is used for Cisco ISE Passive Identity service must have the permissions to use DCOM on the domain controller server. Configure permissions with the `dcomcnfg` command line tool.

- Step 1** Run the `dcomcnfg` tool from the command line.
- Step 2** Expand **Component Services**.
- Step 3** Expand **Computers > My Computer**.
- Step 4** Choose **Action** from the menu bar, click **Properties**, and click **COM Security**.
- Step 5** The account that Cisco ISE uses for both access and launch must have Allow permissions. Add the Microsoft Active Directory user to all the four options, **Edit Limits** and **Edit Default** for both **Access Permissions** and **Launch and Activation Permissions**.
- Step 6** Allow all local and remote accesses for both **Access Permissions** and **Launch and Activation Permissions**.

*Figure 31: Local and Remote Accesses for Access Permissions*

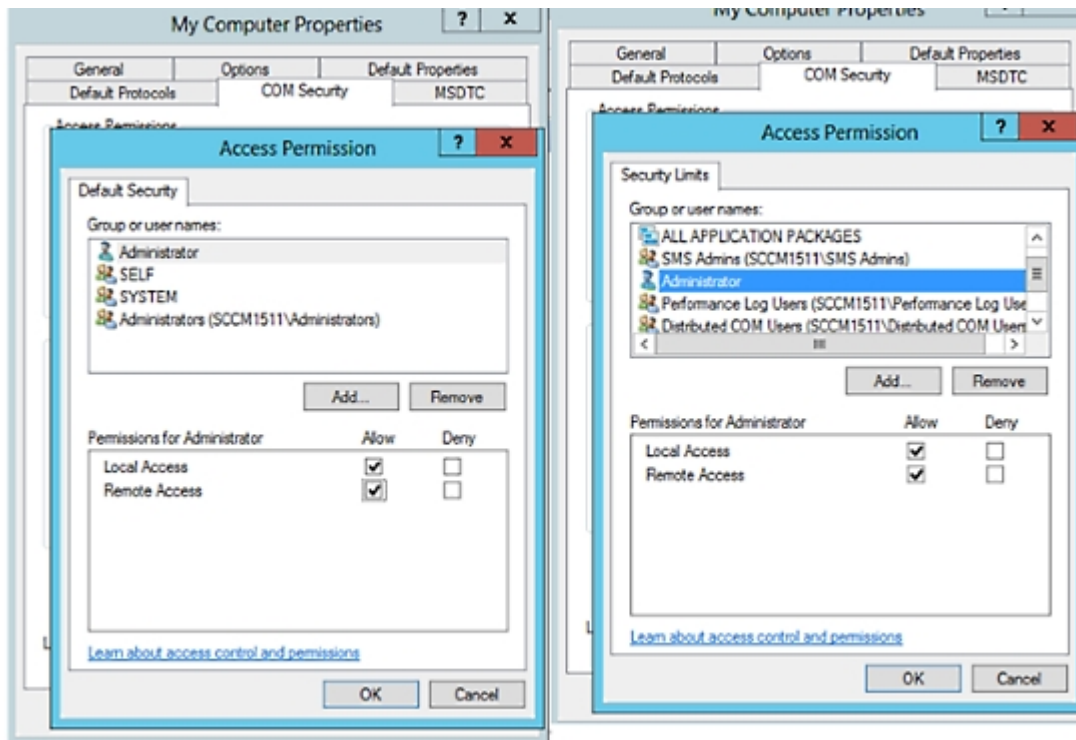
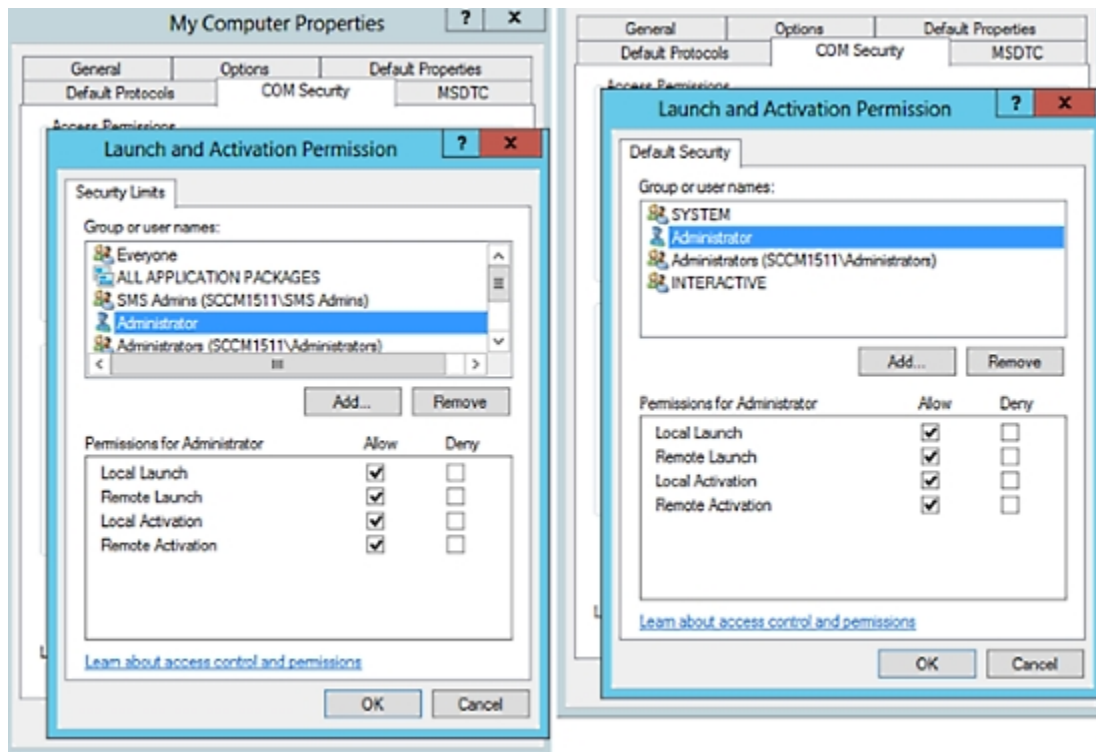


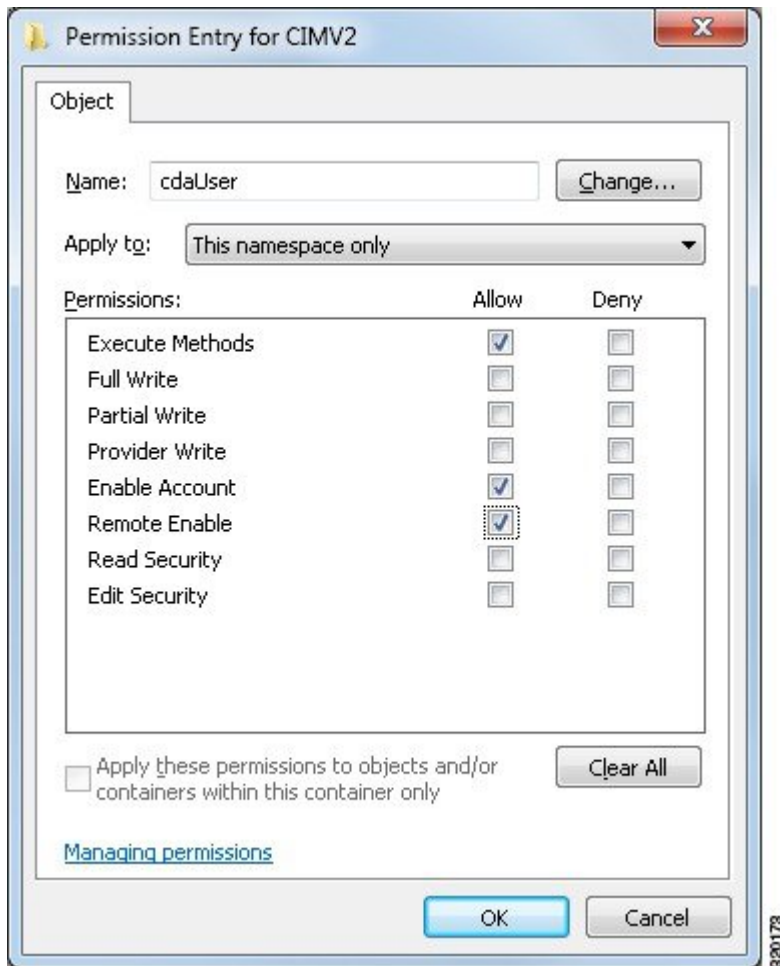
Figure 32: Local and Remote Accesses for Launch and Activation Permissions



## Set Permissions for Access to WMI Root and CIMv2 Namespace

By default, Microsoft Active Directory users do not have permissions for the Execute Methods and Remote Enable. You can grant access using the `wmimgmt.msc` MMC console.

- Step 1** Choose **Start** > **Run** and enter `wmimgmt.msc`.
- Step 2** Right-click **WMI Control** and click **Properties**.
- Step 3** Under the **Security** tab, expand **Root** and choose **CIMV2**.
- Step 4** Click **Security**.
- Step 5** Add the Microsoft Active Directory user, and configure the required permissions as shown in the following image.



## Grant Access to the Security Event Log in the AD Domain Controller

On Windows 2008 and later, you can grant access to the AD Domain controller logs by adding the ISE ID Mapping user to a group called Event Log Readers.

On all older versions of Windows, you must edit a registry key, as shown below.

**Step 1** To delegate access to the Security event logs, find the SID for the account .

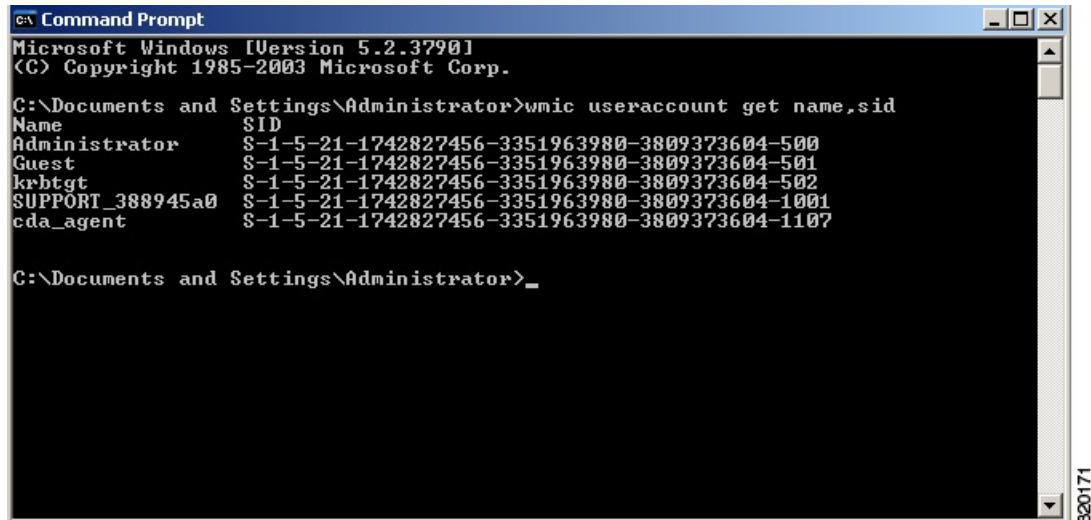
**Step 2** Use the following command from the command line, also shown in the diagram below, to list all the SID accounts.

```
wmic useraccount get name,sid
```

You can also use the following command for a specific username and domain:

```
wmic useraccount where name="iseUser" get domain,name,sid
```

Figure 33: List All the SID Accounts



```

c:\ Command Prompt
Microsoft Windows [Version 5.2.3790]
(C) Copyright 1985-2003 Microsoft Corp.

C:\Documents and Settings\Administrator>wmic useraccount get name,sid
Name SID
Administrator S-1-5-21-1742827456-3351963980-3809373604-500
Guest S-1-5-21-1742827456-3351963980-3809373604-501
krbtgt S-1-5-21-1742827456-3351963980-3809373604-502
SUPPORT_388945a0 S-1-5-21-1742827456-3351963980-3809373604-1001
cda_agent S-1-5-21-1742827456-3351963980-3809373604-1107

C:\Documents and Settings\Administrator>_

```

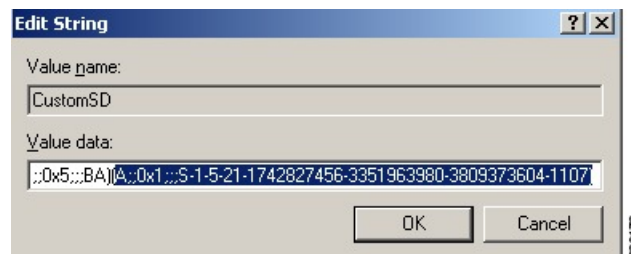
**Step 3** Find the SID, open the Registry Editor, and browse to the following location:

HKEY\_LOCAL\_MACHINE/SYSTEM/CurrentControlSet/Services/Eventlog

**Step 4** Click on **Security**, and double click **CustomSD**.

For example, to allow read access to the ise\_agent account (SID - S-1-5-21-1742827456-3351963980-3809373604-1107), enter (A;;0x1;;;S-1-5-21-1742827456-3351963980-3809373604-1107).

Figure 34: Edit CustomSD String



**Step 5** Restart the WMI service on the Domain Controller. You can restart the WMI services in the following two ways:

a) Run the following commands from the CLI:

```
net stop winmgmt
```

```
net start winmgmt
```

b) Run `Services.msc`, which opens the Windows Services Management tool. In the Windows Services Management window, locate the **Windows Management Instrumentation** service, right click, and select **Restart**.



# Easy Connect

Easy Connect enables you to easily connect users from a wired endpoint to a network in a secure manner and monitor those users by authenticating them through an Active Directory Domain Controller and not by Cisco ISE. With Easy Connect, Cisco ISE collects user authentication information from the Active Directory Domain Controller. Easy Connect connects to a Windows system (Active Directory) using the MS WMI interface and queries logs from the Windows event messaging, hence it currently only supports Windows-installed endpoints. Easy Connect supports wired connections using MAB, which is much easier to configure than 802.1X. Unlike 802.1X, with Easy Connect and MAB:

- You don't need to configure supplicants
- You don't need to configure PKI
- ISE issues a CoA after the external server (AD) authenticates the user

Easy Connect supports these modes of operation:

- Enforcement-mode: ISE actively downloads the authorization policy to the network device for enforcement based on the user credentials.
- Visibility-mode: Cisco ISE publishes session merge and accounting information received from the NAD device sensor in order to send that information to pxGrid.

In both cases, users authenticated with Active Directory (AD) are shown in the Cisco ISE live sessions view, and can be queried from the session directory using Cisco pxGrid interface by third-party applications. The known information is the user name, IP address, the AD DC host name, and the AD DC NetBios name. For more information about pxGrid, see [Cisco pxGrid Node, on page 63](#).

Once you have set up Easy Connect, you can then filter certain users, based on their name or IP address. For example, if you have an administrator from IT services who logs in to an endpoint in order to assist the regular user with that endpoint, you can filter out the administrator activity so it does not appear in Live Sessions, but rather only the regular user of that endpoint will appear. To filter passive identity services, see [Filter Passive Identity Services, on page 403](#).

## Easy Connect Restrictions

- MAC Authentication Bypass (MAB) supports Easy Connect. Both MAB and 802.1X can be configured on the same port, but you must have a different ISE policy for each service.
- Only MAB connections are currently supported. You do not need a unique authentication policy for connections, because the connection is authorized and permissions are granted by an Easy Connect condition defined in the authorization policy.
- Easy Connect is supported in High Availability mode. Multiple nodes can be defined and enabled with a Passive ID. ISE then automatically activates one PSN, while the other nodes remain in standby.
- Only Cisco Network Access Devices (NADs) are supported.
- IPv6 is not supported.
- Wireless connections are not currently supported.
- Only Kerberos auth events are tracked and therefore Easy Connect enables only user authentication and does not support machine authentication.

Easy Connect requires configuration in ISE, while the Active Directory Domain server must also have the correct patches and configuration based on instructions and guidelines issued by Microsoft. For information about configuring the Active Directory domain controller for Cisco ISE, see [Active Directory Requirements to Support Easy Connect and Passive Identity services, on page 347](#)

### Easy Connect Enforcement Mode

Easy Connect enables users to log on to a secure network from a wired endpoint (usually a PC) with a Windows operating system, by using MAC address bypass (MAB) protocol, and accessing Active Directory (AD) for authentication. Easy Connect listens for a Windows Management Instrumentation (WMI) event from the Active Directory server for information about authenticated users. When AD authenticates a user, the Domain Controller generates an event log that includes the user name and IP address allocated for the user. Cisco ISE receives notification of log in from AD, and then issues a RADIUS Change of Authorization (CoA).



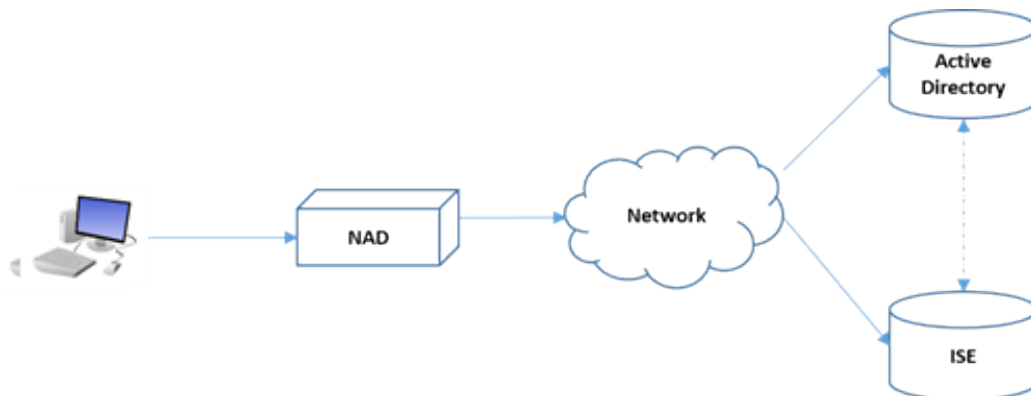
**Note** MAC address lookup is not done for a MAB request when the Radius service-type is set to call-check. Therefore the return to the request is access-accept. This is the default configuration.

### Easy Connect Enforcement Mode Process Flow

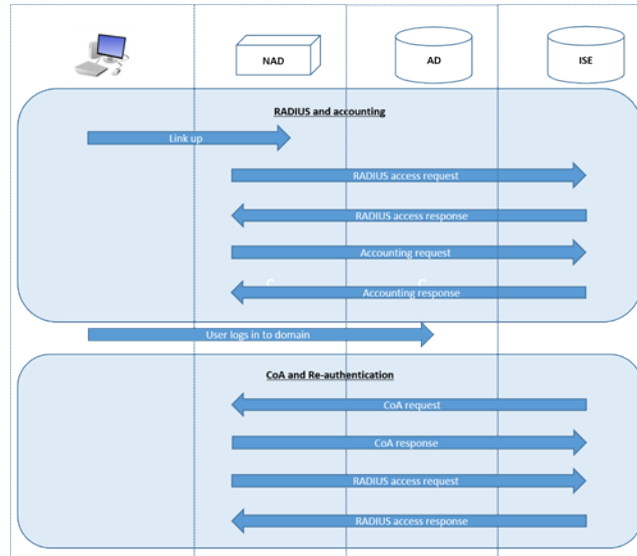
The Easy Connect Enforcement mode process is as follows:

1. The user connects to the NAD from a wired endpoint (such as a PC for example).
2. The NAD (which is configured for MAB) sends an access request to Cisco ISE. Cisco ISE responds with access, based on user configuration, allowing the user to access AD. Configuration must allow at least access to DNS, DHCP, and AD.
3. The user logs in to the domain and a security audit event is sent to Cisco ISE.
4. ISE collects the MAC address from RADIUS and the IP address and domain name, as well as accounting information (login information) about the user, from the security audit event.
5. After all data is collected and merged in the session directory, Cisco ISE issues a CoA to the NAD (based on the appropriate policy managed in the policy service node), and the user is provided access by the NAD to the network based on that policy.

**Figure 35: Easy Connect Enforcement Mode Basic Flow**



**Figure 36: Easy Connect Enforcement Mode Detailed Flow**

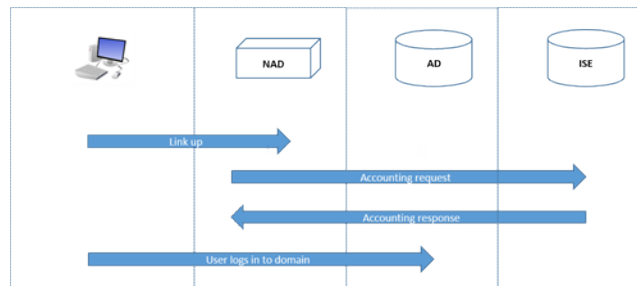


For more information about configuring Enforcement mode, see [Configure Easy Connect Enforcement Mode, on page 359](#).

**Easy Connect Visibility Mode**

With the Visibility mode, Cisco ISE only monitors accounting information from RADIUS (part of the device sensor feature in the NAD) and does not perform authorization. Easy Connect listens for RADIUS Accounting and WMI events, and publishes that information to logs and reports, (and optionally, to pxGrid). Both RADIUS accounting start and session termination are published to pxGrid during user login using Active Directory when pxGrid is setup.

**Figure 37: Easy Connect Visibility Mode Flow**



For more information about configuring Easy Connect Visibility mode, see [Configure Easy Connect Visibility Mode, on page 360](#).

**Configure Easy Connect Enforcement Mode**

**Before you begin**

- For best performance, deploy a dedicated PSN to receive WMI events.

- Create a list of Active Directory Domain Controllers for the WMI node, which receives AD login events.
- Determine the Microsoft Domain that Cisco ISE must join to fetch user groups from Active Directory.
- Determine the Active Directory groups that are used as a reference in the authorization policy.
- If you are using pxGrid to share session data from network devices with other pxGrid-enabled systems, then define a pxGrid persona in your deployment. For more information about pxGrid, see [Cisco pxGrid Node, on page 63](#)
- After successful MAB, the NAD must provide a limited-access profile, which allows the user on that port access to the Active Directory server.



**Note** Passive Identity Service can be enabled on multiple nodes, but Easy Connect can only operate on one node at a time. If you enable the service for multiple nodes, ISE will automatically determine which node to use for the active Easy Connect session.

- 
- Step 1** Choose **Administration > System > Deployment**, open a node, and under **General Settings**, enable **Enable Passive Identity Service**.
- Step 2** Configure an Active Directory join point and domain controller to be used by Easy Connect. For more information, see [Active Directory Requirements to Support Easy Connect and Passive Identity services, on page 347](#).
- Step 3** (Optional) Choose **Administration > Identity Management > External Identity Sources > Active Directory**. Click the **Groups** tab, and add the Active Directory groups you plan to use in your authorization policies. The Active Directory groups that you map for the Domain Controller are dynamically updated in the PassiveID dictionary and can then be used when you set up your policy conditions rules.
- Step 4** **Note** **Passive Identity Tracking** must be enabled for all profiles used for Easy Connect authorization in order for the Easy Connect process to run properly and enable ISE to issue a CoA.
- Choose **Policy > Policy Elements > Results > Authorization > Authorization Profiles**. For any profiles to be used by Easy Connect, open the profile and enable **Passive Identify Tracking**.
- Step 5** Choose **Policy > Policy Elements > Conditions > Authorization > Simple Conditions**, to create rules for Easy Connect. Click **Add** and define the condition:
- Enter a name and description.
  - From **Attribute**, go to the PassiveID dictionary and select either `PassiveID_Groups` to create a condition for domain controller groups, or select `PassiveID_user` to create a condition for individual users.
  - Enter the correct operation.
  - Enter the user name or group name to be included in the policy.
- Step 6** Click **Submit**.
- 

## Configure Easy Connect Visibility Mode

### Before you begin

- For best performance, deploy a dedicated PSN to receive WMI events.

- Create a list of Active Directory Domain Controllers for the WMI node, which receives AD login events.
- Determine the Microsoft Domain that Cisco ISE must join to fetch user groups from Active Directory.
- If you are using pxGrid to share session data from network devices with other pxGrid-enabled systems, then define a pxGrid persona in your deployment. For more information about pxGrid, see [Cisco pxGrid Node, on page 63](#)

- 
- Step 1** Choose **Administration > System > Deployment**, open a node, and under **General Settings**, enable **Enable Passive Identity Service**.
- Step 2** Configure an Active Directory join point and domain controller to be used by Easy Connect. For more information, see [Active Directory Requirements to Support Easy Connect and Passive Identity services, on page 347](#).
- 

## PassiveID Work Center

Passive Identity Connector (the PassiveID work center) offers a centralized, one-stop installation and implementation enabling you to easily and simply configure your network in order to receive and share user identity information with a variety of different security product subscribers such as Cisco Firepower Management Center (FMC) and Stealthwatch. As the full broker for passive identification, the PassiveID work center collects user identities from different provider sources, such as Active Directory Domain Controllers (AD DC), maps the user login information to the relevant IP addresses in use and then shares that mapping information with any of the subscriber security products that you have configured.

### What is Passive Identity?

Standard flows offered by Cisco Identity Services Engine (ISE), which provide an authentication, authorization and accounting (AAA) server, and utilize technologies such as 802.1X or Web Authentication, communicate directly with the user or endpoint, requesting access to the network, and then using their login credentials in order to verify and actively authenticate their identity.

Passive identity services do not authenticate users directly, but rather gather user identities and IP addresses from external authentication servers such as Active Directory, known as providers, and then share that information with subscribers. the PassiveID work center first receives the user identity information from the provider, usually based on the user login and password, and then performs the necessary checks and services in order to match the user identity with the relevant IP address, thereby delivering the authenticated IP address to the subscriber.

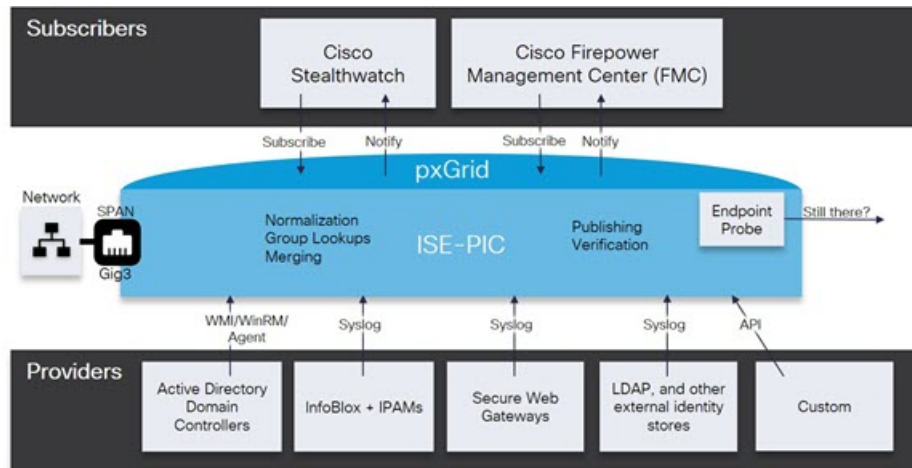
### Passive Identity Connector (PassiveID work center) Flow

The flow for the PassiveID work center is as follows:

1. Provider performs the authentication of the user or endpoint.
2. Provider sends authenticated user information to Cisco ISE.
3. Cisco ISE normalizes, performs lookups, merges, parses and maps user information to IP addresses and publishes mapped details to pxGrid.
4. pxGrid subscribers receive the mapped user details.

The following diagram illustrates the high-level flow offered by Cisco ISE.

**Figure 38: High Level Flow**



## Initial Setup and Configuration

To get started using Cisco PassiveID work center quickly, follow this flow:

1. Ensure you have properly configured the DNS server, including configuring reverse lookup for the client machine from Cisco ISE. For more information, see [DNS Server, on page 328](#).
2. Enable the Passive Identity and pxGrid services on the dedicated Policy server (PSN) you intend to use for any of the Passive Identity services. Choose **Administration > System > Deployment**, open the relevant node, and under **General Settings**, enable **Enable Passive Identity Service** and **pxGrid**.
3. Synchronize clock settings for the NTP servers.
4. Configure an initial provider with the ISE Passive Identity Setup. For more information, see [Getting Started with the PassiveID Setup, on page 364](#)
5. Configure a single or multiple subscribers. For more information, see [Subscribers, on page 406](#)

After setting up an initial provider and subscriber, you can easily create additional providers (see [Additional Passive Identity Service Providers, on page 369](#)) and manage your passive identification from the different providers in the PassiveID work center.

## PassiveID Work Center Dashboard

The Cisco PassiveID Work Center dashboard displays consolidated and correlated summary and statistical data that is essential for effective monitoring and troubleshooting, and is updated in real time. Dashlets show activity over the last 24 hours, unless otherwise noted. To access the dashboard, choose **Work Centers > PassiveID** and then from the left panel choose **Dashboard**. You can only view the Cisco PassiveID Work Center Dashboard in the Primary Administration Node (PAN).

- The **Main** view has a linear Metrics dashboard, chart dashlets, and list dashlets. In the PassiveID Work Center, the dashlets are not configurable. Available dashlets include:

- **Passive Identity Metrics:** Displays the total number of unique live sessions currently being tracked, the total number of identity providers configured in the system, the total number of agents actively delivering identity data, and the total number of subscribers currently configured.
- **Providers:** Providers provide user identity information to PassiveID Work Center. You configure the ISE probe (mechanisms that collect data from a given source) through which to receive information from the provider sources. For example, an Active Directory (AD) probe and an Agents probe both help ISE-PIC collect data from AD (each with different technology) while a Syslog probe collects data from a parser that reads syslog messages.
- **Subscribers:** Subscribers connect to ISE to retrieve user identity information.
- **OS Types:** The only OS type that can be displayed is Windows. Windows types display by Windows versions. Providers do not report the OS type, but ISE can query Active Directory to get that information. Up to 1000 entries are displayed in the dashlet.
- **Alarms:** User identity-related alarms.

## Active Directory as a Probe and a Provider

Active Directory (AD) is a highly secure and precise source from which to receive user identity information, including user name, IP address, and domain name.

The AD probe, a Passive Identity service, collects user identity information from AD through WMI technology, while other probes use AD as a user identity provider through other technologies and methods. For more information about other probes and provider types offered by ISE, see [Additional Passive Identity Service Providers, on page 369](#).

By configuring the Active Directory probe you can also then quickly configure and enable these other probes (which also use Active Directory as their source):

- [Active Directory Agents, on page 371](#)



---

**Note** The Active Directory agents are only supported on Windows Server 2008 and higher.

---

- [SPAN, on page 380](#)
- [Endpoint Probe, on page 404](#)

In addition, configure the Active Directory probe in order to use AD user groups when collecting user information. You can use AD user groups for the AD, Agents, SPAN, and Syslog probes. For more information about AD groups, see [Configure Active Directory User Groups, on page 334](#).

### Set Up an Active Directory (WMI) Probe

To configure Active Directory and WMI for Passive Identity service you can use the Passive ID Work Center Wizard (see [Getting Started with the PassiveID Setup, on page 364](#)) or you can follow the steps as follows:

1. Configure the Active Directory probe. See [Add an Active Directory Join Point and Join Cisco ISE Node to the Join Point, on page 329](#).

2. Create a list of Active Directory Domain Controllers for the WMI-configured node (or nodes) that receives AD login events. See [#unique\\_537](#).
3. Configure the Active Directory in order for it to integrate with ISE. See [#unique\\_538](#).
4. (Optional) [Manage the Active Directory Provider, on page 366](#).

For more information, see [Active Directory Requirements to Support Easy Connect and Passive Identity services, on page 347](#).

## Getting Started with the PassiveID Setup

ISE-PIC offers a wizard from which you can easily and quickly configure Active Directory as your first user identity provider, in order to receive user identities from Active Directory. By configuring Active Directory for ISE-PIC, you also simplify the process for configuring other provider types later on. Once you have configured Active Directory, you must then configure a Subscriber (such as Cisco Firepower Management Center (FMC) or Stealthwatch), in order to define the client that is to receive the user data. For more information about subscribers, see [Subscribers, on page 406](#).

### Before you begin

- Ensure the Microsoft Active Directory server does not reside behind a network address translator and does not have a Network Address Translation (NAT) address.
- Ensure the Microsoft Active Directory account intended for the join operation is valid and is not configured with the Change Password on Next Login.
- Ensure you have the privileges of a Super Admin or System Admin in ISE.
- Enable the Passive Identity and pxGrid services on the dedicated Policy server (PSN) you intend to use for any of the Passive Identity services. Choose **Administration > System > Deployment**, open the relevant node, and under **General Settings**, enable **Enable Passive Identity Service** and **pxGrid**.
- Ensure that ISE has an entry in the domain name server (DNS). Ensure you have properly configured reverse lookup for the client machine from ISE. For more information, see [DNS Server, on page 328](#)

---

**Step 1** Choose **Work Centers > PassiveID**. From the Passive Identity Connector Overview screen, click **Passive Identity Wizard**.

The PassiveID Setup window appears.

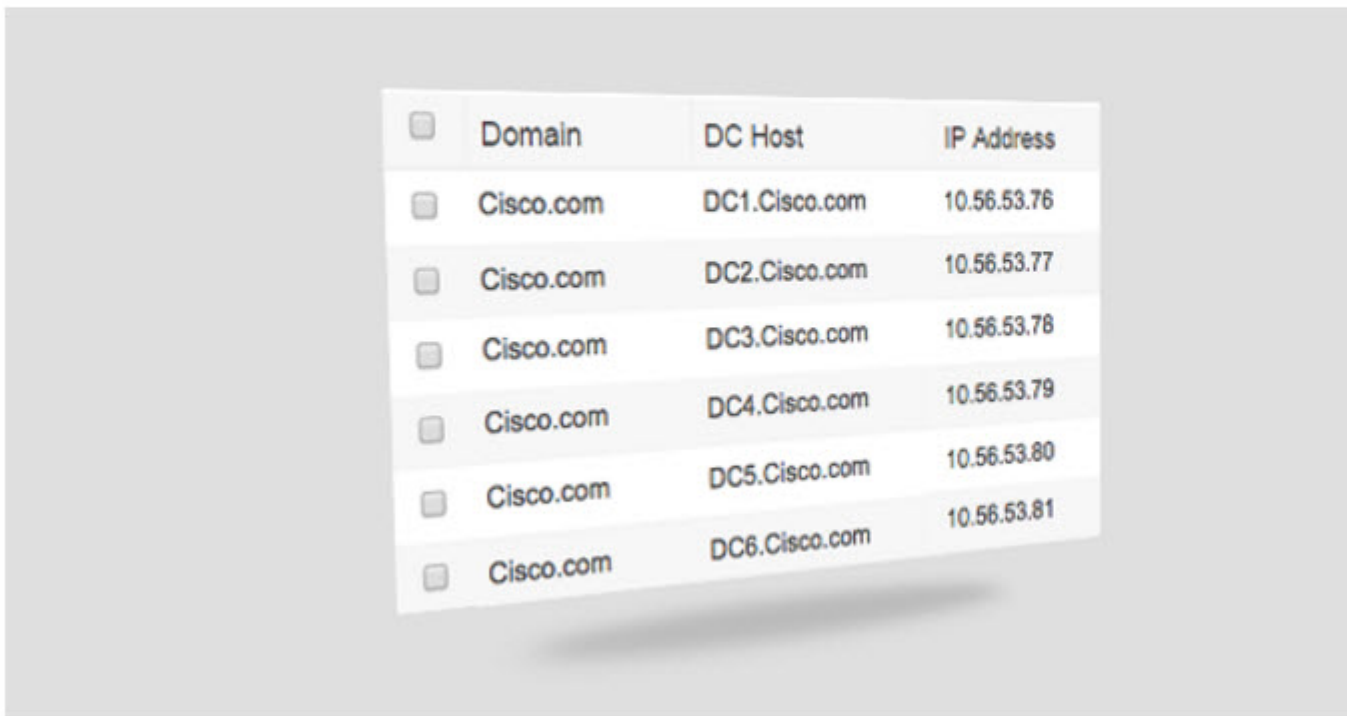


Figure 39: The PassiveID Setup

## PassiveID Setup

[Home](#)
 [Welcome](#)
 [1 Active Directory](#)
 [2 Groups](#)
 [3 Domain Controllers](#)
 [4 Custom selection](#)
 [5 Summary](#)

This wizard will setup passive identity using Active Directory.  
 If you prefer to use Syslogs, SPAN or API providers, then exit wizard and Identity Providers of all types may be added at a later date.



**Step 2** Click **Next** to begin the wizard.

**Step 3** Enter a unique name for this Active Directory join point. Enter the domain name for the Active Directory Domain to which this node is connected, and enter your Active Directory administrator user name and password.

It is strongly recommended that you choose **Store credentials**, in which case your administrator's user name and password will be saved in order to be used for all Domain Controllers (DC) that are configured for monitoring.

**Step 4** Click **Next** to define Active Directory groups and check any user groups to be included and monitored. The Active Directory user groups automatically appear based on the Active Directory join point you configured in the previous step.

- Step 5** Click **Next**. Select the DCs to be monitored. If you choose Custom, then from the next screen select the specific DCs for monitoring. When finished, click **Next**.
- Step 6** Click **Exit** to complete the wizard.

### What to do next

When you finish configuring Active Directory as your initial provider, you can easily configure additional provider types as well. For more information, see [Additional Passive Identity Service Providers, on page 369](#). Furthermore, you can now also configure a subscriber, designated to receive the user identity information that is collected by any of the providers you have defined. For more information, see [Subscribers, on page 406](#).

## Manage the Active Directory Provider

Once you have created and configured your Active Directory join points, continue to manage the Active Directory probe with these tasks:

- [Test Users for Active Directory Authentication, on page 341](#)
- [View Active Directory Joins for a Node, on page 342](#)
- [Diagnose Active Directory Problems, on page 342](#)
- [Leave the Active Directory Domain, on page 333](#)
- [Delete Active Directory Configurations, on page 341](#)
- [Enable Active Directory Debug Logs, on page 343](#)

## Active Directory Settings

Active Directory (AD) is a highly secure and precise source from which to receive user information, including user name and IP address.

To create and manage Active Directory probes by creating and editing join points, choose **Work Centers > PassiveID > Providers > Active Directory**.

For more information, see [Add an Active Directory Join Point and Join Cisco ISE Node to the Join Point, on page 329](#).

*Table 19: Active Directory Join Point Name Settings and Join Domain Window*

| Field Name                     | Description                                                                                                           |
|--------------------------------|-----------------------------------------------------------------------------------------------------------------------|
| <b>Join Point Name</b>         | A unique name that distinguishes this configured join point quickly and easily.                                       |
| <b>Active Directory Domain</b> | The domain name for the Active Directory Domain to which this node is connected.                                      |
| <b>Domain Administrator</b>    | This is the user principal name or the user account name for the Active Directory user with administrator privileges. |

| Field Name                         | Description                                                                                                                                                                                                                                                                                                     |
|------------------------------------|-----------------------------------------------------------------------------------------------------------------------------------------------------------------------------------------------------------------------------------------------------------------------------------------------------------------|
| <b>Password</b>                    | This is the domain administrator's password as configured in Active Directory.                                                                                                                                                                                                                                  |
| <b>Specify Organizational Unit</b> | Enter the administrator's organizational unit information                                                                                                                                                                                                                                                       |
| <b>Store Credentials</b>           | It is strongly recommended that you choose <b>Store credentials</b> , in which case your administrator's user name and password will be saved in order to be used for all Domain Controllers (DC) that are configured for monitoring.<br><br>For the Endpoint probe, you must choose <b>Store credentials</b> . |

Table 20: Active Directory Join/Leave Window

| Field Name               | Description                                                                                                                                                                                  |
|--------------------------|----------------------------------------------------------------------------------------------------------------------------------------------------------------------------------------------|
| <b>ISE Node</b>          | The URL for the specific node in the installation.                                                                                                                                           |
| <b>ISE Node Role</b>     | Indicates whether the node is the Primary or Secondary node in the installation.                                                                                                             |
| <b>Status</b>            | Indicates whether the node is actively joined to the Active Directory domain.                                                                                                                |
| <b>Domain Controller</b> | For nodes that are joined to Active Directory, this column indicates the specific Domain Controller to which the node is connected in the Active Directory Domain.                           |
| <b>Site</b>              | When an Active Directory forest is joined with ISE, this field indicates the specific Active Directory site within the forest as it appears in the Active Directory Sites and Services area. |

Table 21: Passive ID Domain Controllers (DC) List

| Field             | Description                                                                                                                                                                                  |
|-------------------|----------------------------------------------------------------------------------------------------------------------------------------------------------------------------------------------|
| <b>Domain</b>     | The fully qualified domain name of the server on which the domain controller is located.                                                                                                     |
| <b>DC Host</b>    | The host on which the domain controller is located.                                                                                                                                          |
| <b>Site</b>       | When an Active Directory forest is joined with ISE, this field indicates the specific Active Directory site within the forest as it appears in the Active Directory Sites and Services area. |
| <b>IP Address</b> | The IP address of the domain controller.                                                                                                                                                     |

| Field                | Description                                                                                                                                                                                                                                                                                                                                                                                                                                                                                                                          |
|----------------------|--------------------------------------------------------------------------------------------------------------------------------------------------------------------------------------------------------------------------------------------------------------------------------------------------------------------------------------------------------------------------------------------------------------------------------------------------------------------------------------------------------------------------------------|
| <b>Monitor Using</b> | <p>Monitor Active Directory domain controllers for user identity information by one of these methods:</p> <ul style="list-style-type: none"> <li>• WMI: Monitor Active Directory directly with the WMI infrastructure.</li> <li>• Agent name: If you have defined agents to monitor Active Directory for user information, select the Agent protocol and choose the agent from the dropdown list that you would like to use. For more information about agents, see <a href="#">Active Directory Agents, on page 371</a>.</li> </ul> |

Table 22: Passive ID Domain Controllers (DC) Edit Window

| Field Name         | Description                                                                                                                                                                                                                                                                                                                                                                                                                                                                                                                          |
|--------------------|--------------------------------------------------------------------------------------------------------------------------------------------------------------------------------------------------------------------------------------------------------------------------------------------------------------------------------------------------------------------------------------------------------------------------------------------------------------------------------------------------------------------------------------|
| <b>Host FQDN</b>   | Enter the fully qualified domain name of the server on which the domain controller is located.                                                                                                                                                                                                                                                                                                                                                                                                                                       |
| <b>Description</b> | Enter a unique description for this domain controller in order to easily identify it.                                                                                                                                                                                                                                                                                                                                                                                                                                                |
| <b>User Name</b>   | The administrator's user name for accessing Active Directory.                                                                                                                                                                                                                                                                                                                                                                                                                                                                        |
| <b>Password</b>    | The administrator's password for accessing Active Directory.                                                                                                                                                                                                                                                                                                                                                                                                                                                                         |
| <b>Protocol</b>    | <p>Monitor Active Directory domain controllers for user identity information by one of these methods:</p> <ul style="list-style-type: none"> <li>• WMI: Monitor Active Directory directly with the WMI infrastructure.</li> <li>• Agent name: If you have defined agents to monitor Active Directory for user information, select the Agent protocol and choose the agent from the dropdown list that you would like to use. For more information about agents, see <a href="#">Active Directory Agents, on page 371</a>.</li> </ul> |

Active Directory groups are defined and managed from Active Directory and the groups for the Active Directory that is joined to this node can be viewed from this tab. For more information about Active Directory, see <https://msdn.microsoft.com/en-us/library/bb742437.aspx>.

Table 23: Active Directory Advanced Settings

| Field Name                     | Description                                                                                                                                                                                                                                                                                                                 |
|--------------------------------|-----------------------------------------------------------------------------------------------------------------------------------------------------------------------------------------------------------------------------------------------------------------------------------------------------------------------------|
| <b>History interval</b>        | The time during which the Passive Identity service reads user login information that already occurred. This is required upon startup or restart of the Passive Identity service to catch up with events generated while it was unavailable. When the Endpoint probe is active, it maintains the frequency of this interval. |
| <b>User session aging time</b> | The amount of time the user can be logged in. The Passive Identity service identifies new user login events from the DC, however the DC does not report when the user logs off. The aging time enables Cisco ISE to determine the time interval for which the user is logged in.                                            |
| <b>NTLM Protocol settings</b>  | You can select either NTLMv1 or NTLMv2 as the communications protocol between Cisco ISE and the DC. NTLMv2 is the recommended default.                                                                                                                                                                                      |

## Additional Passive Identity Service Providers

In order to enable ISE to provide identity information (Passive Identity Service ) to consumers that subscribe to the service (subscribers), you must first configure an ISE probe, which connects to the identity provider.

The table below provides details about all of the provider and probe types available from ISE. For more information about Active Directory, see [Active Directory as a Probe and a Provider, on page 363](#).

You can define these provider types:

Table 24: Provider Types

| Provider Type (Probe) | Description                                                                                                                                                                                                                                                                                                                                                  | Source System (Provider)           | Technology                                                       | User Identity Information Collected                                                                   | Document Link                                                           |
|-----------------------|--------------------------------------------------------------------------------------------------------------------------------------------------------------------------------------------------------------------------------------------------------------------------------------------------------------------------------------------------------------|------------------------------------|------------------------------------------------------------------|-------------------------------------------------------------------------------------------------------|-------------------------------------------------------------------------|
| Active Directory (AD) | <p>A highly secure and precise source, as well as the most common, from which to receive user information.</p> <p>As a probe, AD works with WMI technology to deliver authenticated user identities.</p> <p>In addition, AD itself, rather than the probe, functions as a source system (a provider) from which other probes retrieve user data as well.</p> | Active Directory Domain Controller | WMI                                                              | <ul style="list-style-type: none"> <li>• User name</li> <li>• IP address</li> <li>• Domain</li> </ul> | <a href="#">Active Directory as a Probe and a Provider, on page 363</a> |
| Agents                | <p>A native 32-bit application installed on Active Directory domain controllers or on member servers.</p> <p>The Agent probe is a quick and efficient solution when using Active Directory for user identity information.</p>                                                                                                                                |                                    | Agents installed on the domain controller or on a member server. | <ul style="list-style-type: none"> <li>• User name</li> <li>• IP address</li> <li>• Domain</li> </ul> | <a href="#">Active Directory Agents, on page 371</a>                    |
| Endpoint              | Always runs in the background in addition to other configured probes, in order to verify whether the user is still connected.                                                                                                                                                                                                                                |                                    | WMI                                                              | Whether the user is still connected                                                                   | <a href="#">Endpoint Probe, on page 404</a>                             |
| SPAN                  |                                                                                                                                                                                                                                                                                                                                                              |                                    | SPAN, installed on the switch, and Kerberos messages             | <ul style="list-style-type: none"> <li>• User name</li> <li>• IP address</li> <li>• Domain</li> </ul> | <a href="#">SPAN, on page 380</a>                                       |

| Provider Type (Probe) | Description                                                                                                                                         | Source System (Provider)                                                                                     | Technology                                                      | User Identity Information Collected                                                                                          | Document Link                                 |
|-----------------------|-----------------------------------------------------------------------------------------------------------------------------------------------------|--------------------------------------------------------------------------------------------------------------|-----------------------------------------------------------------|------------------------------------------------------------------------------------------------------------------------------|-----------------------------------------------|
|                       | Sits on the network switch in order to listen to network traffic, and extract user identity information based on Active Directory data.             |                                                                                                              |                                                                 |                                                                                                                              |                                               |
| API providers         | Gather user identity information from any system programmed to communicate with a RESTful API client, using the RESTful API service offered by ISE. | Any system programmed to communicate with a REST API client.                                                 | RESTful APIs. User identity sent to subscribers in JSON format. | <ul style="list-style-type: none"> <li>• User name</li> <li>• IP address</li> <li>• Port range</li> <li>• Domain</li> </ul>  | <a href="#">API Providers, on page 375</a>    |
| Syslog                | Parse syslog messages and retrieve user identities, including MAC addresses.                                                                        | <ul style="list-style-type: none"> <li>• Regular syslog message providers</li> <li>• DHCP servers</li> </ul> | Syslog messages                                                 | <ul style="list-style-type: none"> <li>• User name</li> <li>• IP address</li> <li>• MAC address</li> <li>• Domain</li> </ul> | <a href="#">Syslog Providers, on page 382</a> |



**Note** pxGrid sends 200 events per second for session topics to avoid overloading the clients. If the publisher sends more than 200 events, the additional events are queued and sent in next batch.

If pxGrid consistently receives more than 200 events per second for a prolonged period of time, it might consume more memory than usual for storing the backlog events. This might affect the performance of pxGrid.

## Active Directory Agents

From the Passive Identity service work center install the native 32-bit application, Domain Controller (DC) agents, anywhere on the Active Directory (AD) domain controller (DC) or on a member server (based on your configurations) to retrieve user identity information from AD and then send those identities to the subscribers you have configured. The Agent probe is a quick and efficient solution when using Active Directory for user identity information. Agents can be installed on a separate domain, or on the AD domain, and once installed, they provide status updates to ISE once every minute.

The agents can be either automatically installed and configured by ISE, or you can manually install them. Upon installation, the following occurs:

- The agent and its associated files are installed at the following path: **Program Files/Cisco/Cisco ISE PassiveID Agent**

- A config file called **PICAgent.exe.config** is installed indicating the logging level for the agent. You can manually change the logging level from within the config file.
- The CiscoISEPICAgent.log file is stored with all logging messages.
- The nodes.txt file contains the list of all nodes in the deployment with which the agent can communicate. The agent contacts the first node in the list. If that node cannot be contacted, the agent continues to attempt communication according to the order of the nodes in the list. For manual installations, you must open the file and enter the node IP addresses. Once installed (manually or automatically), you can only change this file by manually updating it. Open the file and add, change or delete node IP addresses as necessary.
- The Cisco ISE PassiveID Agent service runs on the machine, which you can manage from the Windows Services dialog box.
- ISE supports up to 100 domain controllers, while each agent can monitor up to 10 domain controllers. In order to monitor 100 domain controllers, you must configure 10 agents.
- The Active Directory agents are only supported on Windows Server 2008 and higher. If you cannot install agents, then use the Active Directory probe for passive identity services. For more information, see [Active Directory as a Probe and a Provider, on page 363](#).



---

**Note** Even if you are running the AD agent on a member server, it still queries the Active Directory for the login requests.

---

## Automatically Install and Deploy Active Directory Agents

When configuring the Agent provider to monitor domain controllers for user identities, the agent must be installed on either a member server or on a domain controller. The agents can be either automatically installed by ISE, or you can manually install them. After installation, automatic or manual, you must then configure the installed agent to monitor specified domain controllers rather than the default WMI. This process describes how to enable automatic installation and configure the agent to monitor a domain controller.

### Before you begin

Before you begin:

- Configure reverse lookup for the relevant DNS servers from the server side. For more information about the DNS server configuration requirements for ISE, see [DNS Server, on page 328](#)
- Ensure Microsoft .NET Framework is updated for the machine designated for the agents, to a minimum of version 4.0. For more information about the .NET framework, see <https://www.microsoft.com/net/framework>.
- Active Passive ID and pxGrid services. For more information, see [Initial Setup and Configuration, on page 362](#).
- Create an AD join point and add at least one domain controller. For more information about creating join points, see [Active Directory as a Probe and a Provider, on page 363](#).

Use AD user groups for the AD, Agents, SPAN and Syslog probes. For more information about AD groups, see [Configure Active Directory User Groups, on page 334](#).



- 
- Step 1** Choose **Work Centers > PassiveID > Providers** and then choose **Agents** from the left panel.
- Step 2** To add a new agent, click **Add** from the top of the table.
- Step 3** To create the new agent and automatically install it on the host that you indicate in this configuration, select **Deploy New Agent**.
- Step 4** Complete all mandatory fields in order to configure the client correctly. For more information, see [Active Directory Agent Settings, on page 374](#).
- Step 5** Click **Deploy**.  
The agent is automatically installed on the host according to the domain that you indicated in the configuration, and the settings are saved. The agent now also appears in the Agents table and can be applied to monitor specified domain controllers, as described in the following steps.
- Step 6** Choose **Work Centers > PassiveID > Providers** and then choose **Active Directory** from the left panel to view all currently configured join points.
- Step 7** Click the link for the join point from which you would like to enable the agent you created.
- Step 8** Choose the **Passive ID** tab to configure the domain controllers that you added as part of the prerequisites.
- Step 9** Select the domain controller that you would like to monitor with the agent you created and click **Edit**.
- Step 10** From the **Protocol** drop-down list, select **Agent**
- Step 11** Select the agent you created from the **Agent** drop-down list. Enter the user name and password credentials of the agent that you created, and click **Save**.

The user name and password credentials are used to install the agent on the domain controller. Finally, when you click on **Deploy**, the *picagent.exe* is copied from */opt/pbis/bin* to the specified Windows machine.

---

## Manually Install and Deploy Active Directory Agents

When configuring the Agent provider to monitor domain controllers for user identities, the agent must be installed on either a member server or on a domain controller. The agents can be either automatically installed by ISE, or you can manually install them. After installation, automatic or manual, you must then configure the installed agent to monitor specified domain controllers rather than the default WMI. This process describes how to manually install and configure the agent to monitor a domain controller.

### Before you begin

Before you begin:

- Configure reverse lookup for the relevant DNS servers from the server side. For more information about the DNS server configuration requirements for ISE, see [DNS Server, on page 328](#)
- Ensure Microsoft .NET Framework is updated for the machine designated for the agents, to a minimum of version 4.0. For more information about the .NET framework, see <https://www.microsoft.com/net/framework>.
- Active Passive ID and pxGrid services. For more information, see [Initial Setup and Configuration, on page 362](#).
- Create an AD join point and add at least one domain controller. For more information about creating join points, see [Active Directory as a Probe and a Provider, on page 363](#).

Use AD user groups for the AD, Agents, SPAN and Syslog probes. For more information about AD groups, see [Configure Active Directory User Groups, on page 334](#).

- 
- Step 1** Choose **Work Centers > PassiveID > Providers** and then choose **Agents** from the left panel.
- Step 2** Click **Download Agent** to download the `picagent-installer.zip` file for manual installation. The file is downloaded to your standard Windows Download folder.
- Step 3** Place the zip file on the designated host machine and run the installation.
- Step 4** From the ISE GUI, again choose **Work Centers > PassiveID > Providers** and then choose **Agents** from the left panel.
- Step 5** To configure a new agent, click **Add** from the top of the table.
- Step 6** To configure the agent that you have already installed on the host machine, select **Register Existing Agent**.
- Step 7** Complete all mandatory fields in order to configure the client correctly. For more information, see [Active Directory Agent Settings, on page 374](#).
- Step 8** Click **Save**.  
The agent settings are saved. The agent now also appears in the Agents table and can be applied to monitor specified domain controllers, as described in the following steps.
- Step 9** Choose **Work Centers > PassiveID > Providers** and then choose **Active Directory** from the left panel to view all currently configured join points.
- Step 10** Click the link for the join point from which you would like to enable the agent you created.
- Step 11** Choose the **Passive ID** tab to configure the domain controllers that you added as part of the prerequisites.
- Step 12** Select the domain controller that you would like to monitor with the agent you created and click **Edit**.
- Step 13** From the **Protocol** drop-down list, select **Agent**.
- Step 14** Select the agent you created from the **Agent** drop-down list. Enter the user name and password to connect to the agent, and click **Save**.  
The user account must have the necessary permissions to read security events. A user account for a WMI-based agent must have WMI/DCOM permissions.
- 

## Uninstall the Agent

Agents, installed automatically or manually, can be easily (manually) uninstalled directly from Windows.

- 
- Step 1** From the Windows dialog, go to **Programs and Features**.
- Step 2** Find and select the Cisco ISE PassiveID Agent in the list of installed programs.
- Step 3** Click **Uninstall**.
- 

## Active Directory Agent Settings

Allow ISE to automatically install agents on a specified host in the network in order to retrieve user identity information from different Domain Controllers (DC) and deliver that information to Passive Identity service subscribers.

To create and manage agents, choose **Providers > Agents**. See [Automatically Install and Deploy Active Directory Agents, on page 372](#).

Table 25: Agents Window

| Field Name        | Description                                                                                  |
|-------------------|----------------------------------------------------------------------------------------------|
| <b>Name</b>       | The agent name as you configured it.                                                         |
| <b>Host</b>       | The fully qualified domain name of the host on which the agent is installed.                 |
| <b>Monitoring</b> | This is a comma separated list of domain controllers that the specified agent is monitoring. |

Table 26: Agents New

| Field                                              | Description                                                                                                                                                                                                                                                                                    |
|----------------------------------------------------|------------------------------------------------------------------------------------------------------------------------------------------------------------------------------------------------------------------------------------------------------------------------------------------------|
| <b>Deploy New Agent or Register Existing Agent</b> | <ul style="list-style-type: none"> <li>• Deploy New Agent: Install a new agent on the specified host.</li> <li>• Register Existing Agent: Manually install the agent on the host and then configure that agent from this screen for Passive Identity service to enable the service.</li> </ul> |
| <b>Name</b>                                        | Enter a name by which you can easily recognize the agent.                                                                                                                                                                                                                                      |
| <b>Description</b>                                 | Enter a description by which you can easily recognize the agent.                                                                                                                                                                                                                               |
| <b>Host FQDN</b>                                   | This is the fully qualified domain name for the host on which the agent is installed (register existing agent), or is to be installed (automatic deployment).                                                                                                                                  |
| <b>User Name</b>                                   | <p>Enter your user name in order to access the host on which to install the agent. Passive Identity service uses these credentials in order to install the agent for you.</p> <p>The user account must have permissions to connect remotely and install the PIC agent.</p>                     |
| <b>Password</b>                                    | Enter your user password in order to access the host on which to install the agent. Passive Identity service uses these credentials in order to install the agent for you.                                                                                                                     |

## API Providers

The API Providers feature in Cisco ISE enables you to push user identity information from your customized program or from the terminal server (TS)-Agent to the built-in ISE passive identity services REST API service. In this way, you can customize a programmable client from your network to send user identities that were collected from any network access control (NAC) system to the service. Furthermore, the Cisco ISE API

provider enables you to interface with network applications such as the TS-Agent on a Citrix server, where all users have the same IP address but are assigned unique ports.

For example, an agent running on a Citrix server that provides identity mappings for users authenticated against an Active Directory (AD) server can send REST requests to ISE to add or delete a user session whenever a new user logs in or off. ISE then takes the user identity information, including the IP address and assigned ports, delivered from the client and sends it to pre-configured subscribers, such as the Cisco Firepower Management Center (FMC).

The ISE REST API framework implements the REST service over the HTTPS protocol (no client certificate validation necessary) and the user identity information is delivered in JSON (JavaScript Object Notation) format. For more information about JSON, see <http://www.json.org/>.

The ISE REST API service parses user identities and in addition, maps that information to port ranges, in order to distinguish between the different users logged in simultaneously to one system. Everytime a port is allocated to a user, the API sends a message to ISE.

### The REST API Provider Flow

After you have configured a bridge to your customized client from ISE by declaring that client as a Provider for ISE and enabling that specific customized program (the client) to send RESTful requests, the ISE REST service works in the following way:

1. For client authentication, Cisco ISE requires an authentication token. A customized program on the client machine sends a request for an authentication token when initiating contact and then every time ISE notifies that the previous token has expired. The token is returned in response to the request, enabling ongoing communication between the client, and the ISE service.
2. After a user has logged into the network, the client retrieves user identity information and posts that information to the ISE REST service using the API Add command.
3. Cisco ISE receives and maps the user identity information.
4. Cisco ISE sends the mapped user identity information to the subscriber.
5. Whenever necessary, the customized machine can send a request to remove user information by sending a Remove API call and including the user ID received as the response when the Add call was sent.

### Work with REST API Providers in ISE

Follow these steps to activate the REST service in ISE:

1. Configure the client side. For more information, see the client user documentation.
2. Activate Passive ID and pxGrid services. For more information, see [Initial Setup and Configuration, on page 362](#).
3. Ensure you have properly configured the DNS server, including configuring reverse lookup for the client machine from ISE. For more information about the DNS server configuration requirements for , see [DNS Server, on page 328](#)
4. See [Configure a Bridge to the ISE REST Service for Passive Identity Services, on page 377](#).



---

**Note** To configure the API Provider to work with a TS-Agent add the TS-Agent information when creating a bridge from ISE to that agent, and then consult with the TS-Agent documentation for information about sending API calls.

---

5. Generate an authentication token and send add and remove requests to the API service.

## Configure a Bridge to the ISE REST Service for Passive Identity Services

In order to enable the ISE REST API service to receive information from a specific client, you must first define the specific client from Cisco ISE. You can define multiple REST API clients with different IP addresses.

### Before you begin

Before you begin:

- Ensure you have activated Passive ID and pxGrid services. For more information, see [Initial Setup and Configuration, on page 362](#).
- Ensure you have properly configured the DNS server, including configuring reverse lookup for the client machine from Cisco ISE. For more information about the DNS server configuration requirements for Cisco ISE, see [DNS Server, on page 328](#)

- 
- Step 1** Choose **Work Centers > PassiveID > Providers** and then choose **API Providers** from the left panel. The API Providers table is displayed, including status information for each existing client.
- Step 2** To add a new client, click **Add** from the top of the table.
- Step 3** Complete all mandatory fields in order to configure the client correctly. For more information, see [API Provider Settings, on page 378](#).
- Step 4** Click **Submit**. The client configuration is saved and the screen displays the updated API Providers table. The client can now send posts to the ISE REST service.
- 

### What to do next

Set up your customized client to post authentication tokens and user identities to the ISE REST service. See [Send API Calls to the Passive ID REST Service, on page 377](#).

## Send API Calls to the Passive ID REST Service

### Before you begin

[Configure a Bridge to the ISE REST Service for Passive Identity Services, on page 377](#)

---

- Step 1** Enter the Cisco ISE URL in the address bar of your browser (for example, *https://<ise hostname or ip address>/admin/*)
- Step 2** Enter the username and password that you specified and configured from the **API Providers** window. For more information, see [Configure a Bridge to the ISE REST Service for Passive Identity Services, on page 377](#).

- Step 3** Press **Enter**.
- Step 4** Enter the API call in the URL Address field of the target node.
- Step 5** Click **Send** to issue the API call.

### What to do next

See [API Calls, on page 378](#) for more information and details about the different API calls, their schemas and their results.

## API Provider Settings



**Note** The full API definition and object schemas can be retrieved with a request call as follows:

- For the full API specifications (wadl)—[https://YOUR\\_ISE:9094/application.wadl](https://YOUR_ISE:9094/application.wadl)
- For the API model and object schemas—[https://YOUR\\_ISE:9094/application.wadl/xsd0.xsd](https://YOUR_ISE:9094/application.wadl/xsd0.xsd)

*Table 27: API Providers Settings*

| Field       | Description                                                                                                                                                                 |
|-------------|-----------------------------------------------------------------------------------------------------------------------------------------------------------------------------|
| Name        | Enter a unique name for this client that distinguishes it quickly and easily from other clients.                                                                            |
| Description | Enter a clear description of this client.                                                                                                                                   |
| Status      | Select <b>Enabled</b> to enable the client to interact with the REST services immediately upon completing configuration.                                                    |
| Host/ IP    | Enter the IP address for the client host machine. Ensure you have properly configured the DNS server, including configuring reverse lookup for the client machine from ISE. |
| User name   | Create a unique user name to be used when posting to the REST service.                                                                                                      |
| Password    | Create a unique password to be used when posting to the REST service.                                                                                                       |

## API Calls

Use these API calls to manage user identity events for Passive Identity services with Cisco ISE.

### Purpose: Generate Authentication Token

- Request

POST

https://<PIC IP address>:9094/api/fimi\_platform/v1/identityauth/generatetoken

The request should contain the BasicAuth authorization header. Provide the API provider's credentials as previously created from the ISE-PIC GUI. For more information see [API Provider Settings, on page 378](#).

- **Response Header**

The header includes the X-auth-access-token. This is the token to be used when posting additional REST requests.

- **Response Body**

HTTP 204 No Content

### Purpose: Add User

- **Request**

POST

https://<PIC IP address>:9094/api/identity/v1/identity/useridentity

Add X-auth-access-token in the header of the POST request, for example, Header: X-auth-access-token, Value: f3f25d81-3ac5-43ee-bbfb-20955643f6a7

- **Response Header**

201 Created

- **Response Body**

```
{
 "user": "<username>",
 "srcPatRange": {
 "userPatStart": <user PAT start value>,
 "userPatEnd": <user PAT end value>,
 "patRangeStart": <PAT range start value>
 },
 "srcIpAddress": "<src IP address>",
 "agentInfo": "<Agent name>",
 "timestamp": "<ISO_8601 format i.e. 'YYYY-MM-DDTHH:MM:SSZ' >",
 "domain": "<domain>"
}
```

- **Notes**

- srcPatRange can be removed in above json to create a single IP user binding.
- Response body contains the "ID" which is the unique identifier for the user session binding created. Use this ID when sending a DELETE request to indicate which user should be removed.

- This response also contains the self link which is the URL for this newly created user session binding.

### Purpose: Remove User

- **Request**

DELETE

https://<PIC IP address>:9094/api/identity/v1/identity/useridentity/<id>

In <id> enter the ID as was received from the Add response.

Add the X-auth-access-token in the header of the DELETE request, for example, Header:

X-auth-access-token, Value: f3f25d81-3ac5-43ee-bbfb-20955643f6a7

- **Response Header**

200 OK

- **Response Body**

Response body contains the details about the user session binding which got deleted.

## SPAN

SPAN is a Passive Identity service that allows you to quickly and easily enable Cisco ISE to listen to the network and retrieve user information without having to configure Active Directory to work directly with Cisco ISE. SPAN sniffs network traffic, specifically examining Kerberos messages, extracts user identity information also stored by Active Directory and sends that information to ISE. ISE then parses the information, ultimately delivering user name, IP address and domain name to the subscribers that you have also already configured from ISE.

In order for SPAN to listen to the network and extract Active Directory user information, ISE and Active Directory must both be connected to the same switch on the network. In this way, SPAN can copy and mirror all user identity data from Active Directory.

With SPAN, user information is retrieved in the following way:

1. The user endpoint logs in to the network.
2. Log in and user data are stored in Kerberos messages.
3. When the user logs in and the user data passes through the switch, SPAN mirrors the network data.
4. Cisco ISE listens to the network for user information and retrieves the mirrored data from the switch.
5. Cisco ISE parses the user information and updates passive ID mappings.
6. Cisco ISE delivers the parsed user information to the subscribers.

## Working with SPAN

### Before you begin

In order to enable ISE to receive SPAN traffic from a network switch, you must first define which nodes and node interfaces are to listen to the switch. You can configure SPAN in order to listen to the different installed



ISE nodes. For each node, only one interface can be configured to listen to the network and the interface used to listen must be dedicated to SPAN only.

Before you begin, ensure you have activated Passive ID and pxGrid services. Only nodes for which Passive ID has been turned on will appear in the list of available interfaces for configuring SPAN. For more information, see [Initial Setup and Configuration, on page 362](#).

In addition, you must:

- Ensure Active Directory is configured on your network.
- Run a CLI on the switch in the network that is also connected to Active Directory in order to ensure the switch can communicate with ISE.
- Configure the switch to mirror the network from AD.
- Configure a dedicated ISE network interface card (NIC) for SPAN. This NIC is used only for SPAN traffic.
- Ensure the NIC that you have dedicated to SPAN is activated via the command line interface.
- Create a VACL that sends only Kerberos traffic into the SPAN port.

---

**Step 1** Choose **Work Centers > PassiveID > Providers** and then choose **SPAN** from the left panel to configure SPAN.

**Step 2** **Note** We recommend that the GigabitEthernet0 network interface card (NIC) remain available and that you select any other available NIC for configuring SPAN. GigabitEthernet0 is used for system management purposes.

Enter a meaningful description (optional), select status **Enabled**, and choose the nodes and the relevant NICs that will be used to listen to the network switch. For more information, see [SPAN Settings, on page 381](#).

**Step 3** Click **Save**.

The SPAN configuration is saved and ISE-PIC ISE is now actively listening to network traffic.

---

## SPAN Settings

From each node that you have deployed, quickly and easily configure ISE to receive user identities by installing SPAN on a client network.

*Table 28: SPAN Settings*

| Field       | Description                                                                                   |
|-------------|-----------------------------------------------------------------------------------------------|
| Description | Enter a unique description to remind you of which nodes and interfaces are currently enabled. |
| Status      | Select <b>Enabled</b> to enable the client immediately upon completing configuration.         |

| Field         | Description                                                                                                                                                                                                                                                                                                                                                                      |
|---------------|----------------------------------------------------------------------------------------------------------------------------------------------------------------------------------------------------------------------------------------------------------------------------------------------------------------------------------------------------------------------------------|
| Interface NIC | <p>Select one or more of the nodes installed for ISE, and then for each selected node, choose the node interface that is to listen to the network for information.</p> <p><b>Note</b> We recommend that the GigabitEthernet0 NIC remain available and that you select any other available NIC for configuring SPAN. GigabitEthernet0 is used for system management purposes.</p> |

## Syslog Providers

Passive Identity service parses syslog messages from any client (identity data provider) that delivers syslog messages, including regular syslog messages (from providers such as InfoBlox, Blue Coat, BlueCat, and Lucent) as well as DHCP syslog messages, and sends back user identity information, including MAC addresses. This mapped user identity data is then delivered to subscribers.

You can specify the syslog clients from which to receive the user identity data (see [Configure Syslog Clients, on page 383](#)). While configuring the provider, you must specify the connection method (TCP or UDP) and the syslog template to be used for parsing.



**Note** When TCP is the configured connection type, if there is a problem with the message header and the host name cannot be parsed, ISE attempts to match the IP address received in the packet to the IP address of any of the providers in the list of providers that have already been configured for Syslog messages in ISE. To view this list, choose **Work Centers > PassiveID > Providers > Syslog Providers**. We recommend that you check the message headers and customize if necessary to guarantee parsing succeeds. For more information about customizing headers, see [Customize Syslog Headers, on page 389](#).

The syslog probe sends syslog messages that are received to the ISE parser, which maps the user identity information, and publishes that information to ISE. ISE then delivers the parsed and mapped user identity information to the Passive Identity service subscribers.

To parse syslog messages for user identity from ISE-PIC ISE:

- Configure syslog clients from which to receive user identity data. See [Configure Syslog Clients, on page 383](#).
- Customize a single message header. See [Customize Syslog Headers, on page 389](#).
- Customize message bodies by creating templates. See [Customize the Syslog Message Body, on page 388](#).
- Use the message templates pre-defined in ISE when configuring your syslog client as the message template used for parsing, or base your customized header or body templates on these pre-defined templates. See [Work with Syslog Predefined Message Templates, on page 392](#).

## Configure Syslog Clients

In order to enable Cisco ISE to listen to syslog messages from a specific client, you must first define the specific client from Cisco ISE. You can define multiple providers with different IP addresses.

### Before you begin

Before you begin, ensure you have activated Passive ID and pxGrid services. For more information, see [Initial Setup and Configuration, on page 362](#).

- 
- Step 1** Choose **Work Centers > PassiveID > Providers** and then choose **Syslog Providers** from the left panel. The Syslog Providers table is displayed, including status information for each existing client.
  - Step 2** To configure a new syslog client, click **Add** from the top of the table.
  - Step 3** Complete all mandatory fields (see [Syslog Settings, on page 383](#) for more details) and create a message template if necessary (see [Customize the Syslog Message Body, on page 388](#) for more details) to configure the client correctly.
  - Step 4** Click **Submit**.
- 

### Syslog Settings

Configure Cisco ISE to receive user identities, including MAC addresses, by way of syslog messages from a specific client. You can define multiple providers with different IP addresses.

*Table 29: Syslog Providers*

| Field Name         | Description                                                                           |
|--------------------|---------------------------------------------------------------------------------------|
| <b>Name</b>        | Enter a unique name that distinguishes this configured client quickly and easily.     |
| <b>Description</b> | A meaningful description of this Syslog provider.                                     |
| <b>Status</b>      | Select <b>Enabled</b> to enable the client immediately upon completing configuration. |
| <b>Host</b>        | Enter the FQDN of the host machine.                                                   |

| Field Name             | Description                                                                                                                                                                                                                                                                                                                                                                                                                                                                                                                                                                                                                                                                                                                                                                               |
|------------------------|-------------------------------------------------------------------------------------------------------------------------------------------------------------------------------------------------------------------------------------------------------------------------------------------------------------------------------------------------------------------------------------------------------------------------------------------------------------------------------------------------------------------------------------------------------------------------------------------------------------------------------------------------------------------------------------------------------------------------------------------------------------------------------------------|
| <b>Connection Type</b> | <p>Enter UDP or TCP to indicate the channel by which ISE listens for syslog messages.</p> <p><b>Note</b> When TCP is the configured connection type, if there is a problem with the message header and the host name cannot be parsed, then Cisco ISE attempts to match the IP address received in the packet to the IP address of any of the providers in the list of providers that have already been configured for Syslog messages in Cisco ISE.</p> <p>To view this list, choose <b>Work Centers &gt; PassiveID &gt; Providers &gt; Syslog Providers</b>. We recommend that you check the message headers and customize if necessary to ensure that parsing succeeds. For more information about customizing headers, see <a href="#">Customize Syslog Headers, on page 389</a>.</p> |

| Field Name | Description |
|------------|-------------|
| Template   |             |

| Field Name | Description                                                                                                                                                                                                                                                                                                                                                                                                                                                                                                                                                                                                                                                                                                                                                                                                                                                                                                                                                                                                                                                                                                                                                                                                                                                                                                                                                                                                                                                                                                                                                                                                                                                                                                                                                                                                                              |
|------------|------------------------------------------------------------------------------------------------------------------------------------------------------------------------------------------------------------------------------------------------------------------------------------------------------------------------------------------------------------------------------------------------------------------------------------------------------------------------------------------------------------------------------------------------------------------------------------------------------------------------------------------------------------------------------------------------------------------------------------------------------------------------------------------------------------------------------------------------------------------------------------------------------------------------------------------------------------------------------------------------------------------------------------------------------------------------------------------------------------------------------------------------------------------------------------------------------------------------------------------------------------------------------------------------------------------------------------------------------------------------------------------------------------------------------------------------------------------------------------------------------------------------------------------------------------------------------------------------------------------------------------------------------------------------------------------------------------------------------------------------------------------------------------------------------------------------------------------|
|            | <p>A template indicates precise body message structure so that the parser can identify the pieces of information within the syslog message that should be parsed, mapped and delivered.</p> <p>For example, a template can indicate the exact position of the user name so that the parser can find the user name in every message received.</p> <p>From this field, indicate the template (for the body of the syslog message) to be used in order to recognize and correctly parse the syslog message.</p> <p>Choose either from the pre-defined dropdown list, or click <b>New</b> to create your own customized template. For more information about creating new templates, see <a href="#">Customize the Syslog Message Body, on page 388</a>. Most of the pre-defined templates use regular expressions, and customized templates should also use regular expressions.</p> <p><b>Note</b> Only customized templates can be edited or removed, while pre-defined system templates in the dropdown cannot be altered.</p> <p>ISE currently offers these pre-defined DHCP provider templates:</p> <ul style="list-style-type: none"> <li>• InfoBlox</li> <li>• BlueCat</li> <li>• Lucent_QIP</li> <li>• DHCPD</li> <li>• MSAD DHCP</li> </ul> <p><b>Note</b> DHCP syslog messages do not contain user names. Therefore, these messages are delivered from the parser with a delay so that Cisco ISE can first check users registered in the local session directory (displayed from Live Sessions) and attempt to match those users by their IP addresses to the IP addresses listed in the DHCP syslog messages received, in order to correctly parse and deliver user identity information.</p> <p>If the data received from a DHCP syslog message cannot be matched to any of the currently logged in users, then the message</p> |

| Field Name            | Description                                                                                                                                                                                                                                                                                                                                                                                                                                                          |
|-----------------------|----------------------------------------------------------------------------------------------------------------------------------------------------------------------------------------------------------------------------------------------------------------------------------------------------------------------------------------------------------------------------------------------------------------------------------------------------------------------|
|                       | <p>is not parsed and user identity is not delivered.</p> <p>Cisco ISE offers these pre-defined regular syslog provider templates:</p> <ul style="list-style-type: none"> <li>• ISE</li> <li>• ACS</li> <li>• F5_VPN</li> <li>• ASA_VPN</li> <li>• Blue Coat</li> <li>• Aerohive</li> <li>• Safe connect_NAC</li> <li>• Nortel_VPN</li> </ul> <p>For information about templates, see <a href="#">Work with Syslog Predefined Message Templates, on page 392</a>.</p> |
| <b>Default Domain</b> | <p>If the domain is not identified in the syslog message for the specific user, this default domain is automatically assigned to the user in order to ensure that all users are assigned a domain.</p> <p>With the default domain or with the domain that was parsed from the message, the user name is appended to username@domain, thereby including that domain, in order to get more information about the user and user groups.</p>                             |

## Customize Syslog Message Structures (Templates)

A template indicates precise message structure so that the parser can identify the pieces of information within the syslog message that should be parsed, mapped and delivered. For example, a template can indicate the exact position of the user name so that the parser can find the user name in every message received. Templates determine the supported structures for both new and remove mapping messages.

Cisco ISE enables you to customize a single message header and multiple body structures, to be used by the Passive ID parser.

The templates should include regular expressions to define the structure for user name, IP address, MAC address and domain in order to enable the Passive ID parser to correctly identify whether the message is to add or remove user identity mapping and to correctly parse the user details.

When customizing your message templates, you can choose to base your customization on the message templates pre-defined in ISE-PIC ISE by consulting with the regular expressions and message structures used within those pre-defined options. For more information about the pre-defined template regular expressions, message structures, examples and more, see [Work with Syslog Predefined Message Templates, on page 392](#).

You can customize:

- A single message header—[Customize Syslog Headers, on page 389](#)
- Multiple message bodies—[Customize the Syslog Message Body, on page 388](#).




---

**Note** DHCP syslog messages do not contain user names. Therefore, these messages are delivered from the parser with a delay so that Cisco ISE can first check users registered in the local session directory (displayed from Live Sessions) and attempt to match those users by their IP addresses to the IP addresses listed in the DHCP syslog messages received, in order to correctly parse and deliver user identity information. If the data received from a DHCP syslog message cannot be matched to any of the currently logged in users, then the message is not parsed and user identity is not delivered.

The delay necessary to properly match, parse and map details from DHCP messages cannot be applied to customized templates, and therefore it is not recommended that DHCP message templates be customized. Instead, use any of the pre-defined DHCP templates.

---

## Customize the Syslog Message Body

Cisco ISE enables you to customize your own syslog message templates (by customizing the message body) to be parsed by the Passive ID parser. The templates should include regular expressions to define the structure for user name, IP address, MAC address and domain.




---

**Note** DHCP syslog messages do not contain user names. Therefore, these messages are delivered from the parser with a delay so that Cisco ISE can first check users registered in the local session directory (displayed from Live Sessions) and attempt to match those users by their IP addresses to the IP addresses listed in the DHCP syslog messages received, to correctly parse and deliver user identity information. If the data received from a DHCP syslog message cannot be matched to any of the currently logged in users, then the message is not parsed and user identity is not delivered.

The delay necessary to properly match, parse and map details from DHCP messages cannot be applied to customized templates, and therefore it is not recommended that DHCP message templates be customized. Instead, use any of the pre-defined DHCP templates.

---

Create and edit syslog message body templates from within the syslog client configuration screen.




---

**Note** You can only edit your own customized templates. Pre-defined templates offered by the system cannot be changed.

---

- 
- Step 1** Choose **Work Centers > PassiveID > Providers** and then choose **Syslog Providers** from the left panel. The Syslog Providers table is displayed, including status information for each existing client.
- Step 2** Click **Add** to add a new syslog client or **Edit** to update an already configured client. For more information about configuring and updating syslog clients, see [Configure Syslog Clients, on page 383](#).
- Step 3** In the **Syslog Providers** window, click **New** to create a new message template. To edit an existing template, select the template from the dropdown list and click **Edit**.



- Step 4** Complete all mandatory fields.  
For information about how to enter the values correctly, see [Syslog Customized Template Settings and Examples, on page 390](#).
- Step 5** Click **Test** to ensure the message is correctly parsed based on the strings you have entered.
- Step 6** Click **Save**.
- 

## Customize Syslog Headers

Syslog headers also contain the host name from which the message originated. If your syslog messages are not recognized by the Cisco ISE message parser, you may need to customize the message header by configuring the delimiter that proceeds the host name, thereby enabling Cisco ISE to recognize the host name and parse the message correctly. For more details about the fields in this screen, see [Syslog Customized Template Settings and Examples, on page 390](#). The customized header configuration is saved and added to the header types that are used by the parser whenever messages are received.



---

**Note** You can only customize a single header. After you customize a header, when you click **Custom Header** and create a template, only the newest configuration is saved.

---

- Step 1** Choose **Work Centers > PassiveID > Providers** and then choose **Syslog Providers** from the left panel. The Syslog Providers table is displayed, including status information for each existing client.
- Step 2** Click **Custom Header** to open the Syslog Custom Header screen.
- Step 3** In the **Paste sample syslog** field, enter an example of the header format in your syslog messages. For example, copy and paste this header from one of your messages: **<181>Oct 10 15:14:08 Cisco.com**.
- Step 4** In the **Separator** field, indicate whether words are separated by spaces or tabs.
- Step 5** In the **Position of hostname in header** field, indicate which place in the header is the host name. For example, in the header offered above, the host name is the fourth word in the header. Enter 4 to indicate this.
- The **Hostname** field displays the host name based on the details indicated in the first three fields. For example, if the header example in **Paste sample syslog** is as follows:
- ```
<181>Oct 10 15:14:08 Cisco.com
```
- The separator is indicated as **Space** and the **Position of hostname in header** is entered as 4.
- The **Hostname** will automatically appear as Cisco.com, which is the fourth word in the header phrase pasted in the **Paste sample syslog** field.
- If the host name is incorrectly displayed, check the data you have entered in the **Separator** and **Position of hostname in header** fields.
- This example is as in the following screen capture:

Figure 40: Customize Syslog Headers

Syslog Custom Header ✕

If some or all of the syslogs are not being accepted, it may be because they have an uncommon header format. Define a custom header here.

Paste sample syslog *

Separator *

Position of hostname in header *

Hostname

Step 6 Click **Submit**.

The customized header configuration is saved and added to the header types that are used by the parser whenever messages are received.

Syslog Customized Template Settings and Examples

Cisco ISE enables you to customize your own syslog message templates to be parsed by the Passive ID parser. Customized templates determine the supported structures for both new and remove mapping messages. The templates should include regular expressions to define the structure for user name, IP address, MAC address and domain in order to enable the Passive ID parser to correctly identify whether the message is to add or remove user identity mapping and to correctly parse the user details.



Note Most of the pre-defined templates use regular expressions. Customized templates should also use regular expressions.

Syslog Header Parts

You can customize a single header that is recognized by the Syslog probe by configuring the delimiter that proceeds the host name.

The following table describes the different parts and fields that can be included in your customized syslog header. For more information about regular expressions, see [Table 32: Regular Expressions for Customized Templates, on page 392](#).

Table 30: Syslog Custom Header

Field	Description
Paste sample syslog	Enter an example of the header format in your syslog messages. For example, copy and paste this header: <181>Oct 10 15:14:08 Hostname Message
Separator	Indicate whether words are separated by spaces or tabs.
Position of hostname in header	Indicate which place in the header is the host name. For example, in the header offered above, the host name is the fourth word in the header. Enter 4 to indicate this.
Hostname	Displays the hostname based on the details indicated in the first three fields. For example, if the header example in Paste sample syslog is as follows: <181>Oct 10 15:14:08 Hostname Message The separator is indicated as Space and the Position of hostname in header is entered as 4. The Hostname will automatically appear as Hostname. If the host name is incorrectly displayed, check the data you have entered in the Separator and Position of hostname in header fields.

Syslog Template Parts and Descriptions for the Message Body

The following table describes the different parts and fields that can be included in your customized syslog message templates. For more information about regular expressions, see [Table 32: Regular Expressions for Customized Templates, on page 392](#).

Table 31: Syslog Template

Part	Field	Description
	Name	A unique name by which to recognize the purpose of this template.
Mapping Operations	New Mapping	A regular expression that describes the kind of mapping used with this template to add. For example, enter "logged on from" in this field to indicate a new user that has logged on to F5 VPN.
	Removed Mapping	A regular expression that describes the kind of mapping used with this template to remove. For example, enter "session disconnect" in this field to indicate a user that should be removed from ASA VPN.

Part	Field	Description
User Data	IP Address	A regular expression that indicates the IP addresses to be captured. For example, for Bluecat messages, to capture identities for users within this IP address range, enter: (on\s to\s)((?:25[0-5] 2[0-4][0-9] [01]?[0-9][0-9]?)\.){3}(?:25[0-5] 2[0-4][0-9] [01]?[0-9][0-9]?)
	User Name	A regular expression that indicates the user name format to be captured.
	Domain	A regular expression that indicates the domain to be captured.
	Mac Address	A regular expression that indicates the MAC address format to be captured.

Regular Expression Examples

In order to parse messages use regular expressions. This section offers regular expression examples in order to parse IP address, user name and add mapping messages.

For example, use regular expressions to parse the following messages:

```
<174>192.168.0.1 %ASA-4-722051: Group <DfltGrpPolicy> User <user1> IP <192.168.0.10> IPv4 Address <192.168.0.6> IPv6 address <::> assigned to session
```

```
<174>192.168.0.1 %ASA-6-713228: Group = xyz, Username = user1, IP = 192.168.0.12, Assigned private IP address 192.168.0.8 to remote user
```

The regular expressions are as defined in the following table.

Table 32: Regular Expressions for Customized Templates

Part	Regular Expression
IP address	Address <([^\s]+)> address ([^\s]+)
User name	User <([^\s]+)> Username = ([^\s]+)
Add mapping message	(%ASA-4-722051 %ASA-6-713228)

Work with Syslog Predefined Message Templates

Syslog messages have a standard structure which include a header and the message body.

The predefined templates offered by Cisco ISE are described in this section, including content details for the headers that are supported, as well as the supported body structure, based on the origin of the messages.

In addition, you can create your own templates with customized body content for sources that are not predefined in the system. The supported structure for customized templates is also described in this section. You can configure a single customized header to be used in addition to the headers predefined in the system, when parsing messages, and you can configure multiple customized templates for the message body. For more information about customizing the header, see [Customize Syslog Headers, on page 389](#). For more information about customizing the body, see [Customize the Syslog Message Body, on page 388](#).



Note Most of the predefined templates use regular expressions, and customized templates should also use regular expressions.

Message Headers

There are two header types recognized by the parser, for all message types (new and remove), for all client machines. These headers are as follows:

- <171>Host message
- <171>Oct 10 15:14:08 Host message

Once received, the header is parsed for host name, which can be IP address, hostname, or full FQDN.

Headers can also be customized. To customize your headers, see [Customize Syslog Headers, on page 389](#).

Syslog ASA VPN Pre-Defined Template

The supported syslog message format and types for ASA VPN are as described below.

Headers

Headers supported by the parser are identical for all clients, as described in [Work with Syslog Predefined Message Templates, on page 392](#).

New Mapping Body Messages

There are different ASA VPN body messages that are recognized by the parser as described in the following table.

Body Message	Parsing Example
%ASA-6-109005 Authentication succeeded for user UserA from 10.0.0.11/100 to 10.10.11.11/20 on interface eth1/1	[UserA,10.0.0.11]
%ASA-6-602303 IPSEC: An direction tunnel_type SA (SPI=spi) between local_IP and 10.0.0.11 (UserA) has been created.	
%ASA-6-721016 (device) WebVPN session for client user UserA, IP 10.0.0.11 has been created.	
%ASA-6-603104 PPTP Tunnel created, tunnel_id is number, remote_peer_ip is remote_address, ppp_virtual_interface_id is number,\ client_dynamic_ip is 10.0.0.11, ffg123 #% UserA is UserA, MPPE_key_strength is string	
%ASA-6-603106 L2TP Tunnel created, tunnel_id is number, remote_peer_ip is remote_address, ppp_virtual_interface_id is number,\ client_dynamic_ip is 10.0.0.11, UserA is user	
%ASA-6-113039 Group group User UserA IP 10.0.0.11 AnyConnect parent session started.	
%ASA-6-802001 User UserA IP 10.100.1.1 OS os_name UDID number MDM action session started.	
%ASA-6-713228: Group = xyz, UserA = xxx227, IP = 192.168.0.11, Assigned private IP address 172.16.0.11 to remote user	[UserA,172.16.0.11] Note The parsed IP address from this message type is the private IP address, as indicated in the message.
%ASA-4-722051: Group <DfltGrpPolicy> User <UserA> IP <172.16.0.12> IPv4 Address <172.16.0.21> IPv6 address <:> assigned to session	[UserA,172.16.0.12] Note The parsed IP address from this message type is the IPv4 address.

Remove Mapping Body Messages

The Remove Mapping messages supported for ASA VPN by the parser are as described in this section.

Once received, the body is parsed for user details as follows:

[UserA,10.1.1.1]

Body Message
%ASA-4-113019 Group = group, UserA = UserA, IP = 10.1.1.1, Session disconnected. Session Type: type, Duration:\ duration, Bytes xmt: count, Bytes rcv: count, Reason: reason

Body Message
%ASA-4-717052 Group group name User UserA IP 10.1.1.1 Session disconnected due to periodic certificate authentication failure. Subject Name id subject name Issuer Name id issuer name\ Serial Number id serial number
%ASA-6-602304 IPSEC: An direction tunnel_type SA (SPI=spi) between local_IP and 10.1.1.1 (UserA) has been deleted.
%ASA-6-721018 WebVPN session for client user UserA, IP 10.1.1.1 has been deleted.
%ASA-4-722049 Group group User UserA IP 10.1.1.1 Session terminated: SVC not enabled or invalid image on the ASA
%ASA-4-722050 Group group User UserA IP 10.1.1.1 Session terminated: SVC not enabled for the user.
%ASA-6-802002 User UserA IP 10.1.1.1 OS os_name UDID number MDM action session terminated.
%ASA-3-716057 Group group User UserA IP 10.1.1.1 Session terminated, no type license available.
%ASA-3-722046 Group group User UserA IP 10.1.1.1 Session terminated: unable to establish tunnel.
%ASA-4-113035 Group group User UserA IP 10.1.1.1 Session terminated: AnyConnect not enabled or invalid AnyConnect image on the ASA.
%ASA-4-716052 Group group-name User UserA IP 10.1.1.1 Pending session terminated.
%ASA-6-721018 WebVPN session for client user UserA, IP 10.1.1.1 has been deleted.

Syslog Bluecat Pre-Defined Template

The supported syslog message format and types for Bluecat are as described below.

Headers

Headers supported by the parser are identical for all clients, as described in [Work with Syslog Predefined Message Templates, on page 392](#).

New Mapping Body Messages

The messages supported for New Mapping for Bluecat syslog are as described in this section.

Once received, the body is parsed for user details as follows:

[macAddress=nn:xx:nn:ca:xx:nn,ip=172.16.0.12]

Body
Nov 7 23:37:32 xx-campus1 dhcpd: DHCPACK on 172.16.0.13 to nn:xx:nn:ca:xx:nn via 172.16.0.17

Remove Mapping Messages

There are no remove mapping messages known for Bluecat.

Syslog F5 VPN Pre-Defined Template

The supported syslog message format and types for F5 VPN are as described below.

Headers

Headers supported by the parser are identical for all clients, as described in [Work with Syslog Predefined Message Templates, on page 392](#).

New Mapping Body Messages

There are different F5 VPN body messages that are recognized by the parser as described in the following table.

Once received, the body is parsed for user details as follows:

[user=UserA,ip=172.16.0.12]

Body
Apr 10 09:33:58 Oct 2 08:28:32 abc.xyz.org security[nnnnn]: [UserA@vendor-abcr] User UserA logged on from 172.16.0.21 to \ 172.16.0.12 Sid = xyz\

Remove Mapping Messages

Currently there are no remove messages for F5 VPN that are supported.

Syslog Infoblox Pre-Defined Template

The supported syslog message format and types for Infoblox are as described below.

Headers

Headers supported by the parser are identical for all clients, as described in [Work with Syslog Predefined Message Templates, on page 392](#).

New Mapping Body Messages

There are different ASA VPN body messages that are recognized by the parser as described in the following table.

Once received, the body is parsed for user details as follows:

[macAddress= nn:xx:xx:xx:nn:nn,ip=10.0.10.100]

Body Message
Nov 15 11:37:26 user1-lnx dhcpd[3179]: DHCPACK on 10.0.0.14 to nn:xx:xx:xx:nn:nn (android-df67ddcbb1271593) via eth2 relay 10.0.0.24 lease-duration 3600
Nov 15 11:38:11 user1-lnx dhcpd[3179]: DHCPACK on 172.16.0.18 to nn:xx:xx:xx:nn:nn (DESKTOP-HUDGAAQ) via eth2 relay 172.16.0.13 lease-duration 691200 (RENEW)
Nov 15 11:38:11 192.168.0.12 dhcpd[25595]: DHCPACK to 10.0.0.11 (nn:xx:xx:xx:nn:nn) via eth1

Remove Mapping Messages

Once received, the body is parsed for user details as follows:

- If MAC address is included:
[00:0c:29:a2:18:34,10.0.10.100]
- If MAC address is not included:
[10.0.10.100]

Body Message
07-11-2016 23:37:32 Daemon.Info 10.0.10.2 Jul 12 10:42:26 10.0.10.2 dhcpd[26083]: DHCPRELEASE 10.0.10.100 has expired
07-11-2016 23:37:32 Daemon.Info 10.0.10.2 Jul 12 10:42:26 10.0.10.2 dhcpd[26083]: DHCPRELEASE of 10.0.10.100 from 00:0c:29:a2:18:34 \ (win10) via eth1 uid 01:00:0c:29:a2:18:34
07-11-2016 23:37:32 Daemon.Info 10.0.10.2 Jul 12 10:42:26 10.0.10.2 dhcpd[25595]: RELEASE on 10.20.31.172 to c0:ce:cd:44:4f:bd

Syslog Linux DHCPd3 Pre-Defined Template

The supported syslog message format and types for Linux DHCPd3 are as described below.

Headers

Headers supported by the parser are identical for all clients, as described in [Work with Syslog Predefined Message Templates, on page 392](#).

New Mapping Messages

There are different Linux DHCPd3 body messages that are recognized by the parser as described in the following table.

Once received, the body is parsed for user details as follows:

[macAddress=24:ab:81:ca:f2:72,ip=172.16.0.21]

Body Message
Nov 11 23:37:32 dhcpsrv dhcpd: DHCPACK on 10.0.10.100 to 00:0c:29:a2:18:34 (win10) via eth1
Nov 11 23:37:32 dhcpsrv dhcpd: DHCPACK on 10.0.10.100 (00:0c:29:a2:18:34) via eth1

Remove Mapping Body Messages

The Remove Mapping messages supported for Linux DHCPd3 by the parser are as described in this section.

Once received, the body is parsed for user details as follows:

[00:0c:29:a2:18:34 ,10.0.10.100]

Body Message
Nov 11 23:37:32 dhcpsrv dhcpd: DHCPRELEASE 10.0.10.100 has expired

Body Message

```
Nov 11 23:37:32 dhcprsv dhcpd: DHCPRELEASE of 10.0.10.100 from 00:0c:29:a2:18:34 (win10) via eth1
```

Syslog MS DHCP Pre-Defined Template

The supported syslog message format and types for MS DHCP are as described below.

Headers

Headers supported by the parser are identical for all clients, as described in [Work with Syslog Predefined Message Templates, on page 392](#).

New Mapping Body Messages

There are different MS DHCP body messages that are recognized by the parser as described in the following table.

Once received, the parser divides data by searching for the comma (,) and then messages of these formats are parsed as in the following example:

```
[macAddress=00C29912E5D,ip=10.0.10.123]
```

Body Message

```
Nov 11 23:37:32
10,07/21/16,16:55:22,Assign,10.0.10.123,win10.IDCSPAN.Local,000C29912E5D,,724476048,0,,,0x4D53465420352E30,MSFT,5,0
```

Remove Mapping Body Messages

The Remove Mapping messages supported for MS DHCP by the parser are as described in this section.

Once received, the parser divides data by searching for the comma (,) and then messages of these formats are parsed as in the following example:

```
[macAddress=00C29912E5D,ip=10.0.10.123]
```

Body Message

```
Nov 11 23:37:32
12,07/21/16,16:55:18,Release,10.0.10.123,win10.IDCSPAN.Local,000C29912E5D,,3128563632,\ 0,,,,,,,,,0
```

Syslog SafeConnect NAC Pre-Defined Template

The supported syslog message format and types for SafeConnect NAC are as described below.

Headers

Headers supported by the parser are identical for all clients, as described in [Work with Syslog Predefined Message Templates, on page 392](#).

New Mapping Body Messages

There are different SafeConnect NAC body messages that are recognized by the parser as described in the following table.

Once received, the body is parsed for user details as follows:

[user=galindk1i,p=xxxx.xx.xxx.xxd,domain=Resnet-Macs]

Body Message
Apr 10 09:33:58 nac Safe*Connect: authenticationResult xxx.xx.xxx.xxx xxx.xx.xxx.xxx UserA true Resnet-Macs TCNJ-Chain 001b63b79018 MAC

Remove Mapping Messages

Currently there are no remove messages for Safe Connect that are supported.

Syslog Aerohive Pre-Defined Templates

The supported syslog message format and types for Aerohive are as described below.

Headers

Headers supported by the parser are identical for all clients, as described in [Work with Syslog Predefined Message Templates, on page 392](#).

New Mapping Body Messages

There are different Aerohive body messages that are recognized by the parser as described in the following table.

Details parsed from the body include user name and IP address. The regular expression used for parsing is as in the following examples:

- New mapping-auth\
:
- IP-ip ([A-F0-9a-f:.]+)
- User name-UserA ([a-zA-Z0-9_]+)

Once received, the body is parsed for user details as follows:

[UserA,10.5.50.52]

Body Message
2013-04-01 14:06:05 info ah auth: Station 1cab:a7e6:cf7f ip 10.5.50.52 UserA UserA

Remove Mapping Messages

Currently the system does not support remove mapping messages from Aerohive.

Syslog Blue Coat Pre-Defined Templates—Main Proxy, Proxy SG, Squid Web Proxy

The system supports the following message types for Blue Coat:

- BlueCoat Main Proxy
- BlueCoat Proxy SG
- BlueCoat Squid Web Proxy

The supported syslog message format and types for Bluecoat messages are as described below.

Headers

Headers supported by the parser are identical for all clients, as described in [Work with Syslog Predefined Message Templates](#), on page 392.

New Mapping Body Messages

There are different Blue Coat body messages that are recognized by the parser as described in the following table.

Once received, the body is parsed for user details as follows:

[UserA,192.168.10.24]

Body Message (this example is taken from a BlueCoat Proxy SG message)
2016-09-21 23:05:33 58 10.0.0.1 UserA - - PROXIED "none" http://www.example.com/ 200 TCP_MISS GET application/json;charset=UTF-8 http site.api.example.com 80 /apis/v2/scoreboard/header?rand=1474499133503 - "Mozilla/5.0 (Windows NT 10.0; Win64; x64) AppleWebKit/537.36 (KHTML, like Gecko) Chrome/46.0.2486.0 Safari/537.36 Edge/13.10586" 192.168.10.24 7186 708 - "unavailable

The following table describes the different regular expression structures used per client for new mapping messages.

Client	Regular expressions
BlueCoat Main Proxy	New mapping (TCP_HIT TCP_MEM){1} IP \s(?:[0-9]{1,3}){3}(?:[0-9]{1,3})?(?:[a-zA-Z0-9]{1,4}){1,2}([a-zA-Z0-9]{1,4})\s User name \s-\s([a-zA-Z0-9_+])\s-\s
BlueCoat Proxy SG	New mapping (\sPROXIED){1} IP \s(?:[0-9]{1,3}){3}(?:[0-9]{1,3})?(?:[a-zA-Z0-9]{1,4}){1,2}([a-zA-Z0-9]{1,4})\s User name \s[0-9]{1,3}\.[0-9]{1,3}\.[0-9]{1,3}\.[0-9]{1,3}\s([a-zA-Z0-9_+])\s-

Client	Regular expressions
BlueCoat Squid Web Proxy	<p>New mapping</p> <p>(TCP_HIT TCP_MEM){1}</p> <p>IP</p> <p>\((?:09 13 309 13)(?:[a-zA-Z0-9]{4} (12 17)[a-zA-Z0-9]{4})\)TCP</p> <p>User name</p> <p>\s([a-zA-Z0-9\._]+)\s -\s/</p>

Remove Mapping Messages

Remove mapping messages are supported for Blue Coat clients, though no examples are currently available. The following table describes the different known regular expression structure examples used per client for remove mapping messages.

Client	Regular expressions
BlueCoat Main Proxy	(TCP_MISS TCP_NC_MISS){1}
BlueCoat Proxy SG	No example currently available.
BlueCoat Squid Web Proxy	(TCP_MISS TCP_NC_MISS){1}

Syslog ISE and ACS Pre-Defined Templates

When listening to ISE or ACS clients, the parser receives the following message types:

- **Pass authentication:** When the user is authenticated by ISE or ACS, the pass authentication message is issued notifying that authentication succeeded, and including user details. The message is parsed and the user details and session ID are saved from this message.
- **Accounting start and accounting update messages (new mapping):** The accounting start or accounting update message is parsed with the user details and session ID that were saved from the Pass Authentication message and then the user is mapped.
- **Accounting stop (remove mapping):** The user mapping is deleted from the system.

The supported syslog message format and types for ISE and ACS are as described below.

Pass Authentication Messages

The following messages are supported for Pass Authentication.

- **Header**

```
<181>Sep 13 10:51:41 Server logTag messageId totalFragments currentFragments message
```

For example: <181>Sep 13 10:51:41 Positron CISE_PassiveID 0000005255 1 0 message

- **Body**

```
Passed-Authentication 000011 1 0 2016-05-09 12:48:11.011 +03:00 0000012435 5200 NOTICE
Passed-Authentication: Authentication succeeded, ConfigVersionId=104, Device IP Address=10.0.0.12,
```

DestinationIPAddress=10.0.0.18, DestinationPort=1812, UserA=UserA, Protocol=Radius, RequestLatency=45, NetworkDeviceName=DefaultNetworkDevice, User-Name=UserA, NAS-IP-Address=10.0.0.1, Session-Timeout=90, Calling-Station-ID=, cisco-av-pair=audit-session-id=5

- **Parsing Example**

User name and session ID only are parsed.

[UserA,5]

Accounting Start/Update (New Mapping) Messages

The following messages are supported for New Mapping.

- **Header**

<181>Sep 13 10:51:41 Server logTag messageId totalFragments currentFragments message

For example: <181>Sep 13 10:51:41 Positron CISE_PassiveID 0000005255 1 0 message

- **Body**

CISE_RADIUS_Accounting 000011 1 0 2016-05-09 12:53:52.823 +03:00 0000012451 3000 NOTICE Radius-Accounting: RADIUS Accounting start request, ConfigVersionId=104, Device IP Address=10.0.0.12, RequestLatency=12, NetworkDeviceName=DefaultNetworkDevice, User-Name=UserA, NAS-IP-Address=10.0.0.1, Framed-IP-Address=10.0.0.16, Session-Timeout=90, Calling-Station-ID=, Acct-Status-Type=Start, Acct-Session-Id=6, cisco-av-pair=audit-session-id=5

- **Parsing Example**

Parsed details include user name, and framed IP address, as well as the MAC address if it is included in the message.

[UserA,10.0.0.16]

Remove Mapping Messages

The following messages are supported for Remove Mapping.

- **Header**

<181>Sep 13 10:51:41 Server logTag messageId totalFragments currentFragments message

For example: <181>Sep 13 10:51:41 Positron CISE_PassiveID 0000005255 1 0 message

- **Body**

2016-05-09 12:56:27.274 +03:00 0000012482 3001 NOTICE Radius-Accounting: RADIUS Accounting stop request, ConfigVersionId=104, Device IP Address=10.0.0.17, RequestLatency=13, NetworkDeviceName=DefaultNetworkDevice, User-Name=UserA, NAS-IP-Address=10.0.0.1, Framed-IP-Address=10.0.0.16, Session-Timeout=90, Calling-Station-ID=, Acct-Status-Type=Stop, Acct-Session-Id=104, cisco-av-pair=audit-session-id=5

- **Parsing Example**

Parsed details include user name, and framed IP address, as well as the MAC address if it is included in the message.

[UserA,10.0.0.16]

Syslog Lucent QIP Pre-Defined Template

The supported syslog message format and types for Lucent QIP are as described below.

Headers

Headers supported by the parser are identical for all clients, as described in [Work with Syslog Predefined Message Templates, on page 392](#).

New Mapping Body Messages

There are different Lucent QIP body messages that are recognized by the parser as described in the following table.

The regular expression structure for these messages is as follows:

DHCP_GrantLease|DHCP_RenewLease

Once received, the body is parsed for user details as follows:

[00:0C:29:91:2E:5D,10.0.0.11]

Body Message
DHCP:subtype=0:Single:\$IGNORE_N\$ DHCP_GrantLease: Host=\$HOSTNAME\$ P=10.0.0.11 MAC=00:0C:29:91:2E:5D
DHCP:subtype=0:Single:\$IGNORE_N\$ DHCP_RenewLease: Host=\$HOSTNAME\$ P=10.0.0.11 MAC=00:0C:29:91:2E:5D

Remove Mapping Body Messages

The regular expression structure for these messages is as follows:

Delete Lease|DHCP Auto Release:

Once received, the body is parsed for user details as follows:

[10.0.0.11]

Body Message
DHCP:subtype=0:Single:\$IGNORE_N\$ Delete Lease: IP=10.0.0.11 \$IGNORE_N\$
DHCP:subtype=0:Single:\$IGNORE_N\$ DHCP Auto Release: IP=10.0.0.11 \$IGNORE_N\$

Filter Passive Identity Services

You can filter certain users, based on their name or IP address. For example, if you have an administrator from IT services who logs in to an endpoint in order to assist the regular user with that endpoint, you can filter out the administrator activity so it does not appear in Live Sessions, but rather only the regular user of that endpoint will appear. The Live Session shows Passive Identity service components that are not filtered out by the Mapping Filters. You can add as many filters as needed. The “OR” logic operator applies between filters. If both the fields are specified in a single filter, the “AND” logic operator applies between these fields.

Step 1 Choose **Work Centers > PassiveID > Providers** and then from the left panel choose **Mapping Filters**.

- Step 2** Choose **Providers** > **Mapping Filters**.
- Step 3** Click **Add**, enter the Username and or IP address of the user you want to filter and click **Submit**.
- Step 4** To view the non-filtered users that are currently logged into the Monitoring session directory, choose **Operations** > **RADIUS LiveLog**.

Endpoint Probe

In addition to the customized providers that you can configure the Endpoint probe is enabled in ISE when the Passive Identity service is activated and always runs in the background. The Endpoint probe periodically checks whether each specific user is still logged in to the system.



Note In order to ensure Endpoint runs in the background, you must first configure an initial Active Directory join point and ensure you choose to **Store Credentials**. For more information about configuring the Endpoint probe, see [Work with the Endpoint Probe, on page 405](#).

To manually check for endpoint status go to **Live Sessions**, from the **Actions** column, click **Show Actions** and choose **Check current user**, as in the following figure.

Figure 41: Check Current User

Session Status	Action	Endpoint ID	Identity
enticated	Show Actions		Administra
enticated	Show Actions		istern
enticated	Show Actions	10.56.53.179	Administra
enticated	Show Actions	10.56.63.172	Administra
enticated	Show Actions	10.56.53.204	Administra
enticated	Show Actions	10.56.53.197	Administra

For more information about endpoint user status, and manually running the check, see [RADIUS Live Sessions, on page 1152](#).

When the Endpoint probe recognizes that a user has connected, if 4 hours have passed since the last time the session was updated for the specific endpoint, it checks whether that user is still logged in and collects the following data:

- MAC address
- Operating system version

Based on the this check, the probe does the following:

- When the user is still logged in, the probe updates Cisco ISE with the status Active User.
- When the user has logged out, the session state is updated as Terminated and fifteen minutes later, the user is removed from the Session Directory.
- When the user cannot be contacted, for example, when a firewall prevents contact or the endpoint has shut down, the status is updated as Unreachable and the Subscriber policy will determine how to handle the user session. The endpoint will remain in the Session Directory.

Work with the Endpoint Probe

Before you begin

Create and enable Endpoint probes based on subnet ranges. One Endpoint probe can be created per PSN. To work with Endpoint probes, first ensure you have configured the following:

- Endpoints must have network connectivity to port 445.
- From ISE, configure an initial Active Directory join point and ensure you select **Select Credentials** when prompted. For more information about join points, see [Active Directory as a Probe and a Provider, on page 363](#).



Note In order to ensure Endpoint runs in the background, you must first configure an initial Active Directory join point, which enables the Endpoint probe to run even when the Active Directory probe is not fully configured.

-
- Step 1** Choose **Work Centers > Passive ID > Providers** and then choose **Endpoint Probes**.
- Step 2** Click **Add** to create a new Endpoint probe.
- Step 3** Complete the mandatory fields, ensuring you select **Enable** from the **Status** field, and click **Submit**. See [Endpoint Probe Settings, on page 405](#) for more information.
-

Endpoint Probe Settings

Create a single Endpoint probe per PSN, based on subnet ranges. If you have multiple PSNs in your deployment, then you can allot each PSN for a separate set of subnets.

Table 33: Endpoint Probes Settings

Field Name	Description
Name	Enter a unique name by which to identify the use of this probe.
Description	Enter a unique description that explains the use for this probe.
Status	Choose Enable to activate this probe.

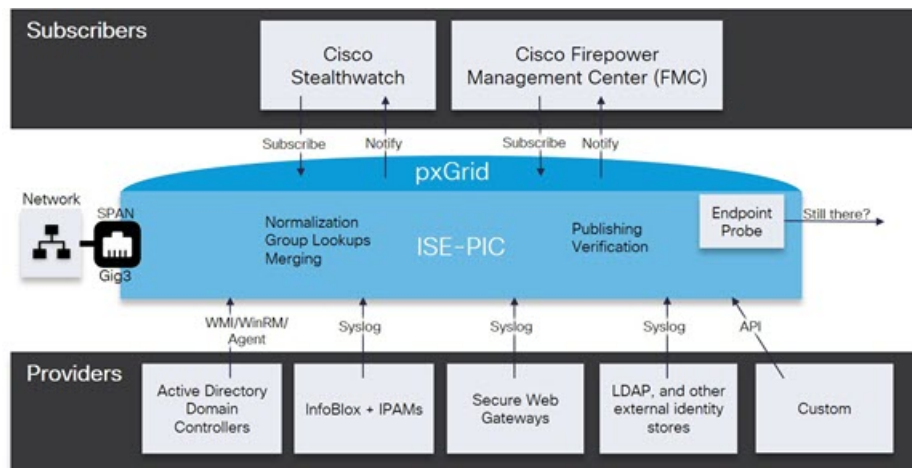
Field Name	Description
Host Name	Choose a PSN for this probe from the list of available PSNs in your deployment.
Subnets	<p>Enter the subnet range for the group of endpoints that should be checked by this probe. Use standard subnet mask ranges and separate subnet addresses with commas.</p> <p>For example: 10.56.14.111/32,2.55.2.0/16,2.2.3.0/16,1.2.3.4/32</p> <p>Each range must be unique and separate from all other ranges. For example, you cannot enter the following ranges for the same probe because they overlap with each other: 2.2.2.0/16,2.2.3.0/16</p>

Subscribers

The Passive Identity services use Cisco pxGrid services to deliver authenticated user identities that are collected from various providers and stored by the Cisco ISE session directory, to other network systems such as Cisco Stealthwatch or Cisco Firepower Management Center (FMC).

In the following figure, the pxGrid node collects user identities from external providers. Those identities are parsed, mapped and formatted. pxGrid takes those formatted user identities and sends them to Passive Identity service subscribers.

Figure 42: Passive Identity Service Flow



Subscribers connected to Cisco ISE must register to use the pxGrid services. Subscribers should adopt the pxGrid Client Library available from Cisco through the pxGrid SDK to become the clients. A subscriber can log in to pxGrid using a unique name and certificate-based mutual authentication. Once they have sent a valid certificate, Cisco pxGrid subscribers are automatically approved by ISE.

Subscribers can connect to either a configured pxGrid server hostname or an IP Address. We recommend that you use hostname to avoid unnecessary errors, particularly to ensure the DNS queries work properly. Capabilities are information topics or channels that are created on pxGrid for subscribers to publish and

subscribe. In Cisco ISE, only SessionDirectory and IdentityGroup are supported. You can view capability information that is available from the publisher through publish, directed query, or bulk download query, by navigating to **Subscribers** in the **Capabilities** tab.

To enable subscribers to receive information from ISE, you must:

1. Optionally, generate a certificate from the subscriber's side.
2. [Generate pxGrid Certificates for Subscribers, on page 407](#) from the PassiveID work center.
3. [Enable Subscribers, on page 408](#). Either perform this step, or automatically enable approvals, in order to allow subscribers to receive user identities from ISE. See [Configure Subscriber Settings, on page 409](#).

Generate pxGrid Certificates for Subscribers

Before you begin

You can generate certificates for pxGrid subscribers in order to guarantee mutual trust between pxGrid and the subscribers, thereby enabling user identities to be passed from ISE to the subscribers. To perform the following task, you must be a Super Admin or System Admin.

Step 1 Choose **Work Centers > PassiveID > Subscribers** and go to the **Certificates** tab.

Step 2 Select one of the following options from the **I want to** drop-down list:

- **Generate a single certificate without a certificate signing request:** You must enter the Common Name (CN) if you select this option. In the Common Name field, enter the pxGrid FQDN which includes pxGrid as the prefix. For example, www.pxgrid-ise.ise.net. Or, alternatively, use wildcards. For example, *.ise.net
- **Generate a single certificate with a certificate signing request:** You must enter the Certificate Signing Request details if you select this option.
- **Generate bulk certificates:** You can upload a CSV file that contains the required details.
- **Download Root Certificate Chain:** Download the ISE public root certificates in order to add them to the pxGrid client's trusted certificate store. The ISE pxGrid node only trusts the newly signed pxGrid client certificate and vice-versa, eliminating the need for outside certificate authorities.

Step 3 (optional) You can enter a description for this certificate.

Step 4 View or edit the pxGrid Certificate template on which this certificate is based. Certificate templates contain properties that are common to all certificates issued by the Certificate Authority (CA) based on that template. The certificate template defines the Subject, Subject Alternative Name (SAN), key type, key size, SCEP RA profile that must be used, validity period of the certificate, and the extended key usage (EKU) that specifies whether the certificate has to be used for client or server authentication or both. The internal Cisco ISE CA (ISE CA) uses a certificate template to issue certificates based on that template. To edit this template, choose **Administration > Certificates > Certificate Authority > Certificate Templates**.

Step 5 Specify the Subject Alternative Name (SAN). You can add multiple SANs. The following options are available:

- **FQDN:** Enter the fully qualified domain name of the ISE node. For example www.isepic.ise.net. Or, alternatively, use wildcards for the FQDN. For example, *.ise.net

An additional line can be added for FQDN in which the pxGrid FQDN can also be entered. This should be identical to the FQDN you used in the Common Name field.

- **IP address:** Enter the IP address of the ISE node to be associated with the certificate. This information must be entered if the subscriber uses IP addresses instead of an FQDN.

Note This field is not displayed if you have selected the Generate Bulk Certificate option.

Step 6 Select one of the following options from the **Certificate Download Format** drop-down list:

- **Certificate in Private Enhanced Electronic Mail (PEM) format, key in PKCS8 PEM format (including certificate chain):** The root certificate, the intermediate CA certificates, and the end entity certificate are represented in the PEM format. PEM formatted certificate are BASE64-encoded ASCII files. Each certificate starts with the "-----BEGIN CERTIFICATE-----" tag and ends with the "-----END CERTIFICATE-----" tag. The end entity's private key is stored using PKCS* PEM. It starts with the "-----BEGIN ENCRYPTED PRIVATE KEY-----" tag and ends with the "-----END ENCRYPTED PRIVATE KEY-----" tag.
- **PKCS12 format (including certificate chain; one file for both the certificate chain and key):** A binary format to store the root CA certificate, the intermediate CA certificate, and the end entity's certificate and private key in one encrypted file.

Step 7 Enter a certificate password.

Step 8 Click **Create**.

Enable Subscribers

You must perform this task, or alternatively automatically enable approvals, in order to allow subscribers to receive user identities from Cisco ISE. See [Configure Subscriber Settings, on page 409](#).

Before you begin

- Enable the pxGrid persona on at least one node to view the requests from the Cisco pxGrid clients.
- Enable Passive Identity Service. For more information, see [Easy Connect, on page 357](#).

Step 1 Choose **Work Centers > PassiveID > Subscribers** and ensure you are viewing the **Clients** tab.

Step 2 Check the checkbox next to the subscriber and click **Approve**.

Step 3 Click **Refresh** to view the latest status.

View Subscriber Events from Live Logs

The Live Logs page displays all the Subscriber events. Event information includes the subscriber and capability names along with the event type and timestamp.

Navigate to **Subscribers** and select the **Live Log** tab to view the list of events. You can also clear the logs and resynchronize or refresh the list.

Configure Subscriber Settings

Before you begin

To perform the following task, you must be a Super Admin or System Admin.

Step 1 Choose **Administration > pxGrid Services > Settings**.

Step 2 Select the following options based on your requirements:

- **Automatically Approve New Accounts:** Check this checkbox to automatically approve the connection requests from new pxGrid clients.
- **Allow Password Based Account Creation:** Check this checkbox to enable username/password based authentication for pxGrid clients. If this option is enabled, the pxGrid clients cannot be automatically approved.

A pxGrid client can register itself with the pxGrid controller by sending the username via REST API. The pxGrid controller generates a password for the pxGrid client during client registration. The administrator can approve or deny the connection request.

Step 3 Click **Save**.

Monitoring and Troubleshooting Service in PassivID Work Center

Learn about how you can manage PassiveID Work Center with monitoring, troubleshooting and reporting tools.

- [RADIUS Live Sessions, on page 1152](#)
- See the Reports section in [Cisco ISE Reports, on page 897](#)
- [TCP Dump Utility to Validate Incoming Traffic, on page 883](#)

LDAP

Lightweight Directory Access Protocol (LDAP) is a networking protocol defined by RFC 2251 for querying and modifying directory services that run on TCP/IP. LDAP is a lightweight mechanism for accessing an X.500-based directory server.

Cisco ISE integrates with an LDAP external database, which is also called an identity source, by using the LDAP protocol.

LDAP Directory Service

LDAP directory service is based on a client-server model. A client starts an LDAP session by connecting to an LDAP server and sending operation requests to the server. The server then sends its responses. One or more LDAP servers contain data from the LDAP directory tree or the LDAP backend database.

The directory service manages a directory, which is a database that holds information. Directory services use a distributed model for storing information, and that information is usually replicated between directory servers.

An LDAP directory is organized in a simple tree hierarchy and can be distributed among many servers. Each server can have a replicated version of the total directory, which is synchronized periodically.

An entry in the tree contains a set of attributes, where each attribute has a name (an attribute type or attribute description) and one or more values. The attributes are defined in a schema.

Each entry has a unique identifier: its distinguished name (DN). This name contains the relative distinguished name (RDN), which is constructed from attributes in the entry, followed by the DN of the parent entry. You can think of the DN as a full filename, and the RDN as a relative filename in a folder.

Multiple LDAP Instances

By creating more than one LDAP instance with different IP addresses or port settings, you can configure Cisco ISE to authenticate using different LDAP servers or different databases on the same LDAP server. Each primary server IP address and port configuration, along with the secondary server IP address and port configuration, forms an LDAP instance that corresponds to one Cisco ISE LDAP identity source instance.

Cisco ISE does not require that each LDAP instance correspond to a unique LDAP database. You can have more than one LDAP instance set to access the same database. This method is useful when your LDAP database contains more than one subtree for users or groups. Because each LDAP instance supports only one subtree directory for users and one subtree directory for groups, you must configure separate LDAP instances for each user directory and group directory subtree combination for which Cisco ISE submits authentication requests.

LDAP Failover

Cisco ISE supports failover between a primary LDAP server and a secondary LDAP server. A failover occurs when an authentication request fails because Cisco ISE could not connect to an LDAP server because it is down or is otherwise unreachable.

If you establish failover settings and the first LDAP server that Cisco ISE attempts to contact cannot be reached, Cisco ISE always attempts to contact a second LDAP server. If you want Cisco ISE to use the first LDAP server again, you must enter a value in the Failback Retry Delay text box.



Note Cisco ISE always uses the primary LDAP server to obtain groups and attributes for use in authorization policies from the Admin portal, so the primary LDAP server must be accessible when you configure these items. Cisco ISE uses the secondary LDAP server only for authentications and authorizations at run time, according to the failover configuration.

LDAP Connection Management

Cisco ISE supports multiple concurrent LDAP connections. Connections are opened on demand at the time of the first LDAP authentication. The maximum number of connections is configured for each LDAP server. Opening connections in advance shortens the authentication time. You can set the maximum number of connections to use for concurrent binding connections. The number of open connections can be different for

each LDAP server (primary or secondary) and is determined based on the maximum number of administration connections configured for each server.

Cisco ISE retains a list of open LDAP connections (including the binding information) for each LDAP server that is configured in Cisco ISE. During the authentication process, the connection manager attempts to find an open connection from the pool. If an open connection does not exist, a new one is opened.

If the LDAP server closed the connection, the connection manager reports an error during the first call to search the directory, and tries to renew the connection. After the authentication process is complete, the connection manager releases the connection.

LDAP User Authentication

You can configure LDAP as an external identity store. Cisco ISE uses plain password authentication. User authentication includes:

- Searching the LDAP server for an entry that matches the username in the request.
- Checking the user password with the one that is found in the LDAP server.
- Retrieving a group's membership information for use in policies.
- Retrieving values for specified attributes for use in policies and authorization profiles.

To authenticate a user, Cisco ISE sends a bind request to the LDAP server. The bind request contains the DN and password of the user in clear text. If the DN and password of the user match the username and password in the LDAP directory, then the user is authenticated.

When Active Directory is used as LDAP, UPN names are used for user authentication. When Sun ONE Directory Server is used as LDAP, SAM names are used for user authentication



Note

- Cisco ISE sends two searchRequest messages for every user authentication. This does not impact Cisco ISE authorization or network performance. The second LDAP request is to make sure the Cisco ISE is talking to the right identity.
- Cisco ISE as a DNS client, uses only the first IP returned in the DNS response to perform the LDAP bind.

We recommend that you protect the connection to the LDAP server using Secure Sockets Layer (SSL).



Note

Password change is supported for LDAP only if there are remaining grace logins for the account after the password has expired. If password change is successful, the LDAP server's bindResponse is LDAP_SUCCESS, and includes the remaining grace logins control field in the bindResponse message. If the bindResponse message contains any additional control fields (other than remaining grace logins), Cisco ISE might not be able to decode the message.

LDAP Group and Attribute Retrieval for Use in Authorization Policies

Cisco ISE can authenticate a subject (user or host) against an LDAP identity source by performing a bind operation on the directory server to find and authenticate the subject. After a successful authentication, Cisco ISE can retrieve groups and attributes that belong to the subject whenever they are required. You can configure the attributes to retrieve in the Cisco ISE Admin portal by choosing **Administration > Identity Management > External Identity Sources > LDAP**. These groups and attributes can be used by Cisco ISE to authorize the subject.

To authenticate a user or query the LDAP identity source, Cisco ISE connects to the LDAP server and maintains a connection pool.

You should note the following restrictions on group memberships when Active Directory is configured as an LDAP store:

- Users or computers must be direct members of the group defined in the policy conditions to match the policy rule.
- The defined group may not be a user's or computer's primary group. This restriction is applicable only when Active Directory is configured as an LDAP store.

LDAP Group Membership Information Retrieval

For user authentication, user lookup, and MAC address lookup, Cisco ISE must retrieve group membership information from LDAP databases. LDAP servers represent the association between a subject (a user or a host) and a group in one of the following ways:

- Groups Refer to Subjects: The group objects contain an attribute that specifies the subject. Identifiers for subjects can be sourced in the group as the following:
 - Distinguished names
 - Plain usernames
- Subjects Refer to Groups: The subject objects contain an attribute that specifies the group to which they belong.

LDAP identity sources contain the following parameters for group membership information retrieval:

- Reference direction: This parameter specifies the method to use when determining group membership (either groups to subjects or subjects to groups).
- Group map attribute: This parameter indicates the attribute that contains group membership information.
- Group object class: This parameter determines that certain objects are recognized as groups.
- Group search subtree: This parameter indicates the search base for group searches.
- Member type option: This parameter specifies how members are stored in the group member attribute (either as DNs or plain usernames).

LDAP Attributes Retrieval

For user authentication, user lookup, and MAC address lookup, Cisco ISE must retrieve the subject attributes from LDAP databases. For each instance of an LDAP identity source, an identity source dictionary is created. These dictionaries support attributes of the following data types:

- String
- Unsigned integer 32
- IPv4 address

For unsigned integers and IPv4 attributes, Cisco ISE converts the strings that it has retrieved to the corresponding data types. If conversion fails or if no values are retrieved for the attributes, Cisco ISE logs a debug message, but the authentication or lookup process does not fail.

You can optionally configure default values for the attributes that Cisco ISE can use when the conversion fails or when Cisco ISE does not retrieve any values for the attributes.

LDAP Certificate Retrieval

If you have configured certificate retrieval as part of user lookup, then Cisco ISE must retrieve the value of the certificate attribute from LDAP. To retrieve the value of the certificate attribute from LDAP, you must have previously configured the certificate attribute in the list of attributes to be accessed while configuring an LDAP identity source.

Errors Returned by the LDAP Server

The following errors can occur during the authentication process:

- Authentication Errors—Cisco ISE logs authentication errors in the Cisco ISE log files.

Possible reasons for an LDAP server to return binding (authentication) errors include the following:

- Parameter errors—Invalid parameters were entered
- User account is restricted (disabled, locked out, expired, password expired, and so on)
- Initialization Errors—Use the LDAP server timeout settings to configure the number of seconds that Cisco ISE should wait for a response from an LDAP server before determining that the connection or authentication on that server has failed.

Possible reasons for an LDAP server to return an initialization error are:

- LDAP is not supported.
- The server is down.
- The server is out of memory.
- The user has no privileges.
- Administrator credentials are configured incorrectly.

The following errors are logged as external resource errors, indicating a possible problem with the LDAP server:

- A connection error occurred
- The timeout expired
- The server is down
- The server is out of memory

The following error is logged as an Unknown User error:

- A user does not exist in the database

The following error is logged as an Invalid Password error, where the user exists, but the password sent is invalid:

- An invalid password was entered

LDAP User Lookup

Cisco ISE supports the user lookup feature with an LDAP server. This feature allows you to search for a user in the LDAP database and retrieve information without authentication. The user lookup process includes the following actions:

- Searching the LDAP server for an entry that matches the username in the request
- Retrieving a user's group membership information for use in policies
- Retrieving values for specified attributes for use in policies and authorization profiles

LDAP MAC Address Lookup

Cisco ISE supports the MAC address lookup feature. This feature allows you to search for a MAC address in the LDAP database and retrieve information without authentication. The MAC address lookup process includes the following actions:

- Searching the LDAP server for an entry that matches the MAC address of the device
- Retrieving a MAC Address group information for the device for use in policies
- Retrieving values for specified attributes for use in policies

Add LDAP Identity Sources

Before you begin

- To perform the following task, you must be a Super Admin or System Admin.
- Cisco ISE always uses the primary LDAP server to obtain groups and attributes for use in authorization policies. Therefore, your primary LDAP server must be reachable when you configure these items.

Step 1 Choose **Administration > Identity Management > External Identity Sources > LDAP > Add**.

Step 2 Enter the values.

Step 3 Click **Submit** to create an LDAP instance.

Configure LDAP Schema

Step 1**Step 2**

Select the LDAP instance.

Step 3

Click the **General** tab.

Step 4

Click the drop-down arrow near the **Schema** option.

Step 5


Select the required schema from the **Schema** drop-down list. You can select the **Custom** option to update the attributes based on your requirements.

Predefined attributes are used for the built-in schema, such as Active Directory, Sun directory Server, Novell eDirectory. If you edit the attributes of the predefined schema, Cisco ISE automatically creates a custom schema.

Configure Primary and Secondary LDAP Servers

After you create an LDAP instance, you must configure the connection settings for the primary LDAP server. Configuring a secondary LDAP server is optional.

Step 1

ChooseIn the Cisco ISE GUI, click the **Menu** icon () and choose **Administration** > **Identity Management** > **External Identity Sources** > **LDAP**.

Step 2

Check the check box next to the LDAP instance that you want to edit and click **Edit**.

Step 3

Click the **Connection** tab to configure the primary and secondary servers.

Step 4

Enter the values as described in LDAP Identity Source Settings.

Step 5


Click **Submit** to save the connection parameters.

Enable Cisco ISE to Obtain Attributes from the LDAP Server

For Cisco ISE to obtain user and group data from an LDAP server, you must configure LDAP directory details in Cisco ISE. For LDAP identity source, the following three searches are applicable:

- Search for all groups in group subtree for administration
 - Search for user in subject subtree to locate user
 - Search for groups in which the user is a member
-

Step 1

ChooseIn the Cisco ISE GUI, click the **Menu** icon () and choose **Administration** > **Identity Management** > **External Identity Sources** > **LDAP**.

Step 2

Check the check box next to the LDAP instance that you want to edit and click **Edit**.

Step 3

Click the **Directory Organization** tab.

Step 4


Enter the values as described in LDAP Identity Source Settings.

Step 5

Click **Submit** to save the configuration.

Retrieve Group Membership Details from the LDAP Server

You can add new groups or select groups from the LDAP directory.

-
- Step 1** Choose In the Cisco ISE GUI, click the **Menu** icon () and choose **Administration > Identity Management > External Identity Sources > LDAP**.
- Step 2** Check the check box next to the LDAP instance that you want to edit and click **Edit**.
- Step 3** Click the **Groups** tab.
- Step 4** Choose **Add > Add Group** to add a new group or choose **Add > Select Groups From Directory** to select the groups from the LDAP directory.
- If you choose to add a group, enter a name for the new group.
 - If you are selecting from the directory, enter the filter criteria, and click **Retrieve Groups**. Your search criteria can contain the asterisk (*) wildcard character.
- Step 5** Check the check boxes next to the groups that you want to select and click **OK**.
The groups that you have selected will appear in the Groups page.
- Step 6** Click **Submit** to save the group selection.
-



Note Active Directory built-in groups are not supported when Active Directory is configured as LDAP Identity Store in Cisco ISE.

Retrieve User Attributes from the LDAP Server

You can obtain user attributes from the LDAP server for use in authorization policies.

-
- Step 1** Choose **Administration > Identity Management > External Identity Sources > LDAP**.
- Step 2** Check the check box next to the LDAP instance that you want to edit and click **Edit**.
- Step 3** Click the **Attributes** tab.
- Step 4** Choose **Add > Add Attribute** to add a new attribute or choose **Add > Select Attributes From Directory** to select attributes from the LDAP server.
- If you choose to add an attribute, enter a name for the new attribute.
 - If you are selecting from the directory, enter an example user and click **Retrieve Attributes** to retrieve the user's attributes. You can use the asterisk (*) wildcard character.
- Step 5** Check the check boxes next to the attributes that you want to select, then click **OK**.
- Step 6** Click **Submit** to save the attribute selections.
-

Enable Secure Authentication with LDAP Identity Source

When you choose the Secure Authentication option in the LDAP configuration page, Cisco ISE uses SSL to secure communication with the LDAP identity source. Secure connection to LDAP identity source is established using:

- SSL tunnel: Using SSL v3 or TLS v1 (the strongest version supported by the LDAP server)
- Server authentication (authentication of LDAP server): Certificate based
- Client authentication (authentication of Cisco ISE): None (Administrator bind is used inside the SSL tunnel)
- Cipher suites: All cipher suites supported by Cisco ISE

We recommend that you use TLS v1 with the strongest encryption and ciphers that Cisco ISE supports.

To enable Cisco ISE to communicate securely with the LDAP identity source:

Before you begin

- Cisco ISE must be connected to an LDAP server
- TCP port 636 should be open

-
- Step 1** Import the full Certificate Authority (CA) chain of the CA that issued the server certificate to the LDAP server in to Cisco ISE (**Administration** > **System** > **Certificates** > **Trusted Certificates**).
- The full CA chain refers to the root CA and intermediate CA certificates; not the LDAP server certificate.
- Step 2** Configure Cisco ISE to use secure authentication when communicating with the LDAP identity source (**Administration** > **Identity Management** > **External Identity Sources** > **LDAP**; be sure to check the Secure Authentication check box in the Connection Settings tab).
- Step 3** Select the root CA certificate in the LDAP identity store.
-

ODBC Identity Source

You can use an Open Database Connectivity (ODBC)-compliant database as an external identity source to authenticate users and endpoints. ODBC identity source can be used in an identity store sequence and for Guest and Sponsor authentications. It can also be used for BYOD flow.

The following database engines are supported:

- MySQL
- Oracle
- PostgreSQL
- Microsoft SQL Server
- Sybase

Configuring Cisco ISE to authenticate against an ODBC-compliant database does not affect the configuration of the database. To manage your database, refer to your database documentation.



Note Cisco ISE does not support encryption with ODBC. Hence, ODBC connections are not secured.

Credential Check for ODBC Database

Cisco ISE supports three different types of credential check for an ODBC database. You must configure appropriate SQL stored procedure for each credential check type. Cisco ISE uses the stored procedure to query the appropriate tables in the ODBC database and receive the output parameters or recordset from the ODBC database. The database can return a recordset or a set of named parameters in response to an ODBC query.

The password can be stored in an ODBC database in clear text or encrypted format. The stored procedure can decrypt it back to clear text when it is called by Cisco ISE.

Credential Check Type	ODBC Input Parameters	ODBC Output Parameters	Credential Check	Authentication Protocols
Plain text password authentication in ODBC database	Username Password	Result Group Account Info Error string	If the username and password are matched, relevant user information is returned.	PAP EAP-GTC (as inner method of PEAP or EAP-FAST) TACACS
Plain text password fetching from ODBC database	Username	Result Group Account Info Error string Password	If the username is found, its password and relevant user information is returned by the stored procedure. Cisco ISE calculates the password hash based on the authentication method and compares it with the one that is received from the client.	CHAP MSCHAPv1/v2 EAP-MD5 LEAP EAP-MSCHAPv2 (as inner method of PEAP or EAP-FAST) TACACS
Lookup	Username	Result Group Account Info Error string	If the username is found, relevant user information is returned.	MAB Fast reconnect of PEAP, EAP-FAST, and EAP-TTLS



Note If ODBC is used as the lookup source for authorization, ensure that the ODBC database and incoming request MAB format are same.

The groups that are returned in the output parameters are not used in Cisco ISE. Only the groups that are retrieved by the Fetch Groups stored procedure are used in Cisco ISE. The account information is included only in the authentication audit log.

The following table lists the mapping between the result codes returned by the ODBC database stored procedure and Cisco ISE authentication result codes:

Result code (returned by the stored procedure)	Description	Cisco ISE authentication result code
0	CODE_SUCCESS	NA (authentication passed)
1	CODE_UNKNOWN_USER	UnknownUser
2	CODE_INVALID_PASSWORD	Failed
3	CODE_UNKNOWN_USER_OR_INVALID_PASSWORD	UnknownUser
4	CODE_INTERNAL_ERROR	Error
10001	CODE_ACCOUNT_DISABLED	DisabledUser
10002	CODE_PASSWORD_EXPIRED	NotPerformedPasswordExpired



Note Cisco ISE performs the actual authentication or lookup operation based on this mapped authentication result code.

You can use the stored procedures to fetch groups and attributes from the ODBC database.

Here is a sample procedure that returns recordset for plain text password authentication (for Microsoft SQL Server):

```
CREATE PROCEDURE [dbo].[ISEAuthUserPlainReturnsRecordset]
    @username varchar(64), @password varchar(255)
AS
BEGIN
    IF EXISTS( SELECT username
    FROM NetworkUsers
    WHERE username = @username
    AND password = @password )
    SELECT 0,11,'give full access','No Error'
    FROM NetworkUsers
    WHERE username = @username
    ELSE
    SELECT 3,0,'odbc','ODBC Authen Error'
END
```

Here is a sample procedure that returns recordset for plain text password fetching (for Microsoft SQL Server):

```
CREATE PROCEDURE [dbo].[ISEFetchPasswordReturnsRecordset]
    @username varchar(64)
AS
BEGIN
    IF EXISTS( SELECT username
    FROM NetworkUsers
```

```

WHERE username = @username)
SELECT 0,11,'give full access','No Error',password
FROM NetworkUsers
WHERE username = @username
ELSE
SELECT 3,0,'odbc','ODBC Authen Error'
END

```

Here is a sample procedure that returns recordset for Lookup (for Microsoft SQL Server):

```

CREATE PROCEDURE [dbo].[ISEUserLookupReturnsRecordset]
    @username varchar(64)
AS
BEGIN
    IF EXISTS( SELECT username
FROM NetworkUsers
WHERE username = @username)
SELECT 0,11,'give full access','No Error'
FROM NetworkUsers
WHERE username = @username
ELSE
SELECT 3,0,'odbc','ODBC Authen Error'
END

```

Here is a sample procedure that returns parameters for plain text password authentication (for Microsoft SQL Server):

```

CREATE PROCEDURE [dbo].[ISEAuthUserPlainReturnsParameters]
    @username varchar(64), @password varchar(255), @result INT OUTPUT, @group varchar(255)
    OUTPUT, @acctInfo varchar(255) OUTPUT, @errorString varchar(255) OUTPUT
AS
BEGIN
    IF EXISTS( SELECT username
FROM NetworkUsers
WHERE username = @username
AND password = @password )
SELECT @result=0, @group=11, @acctInfo='give full access', @errorString='No Error'
FROM NetworkUsers
WHERE username = @username
ELSE
SELECT @result=3, @group=0, @acctInfo='odbc', @errorString='ODBC Authen Error'
END

```

Here is a sample procedure that returns parameters for plain text password fetching (for Microsoft SQL Server):

```

CREATE PROCEDURE [dbo].[ISEFetchPasswordReturnsParameters]
    @username varchar(64), @result INT OUTPUT, @group varchar(255) OUTPUT, @acctInfo
    varchar(255) OUTPUT, @errorString varchar(255) OUTPUT, @password varchar(255) OUTPUT
AS
BEGIN
    IF EXISTS( SELECT username
FROM NetworkUsers
WHERE username = @username)
SELECT @result=0, @group=11, @acctInfo='give full access', @errorString='No Error',
@password=password
FROM NetworkUsers
WHERE username = @username
ELSE
SELECT @result=3, @group=0, @acctInfo='odbc', @errorString='ODBC Authen Error'
END

```

Here is a sample procedure that returns parameters for Lookup (for Microsoft SQL Server):

```

CREATE PROCEDURE [dbo].[ISEUserLookupReturnsParameters]
    @username varchar(64), @result INT OUTPUT, @group varchar(255) OUTPUT, @acctInfo
    varchar(255) OUTPUT, @errorString varchar(255) OUTPUT

```



```

AS
BEGIN
    IF EXISTS( SELECT username
              FROM NetworkUsers
              WHERE username = @username)
        SELECT @result=0, @group=11, @acctInfo='give full access', @errorString='No Error'
        FROM NetworkUsers
        WHERE username = @username
    ELSE
        SELECT @result=3, @group=0, @acctInfo='odbc', @errorString='ODBC Authen Error'
END

```

Here is a sample procedure that fetches groups from Microsoft SQL Server:

```

CREATE PROCEDURE [dbo].[ISEGroupsH]
    @username varchar(64), @result int output
AS
BEGIN
    if exists (select * from NetworkUsers where username = @username)
    begin
        set @result = 0
        select 'accountants', 'engineers', 'sales','test_group2'
    end
    else
        set @result = 1
END

```

Here is a sample procedure that fetches all the groups of all the users if the username is "*" (for Microsoft SQL Server):

```

ALTER PROCEDURE [dbo].[ISEGroupsH]
    @username varchar(64), @result int output
AS
BEGIN
    if @username = '*'
    begin
        -- if username is equal to '*' then return all existing
        groups
        set @result = 0
        select 'accountants', 'engineers',
        'sales','test_group1','test_group2','test_group3','test_group4'
    end
    else
        if exists (select * from NetworkUsers where username = @username)
        begin
            set @result = 0
            select 'accountants'
        end
        else
            set @result = 1
END

```

Here is a sample procedure that fetches attributes from Microsoft SQL Server:

```

CREATE PROCEDURE [dbo].[ISEAttrsH]
    @username varchar(64), @result int output
AS
BEGIN
    if exists (select * from NetworkUsers where username = @username)
    begin
        set @result = 0
        select phone as phone, username as username, department as
        department, floor as floor, memberOf as memberOf, isManager as isManager from NetworkUsers
        where username = @username
    end
    else
END

```

```

        set @result = 1
    END

```

Additional Examples of ODBC Configuration

<https://www.cisco.com/c/en/us/support/docs/security/identity-services-engine/211581-Configure-ODBC-on-ISE-2-3-with-Oracle-Da.html>

<https://www.cisco.com/c/en/us/support/docs/security/identity-services-engine-21/200544-Configure-ISE-2-1-with-MS-SQL-using-ODBC.html>

<https://www.cisco.com/c/en/us/support/docs/security/identity-services-engine-21/200644-Configure-ODBC-on-ISE-2-1-with-PostgreSQL.html>

Add ODBC Identity Source

Before you begin

To perform the following task, you must be a Super Admin or System Admin.

-
- Step 1** Choose **Administration > Identity Management > External Identity Sources**.
- Step 2** Click **ODBC**.
- Step 3** Click **Add**.
- Step 4** In the **General** tab, enter a name and description for the ODBC identity source.
- Step 5** In the **Connection** tab, enter the following details:
- Hostname or IP address of the ODBC database. If you are using a nonstandard TCP port for the database, you can specify the port number in the following format: hostname or IP address:port
 - Name of the ODBC database
 - Admin username and password (Cisco ISE connects to the database using these credentials)
 - Server timeout in seconds (default is 5 seconds)
 - Connection attempts (default is 1)
 - Database type. Choose one of the following:
 - **MySQL**
 - **Oracle**
 - **PostgreSQL**
 - **Microsoft SQL Server**
 - **Sybase**
- Step 6** Click **Test Connection** to check the connectivity with the ODBC database and to verify the existence of the stored procedures for the configured use cases.
- Step 7** In the **Stored Procedures** tab, enter the following details:
- Step 8** Add the required attributes in the **Attributes** tab. While adding an attribute, you can specify how the attribute name should appear in the authorization policy rules.
- Step 9** Add the user groups in the **Groups** tab. You can also fetch the groups from the ODBC database by specifying the username or MAC address. These groups can be used in authorization policies.

You can rename the groups and attributes. By default, the name that is displayed in the **Name in ISE** field is same as that in ODBC database, however, you can modify this name. This name is used in the authorization policies.

Step 10 Click **Submit**.



Note If you have configured input attributes, you must do the following while duplicating an ODBC identity store. Otherwise, input parameters might be lost in the duplicated ODBC identity store.

1. Click **Advance Settings**.
2. Verify whether the input parameters are set properly.
3. Click **OK** to save these input parameters in the duplicated ODBC identity store.

RADIUS Token Identity Sources

A server that supports the RADIUS protocol and provides authentication, authorization, and accounting (AAA) services to users and devices is called a RADIUS server. A RADIUS identity source is simply an external identity source that contains a collection of subjects and their credentials and uses the RADIUS protocol for communication. For example, the Safeword token server is an identity source that can contain several users and their credentials as one-time passwords that provides an interface that you can query using the RADIUS protocol.

Cisco ISE supports any RADIUS RFC 2865-compliant server as an external identity source. Cisco ISE supports multiple RADIUS token server identities, for example the RSA SecurID server and the SafeWord server. RADIUS identity sources can work with any RADIUS token server that is used to authenticate a user.



Note The Process Host Lookup option must be enabled for MAB authentication. We recommend that you don't configure the RADIUS token server that is used as the external identity source, for MAB authentication, because the devices that are using MAB authentication cannot generate an OTP or a RADIUS token (which is required for RADIUS token server authentication). Hence, the authentication will fail. You can use the external RADIUS server option to process the MAB requests.

RADIUS Token Server-Supported Authentication Protocols

Cisco ISE supports the following authentication protocols for RADIUS identity sources:

- RADIUS PAP
- Protected Extensible Authentication Protocol (PEAP) with inner Extensible Authentication Protocol-Generic Token Card (EAP-GTC)
- EAP-FAST with inner EAP-GTC

Ports Used by the RADIUS Token Servers for Communication

RADIUS token servers use the UDP port for authentication sessions. This port is used for all RADIUS communication. For Cisco ISE to send RADIUS one-time password (OTP) messages to a RADIUS-enabled token server, you must ensure that the gateway devices between Cisco ISE and the RADIUS-enabled token server allow communication over the UDP port. You can configure the UDP port through the Admin portal.

RADIUS Shared Secret

You must provide a shared secret while configuring RADIUS identity sources in Cisco ISE. This shared secret should be the same as the shared secret that is configured on the RADIUS token server.

Failover in RADIUS Token Servers

Cisco ISE allows you to configure multiple RADIUS identity sources. Each RADIUS identity source can have primary and secondary RADIUS servers. When Cisco ISE is unable to connect to the primary server, it uses the secondary server.

Configurable Password Prompt in RADIUS Token Servers

RADIUS identity sources allow you to configure the password prompt. You can configure the password prompt through the Admin portal.

RADIUS Token Server User Authentication

Cisco ISE obtains the user credentials (username and passcode) and passes them to the RADIUS token server. Cisco ISE also relays the results of the RADIUS token server authentication processing to the user.

User Attribute Cache in RADIUS Token Servers

RADIUS token servers, by default, do not support user lookups. However, the user lookup functionality is essential for the following Cisco ISE features:

- PEAP session resume: This feature allows the PEAP session to resume after successful authentication during EAP session establishment.
- EAP/FAST fast reconnect: This feature allows fast reconnection after successful authentication during EAP session establishment.
- TACACS+ Authorization: Happens after a successful TACACS+ authentication.

Cisco ISE caches the results of successful authentications to process user lookup requests for these features. For every successful authentication, the name of the authenticated user and the retrieved attributes are cached. Failed authentications are not written to the cache.

The cache is available in the memory at runtime and is not replicated between Cisco ISE nodes in a distributed deployment. You can configure the Time to Live (TTL) limit for the cache through the Admin portal. You must enable the identity caching option and set the aging time in minutes. The cache is available in the memory for the specified amount of time.

RADIUS Identity Source in Identity Sequence

You can add the RADIUS identity source for authentication sequence in an identity source sequence. However, you cannot add the RADIUS identity source for attribute retrieval sequence because you cannot query the RADIUS identity source without authentication. Cisco ISE cannot distinguish among different errors while authenticating with a RADIUS server. RADIUS servers return an Access-Reject message for all errors. For example, when a user is not found in the RADIUS server, instead of returning a User Unknown status, the RADIUS server returns an Access-Reject message.

RADIUS Server Returns the Same Message for All Errors

When a user is not found in the RADIUS server, the RADIUS server returns an Access-Reject message. Cisco ISE provides an option to configure this message through the Admin portal as either an Authentication Failed or a User Not Found message. However, this option returns a User Not Found message not only for cases where the user is not known, but for all failure cases.

The following table lists the different failure cases that are possible with RADIUS identity servers.

Table 34: Error Handling

Failure Cases	Reasons for Failure
Authentication Failed	<ul style="list-style-type: none"> • User is unknown. • User attempts to log in with an incorrect passcode. • User login hours expired.
Process Failed	<ul style="list-style-type: none"> • RADIUS server is configured incorrectly in Cisco ISE. • RADIUS server is unavailable. • RADIUS packet is detected as malformed. • Problem during sending or receiving a packet from the RADIUS server. • Timeout.
Unknown User	Authentication failed and the Fail on Reject option is set to false.

Safeword Server Supports Special Username Format

The Safeword token server supports authentication with the following username format:

Username—Username, OTP

As soon as Cisco ISE receives the authentication request, it parses the username and converts it to the following username:

Username—Username

The SafeWord token servers support both of these formats. Cisco ISE works with various token servers. While configuring a SafeWord server, you must check the SafeWord Server check box in the Admin portal for Cisco ISE to parse the username and convert it to the specified format. This conversion is done in the RADIUS token server identity source before the request is sent to the RADIUS token server.

Authentication Request and Response in RADIUS Token Servers

When Cisco ISE forwards an authentication request to a RADIUS-enabled token server, the RADIUS authentication request contains the following attributes:

- User-Name (RADIUS attribute 1)
- User-Password (RADIUS attribute 2)
- NAS-IP-Address (RADIUS attribute 4)


Cisco ISE expects to receive any one of the following responses:

- Access-Accept: No attributes are required, however, the response can contain a variety of attributes based on the RADIUS token server configuration.
- Access-Reject: No attributes are required.
- Access-Challenge: The attributes that are required per RADIUS RFC are the following:
 - State (RADIUS attribute 24)
 - Reply-Message (RADIUS attribute 18)
 - One or more of the following attributes: Vendor-Specific, Idle-Timeout (RADIUS attribute 28), Session-Timeout (RADIUS attribute 27), Proxy-State (RADIUS attribute 33)
 No other attributes are allowed in Access-Challenge.

Add a RADIUS Token Server

Before you begin

To perform the following task, you must be a Super Admin or System Admin.

-
- Step 1** ChooseIn the Cisco ISE GUI, click the **Menu** icon () and choose **Administration External Identity Sources > RADIUS Token > Add**.
- Step 2** Enter the values in the **General** and **Connection** tabs.
- Step 3** Click the **Authentication** tab.

This tab allows you to control the responses to an Access-Reject message from the RADIUS token server. This response could either mean that the credentials are invalid or that the user is not known. Cisco ISE accepts one of the following responses: Failed authentication or User not found. This tab also allows you to enable identity caching and to set the aging time for the cache. You can also configure a prompt to request the password.

- a) Click the **Treat Rejects as 'authentication failed'** radio button if you want the Access-Reject response from the RADIUS token server to be treated as a failed authentication.
- b) Click the **Treat Rejects as 'user not found'** radio button if you want the Access-Reject response from the RADIUS token server to be treated as an unknown user failure.

Step 4 Check the **Enable Passcode Caching** check box if you want Cisco ISE to store the passcode in the cache after the first successful authentication with an RADIUS token server and use the cached user credentials for the subsequent authentications if they happen within the configured time period.

Enter the number of seconds for which the passcode must be stored in the cache in the **Aging Time** field. Within this period of time, the user can perform more than one authentication with the same passcode. The default value is 30 seconds. The valid range is from 1 to 300 seconds.

Note Cisco ISE clears the cache after the first failed authentication. The user must enter a new, valid passcode.

Note We strongly recommend that you enable this option only when you use a protocol that supports encryption of the passcode, for example, EAP-FAST-GTC. For information on supported authentication protocols for RADIUS Token server, see [RADIUS Token Server-Supported Authentication Protocols, on page 423](#)

Step 5 Click the **Authorization** tab.

This tab allows you to configure a name that will appear for the attribute that is returned by the RADIUS token server while sending an Access-Accept response to Cisco ISE. This attribute can be used in authorization policy conditions. The default value is CiscoSecure-Group-Id.


Note If you want to send any attribute in Access-Accept from External ID source, Ext ID source needs to send <ciscoavpair> as attribute name and value in the format: ACS:<attrname>=<attrvalue> where <attrname> is configured in the **Authorization** tab.

Step 6 Click **Submit**.

Delete a RADIUS Token Server

Before you begin

- To perform the following task, you must be a Super Admin or System Admin.
- Ensure that you do not select the RADIUS token servers that are part of an identity source sequence. If you select a RADIUS token server that is part of an identity source sequence for deletion, the delete operation fails.

Step 1 Choose In the Cisco ISE GUI, click the **Menu** icon () and choose **Administration** > **Identity Management** > **External Identity Sources** > **RADIUS Token**.

Step 2 Check the check box next to the RADIUS token server or servers that you want to delete, then click **Delete**.

Step 3 Click **OK** to delete the RADIUS token server or servers that you have selected.

If you select multiple RADIUS token servers for deleting, and one of them is used in an identity source sequence, the delete operation fails and none of the RADIUS token servers are deleted.

RSA Identity Sources

Cisco ISE supports the RSA SecurID server as an external database. RSA SecurID two-factor authentication consists of the PIN of the user and an individually registered RSA SecurID token that generates single-use token codes based on a time code algorithm. A different token code is generated at fixed intervals (usually each at 30 or 60 seconds). The RSA SecurID server validates this dynamic authentication code. Each RSA SecurID token is unique, and it is not possible to predict the value of a future token based on past tokens. Thus, when a correct token code is supplied together with a PIN, there is a high degree of certainty that the person is a valid user. Therefore, RSA SecurID servers provide a more reliable authentication mechanism than conventional reusable passwords.

Cisco ISE supports the following RSA identity sources:

- RSA ACE/Server 6.x series
- RSA Authentication Manager 7.x and 8.0 series

You can integrate with RSA SecurID authentication technology in any one of the following ways:

- Using the RSA SecurID agent: Users are authenticated with their username and passcode through the RSA native protocol.
- Using the RADIUS protocol: Users are authenticated with their username and passcode through the RADIUS protocol.

The RSA SecurID token server in Cisco ISE connects with the RSA SecurID authentication technology by using the RSA SecurID Agent.

Cisco ISE supports only one RSA realm.

Cisco ISE and RSA SecurID Server Integration

These are the two administrative roles involved in connecting Cisco ISE with an RSA SecurID server:

- RSA Server Administrator: Configures and maintains RSA systems and integration
- Cisco ISE Administrator: Configures Cisco ISE to connect to the RSA SecurID server and maintains the configuration

This section describes the processes that are involved in connecting Cisco ISE with the RSA SecurID server as an external identity source. For more information on RSA servers, please refer to the RSA documentation.

RSA Configuration in Cisco ISE

The RSA administrative system generates an `sdconf.rec` file, which the RSA system administrator will provide to you. This file allows you to add Cisco ISE servers as RSA SecurID agents in the realm. You have to browse and add this file to Cisco ISE. By the process of replication, the primary Cisco ISE server distributes this file to all the secondary servers.

RSA Agent Authentication Against the RSA SecurID Server

After the `sdconf.rec` file is installed on all Cisco ISE servers, the RSA agent module initializes, and authentication with RSA-generated credentials proceeds on each of the Cisco ISE servers. After the agent on

each of the Cisco ISE servers in a deployment has successfully authenticated, the RSA server and the agent module together download the securid file. This file resides in the Cisco ISE file system and is in a well-known place defined by the RSA agent.

RSA Identity Sources in a Distributed Cisco ISE Environment

Managing RSA identity sources in a distributed Cisco ISE environment involves the following:

- Distributing the `sdconf.rec` and `sdopts.rec` files from the primary server to the secondary servers.
- Deleting the `securid` and `sdstatus.12` files.

RSA Server Updates in a Cisco ISE Deployment

After you have added the `sdconf.rec` file in Cisco ISE, the RSA SecurID administrator might update the `sdconf.rec` file in case of decommissioning an RSA server or adding a new RSA secondary server. The RSA SecurID administrator will provide you with an updated file. You can then reconfigure Cisco ISE with the updated file. The replication process in Cisco ISE distributes the updated file to the secondary Cisco ISE servers in the deployment. Cisco ISE first updates the file in the file system and coordinates with the RSA agent module to phase the restart process appropriately. When the `sdconf.rec` file is updated, the `sdstatus.12` and `securid` files are reset (deleted).

Override Automatic RSA Routing

You can have more than one RSA server in a realm. The `sdopts.rec` file performs the role of a load balancer. Cisco ISE servers and RSA SecurID servers operate through the agent module. The agent module that resides on Cisco ISE maintains a cost-based routing table to make the best use of the RSA servers in the realm. You can, however, choose to override this routing with a manual configuration for each Cisco ISE server for the realm using a text file called `sdopts.rec` through the Admin portal. Refer to the RSA documentation for information on how to create this file.

RSA Node Secret Reset

The `securid` file is a secret node key file. When RSA is initially set up, it uses a secret to validate the agents. When the RSA agent that resides in Cisco ISE successfully authenticates against the RSA server for the first time, it creates a file on the client machine called `securid` and uses it to ensure that the data exchanged between the machines is valid. At times, you may have to delete the `securid` file from a specific Cisco ISE server or a group of servers in your deployment (for example, after a key reset on the RSA server). You can use the Cisco ISE Admin portal to delete this file from a Cisco ISE server for the realm. When the RSA agent in Cisco ISE authenticates successfully the next time, it creates a new `securid` file.



Note If authentications fail after upgrading to a latest release of Cisco ISE, reset the RSA secret.

RSA Automatic Availability Reset

The `sdstatus.12` file provides information about the availability of RSA servers in the realm. For example, it provides information on which servers are active and which are down. The agent module works with the RSA servers in the realm to maintain this availability status. This information is serially listed in the `sdstatus.12` file, which is sourced in a well-known location in the Cisco ISE file system. Sometimes this file becomes old and the current status is not reflected in this file. You must remove this file so that the current status can be

recreated. You can use the Admin portal to delete the file from a specific Cisco ISE server for a specific realm. Cisco ISE coordinates with the RSA agent and ensures correct restart phasing.

The `sdstatus.12` file is deleted whenever the `securid` file is reset, or the `sdconf.rec` or `sdopts.rec` files are updated.


Add RSA Identity Sources

To create an RSA identity source, you must import the RSA configuration file (`sdconf.rec`). You must obtain the `sdconf.rec` file from your RSA administrator. To perform this task, you must be a Super Admin or System Admin.

Adding an RSA identity source involves the following tasks:

Import the RSA Configuration File

You must import the RSA configuration file to add an RSA identity source in Cisco ISE.

-
- Step 1** Choose In the Cisco ISE GUI, click the **Menu** icon () and choose **Administration > Identity Management > External Identity Sources > RSA SecurID > Add**.
- Step 2** Click **Browse** to choose the new or updated `sdconf.rec` file from the system that is running your client browser.
- When you create the RSA identity source for the first time, the Import new `sdconf.rec` file field will be a mandatory field. From then on, you can replace the existing `sdconf.rec` file with an updated one, but replacing the existing file is optional.
- Step 3** Enter the server timeout value in seconds. Cisco ISE will wait for a response from the RSA server for the amount of time specified before it times out. This value can be any integer from 1 to 199. The default value is 30 seconds.
- Step 4** Check the **Reauthenticate on Change PIN** check box to force a reauthentication when the PIN is changed.
- Step 5** Click **Save**.
- Cisco ISE also supports the following scenarios:
- Configuring the Options File for a Cisco ISE Server and Resetting SecurID and `sdstatus.12` Files.
 - Configuring Authentication Control Options for RSA Identity Source.
-

Configure the Options File for a Cisco ISE Server and Resetting SecurID and `sdstatus.12` Files

-
- Step 1** Log into the Cisco ISE server.
- Step 2** Choose **Administration > Identity Management > External Identity Sources > RSA SecurID > Add**.
- Step 3** Click the **RSA Instance Files** tab.
- This page lists the `sdopts.rec` files for all the Cisco ISE servers in your deployment.
- The Node Secret Status is displayed as *Created* when the user is authenticated against RSA SecurID token server. The Node Secret Status can be one of the following—Created or Not Created. The Node Secret Status is displayed as *Not Created* when it is cleared.
- Step 4** Click the radio button next to the `sdopts.rec` file for a particular Cisco ISE server, and click **Update Options File**.
- The existing file is displayed in the Current File region.

- Step 5** Choose one of the following:
- Use the Automatic Load Balancing status maintained by the RSA agent—Choose this option if you want the RSA agent to automatically manage load balancing.
 - Override the Automatic Load Balancing status with the sdopts.rec file selected below—Choose this option if you want to manually configure load balancing based on your specific needs. If you choose this option, you must click **Browse** and choose the new sdopts.rec file from the system that is running your client browser.
- Step 6** Click **OK**.
- Step 7** Click the row that corresponds to the Cisco ISE server to reset the securid and sdstatus.12 files for that server:
- a) Click the drop-down arrow and choose **Remove on Submit** in the Reset securid File and Reset sdstatus.12 File columns.
Note The Reset sdstatus.12 File field is hidden from your view. Using the vertical and horizontal scroll bars in the innermost frame, scroll down and then to your right to view this field.
 - b) Click **Save** in this row to save the changes.
- Step 8** Click **Save**.
-

Configure Authentication Control Options for RSA Identity Source

You can specify how Cisco ISE defines authentication failures and enable identity caching. The RSA identity source does not differentiate between “Authentication failed” and “User not found” errors and sends an Access-Reject response.


You can define how Cisco ISE should handle such failures while processing requests and reporting failures. Identity caching enables Cisco ISE to process requests that fail to authenticate against the Cisco ISE server the second time. The results and the attributes retrieved from the previous authentication are available in the cache.

Configure RSA Prompts

Cisco ISE allows you to configure RSA prompts that are presented to the user while processing requests sent to the RSA SecurID server.

Before you begin

To perform the following task, you must be a Super Admin or System Admin.


-
- Step 1** Choose In the Cisco ISE GUI, click the **Menu** icon () and choose **Administration** > **Identity Management** > **External Identity Sources** > **RSA SecurID**.
- Step 2** Click **Prompts**.
- Step 3** Enter the values as described in RSA SecurID Identity Source Settings.
- Step 4** Click **Submit**.
-

Configure RSA Messages

Cisco ISE allows you to configure messages that are presented to the user while processing requests sent to the RSA SecurID server.

Before you begin

To perform the following task, you must be a Super Admin or System Admin.

-
- Step 1** ChooseIn the Cisco ISE GUI, click the **Menu** icon () and choose **Administration** > **Identity Management** > **External Identity Sources** > **RSA SecurID**.
 - Step 2** Click **Prompts**.
 - Step 3** Click the **Messages** tab.
 - Step 4** Enter the values as described in RSA SecurID Identity Source Settings.
 - Step 5** Click **Submit**.
-

SAMLv2 Identity Provider as an External Identity Source

Security Assertion Markup Language (SAML) is an XML-based open standard data format that enables administrators to access a defined set of applications seamlessly after signing into one of those applications. SAML describes the exchange of security related information between trusted business partners. SAML enables exchange of security authentication information between an Identity Provider (IdP) and a service provider (in this case, ISE).

SAML Single Sign On (SSO) establishes a Circle of Trust (CoT) by exchanging metadata and certificates as part of the provisioning process between the IdP and the Service Provider. The Service Provider trusts the IdP's user information to provide access to the various services or applications.

Enabling SAML SSO results in several advantages:

- It reduces password fatigue by removing the need for entering different user name and password combinations.
- It improves productivity because you spend less time re-entering credentials for the same identity.
- It transfers the authentication from your system that hosts the applications to a third party system.
- It reduces costs as fewer help desk calls are made for password reset, thereby leading to more savings.

The IdP is an authentication module that creates, maintains, and manages identity information for users, systems, or services. The IdP stores and validates the user credentials and generates a SAML response that allows the user to access the service provider protected resources.



Note You must be familiar with your IdP service, and ensure that it is currently installed and operational.

SAML SSO is supported for the following portals:

- Guest portal (sponsored and self-registered)

- Sponsor portal
- My Devices portal
- Certificate Provisioning portal



Note Note that the session services must be enabled on the node on which you want to enable SAML SSO. To enable this option:

1. Choose **Administration > System > Deployment**.
2. Select the node and click **Edit**.
3. In the **General Settings** tab, enable the **Policy Service** toggle button.
4. Check the **Enable Session Services** check box and click .

You cannot select IdP as external identity source for BYOD portal, but you can select an IdP for a guest portal and enable BYOD flow.

Cisco ISE is SAMLv2 compliant and supports all SAMLv2 compliant IdPs that use Base64-encoded certificates. The IdPs listed below have been tested with Cisco ISE:

- Oracle Access Manager (OAM)
- Oracle Identity Federation (OIF)
- SecureAuth
- PingOne
- PingFederate
- Azure Active Directory

The IdP cannot be added to an identity source sequence.

The SSO session will be terminated and Session Timeout error message will be displayed if there is no activity for the specified time (default is 5 minutes).

If you want to add the Sign On Again button in the Error page of the portal, add the following JavaScript in the Optional Content field in the Portal Error page:

```
<button class="cisco-ise" data-inline="true" data-mini="true" data-theme="b"
id="ui_aup_accept_button" onclick="location.href='PortalSetup.action?portal=<Portal ID>'"
type="button">SignOn Again</button>
```

Add an SAML Identity Provider

Before you begin

To perform the following task, you must be a Super Admin or System Admin.

- Step 1** Import the Certificate Authority (CA) certificate in to the Trusted Certificate Store, if the certificate is not self-signed by the IdP. Choose **Administration > System > Certificates > Trusted Certificates > Import** to import the CA certificate.
- Step 2** Choose **Work Centers > Network Access > Ext Id Sources**.
- Step 3** Click **SAML Id Providers**.
- Step 4** Click **Add**.
- Step 5** In the **SAML Identity Provider** page, enter the following details:
- Step 6** Click **Submit**.
- Step 7** Go to the Portal Settings page (Guest, Sponsor, Certificate Provisioning, or My Devices portal) and select the IdP that you want to link to that portal in the **Authentication Method** field.
- To access the Portal Settings page:
- Guest portal—Choose **Work Centers > Guest Access > Portals and Components > Guest Portals > Create, Edit, or Duplicate > Portal Behavior and Flow Settings > Portal Settings** (see the Portal Settings for Credentialed Guest Portals section in see [Portal Settings for Credentialed Guest Portals, on page 927](#)).
 - Sponsor portal—Choose **Work Centers > Guest Access > Portals and Components > Sponsor Portals > Create, Edit, or Duplicate > Portal Behavior and Flow Settings > Portal Settings** (see [Portal Settings for Sponsor Portals, on page 940](#)).
 - My Devices portal—Choose **Work Centers > BYOD > Configure > My Devices Portals > Create, Edit, or Duplicate > Portal Behavior and Flow Settings > Portal Settings** (see [Portal Settings for My Devices Portals, on page 1059](#)).
 - Certificate Provisioning portal—Choose **Administration > Device Portal Management > Certificate Provisioning > Create, Edit, or Duplicate > Portal Behavior and Flow Settings > Portal Settings** (see [Portal Settings for Certificate Provisioning Portal](#)).
- Step 8** Click **Save**.
- Step 9** Choose **Work Centers > Network Access > Ext Id Sources > SAML Id Providers**. Select the IdP that is linked to that portal and click **Edit**.
- Step 10** (Optional) In the **Service Provider Info** tab, add the load balancer details. You can add a load balancer in front of ISE nodes to simplify the configuration on the Identity Provider side and optimize the load on ISE nodes.
- The load balancer can be a software-based or hardware-based appliance. It should be able to forward the requests to the ISE nodes in the deployment (by using the port specified at the Portal Settings page).
- When a load balancer is used, only the load balancer URL is provided in the service provider metadata file. If load balancer is not configured, multiple AssertionConsumerService URLs will be included in the service provider metadata file.
- Note** We recommend that you avoid using the same IP address of the load balancer at the portal FQDN setting.
- Step 11** In the **Service Provider Info** tab, click **Export** to export the service provider metadata file.
- The exported metadata includes the signing certificate of Cisco ISE. The signing certificate is identical to the chosen portal's certificate.
- The exported metadata zip file includes a Readme file that contains the basic instructions for configuring each IdP (such as, Azure Active Directory, PingOne, PingFederate, SecureAuth, and OAM).

- Note** You must re-export the service provider metadata, if a load balancer is not configured or if there are any changes in the portal configuration, such as:
- A new ISE node is registered
 - Hostname or IP address of a node is changed
 - Fully qualified domain name (FQDN) of My Devices, Sponsor, or Certificate Provisioning portal is changed
 - Port or interface settings are changed

If the updated metadata is not re-exported, user authentication may fail at the IdP side.

Step 12 Click **Browse** in the dialog box and save the compressed files locally. Unzip the metadata file folder. When you unzip the folder, you will get a metadata file with the name of the portal. The metadata file includes the Provider ID and Binding URI.

Step 13 Login as Admin user in IdP and import the service provider metadata file. Refer to the Identity Provider user documentation for information on how to import the service provider metadata file.

Step 14 In the **Groups** tab, add the required user groups.

Enter the assertion attribute that specifies the group membership of users in the **Group Membership Attribute** field.

Step 15 Add the user attributes in the **Attributes** tab. While adding an attribute, you can specify how the attribute appears in the assertions returned from the IdP. The name that you specify in the "Name in ISE" field will appear in the policy rules. The following data types are supported for the attributes:

- String
- Integer
- IPv4
- Boolean

Note Adding groups and attributes is not mandatory. These groups and attributes can be used for policy and rule settings. If you are using the sponsor portal, you can add the groups and select these groups while configuring the settings for sponsor groups.

Step 16 Configure the following options in the **Advanced Settings** tab:

- Identity Attribute—Select the attribute that specifies the identity of the user that is being authenticated. You can select the Subject Name attribute or an attribute from the Attribute drop-down list.

Note Cisco ISE does not support SAML IdP responses that contain subject name (NameID) in transient or persistent formats. Cisco ISE cannot retrieve the Username attribute assertion from the SAML IdP response if these methods are used and the authentication will fail.

- Email attribute—Select the attribute that contains the email address of the sponsor. This is required to match the self-service guest requests with the sponsor.
- Select one of the following options for multi-value attributes:
 - Each value in a separate XML element—Click this option if your IdP returns multiple values of the same attribute in separate XML elements.

- Multiple values in a single XML element—Click this option if your IdP returns multiple values in a single XML element. You can specify the delimiter in the text box.
- Logout Settings
 - Sign Logout Requests—Check this check box if you want the logout requests to be signed. This option is not displayed for OAM and OIF.

Note SecureAuth does not support SAML Logout.
 - Logout URL—This option is displayed only for OAM and OIF when a load balancer is not configured. When a user logs out of the Sponsor or My Devices portal, the user is redirected to the Logout URL at the IdP to terminate the SSO session and then redirected back to the login page.
 - Redirect Parameter Name—This option is displayed only for OAM and OIF when a load balancer is not configured. The redirect parameter is used to pass the URL of the login page to which the user must be redirected after logging out. The redirect parameter name may differ based on the IdP, for example, end_url or returnUrl. This field is case sensitive.

If logout does not work as expected, check the Identity Provider documentation for the Logout URL and Redirect Parameter Name.

Step 17 Click **Submit**.

Example

For an example of configuring Ping Federate, see [Configure ISE 2.1 Guest Portal with PingFederate SAML SSO](#)

Delete an Identity Provider

Before you begin

To perform the following task, you must be a Super Admin or System Admin.

Ensure that the IdP that you want to delete is not linked to any portal. If the IdP is linked to any portal, the delete operation fails.

Step 1

Step 2 Check the check box next to the IdP that you want to delete, and then click **Delete**.

Step 3 Click **OK** to delete the IdP that you have selected.

Authentication Failure Log

When authentication against SAML ID Store fails and the IdP redirects the user back to ISE portal (through SAML response), ISE will report a failure reason in the authentication log. For Guest portal (with or without

BYOD flow enabled), you can check the RADIUS Livelog (Operations > RADIUS > Live Log) to know the authentication failure reason. For My Devices portal and Sponsor portal, you can check the My Devices Login/Audit report and Sponsor Login/Audit report (under Operations > Reports > Guest) to know the authentication failure reason.

In case of logout failure, you can check the reports and logs to know the failure reason for My Devices, Sponsor, and Guest portal.

Authentication can fail due to the following reasons:

- SAML Response parse errors
- SAML Response validation errors (for example, Wrong Issuer)
- SAML Assertion validation errors (for example, Wrong Audience)
- SAML Response signature validation errors (for example, Wrong Signature)
- IdP signing certificate errors (for example, Certificate Revoked)



Note Cisco ISE does not support SAML responses with encrypted assertions. If this is configured in the IdP, you will see the following error message in ISE: `FailureReason=24803 Unable to find 'username' attribute assertion.`

If the authentication fails, we recommend that you check the "DetailedInfo" attribute in the authentication log. This attribute provides additional information regarding the cause of failure.

Identity Source Sequences

Identity source sequences define the order in which Cisco ISE looks for user credentials in the different databases.

If you have user information in more than one of the databases that are connected to Cisco ISE, you can define the order in which you want Cisco ISE to look for information in these identity sources. Once a match is found, Cisco ISE does not look any further, but evaluates the credentials, and returns the result to the user. This policy is the first match policy.

Create Identity Source Sequences

Before you begin

Ensure that you have configured your external identity sources in Cisco ISE.

To perform the following task, you must be a Super Admin or System Admin.

For allowing guest users to authenticate through Local WebAuth, you must configure both the Guest portal authentication source and the identity source sequence to contain the same identity stores.

Step 1 Choose **Administration > Identity Management > Identity Source Sequences > Add**.

Step 2 Enter a name for the identity source sequence. You can also enter an optional description.

- Step 3** Check the **Select Certificate Authentication Profile** check box and choose a certificate authentication profile for certificate-based authentication.
- Step 4** Choose the database or databases that you want to include in the identity source sequence in the **Selected List** field.
- Step 5** Rearrange the databases in the **Selected list** field in the order in which you want Cisco ISE to search the databases.
- Step 6** Choose one of the following options in the **Advanced Search List** area:
- **Do not access other stores in the sequence and set the AuthenticationStatus attribute to ProcessError:** Choose this option if you want Cisco ISE to discontinue the search, if the user is not found in the first selected identity source.
 - **Treat as if the user was not found and proceed to the next store in the sequence:** Choose this option if you want Cisco ISE to continue searching the other selected identity sources in sequence, if the user is not found in the first selected identity source.
- While processing a request, Cisco ISE searches these identity sources in sequence. Ensure that you have the identity sources in the Selected list field listed in the order in which you want Cisco ISE to search them.
- Step 7** Click **Submit** to create the identity source sequence that you can then use in policies.
-

Delete Identity Source Sequences

You can delete identity source sequences that you no longer use in policies.

Before you begin

- Ensure that the identity source sequence that you are about to delete is not used in any authentication policy.
 - To perform the following task, you must be a Super Admin or System Admin.
-

- Step 1** Choose **Administration > Identity Management > Identity Source Sequences**.
- Step 2** Check the check box next to the identity source sequence or sequences that you want to delete, then click **Delete**.
- Step 3** Click **OK** to delete the identity source sequence or sequences.
-

Identity Source Details in Reports

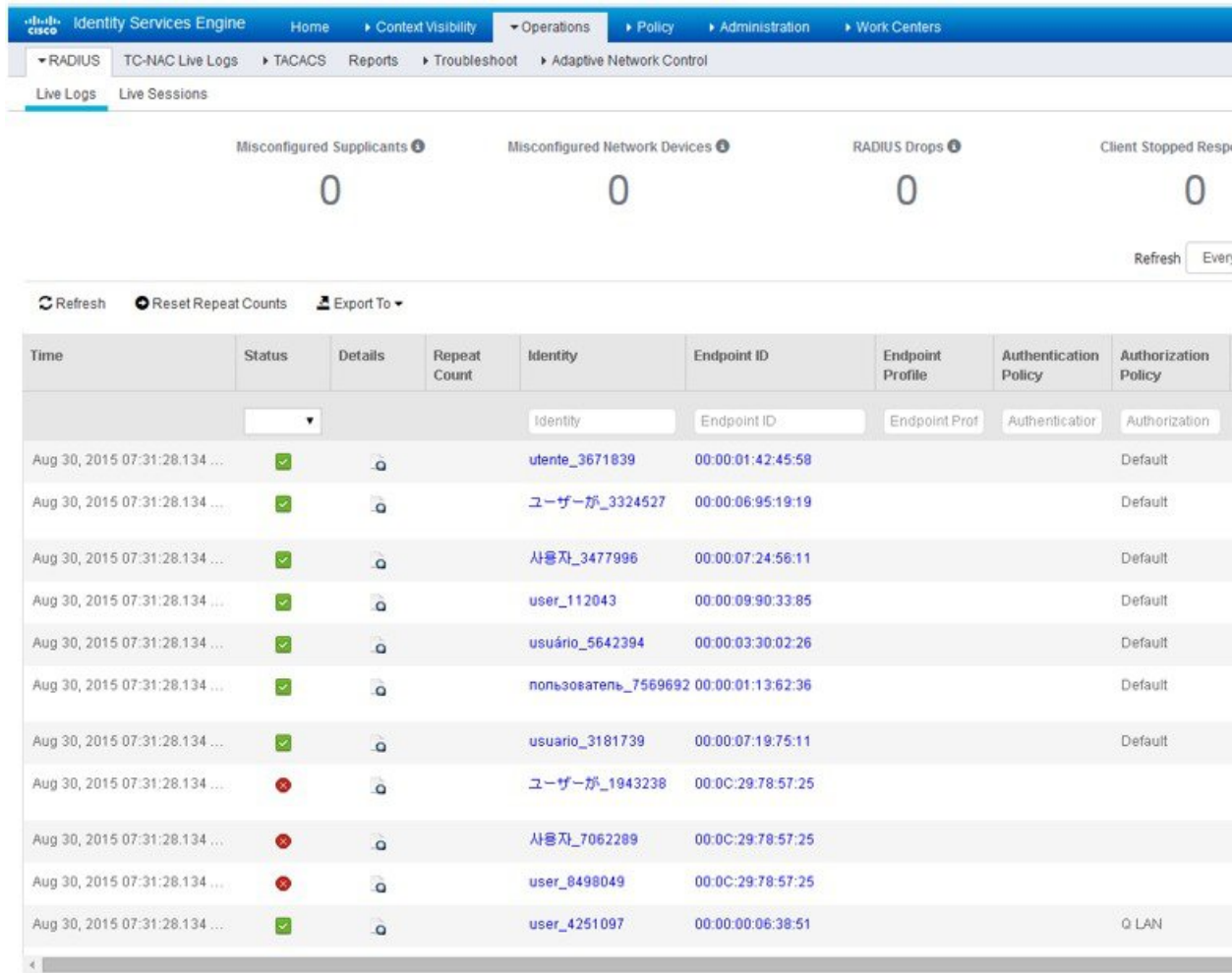
Cisco ISE provides information about the identity sources through the Authentications dashlet and Identity Source reports.

Authentications Dashlet

From the Authentications dashlet, you can drill down to find more information including failure reasons.

Choose Operations > RADIUS Livelog to view real-time authentication summary. For more information about RADIUS Live Logs, see [RADIUS Live Logs, on page 1149](#).

Figure 43: RADIUS Live Logs



Identity Source Reports

Cisco ISE provides various reports that include information about identity sources. See the Available Reports section for a description of these reports.



CHAPTER 16

Configure Guest Access

- [Cisco ISE Guest Services, on page 441](#)
- [Guest and Sponsor Accounts, on page 442](#)
- [Guest Portals, on page 452](#)
- [Sponsor Portals, on page 463](#)
- [Monitor Guest and Sponsor Activity, on page 475](#)
- [Guest Access Web Authentication Options, on page 476](#)

Cisco ISE Guest Services

Cisco Identity Services Engine (Cisco ISE) guest services enable you to provide secure network access to guests such as visitors, contractors, consultants, and customers. You can support guests with basic Cisco ISE licenses, and you can choose from several deployment options depending on your company's infrastructure and feature requirements.

Cisco ISE provides web-based and mobile portals to provide on-boarding for guests and employees to your company's network and internal resources and services.

From the Admin portal, you can create and edit guest and sponsor portals, configure guest access privileges by defining their guest type, and assign sponsor privileges for creating and managing guest accounts.

- [Guest Portals, on page 452](#)
- [Guest Types and User Identity Groups, on page 442](#)
- [Sponsor Portals, on page 463](#)
- [Sponsor Groups, on page 465](#)

ISE Community Resource

For the complete list of ISE community resources for ISE Guest and Web Authentication, see [ISE Guest Access - ISE Guest and Web Authentication](#).

End-User Guest and Sponsor Portals in Distributed Environment

Cisco ISE end-user web portals depend on the Administration, Policy Services, and Monitoring personas to provide configuration, session support, and reporting.

- **Policy Administration node (PAN):** Configuration changes that you make to the users, devices, and end-user portals are written to the PAN.
- **Policy Service node (PSN):** The end-user portals run on a PSN, which handles all session traffic, including: network access, client provisioning, guest services, posture, and profiling. If a PSN is part of a node group, and one node fails, the other nodes detect the failure and reset any pending sessions.
- **Monitoring node (MnT node):** The MnT node collects, aggregates, and reports data about the end-user and device activity on the My Devices, Sponsor, and Guest portals. If the primary MnT node fails, the secondary MnT node automatically becomes the primary MnT node.

Guest and Sponsor Accounts

- **Guest Accounts:** Guests typically represent authorized visitors, contractors, customers, or other users who require temporary access to your network. You can also use guest accounts for employees if you prefer to use one of the guest deployment scenarios to allow employees to access the network. You can access the Sponsor portal to view guest accounts created by a sponsor and by self-registering guests.
- **Sponsor Accounts:** Use the Sponsor portal to create temporary accounts for authorized visitors to securely access your corporate network or the Internet. After creating the guest accounts, you can also use the Sponsor portal to manage these accounts and provide account details to the guests.

Guest accounts can be created by:

- **Sponsors:** On the Admin portal, you can define the access privileges and feature support for sponsors, who can access the Sponsor portal to create and manage guest accounts.
- **Guests:** Guests can also create their own accounts by registering themselves on the Self-Registered Guest portal. Based on the portal configuration, these self-registering guests may need sponsor approval before they receive their login credentials.

Guests can also choose to access the network using the Hotspot Guest portal, which does not require the creation of guest accounts and login credentials, such as username and password.

- **Employees:** Employees who are included in identity stores (such as Active Directory, LDAP, Internal Users) can also gain access through the credentialed Guest portals (Sponsored-Guest and Self-Registered Guest portals), if configured.

After their guest accounts are created, guests can use the Sponsored-Guest portal to log in and gain access to the network.

Guest Types and User Identity Groups

Each guest account must be associated with a guest type. Guest types allow a sponsor to assign different levels of access and different network connection times to a guest account. These guest types are associated with particular network access policies. Cisco ISE includes these default guest types:

- **Contractor:** Users who need access to the network for an extended amount of time, up to a year.
- **Daily:** Guests who need access to the resources on the network for just 1 to 5 days.
- **Weekly:** Users who need access to the network for a couple of weeks.

When creating guest accounts, certain sponsor groups can be restricted to using specific guest types. Members of such a group can create guests with only the features specified for their guest type. For instance, the sponsor group, ALL_ACCOUNTS, can be set up to use only the Contractor guest type, and the sponsor groups, OWN_ACCOUNTS and GROUP_ACCOUNTS, can be set up to use Daily and Weekly guest types. If the self-registering guests using the Self-Registered Guest portal typically need access for just a day, you can assign them the Daily guest type.

The guest type defines the user identity group for a guest.

For more information, see:

- [User Identity Groups, on page 310](#)
- [Create a User Identity Group, on page 315](#)

Create or Edit a Guest Type

Besides creating new guest types, you can edit the default Guest Types' default access privileges and settings. The changes that you make are applied to the existing Guest accounts that were created using this Guest Type. Guest users who are logged in will not see these changes until they log out and log in again. You can also duplicate a Guest Type to create additional Guest Types with the same access privileges.

For an existing guest account, attributes are configured for that account by the Guest Type.

If you make changes to a Guest Type, active Guest accounts will take on all the attributes of the updated Guest Type, including the default access times, dates, and duration, which can then be edited. In addition, the custom fields from the original Guest Type are copied to the updated Guest Type.

Each Guest Type has a name, description, and a list of sponsor groups that can create guest accounts with this guest type. You can designate some guest types as follows: use just for self-registering guests, or do not use to create Guest accounts (by any sponsor group).

Fill in the following fields.

- **Guest type name:** Provide a name (from 1 to 256 characters) that distinguishes this Guest Type from the other Guest Types.
- **Description:** Provide additional information (maximum of 2000 characters) about the recommended use of this Guest Type, for example, Use for self-registering Guests.
- **Language File:** This field allows you to export and import the language file, which contains content for email subject, email message, and SMS messages in all supported languages. These languages and content are used in notifications about an expired account, and are sent to guests who are assigned to this guest type. If you are creating a new guest type, this feature is disabled until after you save the guest type. For more information about editing the language file, see [Portal Language Customization, on page 538](#).
- **Collect Additional Data:** Click the **Custom Fields** option to select which custom fields to use to collect additional data from guests using this Guest Type.

To manage custom fields, choose **Work Centers > Guest Access > Settings > Custom Fields**.

- **Maximum Access Time**

- **Account duration starts:** If you select **From first login**, the account start time starts when the guest user first logs in to the guest portal, and the end time equals the configured duration time. If the guest user never logs in,

the account remains in the `Awaiting first login` state until the guest account purge policy removes the account.

Values are from 1 to 999 days, hours, or minutes.

A self-registered user's account starts when they create and log on to their account.

If you select **From sponsor-specified date**, enter the maximum number of days, hours, or minutes that Guests of this Guest Type can access and stay connected to the network.

If you change these settings, your changes will not apply to existing Guest accounts that were created using this Guest Type.

- **Maximum account duration:** Enter the number of days, hours, or minutes that guests assigned to this guest type can log on.

Note The account purge policy checks for expired guest accounts, and sends expiration notification. This policy runs every 20 minutes, so if you set the account duration to less than 20 mins, it is possible that expiration notices may not be sent out before the account is purged.

You can specify the duration time and the days of the week when access is provided to the guests of this Guest Type by using the **Allow access only on these days and times** option.

- The days of the week that you select limits access to the dates that are selectable in the Sponsor's calendar.
- Maximum account duration is enforced in the sponsor portal, when the Sponsor picks duration and dates.

The settings you make here for access time affect the time settings that are available on the sponsor portal when creating a guest account. For more information, see [Configuring the Time Settings Available to Sponsors](#), on page 473.

• Logon Options

- **Maximum simultaneous logins:** Enter the maximum number of user sessions that users assigned to this Guest Type can have running concurrently.
- **When guest exceeds limit:** When you select **Maximum simultaneous logins**, you must also select the action to take when a user connects after the maximum number of login is reached.
 - **Disconnect the oldest connection**
 - **Disconnect the newest connection:** If you select **Redirect user to a portal page showing an error message**, an error message is displayed for a configurable amount of time, then the session is disconnected, and the user is redirected to the Guest portal. The error page's content is configured on the Portal Page Customization dialog, on the **Messages > Error Messages** window.
- **Maximum devices guests can register:** Enter the maximum number of devices that can be registered to each Guest. You can set the limit to a number lower than what is already registered for the Guests of this Guest Type. This only affects newly created Guest accounts. When a new device is added, and the maximum is reached, the oldest device is disconnected.
- **Endpoint identity group for guest device registration:** Choose an endpoint identity group to assign to guest devices. Cisco ISE provides the **GuestEndpoints** endpoint identity group to use as a default. You can also create more endpoint identity groups if you choose to not use the default.
- **Allow guest to bypass the Guest portal:** Allows users to bypass the credentialed guest-type captive portal (web authentication page), and access the network by providing credentials to wired and wireless (dot1x)

supplicants or VPN clients. Guest accounts change to the `Active` state, bypassing the `Awaiting Initial Login` state and the AUP page, even if the AUP is required.

If you do not enable this setting, users must first log in through the credentialed Guest captive portal before they are able to access other parts of the network.

- **Account Expiration Notification**

- **Send account expiration notification ___ days before account expires:** Send a notification to Guests before their account expires and specify how many days, hours, or minutes before the expiration.
- **View messages in:** Specify the language to use when displaying email or SMS notifications as you set them up.
- **Email:** Send account expiration notices by email.
- **Use customization from:** Apply the same customizations that you configured for the selected portal to this Guest Type's account expiration emails.
- **Copy text from:** Reuse email text that you created for another Guest Type's account expiration email.
- **SMS:** Send account expiration notices by SMS.

The settings that follow for SMS are the same as for email notifications, except that you choose an SMS gateway for **Send test SMS to me**.

- **Sponsor Groups:** Specify the sponsor groups whose members can create a guest account using this guest type. Delete the sponsor groups that you do not want to have access to this guest type.

What to do next

- Create or modify sponsor groups to use this guest type. For more information, see [Sponsor Groups, on page 465](#).
- If appropriate, assign this guest type to self-registering guests in the Self-Registered Guest portal. For more information, see [Create a Self-Registered Guest Portal, on page 460](#).

Disable a Guest Type

You cannot delete the last remaining guest type or guest types that are being used by guest accounts. If you want to delete a guest type that is in use, first ensure that it is no longer available for use. Disabling a guest type does not affect guest accounts that were created with that guest type.

The following steps explain how to prepare for and disable a target guest type.

-
- Step 1** Identify the sponsor groups that allow the sponsor to create guests using the target guest type. Choose **Work Centers > Guest Access > Portals and Components > Sponsor Groups**, and open each sponsor group and examine the **This sponsor group can create accounts using these guest types** list.
 - Step 2** Identify the Self-Registered portals that assign the target guest type. Choose **Work Centers > Guest Access > Portals and Components > Guest Portals**. Open each Self-Registered Guest portal. If the portal is using the specific guest type,

expand **Portal Settings**, and change the assigned guest type in the **Employees using this portal as guests inherit login options from:** field.

- Step 3** Open the guest type you wish to delete, and delete all sponsor groups that you identified in the previous steps. This action effectively prevents all sponsors from using creating a new guest account with this guest type. Choose **Work Centers > Guest Access > Portals and Components > Guest Type**.

Configure Maximum Simultaneous Logins for Endpoint Users

You can configure the maximum number of simultaneous logins that are allowed for a guest.

When the user logs in to a guest portal, and is successfully authenticated, that user's number of existing logins is checked to see if the user has already reached the maximum number of logins. If yes, the Guest user is redirected to an error page. An error page is displayed, and the session is stopped. If that user tries to access the internet again, the user's connection is redirected to the guest portal's login page.

Before you begin

Make sure that the authorization profile that you are using in the authorization policy for this portal has **Access Type** set to *Access_Accept*. If **Access Type** is set to *Access_Reject*, then maximum simultaneous logins is not enforced.

- Step 1**
- Check the **Maximum simultaneous logins** check box and enter the maximum number of simultaneous logins allowed.
 - Under **When guest exceeds limit**, click the **Disconnect the newest connection** option.
 - Check the **Redirect user to a portal page showing an error message** check box.
- Step 2**
- Under **Common Tasks**, check **Web Redirection** and do the following:
 - In the first drop-down, choose **Centralized Web Auth**.
 - Enter the **ACL** you created as part of the prerequisite.
 - For **Value**, select the guest portal to be redirected to.
 - Scroll down in **Common Tasks**, and check the **Reauthentication** check box and do the following:
 - In **Timer**, enter the amount of time you want the error page to display before redirecting the user to the guest portal.
 - In **Maintain Connectivity During Reauthentication**, choose **Default**.
- Step 3** Choose **Policy > Authorization**, and create an authorization policy so that when the attribute `NetworkAccess.SessionLimitExceeded` is true, the user is redirected to the portal.

What to do next

You can customize the text of the error page on the Portal Page Customization tab. Choose **Messages > Error Messages** and change the text of the error message key `ui_max_login_sessions_exceeded_error`.

Schedule When to Purge Expired Guest Accounts

When an active or suspended guest account reaches the end of its account duration (as defined by the sponsor when creating the account), the account expires. When guest accounts expire, the affected guests cannot access the network. Sponsors can extend expired accounts before they are purged. However, after an account is purged, sponsors must create new accounts.

When expired guest accounts are purged, the associated endpoints and reporting and logging information are retained.

Cisco ISE automatically purges expired guest accounts every 15 days, by default. The **Date of next purge** indicates when the next purge will occur. You can also:

- Schedule a purge to occur every X days. The first purge will occur in X days at **Time of Purge**, then purges occur every X days.
- Schedule a purge on a given day of the week every X weeks. The first purge occurs on the next **Day of Week at Time of Purge**, then purges occur every configured number of weeks on that day and time. For example, on Monday you set purges to occur on Thursday every 5 weeks. The next purge will be the Thursday of this week, not the Thursday 5 weeks from now.
- Force a purge to happen immediately by clicking **Purge Now**.

If the Cisco ISE server is down when the purge is scheduled to run, the purge is not executed. The purge process will run again at the next scheduled purge time, assuming the server is operational at that time.

Step 1 Choose **Work Centers > Guest Access > Settings > Guest Account Purge Policy**.

Step 2

Step 3 Choose one of these options:

- Click **Purge Now** to immediately purge the expired guest account records.
- Check **Schedule purge of expired guest accounts** to schedule a purge.

Note After each purge is completed, the **Date of next purge** is reset to the next scheduled purge.

Step 4 Specify after how many **days of inactivity** to purge user-specific portal records maintained in the Cisco ISE database for LDAP and Active Directory users.

Step 5 Click **Save**. If you do not want to save any updates you made to the settings, click **Reset** to revert to the last saved values.

Add Custom Fields for Guest Account Creation

When providing guest access, you may want to collect information from your guests beyond just their names, email addresses, and phone numbers. Cisco ISE provides custom fields that you can use to collect additional information about guests that is specific to your company's needs. You can associate the custom fields with guest types and with the Self-Registered Guest and Sponsor portals. Cisco ISE does not provide any default custom fields.

What to do next

You can include the desired custom fields:

- When defining a guest type so that accounts created with that guest type will include this information. See [Create or Edit a Guest Type, on page 443](#).
- When configuring the Sponsor portal for sponsors to use when creating guest accounts. See [Customize Sponsor Portals, on page 472](#).
- When requesting information from self-registering guests using a Self-Registered Guest portal. See [Create a Self-Registered Guest Portal, on page 460](#).

Specify Email Addresses and SMTP Servers for Email Notifications

Cisco ISE allows you to send emails to sponsors and guests, notifying them of information and instructions. You can configure SMTP servers to deliver these email notifications. You can also specify the email address from which the notifications will be sent to guests.



Note Guest notifications require an UTF-8 compatible e-mail client.

HTML-capable e-mail client (with functionality enabled) is needed to use the single click sponsor approval feature.

Assign Guest Locations and SSIDs

A Guest Location defines a name for a time zone, and is used by ISE to enforce time-related settings of logged on Guests. Guest Locations are assigned to Guest accounts by Sponsors creating a Guest account, and by self-registering Guests. The default Guest Location is San Jose. If no other Guest Locations are added, all accounts are assigned this Guest Location. You can't delete the San Jose Guest Location unless you create one or more new Locations. Unless all your Guests will be in the same time-zone as San Jose, create at least one Guest Location with the required time-zone.



Note Guest access times are based on the Guest Location's time zone. A Guest user may not be able to login if the Guest Location's time zone doesn't match the system time zone. In this case, the Guest user may get an "Authentication Failed" error. You might see the "Guest active time period not yet started" error message in the debug report. As a workaround, you can adjust the Guest access start time to match the local time zone of the Guest user by using the Manage Accounts option.

The SSIDs you add here are available to Sponsor Portals, so Sponsors can tell the Guest which SSID to connect to.

You can't delete a Guest Location or a SSID if it is configured in a Sponsor portal or assigned to a Guest account.

Step 1 To add, edit or delete Guest Locations and SSIDs for Guest and Sponsor portals, choose **Work Centers > Portals & Components > Settings > Guest Locations and SSIDs**.

Step 2

Step 3 For **Guest Locations**:

- For each time-zone that you need to support, enter a **Location name** and pick a **Time zone** from the drop-down list.

b) Click **Add**.

Note In a Guest Location, the name of the place, the name of the time zone, and the GMT offset are static; you cannot change them. The GMT offset does not change with daylight savings time changes. The GMT offsets are the opposite of what is shown in the list. For example, *Etc/GMT+3* is actually GMT-3.

Note For From First-login guest type, ensure that you configure a Guest Location (time zone) only if you intend to configure the access time restrictions in the **Work Centers > Guest Access > Portals & Components > Guest Types** page.

Step 4 For **Guest SSIDs**:

- a) Enter the **SSID** names of the networks that will be available for guests to use at the Guest Locations.
- b) Click **Add**.

Step 5 Click **Save**. To revert to the last saved values, click **Reset**.

What to do next

If you added a new Guest Location or SSID, you can:

- Provide the SSIDs for Sponsors to use when creating Guest accounts. See [Portal Settings for Sponsor Portals, on page 940](#).
- Add the Guest Locations to Sponsor Groups, so that Sponsors assigned to that group can use them when creating guest accounts. See [Configure Sponsor Groups, on page 466](#).
- Assign the Guest Locations available to self-registering guests using a Self-Registered Guest portal. See [Create a Self-Registered Guest Portal, on page 460](#).
- For existing guest accounts, edit them manually to add SSIDs or Locations.

Rules for Guest Password Policies

Cisco ISE has the following built-in rules for guest passwords:

- The Guest password policy applies to sponsor portals, self registered portals, accounts uploaded in a CSV file, passwords created using the ERS API, and user created passwords.
- Changes to the guest password policy do not affect existing accounts, until the guests passwords have expired and need to be changed.
- Passwords are case sensitive.
- The special characters <, >, /, and % cannot be used.
- Minimum length and minimum required characters apply to all passwords.
- Passwords cannot match usernames.
- New passwords cannot match current passwords.
- Guests do not receive notifications before password expiration, unlike guest account expiration. When guest passwords expire, either sponsors can reset the password to a random password or guests can log in using their current login credentials and then change their password.



Note The guest default username is four alphabetic and password is four numeric characters. Short, easy to remember usernames and passwords are adequate for short-term guests. You can change the username and password length in ISE, if you desire.

Set the Guest Password Policy and Expiration

You can define a password policy for all Guest portals. A Guest password policy determines how the password is generated for all guest accounts. A password can be a mixture of alphabetic, numeric, or special characters. You can also set the number of days after which guest passwords will expire, requiring guests to reset their passwords.

The Guest password policy applies to sponsor portals, self registered portals, accounts uploaded in a CSV file, passwords created using the ERS API, and user created passwords.

What to do next

You should customize the error messages that are related to the password policy to provide the password requirements.

1. Choose **Guest Access > Portals & Components > Sponsored-Guest Portals or Self-Registered Guest Portals > Edit > Portal Page Customization > Error Messages**.
2. Search for the keyword policy.

Rules for Guest Username Policies

Cisco ISE has the following built-in rules for guest username policies:

- Changes to the guest username policy do not affect existing accounts, until the guest accounts have expired and need to be changed.
- The special characters <, >, /, and % cannot be used.
- Minimum length and minimum required characters apply to all system-generated usernames, including usernames based on email addresses.
- Passwords cannot match usernames.

Set the Guest Username Policy

You can configure rules for how guest usernames are created. A generated username can be created based on the email address, or based on the first name and last name of the guest. The Sponsor can also create a random number of guest accounts to save time when creating multiple guests, or when guest names and email addresses are not available. Randomly generated guest usernames consist of a mixture of alphabetic, numeric, and special characters. These settings affect all guests.

What to do next

You should customize the error messages that are related to the username policy to provide the username requirements.

1. Choose **Work Centers > Guest Access > Portals & Components > Sponsored-Guest Portals, Self-Registered Guest Portals, Sponsor Portals, or My Devices Portals > Edit > Portal Page Customization > Error Messages**.
2. Search for the keyword `policy`.

SMS Providers and Services

SMS services send SMS notifications to guests that are using credentialed Guest portals. If you plan to send SMS messages, enable this service. Whenever possible, configure and provide free SMS service providers to lower your company's expenses.

Cisco ISE supports a variety of cellular service providers that provide free SMS services to their own subscribers. You can use these providers without a service contract and without configuring their account credentials in Cisco ISE. These include ATT, Orange, Sprint, T-Mobile, and Verizon.

You can also add other cellular service providers that offer free SMS services or a global SMS service provider, such as a Click-A-Tell. The default global SMS service provider requires a service contract and you must configure their account credentials in Cisco ISE.

- If self-registering guests pick their free SMS service provider on the Self-Registration form, SMS notifications with their login credentials are sent to them free of cost. If they do not pick an SMS service provider, then the default global SMS service provider that is contracted by your company sends the SMS notifications.
- To allow sponsors to send SMS notifications to guests whose accounts they created, customize the sponsor portal and select all the appropriate SMS service providers that are available. If you do not select any SMS service providers for the Sponsor portal, the default global SMS service provider that is contracted by your company provides the SMS services.

SMS providers are configured as SMS Gateways in Cisco ISE. Email from Cisco ISE is converted to SMS by the SMS gateway. The SMS gateway can be behind a proxy server.

Configure SMS Gateways to Send SMS Notifications to Guests

You must set up SMS gateways in Cisco ISE to enable:

- Sponsors to manually send SMS notifications to guests with their login credentials and password reset instructions.
- Guests to automatically receive SMS notifications with their login credentials after they successfully register themselves.
- Guests to automatically receive SMS notifications with actions to take before their guest accounts expire.

When entering information in the fields, you should update all text within [], such as [USERNAME], [PASSWORD], [PROVIDER_ID], and so on, with information specific to your SMS provider's account.

Before you begin

Configure a default SMTP server to use for the SMS Email Gateway option.

What to do next

If you configured a new SMS gateway, you can:

- Select the SMS service provider to use when sending SMS notifications about expiring accounts to guests. See [Create or Edit a Guest Type, on page 443](#).
- Specify which of the configured SMS providers should display on the Self-Registration form for self-registering guests to pick from. See [Create a Self-Registered Guest Portal, on page 460](#).

Guest Portals

When people visiting your company wish to use your company's network to access the internet, or resources and services on your network, you can provide them network access through a Guest portal. Employees can use these Guest portals to access your company's network, if configured.

There are three default Guest portals:

- Hotspot Guest portal: Network access is granted without requiring any credentials. Usually, an Acceptance of User Policy (AUP) must be accepted before network access is granted.
- Sponsored-Guest portal: Network access is granted by a sponsor who creates accounts for guests, and provides the guest with login credentials.
- Self-Registered Guest portal: Guests can create their own account credentials, and may need sponsor approval before they are granted network access.

Cisco ISE can host multiple Guest portals, including a predefined set of default portals.

The default portal themes have standard Cisco branding that you can customize through the Admin portal.

Wireless Setup has its own default theme (CSS) and you are able to modify some basic settings such as logo, banner, background image, coloring and fonts. In Cisco ISE, you can also choose to further customize your portal by changing more settings and going into advanced customizations.

Credentials for Guest Portals

Cisco ISE provides secured network access by requiring guests to log in using various types of credentials. You can require that guests log in using one or a combination of these credentials.

- Username: Required. Applies to all guests using end-user portals (except Hotspot Guest portals) and is derived from the username policy. The username policy applies only to system-generated usernames and not to usernames specified using the Guest API programming interface or the self-registering process. You can configure the policy settings that apply to usernames at **Work Centers > Guest Access > Settings > Guest Username Policy**. Guests can be notified of their username in an email, SMS, or in printed form.
- Password: Required. Applies to all guests using end-user portals (except Hotspot Guest portals) and is derived from the password policy. You can configure the policy settings that apply to passwords at **Work**

Centers > Guest Access > Settings > Guest Password Policy. Guests can be notified of their password in an email, SMS, or in printed form.

- **Access code:** Optional. Applies to guests using the Hotspot Guest and Credentialed Guest portals. An access code is primarily a locally known code that is given to physically present guests (either visually via a whiteboard or verbally by a lobby ambassador). It would not be known and used by someone outside the premises to gain access to the network. If the Access code setting is enabled:
 - Sponsored guests are prompted to enter it on the Login page (along with a username and password).
 - Guests using the Hotspot Guest portal are prompted to enter it on the Acceptable Use Policy (AUP) page.
- **Registration code:** Optional. Applies to self-registering guests and is similar to an access code in how it is provided to the self-registering guests. If the Registration code setting is enabled, self-registering guests are prompted to enter it on the Self-Registration form.

The username and password can be provided by a sponsor at your company (for sponsored guests), or a Credentialed Guest portal can be configured to allow guests to register themselves to obtain these credentials.

Related Topics

[Guest Types and User Identity Groups](#), on page 442

Guest Access with Hotspot Guest Portals

Cisco ISE provides network access functionality that includes “hotspots,” which are access points that guests can use to access the Internet without requiring credentials to log in. When guests connect to the hotspot network with a computer or any device with a web browser and attempt to connect to a website, they are automatically redirected to a Hotspot Guest portal. Both wired and wireless (Wi-Fi) connections are supported with this functionality.

The Hotspot Guest portal is an alternative Guest portal that allows you to provide network access without requiring guests to have usernames and passwords and alleviates the need to manage guest accounts. Instead, Cisco ISE works together with the network access device (NAD) and Device Registration Web Authentication (Device Registration WebAuth) to grant network access directly to the guest devices. Sometimes, guests may be required to log in with an access code. Typically, this is a code that is locally provided to guests who are physically present on a company’s premises.

If you support the Hotspot Guest portal:

- Based on the Hotspot Guest portal configuration and settings, guests are granted access to the network if the guest access conditions are met.
- Cisco ISE provides you with a default guest identity group, GuestEndpoints, which enables you to cohesively track guest devices.

Guest Access with Credentialed Guest Portals

You can use a credentialed Guest portal to identify and authorize temporary access for external users to internal networks and services, as well as to the Internet. Sponsors can create temporary usernames and passwords for authorized visitors who can access the network by entering these credentials in the portal's Login page.

You can set up a credentialed Guest portal so that guests can log in using a username and password that is obtained:

- From a sponsor. In this guest flow, guests are greeted by a sponsor, such as a lobby ambassador, when they enter company premises and are set up with individual guest accounts.
- After they register themselves, using an optional registration code or access code. In this guest flow, guests are able to access the Internet without any human interaction and Cisco ISE ensures that these guests have unique identifiers that can be used for compliance.
- After they register themselves, using an optional registration code or access code, but only after the request for a guest account is approved by a sponsor. In this guest flow, guests are provided access to the network, but only after an additional level of screening is done.

You can also force the user to enter a new password when logging in.

Cisco ISE enables you to create multiple credentialed Guest portals, which you can use to allow guest access based on different criteria. For example, you might have a portal for monthly contractors that is separate from the portal used for daily visitors.

Employee Access with Credentialed Guest Portals

Employees can also access the network using Credentialed Guest Portals by signing in using their employee credentials, as long as their credentials can be accessed by the identity source sequence configured for that portal.

Guest Device Compliance

When guests and non-guests access the network through credentialed Guest portals, you can check their devices for compliance before they are allowed to gain access. You can route them to a Client Provisioning window and require them to first download the posture agent that checks their posture profile and verifies if their device is compliant. You can do this by enabling the option in the **Guest Device Compliance Settings** in a credentialed Guest portal, which displays the Client Provisioning window as part of the guest flow.



Note Client posture assessment in guest flow supports only the Temporal agent.

The Client Provisioning service provides posture assessments and remediations for guests. The Client Provisioning portal is available only with a Central Web Authorization (CWA) guest deployment. The guest login flow performs a CWA, and the credentialed Guest portal is redirected to the Client Provisioning portal after performing acceptable-use-policy and change-password checks. The posture subsystem performs a Change of Authorization (CoA) on the network access device to reauthenticate the client connection once the posture has been assessed.

Guest Portals Configuration Tasks

You can use a default portal and its default settings such as certificates, endpoint identity group, identity source sequence, portal themes, images, and other details provided by Cisco ISE. If you do not want to use the default settings, you should create a new portal or edit an existing one to meet your needs. You can duplicate a portal if you want to create multiple portals with the same settings.

After creating a new portal or editing a default one, you must authorize the portal for use. Once you authorize a portal for use, any subsequent configuration changes you make are effective immediately.

If you choose to delete a portal, you must first delete any authorization policy rules and authorization profiles associated with it or modify them to use another portal.

Use this table for the tasks related to configuring the different Guest portals.

Task	Hotspot Guest Portal	Sponsored-Guest Portal	Self-Registered Guest Portal
Enable Policy Services, on page 455	Required	Required	Required
Add Certificates for Guest Portals, on page 456	Required	Required	Required
Create External Identity Sources, on page 456	Not applicable	Required	Required
Create Identity Source Sequences, on page 457	Not applicable	Required	Required
Create Endpoint Identity Groups, on page 687	Required	Not required (defined by guest type)	Not required (defined by guest type)
Create a Hotspot Guest Portal, on page 458	Required	Not applicable	Not applicable
Create a Sponsored-Guest Portal, on page 459	Not applicable	Required	Not applicable
Create a Self-Registered Guest Portal, on page 460	Not applicable	Not applicable	Required
Authorize Portals, on page 461	Required	Required	Required
Customize Guest Portals, on page 463	Optional	Optional	Optional

Enable Policy Services

To support the Cisco ISE end-user web portals, you must enable the portal-policy services on the node on which you want to host them.

-
- Step 1** Choose **Administration** > **System** > **Deployment**.
 - Step 2** Click the node and click **Edit**.
 - Step 3** Under the **General Settings** tab, check the **Policy Service** check box.
 - Step 4** Check the **Enable Session Services** check box.
 - Step 5** Click **Save**.
-

Add Certificates for Guest Portals

If you do not want to use the default certificates, you can add a valid certificate and assign it to a certificate group tag. The default certificate group tag used for all end-user web portals is Default Portal Certificate Group.

Create External Identity Sources

Cisco ISE can connect with external identity sources such as Active Directory, LDAP, RADIUS Token, and RSA SecurID servers to obtain user information for authentication and authorization. External identity sources also include certificate authentication profiles that you need for certificate-based authentications.



Note To work with passive identity services, which enable you to receive and share authenticated user identities, see [Additional Passive Identity Service Providers, on page 369](#).

Step 1 Choose **Administration > Identity Management > External Identity Sources**.

Step 2 Choose one of these options:

- **Certificate Authentication Profile** for certificate-based authentications.
- **Active Directory** to connect to an Active Directory as an external identity source. See [Active Directory as an External Identity Source, on page 323](#) for more details.
- **LDAP** to add an LDAP identity source. See [LDAP, on page 409](#) for more details.
- **RADIUS Token** to add a RADIUS Token server. See [RADIUS Token Identity Sources, on page 423](#) for more details.
- **RSA SecurID** to add an RSA SecurID server. See [RSA Identity Sources, on page 428](#) for more details.
- **SAML Id Providers** to add an identity provider (IdP), such as Oracle Access Manager. See [SAMLv2 Identity Provider as an External Identity Source, on page 432](#) for more details.

Configure Guest Portals to Redirect to SAML IDP Portals for Authentication

You can configure a Guest portal to allow users to be redirected to a SAML IDP portal for authentication.

Configuring the **Allow the following identity-provider guest portal to be used for login** option in a guest portal (self-registered or Sponsored Guest) enables a new login area in that portal. If a user selects that login option, they are redirected to the alternate identity portal (which they don't see), and then to the SAML IDP logon portal for authentication.

For example, the Guest portal could have a link for employee login. Instead of logging in on the existing portal, the user clicks the employee logon link, and is redirected to the SAML IDP single-signon portal. The employee is either reconnected using the token from the last logon with this SAML IDP, or logs in on that SAML site. That allows the same portal to handle both guests and employees from a single SSID.

The following steps show how to configure a Guest portal that calls another portal which is configured to use a SAML IDP for authentication.

Step 1 Configure an external identity source. See [SAMLv2 Identity Provider as an External Identity Source, on page 432](#) for more details.

- Step 2** Create a guest portal for the SAML provider. Set the **Authentication method** in Portal Settings to the SAML provider. The user will not see this portal, it is just a placeholder to direct the user to the SAML IDP logon page. Other portals can be configured to redirect to this sub-portal, as described next.
- Step 3** Create a guest portal with the option to redirect to the guest portal for the SAML provider portal that you just created. This is the main portal, which will redirect to the sub-portal.
- You may want to customize the look of this portal to make it look like the SAML provider.
- On the Login Page Settings page of the main portal, **check Allow the following identity-provider guest portal to be used for login.**
 - Select the guest portal that you configured to use with the SAML provider.
-

Create Identity Source Sequences

Before you begin

Ensure that you have configured your external identity sources in Cisco ISE.

To perform the following task, you must be a Super Admin or System Admin.

For allowing guest users to authenticate through Local WebAuth, you must configure both the Guest portal authentication source and the identity source sequence to contain the same identity stores.

- Step 1** Choose **Administration > Identity Management > Identity Source Sequences > Add.**
- Step 2** Enter a name for the identity source sequence. You can also enter an optional description.
- Step 3** Check the **Select Certificate Authentication Profile** check box and choose a certificate authentication profile for certificate-based authentication.
- Step 4** Choose the database or databases that you want to include in the identity source sequence in the **Selected List** field.
- Step 5** Rearrange the databases in the **Selected list** field in the order in which you want Cisco ISE to search the databases.
- Step 6** Choose one of the following options in the **Advanced Search List** area:
- Do not access other stores in the sequence and set the AuthenticationStatus attribute to ProcessError:** Choose this option if you want Cisco ISE to discontinue the search, if the user is not found in the first selected identity source.
 - Treat as if the user was not found and proceed to the next store in the sequence:** Choose this option if you want Cisco ISE to continue searching the other selected identity sources in sequence, if the user is not found in the first selected identity source.
- While processing a request, Cisco ISE searches these identity sources in sequence. Ensure that you have the identity sources in the Selected list field listed in the order in which you want Cisco ISE to search them.
- Step 7** Click **Submit** to create the identity source sequence that you can then use in policies.
-

Create Endpoint Identity Groups

Cisco ISE groups endpoints that it discovers in to the corresponding endpoint identity groups. Cisco ISE comes with several system-defined endpoint identity groups. You can also create additional endpoint identity groups from the **Endpoint Identity Groups** window. You can edit or delete the endpoint identity groups that

you have created. You can only edit the description of the system-defined endpoint identity groups. You cannot edit the name of these groups or delete them.

-
- Step 1** Choose **Administration > Identity Management > Groups > Endpoint Identity Groups**.
- Step 2** Click **Add**.
- Step 3** Enter the **Name** for the endpoint identity group that you want to create (do not include spaces in the name of the endpoint identity group).
- Step 4** Enter the **Description** for the endpoint identity group that you want to create.
- Step 5** Click the **Parent Group** drop-down list to choose an endpoint identity group to which you want to associate the newly created endpoint identity group.
- Step 6** Click **Submit**.
-

Create a Hotspot Guest Portal

You can provide a Hotspot Guest portal to enable guests to connect to your network without requiring a username and password to log in. An access code can be required to log in.

You can create a new Hotspot Guest portal, or you can edit or duplicate an existing one. You can delete any Hotspot Guest portal, including the default portal provided by Cisco ISE.

Any changes that you make to the Page Settings on the **Portal Behavior and Flow Settings** tab are reflected in the graphical flow in the Guest Flow diagram. If you enable a page, such as the AUP page, it appears in the flow and the guest will experience it in the portal. If you disable it, it is removed from the flow and the next enabled page displays for the guest.

All the Page Settings, except the Authentication Success Settings, are optional.

Before you begin

- Ensure that you have the required certificates and endpoint identity groups configured for use with this portal.
- Ensure that the WLC that guests connect to for the Hotspot portal is supported by Cisco ISE. See the [Identity Services Engine Network Component Compatibility](#) guide for your version of Cisco ISE.

-
- Step 1** Choose **Work Centers > Guest Access > Portals & Components > Guest Portals > Create, Edit or Duplicate**.
- Step 2** If creating a new portal, in the **Create Guest Portal** dialog box, select **Hotspot Guest Portal** as the portal type and click **Continue**.
- Step 3** Provide a unique **Portal Name** and a **Description** for the portal.
Ensure that the portal name that you use here is not used for any other end-user portals.
- Step 4** Use the **Language File** drop-down menu to export and import language files to use with the portal.
- Step 5** Update the default values for ports, Ethernet interfaces, certificate group tags, endpoint identity groups, and so on in **Portal Settings**, and define behavior that applies to the overall portal.
- Step 6** Update the following settings, which apply to each of the specific pages:
- **Acceptable Use Policy (AUP) Page Settings**—Require guests to accept an acceptable use policy.
 - **Post-Access Banner Page Settings**—Inform guests of their access status and any other additional actions, if required.

- **VLAN DHCP Release Page Settings**—Release the guest device IP address from the guest VLAN and renew it to access another VLAN on the network.
- **Authentication Success Settings**—Specify what guests should see once they are authenticated.
- **Support Information Page Settings**—Help guests provide information that the Help Desk can use to troubleshoot network access issues.

Step 7 Click **Save**. A system-generated URL displays as the **Portal test URL**, which you can use to access the portal and test it.

What to do next

You must authorize the portal in order to use it. You can also customize your portal either before or after you authorize it for use.

Create a Sponsored-Guest Portal

You can provide a Sponsored-Guest portal to enable designated sponsors to grant access to guests.

You can create a new Sponsored-Guest portal, or you can edit or duplicate an existing one. You can delete any Sponsored-Guest portal, including the default portal provided by Cisco ISE.

Any changes that you make to the Page Settings on the **Portal Behavior and Flow Settings** tab are reflected in the graphical flow in the Guest Flow diagram. If you enable a page, such as the AUP page, it appears in the flow and the guest will experience it in the portal. If you disable it, it is removed from the flow and the next enabled page displays for the guest.

All these page settings enable you to display an Acceptable Use Policy (AUP) for a guest and require its acceptance:

- Login Page Settings
- Acceptable Use Policy (AUP) Page Settings
- BYOD Settings

Before you begin

Ensure that you have the required certificates, external identity sources, and identity source sequences configured for use with this portal.

What to do next



Note The test portal does not support RADIUS sessions, so you won't see the entire portal flow for all portals. BYOD and Client Provisioning are examples of portals that depend on RADIUS sessions. For example, a redirect to an external URL will not work. If you have more than one PSN, ISE chooses the first active PSN.

You must authorize the portal in order to use it. You can also customize your portal either before or after you authorize it for use.

Create a Self-Registered Guest Portal

You can provide a Self-Registered Guest portal to enable guests to register themselves and create their own accounts so they can access the network. You can still require that these accounts be approved by a sponsor before access is granted.

You can create a new Self-Registered Guest portal, or you can edit or duplicate an existing one. You can delete any Self-Registered Guest portal, including the default portal provided by Cisco ISE.

Any changes that you make to the Page Settings on the **Portal Behavior and Flow Settings** tab are reflected in the graphical flow in the Guest Flow diagram. If you enable a page, such as the AUP page, it appears in the flow and the guest will experience it in the portal. If you disable it, it is removed from the flow and the next enabled page displays for the guest.

All these page settings enable you to display an Acceptable Use Policy (AUP) for a guest and require its acceptance:

- Login Page Settings
- Self-Registration Page Settings
- Self-Registration Success Page Settings
- Acceptable Use Policy (AUP) Page Settings
- BYOD Settings

Before you begin

Ensure that you have configured the required certificates, external identity sources, and identity source sequences for this portal.

What to do next



Note The test portal does not support RADIUS sessions, so you won't see the entire portal flow for all portals. BYOD and Client Provisioning are examples of portals that depend on RADIUS sessions. For example, a redirect to an external URL will not work. If you have more than one PSN, ISE chooses the first active PSN.

You must authorize the portal in order to use it. You can also customize your portal either before or after you authorize it for use.

Self-Registered Account Approval by a Sponsor

When you configure a registered guest to require approval of their account, Cisco ISE sends email to the approver to approve the account. The approver can either be the person being visited, or a sponsor user.

When the approver is a sponsor, you can configure the email to include links that deny or approve the account. The approval link contains a token, which ties the approval to the sponsor's email address. You can require the sponsor to authenticate, which ignores the token. The token can also time out, which requires the sponsor to authenticate before approving the account.

You configure account approval options on the Self-Registration Portal's **Registration Form Settings**. This feature is also called single-click sponsor approval.

When the sponsor opens the email, and clicks the approve link, the action varies depending on configuration of the approver.

If **Email approval request to** is configured as:

- **person being visited**

- And the guest account **does not** require authentication: A single click approves the account.
- And the guest account **does** require authentication: The sponsor is directed to the sponsor portal, where the sponsor must enter their credentials before they can approve the account.

- **Sponsor email addresses listed below:** Cisco ISE sends emails to all the provided email addresses. When one of those sponsors clicks the approve or deny link, they are directed to their sponsor portal. That sponsor enters their credentials, which are verified. If the sponsor group that they belong to allows them to approve the guest account, they can approve the account. If credentials fail, then Cisco ISE notifies the sponsor to log on to the sponsor portal, and approve the account manually.

Considerations

- If you are upgrading or restoring the database from previous version of Cisco ISE, you must manually insert approve or deny links. Open the Self-Registered guest portal and choose the Portal Page Customization tab. Scroll down and choose the Approval Request Email window. Click **Insert Approve/Deny Links** in the **Email Body** section of that window.
- Only Sponsor portals that authenticate with Active Directory and LDAP are supported. The sponsor group that the sponsor maps to must contain the Active Directory group that the sponsor belongs to.
- When there is a list of sponsors, the customization from the first portal is used, even if that is not the portal that the sponsor logs on to.
- The sponsor must use an HTML-capable email client to use the approve and deny links.
- If the email address for the sponsor is not for a valid sponsor, the approval email is not sent.

For more information about single-click sponsor approval, see the Cisco ISE community resource: [ISE Single Click Sponsor Approval FAQ](#). This document also has a link to a video that explains the entire process.

Configuring Account Approval Email Links

You can require that a self-registered guest is approved before gaining access to the network. Cisco ISE uses the email address of the person being visited to notify the approver. The approver is either the person being visited, or a sponsor. For more information about approval, see [Self-Registered Account Approval by a Sponsor, on page 460](#).

Authorize Portals

When you authorize a portal, you are setting up the network authorization profiles and rules for network access.

Before you begin

You must create a portal before you can authorize it.

-
- Step 1** Set up a special authorization profile for the portal.
- Step 2** Create an authorization policy rule for the profile.
-

Create Authorization Profiles

Each portal requires that you set up a special authorization profile for it.

Before you begin

If you do not plan to use a default portal, you must first create the portal so you can associate the portal name with the authorization profile.

What to do next

You should create a portal authorization policy rule that uses the newly created authorization profile.

Create Authorization Policy Rules for Hotspot and MDM Portals

To configure the redirection URL for a portal to use when responding to the users' (guests, sponsors, employees) access requests, define an authorization policy rule for that portal.

The url-redirect takes the following form based on the portal type, where:

ip:port : the IP address and port number

PortalID: the unique portal name

For a Hotspot Guest portal:

`https://ip:port/guestportal/gateway?sessionID=SessionIdValue&portal=PortalID&action=cwa&type=drw`

For a Mobile Device Management (MDM) portal:

`https://ip:port/mdmportal/gateway?sessionID=SessionIdValue&portal=PortalID&action=mdm`

-
- Step 1** Choose **Policy > Authorization** to create a new authorization policy rule under **Standard** policies. If you have already enabled Policy Sets, pick the Policy Set you plan to use for this portal, expand the Authorization Policy, and add a new rule.
- Step 2** For **Conditions**, select an endpoint identity group that you want to use for the portal validation. For example, for the Hotspot Guest portal, select the default **GuestEndpoints** endpoint identity group and, for the MDM portal, select the default **RegisteredDevices** endpoint identity group.
- Note** Reauthenticate and Terminate CoA types are supported by Hotspot Guest portals. You can use Network Access:UseCase EQUALS Guest Flow as one of the validation conditions in the Hotspot Guest authorization policy only when Reauthentication CoA type is chosen in the Hotspot Guest Portal.
- Step 3** For **Permissions**, select the portal authorization profile that you created.
-



Note While creating an authorization condition using a dictionary attribute with the MAC option enabled, such as RADIUS.Calling-Station-ID, you must use a Mac operator (for example, Mac_equals) to support different MAC formats.

Customize Guest Portals

You can customize the portal appearance and user (guests, sponsors, or employees as applicable) experience by customizing the portal themes, changing UI elements on the portal pages, and editing error messages and notifications that are displayed to the users. For more information about customizing portals, see [Customization of End-User Web Portals](#), on page 509.

Configure Periodic AUP Acceptance

Choose **Policy > AuthorizationPolicy > Policy Sets**, and create a new authorization rule at the top of the list that redirects the Guest user to a credentialed portal when the AUP period has expired. Use conditions to compare LastAUPAcceptanceHours against the desired maximum hours, for example, LastAUPAcceptanceHours > 8. You can check for a range of hours from 1 to 999.

What to do next

To verify that the endpoint has received the AUP settings:

- 1.
2. Click an endpoint to verify that the endpoint has the time that the AUP was last accepted (*AUPAcceptedTime*).

Sponsor Portals

The Sponsor portal is one of the primary components of Cisco ISE guest services. Using the Sponsor portal, sponsors can create and manage temporary accounts for authorized visitors to securely access the corporate network or the Internet. After creating a guest account, sponsors also can use the Sponsor portal to provide account details to the guest by printing, emailing, or texting. Before providing self-registering guests access to the company network, sponsors may be requested via email to approve their guests' accounts.

Managing Guest Accounts on the Sponsor Portal

Sponsor Portal Log on Flow

A sponsor group specifies a set of permissions that are assigned to a sponsor user. When a sponsor logs in to a sponsor portal:

1. ISE verifies the sponsor's credentials.

2. If the sponsor authenticates successfully, Cisco ISE searches all the available sponsor groups to find the sponsor groups that the sponsor belongs to. A sponsor matches or belongs to a sponsor group if both:
 - The sponsor is a member of one of the configured Member Groups.
 - If you are using Other Conditions, all the conditions evaluate to true for that sponsor.
3. If the sponsor belongs to a sponsor group, then that sponsor gets the permissions from that group. A sponsor can belong to more than one sponsor group, in which case the permissions from those groups are combined. If the sponsor does not belong to any sponsor group, then the login to the sponsor portal fails.

Sponsor groups and their permissions are independent of the sponsor portals. The same algorithm for matching sponsor groups is used, regardless of which sponsor portal the sponsor logs in to.

Using a Sponsor Portal

Use a Sponsor portal to create temporary guest accounts for authorized visitors to securely access your corporate network or the Internet. After creating guest accounts, you can use a Sponsor portal to manage these accounts and to provide account details to the guests.

On a Sponsor portal, the sponsor can create new guest accounts individually, or import a group of users from a file.



Note An ISE administrator authorized from an external identity store, such as Active Directory, can be part of a Sponsor group. However, internal administrator accounts, for example, the default "admin" account, cannot be part of a Sponsor group.

There are several ways to open a Sponsor portal:

- In the Administrators console, using the **Manage Accounts** link. On the Administrators console, click **Guest Access > Manage Accounts**. When you click **Manage Accounts**, you are assigned to the default sponsor group with access to ALL_ACCOUNTS. You can create new guest accounts, but those guests cannot be notified, because there is no email address available to receive the account activation request from the guest. A Sponsor with the same privileges who logs on to the sponsor portal, and searches for those accounts, can send notification.

This step requires that the FQDN that you configured on the sponsor portal's **Portal Behavior and Flow Settings** window is in your DNS server.

If you are accessing the Sponsor portal through a NAT firewall, the connection uses port 9002.

- In the Administrators console, on the Sponsor Portal configuration window. Click **Guest Access > Portals & Components > Sponsor Portals**, open a sponsor portal, and click the **Portal Test URL** link to the right of the **Description** field.
- In a browser, by opening the URL (FQDN) configured in the sponsor portal's **Portal Settings** window, which must be defined in your DNS server.

What to do Next

For information about how to use the Sponsor portal, see the Sponsor Portal User Guide for your version of ISE <https://www.cisco.com/c/en/us/support/security/identity-services-engine/products-installation-guides-list.html>.

Managing Sponsor Accounts

A sponsor user is an employee or contractor of your organization who creates and manages guest-user accounts through the sponsor portal. Cisco ISE authenticates sponsors through a local database, or through external Lightweight Directory Access Protocol (LDAP), Microsoft Active Directory, or SAML identity stores. If you are not using an external source, you must create internal user accounts for sponsors.

Sponsor Groups

Sponsor groups control the permissions given to a sponsor when using any Sponsor portal. If a sponsor is a member of a sponsor group, then the sponsor receives the permissions defined in the group.

A sponsor is considered to be a member of a sponsor group if **both** of the following are true:

1. The sponsor belongs to at least one of the Member Groups defined in the sponsor group. A Member Group can be a User Identity Group, or a group selected from an external identity source, such as Active Directory.
2. The sponsor satisfies all of the Other Conditions specified in the sponsor group. The Other Conditions, which are optional, are conditions defined on dictionary attributes. These conditions are similar in behavior to those used in an Authorization Policy.

A sponsor can be a member of more than one sponsor group. If so, the sponsor receives the combined permissions from all of those groups, as follows:

- An individual permission such as "Delete guests' accounts" is granted if it is enabled in any of the groups.
- The sponsor can create guests using the Guest Types in any of the groups.
- The sponsor can create guests at the locations in any of the groups.
- For a numeric value such as a batch size limit, the largest value from the groups is used.


If a sponsor is not a member of any sponsor group, then the sponsor is not permitted to log in to any sponsor portal.

- ALL_ACCOUNTS: Sponsors can manage all guest accounts.
- GROUP_ACCOUNTS: Sponsors can manage the guest accounts created by sponsors from the same Sponsor Group.
- OWN_ACCOUNTS: Sponsors can manage only the Guest accounts that they created.

You can customize the features available to particular sponsor groups to limit or expand the functionality of the Sponsor portal.

Create Sponsor Accounts and Assign to Sponsor Groups

To create internal sponsor user accounts and specify the sponsors who can use the Sponsor portals:

-
- Step 1** **Note** The default Sponsor Groups have the default Identity Group Guest_Portal_Sequence assigned to them.
- Step 2** Choose In the Cisco ISE GUI, click the **Menu** icon () and choose **Work Centers > Guest Access > Portals & Components > Sponsor Groups > Create, Edit or Duplicate** and click **Members**. Map the sponsor user identity groups to sponsor groups.
-

What to do next

You can also create additional user identity groups specific to your organization to use with sponsors. Choose **Administration > Identity Management > Groups > User Identity Groups**.

Configure Sponsor Groups

Cisco provides default sponsor groups. If you do not want to use the default options, you can either create new sponsor groups or edit the default sponsor groups and change the settings. You can also duplicate a sponsor group to create more sponsor groups with the same settings and privileges.

You can disable a sponsor group, which prevents the members of the sponsor group from logging in to the Sponsor portal. You can delete any of the sponsor groups, except the default sponsor groups provided by Cisco ISE.

Step 1 Choose **Work Centers > Guest Access > Portals and Components > Sponsor Groups > Create, Edit or Duplicate**.

Step 2 Enter the **Sponsor group name** and **Description**.

Step 3 Enter the following details in the **Match Criteria** section:

- **Member Groups:** Click **Members** to select one or more user (identity) groups and groups from external identity sources, and add those groups. In order for a user to be a member of this sponsor group, they must belong to at least one of the configured groups.
- **Other conditions:** Click **Create New Condition** to build one or more conditions that a sponsor must match to be included in this sponsor group. You can use authentication attributes from Active Directory, LDAP, SAML, and ODBC identity stores, but not RADIUS Token or RSA SecurID stores. You can also use internal user attributes. Conditions have an attribute, and operator, and a value.
 - To create a condition using the internal dictionary attribute *Name*, prefix the identity group name with User Identity Groups. For example:


```
InternalUser:Name EQUALS bsmith
```

This means that only internal users with the Name "bsmith" can belong to this sponsor group.
 - To create a condition using the ExternalGroups attribute of an Active Directory instance, select the AD “Primary Group” for the sponsor users you want to match. For example, *AD1:LastName EQUALS Smith* is true if the user’s name is Smith.

In addition to matching one or more of the configured member groups, a sponsor must also match **all** the conditions you create here. If an authenticating sponsor user meets the matching criteria for multiple sponsor groups, then that user is granted permissions as follows:

- An individual permission, such as Delete guests' accounts is granted if it is enabled in any of the matching groups.
- The sponsor can create guests using the Guest Types in any of the matching groups.
- The sponsor can create guests using the Guest Types in any of the matching groups.
- The sponsor can create guests at the locations in any of the matching groups.
- For a numeric value such as a batch size limit, the largest value from the matching groups is used.

You can create Matching Criteria that contain Member Groups only, or Other Conditions only. If you only specify Other Conditions, then membership of a sponsor in the sponsor group is determined solely by matching dictionary attributes.

- Step 4** To specify which guest types that sponsors based on this sponsor group can create, click **This sponsor group can create accounts using these guest types**, and select one or more guest types.
- You can create more guest types to assign to this sponsor group by clicking the link under **Create Guest Types at**. After you create a new guest type, save, close, and reopen the sponsor group before you can select that new guest type.
- Step 5** Use **Select the locations that guests will be visiting** to specify the locations (used to set the guest time zones) that sponsors in this sponsor group can choose from when creating guest accounts.
- You can add more locations to choose from by clicking the link under **Configure guest locations at** and adding guest locations. After you create a new guest location, save, close, and reopen the sponsor group before you can select that new guest location.
- This does not restrict guests from logging in from other locations.
- Step 6** Under **Automatic guest notification**, check **Automatically email guests upon account creation if email address is available** if you want to save your sponsors the step of clicking **Notify** after creating a user. This causes a window to popup saying that an email was sent. Checking this also adds a header to the sponsor portal that says **Guest notifications are sent automatically**.
- Step 7** Under **Sponsor Can Create**, configure options that sponsors in this group have for creating guest accounts.
- **Multiple guest accounts assigned to specific guests (Import)**: Enable the sponsor to create multiple guest accounts by importing guest details such as first name and last name from a file.
If this option is enabled, the **Import** option appears on the **Create Accounts** window of the Sponsor portal. The Import option is only available on desktop browsers (not mobile), such as Internet Explorer, Firefox, Safari, and so forth
 - **Limit to batch of**: If this sponsor group is allowed to create multiple accounts simultaneously, specify the number of guest accounts that can be created in a single import operation.
Although a sponsor can create a maximum of 10,000 accounts, we recommend that you limit the number of accounts you create, due to potential performance issues.
 - **Multiple guest accounts to be assigned to any guests (Random)**: Enable the sponsor to create multiple random guest accounts as placeholders for guests who are not known as yet, or to create many accounts quickly.
If this option is enabled, the **Random** option appears on the **Create Accounts** window of the Sponsor portal.
 - **Default username prefix**: Specify a username prefix that sponsors can use when creating multiple random guest accounts. If specified, this prefix appears in the Sponsor Portal when creating random guest accounts. In addition, if **Allow sponsor to specify a username prefix** is:
 - Enabled: The sponsor can edit the default prefix in the Sponsor portal.
 - Not enabled: The sponsor cannot edit the default prefix in the Sponsor portal.If you do not specify a username prefix or allow the sponsor to specify one, then the sponsor will not be able to assign username prefixes in the Sponsor portal.
 - **Allow sponsor to specify a username prefix**: If this sponsor group is allowed to create multiple accounts simultaneously, specify the number of guest accounts that can be created in a single import operation.
Although a sponsor can create a maximum of 10,000 accounts, we recommend that you limit the number of accounts you create, due to potential performance issues.
- Step 8** Under **Sponsor Can Manage**, you can restrict which guests accounts the members of this sponsor group can view and manage.

- **Only accounts sponsor has created:** Sponsors in this group can view and manage only the guest accounts that they have created, which is based on the Sponsor's email account.
- **Accounts created by members of this sponsor group:** Sponsors in this group can view and manage the guest accounts created by any sponsor in this sponsor group.
- **All guest accounts:** Sponsors view and manage all pending guest accounts.

Step 9

Under **Sponsor Can**, you can provide more privileges related to guest passwords and accounts to the members of this sponsor group.

- **Update guests' contact information (email, Phone Number):** For guest accounts that they can manage, allow the sponsor to change a guest's contact information
- **View/print guests' passwords:** When this option is enabled, the sponsor can print passwords for guests. The sponsor can see the passwords for guests on the **Manage Accounts** window and in the details for a guest. When this is not checked, the sponsor can't print the password, but the user can still get the password through email or SMS, if configured.
- **Send SMS notifications with guests' credentials:** For guest accounts that they can manage, allow the sponsor to send SMS (text) notifications to guests with their account details and login credentials.
- **Reset guest account passwords:** For guest accounts that they can manage, allow the sponsor to reset passwords for guests to a random password generated by Cisco ISE.
- **Extend guests' accounts:** For guest accounts that they can manage, allow the sponsor to extend them beyond their expiration date. The sponsor is automatically copied on email notifications sent to guests regarding their account expiration.
- **Delete guests' accounts:** For guest accounts that they can manage, allow the sponsor to delete the accounts, and prevent guests from accessing your company's network.
- **Suspend guests' accounts:** For guest accounts that they can manage, allow the sponsor to suspend their accounts to prevent guests from logging in temporarily.

This action also issues a Change of Authorization (CoA) Terminate to remove the suspended guests from the network.

- **Require sponsor to provide a reason:** Require the sponsor to provide an explanation for suspending the guest accounts.
- **Approve and view requests from self-registering guests:** Sponsors who are included in this Sponsor Group can either view all pending account requests from self-registering guests (that require approval), or only the requests where the user entered the Sponsor's email address as the person being visited. This feature requires that the portal used by the Self-registering guest has **Require self-registered guests to be approved** checked, and the Sponsor's email is listed as the person to contact.
 - Any pending accounts: A sponsor belonging to this group can approve and review accounts that were created by any sponsor.
 - Only pending accounts assigned to this sponsor: A sponsor belonging to this group can only view and approve accounts that they created.
- **Access Cisco ISE guest accounts using the programmatic interface (Guest REST API):** For guest accounts that they can manage, allow the sponsor to access guest accounts using the Guest REST API programming interface.

Step 10 Click **Save** and then **Close**.

Configure Account Content for Sponsor Account Creation

You can configure the type of user data that your guests and sponsors must provide to create a new guest account. Some fields are required to identify an ISE account, but you can eliminate other fields, and add your own custom fields.

To configure fields for account creation by Sponsors:

1. Choose **Work Centers > Guest Access > Portals & Components > Sponsor Portals**, and edit your sponsor portal.
2. Select the **Portal Page Customization** tab.
3. Scroll down and select **Create Account for Known Guests**.
4. On the Preview display on the right, select **Settings**.

These settings determine which fields display and are required for guest accounts when they are created on the sponsor portal. This configuration applies to Known, Random, and Imported guest types. The template that the sponsor downloads to import new users is created dynamically, so that only the fields set in Known Guests are included.

Import Username and Password for Accounts

Sponsors can import username and password, but those rows are not added to the CSV template when the sponsor downloads it. The sponsor can add those headings. They must be named properly in order for the ISE to recognize the columns:

- Username—Can be either *User Name* or *UserName*.
- Password—Must be **password**.

Special Settings for the Sponsor Portal

The following settings are unique to the Create Account for Imported Guests page, on the Portal Page Customization tab, on the Sponsor Portal.

- **Allow sponsor to be copied in Guest Credentials email:** If you enable this option, then each email of guest credentials that is sent to a successfully imported guest is also sent to the sponsor. The default is to not send emails to the sponsor.
- **Allow sponsor to receive summary email:** When a sponsor imports a list of users, ISE sends one email with a summary of all the imported users. If you uncheck this option, the sponsor gets a separate email for each imported user.

Configure a Sponsor Portal Flow

You can use a default portal and its default settings such as certificates, endpoint identity group, identity source sequence, portal themes, images, and other details provided by Cisco ISE. If you do not want to use the default settings, you should create a new portal or edit an existing one to meet your needs. You can duplicate a portal if you want to create multiple portals with the same settings.

You may want to create multiple sponsor portals if your company has different branding for your corporate office and its retail locations, or if your company has different product brands, or if a city's offices want different themed portals for the fire, police, and other departments.

These are the tasks related to configuring a Sponsor portal.

Before you begin

Configure or edit existing sponsor groups for your site, as described in [Configure Sponsor Groups, on page 466](#).

-
- Step 1** [Enable Policy Services, on page 470](#).
 - Step 2** [Add Certificates for Guest Services, on page 470](#).
 - Step 3** [Create External Identity Sources, on page 470](#).
 - Step 4** [Create Identity Source Sequences, on page 471](#).
 - Step 5** [Create a Sponsor Portal, on page 472](#).
 - Step 6** (Optional) [Customize Sponsor Portals, on page 472](#).
-

Enable Policy Services

To support the Cisco ISE end-user web portals, you must enable the portal-policy services on the node on which you want to host them.

-
- Step 1** Choose **Administration** > **System** > **Deployment**.
 - Step 2** Click the node and click **Edit**.
 - Step 3** Under the **General Settings** tab, check the **Policy Service** check box.
 - Step 4** Check the **Enable Session Services** check box.
 - Step 5** Click **Save**.
-

Add Certificates for Guest Services

If you do not want to use the default certificates, you can add a valid certificate and assign it to a certificate group tag. The default certificate group tag used for all end-user web portals is Default Portal Certificate Group.

Create External Identity Sources

Cisco ISE can connect with external identity sources such as Active Directory, LDAP, RADIUS Token, and RSA SecurID servers to obtain user information for authentication and authorization. External identity sources also include certificate authentication profiles that you need for certificate-based authentications.



Note To work with passive identity services, which enable you to receive and share authenticated user identities, see [Additional Passive Identity Service Providers, on page 369](#).

Step 1 Choose **Administration > Identity Management > External Identity Sources**.

Step 2 Choose one of these options:

- **Certificate Authentication Profile** for certificate-based authentications.
 - **Active Directory** to connect to an Active Directory as an external identity source. See [Active Directory as an External Identity Source, on page 323](#) for more details.
 - **LDAP** to add an LDAP identity source. See [LDAP, on page 409](#) for more details.
 - **RADIUS Token** to add a RADIUS Token server. See [RADIUS Token Identity Sources, on page 423](#) for more details.
 - **RSA SecurID** to add an RSA SecurID server. See [RSA Identity Sources, on page 428](#) for more details.
 - **SAML Id Providers** to add an identity provider (IdP), such as Oracle Access Manager. See [SAMLv2 Identity Provider as an External Identity Source, on page 432](#) for more details.
-

Create Identity Source Sequences

Before you begin

Ensure that you have configured your external identity sources in Cisco ISE.

To perform the following task, you must be a Super Admin or System Admin.

For allowing guest users to authenticate through Local WebAuth, you must configure both the Guest portal authentication source and the identity source sequence to contain the same identity stores.

Step 1 Choose **Administration > Identity Management > Identity Source Sequences > Add**.

Step 2 Enter a name for the identity source sequence. You can also enter an optional description.

Step 3 Check the **Select Certificate Authentication Profile** check box and choose a certificate authentication profile for certificate-based authentication.

Step 4 Choose the database or databases that you want to include in the identity source sequence in the **Selected List** field.

Step 5 Rearrange the databases in the **Selected list** field in the order in which you want Cisco ISE to search the databases.

Step 6 Choose one of the following options in the **Advanced Search List** area:

- **Do not access other stores in the sequence and set the AuthenticationStatus attribute to ProcessError:** Choose this option if you want Cisco ISE to discontinue the search, if the user is not found in the first selected identity source.
- **Treat as if the user was not found and proceed to the next store in the sequence:** Choose this option if you want Cisco ISE to continue searching the other selected identity sources in sequence, if the user is not found in the first selected identity source.

While processing a request, Cisco ISE searches these identity sources in sequence. Ensure that you have the identity sources in the Selected list field listed in the order in which you want Cisco ISE to search them.

Step 7 Click **Submit** to create the identity source sequence that you can then use in policies.

Create a Sponsor Portal

You can provide a Sponsor portal to enable sponsors to create, manage, and approve accounts for guests who want to connect to your network to access the internet and internal resources and services.

Cisco ISE provides you with a default Sponsor portal that you can use without having to create another one. However, you can create a new Sponsor portal, or you can edit or duplicate an existing one. You can delete any of these portals, except the default Sponsor portal.

Any changes that you make to the Page Settings on the **Portal Behavior and Flow Settings** tab are reflected in the graphical flow in the Sponsor Flow diagram. If you enable a page, such as the AUP page, it appears in the flow and the sponsor will experience it in the portal. If you disable it, it is removed from the flow and the next enabled page displays for the sponsor.

Before you begin

Ensure that you have the required certificates, external identity sources, and identity source sequences configured for use with this portal.

-
- Step 1** Configure the **Portal Settings** page, as described in [Portal Settings for Sponsor Portals, on page 940](#). Ensure that the portal name that you use here is not used for any other end-user portals.
 - Step 2** Configure the **Login Settings** page, as described in [Login Settings for Sponsor Portals, on page 943](#).
 - Step 3** Configure the **Acceptable Use Policy (AUP) Page Settings** page, as described in [Acceptable Use Policy \(AUP\) Settings for Sponsor Portals, on page 943](#).
 - Step 4** Configure the **Sponsor Change Password Settings** option, as described in [Sponsor Change Password Settings for Sponsor Portals, on page 944](#).
 - Step 5** Configure the **Post-Login Banner Page Settings** page, as described in [Post-Login Banner Settings for Sponsor Portals, on page 944](#).
 - Step 6** Click **Sponsor Portal Application Settings** if you want to customize the portal.
 - Step 7** Click **Save**.
-



Note When using LDAP and SAML GuestID store as identity stores to login into the Sponsor portal, we recommend you to use the sponsor email address to login. If you login with the sponsor ID you might not be able to see the approved users.

Customize Sponsor Portals

You can customize the portal appearance and user experience by customizing the portal themes, changing UI elements on the portal pages, and editing error messages and notifications that display to the users. For more information about customizing portals, see [Customization of End-User Web Portals, on page 509](#).

Configuring Account Content for Sponsor Account Creation

You can configure the type of user data that your guests and sponsors must provide to create a new guest account. Some fields are required to identify an ISE account, but you can eliminate other fields, and add your own custom fields.

To configure fields for account creation by Sponsors:

1. Choose **Work Centers > Guest Access > Portals & Components > Sponsor Portals**, and edit your sponsor portal.
2. Select the **Portal Page Customization** tab.
3. Scroll down and select **Create Account for Known Guests**.

On the Preview display on the right, select **Settings**. These settings determine which fields display and are required for guest accounts when they are created on the sponsor portal.

This configuration applies to Known, Random, and Imported guest types. The template that the sponsor downloads to import new users is created dynamically, so that only the fields set in Known Guests are included.

Sponsor Import Usernames and Passwords for Accounts

Sponsors can import username and password, but those rows are not added to the template when the sponsor downloads it. The sponsor can add those headings. They must be named properly in order for the Cisco ISE to recognize the columns:

- **Username:** Can be either **User Name** or **UserName**
- **Password:** Must be password

Configuring the Time Settings Available to Sponsors

When sponsors create a new guest account, they configure the time that the account is active. You configure the options that are available to the sponsor, to allow them to set the account duration, and the start and end times. These options are configured by guest type. The sponsor sees the results under the heading **Access Information**.

The Guest Type settings that control sponsor portal account time options are under the heading **Maximum Access Time**, and are described below:

- **From first login:** The sponsor portal shows the duration for which the account is active after the first login.

Access Information

Duration:*

Days (Maximum:365)

FromFirst Login

Create

The guest type setting **Maximum Account Duration** determines which values the Sponsor can enter for duration.

- **From sponsor-specified date (or date of self-registration, if applicable):** The sponsor can choose between setting the duration as End of business day, or, by unchecking that field, the duration, start and end times.

Access Information End of business day

23:59

Duration:*

90 Days (Maximum:365)

From Date (yyyy-mm-dd) *

2017-02-08

From Time *

10:52

To Date (yyyy-mm-dd) *

2017-05-09

To Time *

11:52

Create

The guest type settings to control the duration time and effective dates are under the heading **Allow access only on these days and times**.

- The days of the week that you select limits the dates that are selectable in the Sponsor's calendar.
- Maximum account duration is enforced in the sponsor portal when picking duration and dates.

Sponsors Cannot Log In to the Sponsor Portal**Problem**

The following error message appears when a sponsor tries to log in to the Sponsor portal:

```
"Invalid username or password. Please try again."
```

Causes

- The sponsor has entered invalid credentials.
- The sponsor is not valid because the user record is not present in the database (Internal Users or Active Directory).
- The sponsor group to which the sponsor belongs is disabled.
- The Sponsor's user account is not a member of an active/enabled Sponsor Group, which means the Sponsor user's Identity Group is not a member of any Sponsor Group.
- The sponsor's internal user account is disabled (suspended).

Solution

- Verify the user's credentials.

- Enable the sponsor group.
- Reinstate the user account if disabled.
- Add the sponsor user's Identity Group as a member of a Sponsor Group.

Monitor Guest and Sponsor Activity

Cisco ISE provides various reports and logs that allow you to view endpoint and user management information and guest and sponsor activity.

You can run these reports either on demand or on a scheduled basis.

-
- Step 1** Choose **Operations > Reports > Reports**.
 - Step 2** Choose **Guest** or **Endpoints and Users** to view the various guest, sponsor, and endpoint related reports
 - Step 3** Choose the data with which you want to search using the **Filters** drop-down list.
 - Step 4** Select the **Time Range** during which you want to view the data.
 - Step 5** Click **Run**.
-

Metrics Dashboard

Cisco ISE provides an at-a-glance view of **Authenticated Guests** and **Active Endpoints** in the network in a metrics dashboard that appears on the Cisco ISE Home page.



Note For Hotspot flow, the endpoints are not displayed on the **Authenticated Guests** dashlet

AUP Acceptance Status Report

You can use the report to track all the accepted and denied AUP connections for a given period of time.

Guest Accounting Report

The Guest Accounting report displays the guest login history for an indicated time period. This report is available at: **Operations > Reports > Guest Access Reports > Guest Accounting**.

Master Guest Report

The Master Guest Report combines data from various reports into a single view enabling you to export data from different reporting sources. You can add more data columns and remove the ones you do not want to view or export. This report is available at **Operations > Reports > Reports > Guest > Master Guest Report**.

This report collects all guest activity and provides details about the websites that guest users visit. You can use this report for security auditing purposes to see when guest users accessed the network and what they did on it. To view the guests' Internet activity, such as the URLs of the websites that they visited, you must first:

-
- Enable these options on the firewall used for guest traffic:
 - Inspect HTTP traffic and send data to Cisco ISE Monitoring node. Cisco ISE requires only the IP address and accessed URL for the Guest Activity report; so, limit the data to include just this information, if possible.
 - Send syslogs to Cisco ISE Monitoring node.

Sponsor Login and Audit Report

The Sponsor Login and Audit report is a combined report that tracks:

- Login activity by the sponsors at the Sponsor portal.
- Guest-related operations performed by the sponsors in the Sponsor portal.

Audit Logging for Guest and Sponsor Portals

During specific actions within the Guest and Sponsor portals, audit log messages are sent to the underlying audit system. By default, these messages appear in the `/opt/CSCOcpm/logs/localStore/iseLocalStore.log` file.

You can configure these messages to be sent by syslog to the monitoring and troubleshooting system and log collector. The monitoring subsystem presents this information in the appropriate sponsor and device audit logs and guest activity logs.

Guest login flow is logged in the audit logs regardless of whether the guest login has passed or failed.

Guest Access Web Authentication Options

Cisco ISE Guest and Web Authentication Services support several deployment options that enable secure guest access. You can provide wired or wireless guest connectivity using Local or Central Web Authentication and Device Registration Web Authentication.

- Central Web Authentication (Central WebAuth): Applies to all Guest portals. Uses Web authentication by a central Cisco ISE RADIUS server for both wired and wireless connection requests. Guests authenticate after by either entering an optional access code on the Hotspot Guest portals, or by entering a username and password on the Credentialed Guest portals.



Note During redirection, if the browser opens more than one tab, Cisco ISE redirects to every tab. The user can log in to the portal, but Cisco ISE can't authorize the session, and the user fails to gain access. To work around this issue, the user must close all but one tab on the browser.

- Local Web Authentication (Local WebAuth): Applies to the Credentialed Guest portals. The guest connects to a switch for a wired connections, or a wireless LAN controller (WLC) for a wireless connection. The network access device (NAD) directs them to web pages for authentication. The guest enters a username and password on the Credentialed Guest portals to authenticate.
- Device Registration Web Authentication (Device Registration WebAuth): Applies only to the Hotspot Guest portal. Cisco ISE registers and authorizes the guest device before Web authentication. When guests connect to a wired or wireless NAD, they are directed to the Hotspot Guest portal. Guests get network access without providing credentials (username and password).

ISE Community Resource

For information on how to configure Cisco ISE with Cisco Wireless Controller to provide guest access, see [ISE Guest Access Prescriptive Deployment Guide](#).

Also see the following Tech Note: [ISE Wireless Guest Setup Guide & Wizard](#).

NAD with Central WebAuth Process

In this scenario, the network access device (NAD) makes a new authorization request to the Cisco ISE RADIUS server from an unknown endpoint connection. The endpoint then receives a url-redirect to Cisco ISE.



Note webauth-vrf-aware command is supported only in IOS XE 3.7E, IOS 15.2(4)E or later versions. Other switches do not support WebAuth URL redirect in virtual routing and forwarding (VRF) environment. In such cases, as a workaround, you can add a route in the global routing table to leak the traffic back into the VRF.

If the guest device is connected to a NAD, the guest service interaction takes the form of a MAC Authentication Bypass (MAB) request that leads to a Guest portal Central WebAuth login. The following is an outline of the subsequent Central Web Authentication (Central WebAuth) process, which applies to both wireless and wired network access devices.

1. The guest device connects to the NAD through a hard-wired connection. There is no 802.1X supplicant on the guest device.
2. An authentication policy with a service type for MAB allows a MAB failure to continue and return a restricted network profile containing a url-redirect for the Central WebAuth user interface.
3. The NAD is configured to authenticate MAB requests to the Cisco ISE RADIUS server.
4. The Cisco ISE RADIUS server processes the MAB request and does not find an endpoint for the guest device.

This MAB failure resolves to the restricted network profile and returns the url-redirect value in the profile to the NAD in an access-accept. To support this function, ensure that an authorization policy exists and features the appropriate wired or wireless MAB (under compound conditions) and, optionally, “Session:Posture Status=Unknown” conditions. The NAD uses this value to redirect all guest HTTPS traffic on the default port 8443 to the url-redirect value.

The standard URL value in this case is:

```
https://ip:port/guestportal/gateway?sessionId=NetworkSessionId&portal=<PortalID>&action=cwa
```

5. The guest device initiates an HTTP request to redirect URL via a web browser.

6. The NAD redirects the request to the url-redirect value returned from the initial access-accept.
7. The gateway URL value with action CWA redirects to the Guest portal login page.
8. The guest enters their login credentials and submits the login form.
9. The guest server authenticates the login credentials.
10. Depending on the type of flow, the following occurs:
 - If it is a non-posture flow (authentication without further validation), where the Guest portal is not configured to perform client provisioning, the guest server sends a CoA to the NAD. This CoA causes the NAD to reauthenticate the guest device using the Cisco ISE RADIUS server. A new access-accept is returned to the NAD with the configured network access. If client provisioning is not configured and the VLAN needs to be changed, the Guest portal performs VLAN IP renew. The guest does not have to re-enter login credentials. The username and password entered for the initial login are used automatically.
 - If it is a posture flow, where the Guest portal is configured to perform client provisioning, the guest device web browser displays the Client Provisioning page for posture agent installation and compliance. (You can also optionally configure the client provisioning resource policy to feature a “NetworkAccess:UseCase=GuestFlow” condition.)

The Guest portal redirects to the Client Provisioning portal (because there is no client provisioning or posture agent for Linux), which in turn redirects back to a guest authentication servlet to perform optional IP release/renew and then CoA.

With redirection to the Client Provisioning portal, the Client Provisioning service downloads a non-persistent web agent to the guest device and performs a posture check of the device. You can optionally configure the posture policy with a “NetworkAccess:UseCase=GuestFlow” condition.

If the guest device is non-compliant, ensure that you have configured an authorization policy that features “NetworkAccess:UseCase=GuestFlow” and “Session:Posture Status=NonCompliant” conditions.

When the guest device is compliant, ensure that you have an authorization policy configured with the conditions “NetworkAccess:UseCase=GuestFlow” and “Session:Posture Status=Compliant.” From here, the Client Provisioning service issues a CoA to the NAD. This CoA causes the NAD to reauthenticate the guest using the Cisco ISE RADIUS server. A new access-accept is returned to the NAD with the configured network access.



Note “NetworkAccess:UseCase=GuestFlow” can also apply for Active Directory and LDAP users who log in as guests.

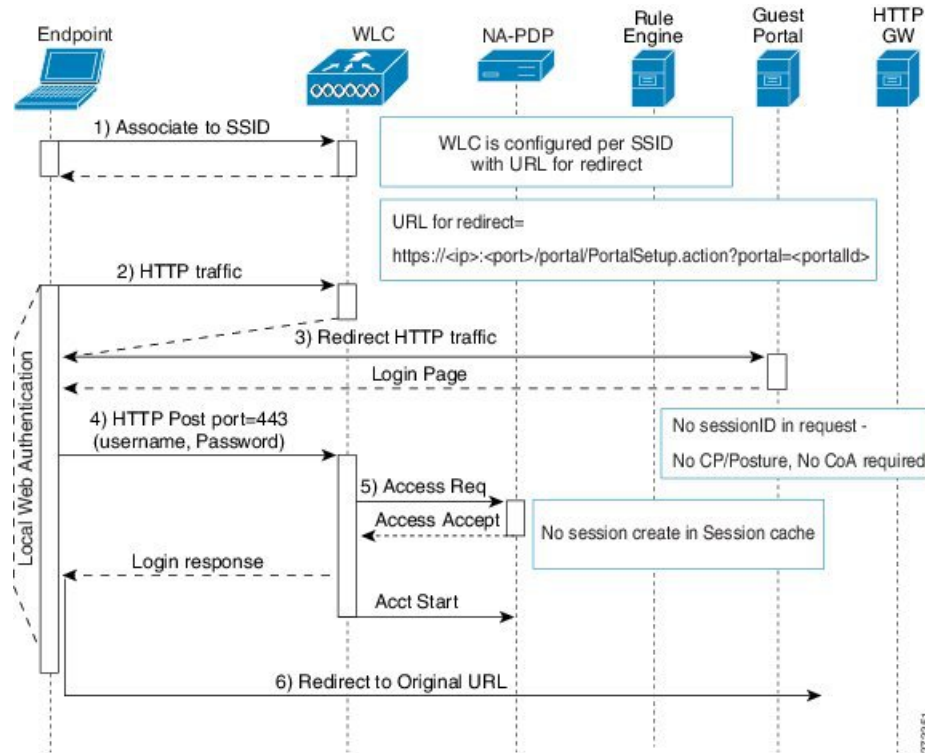
Wireless LAN Controller with Local WebAuth Process

In this scenario, the guest logs in and is directed to the wireless LAN controller (WLC). The WLC then redirects the guest to a Guest portal, where they are prompted to enter their login credentials, accept an optional Acceptable Use Policy (AUP), and perform an optional password change. When this is complete, the guest device’s browser is redirected back to the WLC to provide login credentials via a POST.

The WLC can now log the guest in via the Cisco ISE RADIUS server. When this is complete, the WLC redirects the guest device's browser to the original URL destination. The Wireless LAN Controller (WLC)

and the network access devices (NAD) requirements to support the original URL redirect for guest portals are WLC 5760 and Cisco Catalyst 3850, 3650, 2000, 3000, and 4000 Series Access Switches running releases IOS-XE 3.6.0.E and 15.2(2)E.

Figure 44: WLC with Local WebAuth Non-Posture Flow



Wired NAD with Local WebAuth Process

In this scenario, the Guest portal redirects the guest login request to the switch (wired NAD). The login request is in the form of an HTTPS URL posted to the switch and contains the login credentials. The switch receives the guest login request and authenticates the guest using the configured Cisco ISE RADIUS server.

1. Cisco ISE requires a login.html file with the HTML redirect to be uploaded to the NAD. This login.html file is returned to the browser of the guest device for any HTTPS request made.
2. The browser of the guest device is redirected to the Guest portal where the guest's login credentials are entered.
3. After the Acceptable Use Policy (AUP) and change password are processed, both of which are optional, the Guest portal redirects the browser of the guest device to post the login credentials on the NAD.
4. The NAD makes a RADIUS request to the Cisco ISE RADIUS server to authenticate and authorize the guest.

IP Address and Port Values Required for the Login.html Page

The IP address and port values must be changed in the following HTML code for the login.html page to those values being used by the Cisco ISE Policy Services nodes. The default port is 8443, but you can change this value, so ensure that the value you assign to the switch matches the setting in Cisco ISE.

```
<!DOCTYPE HTML PUBLIC "-//W3C//DTD HTML 4.0 Transitional//EN">
<HTML>
<head>
<title>ISE Guest Portal</title>
<meta Http-Equiv="Cache-Control" Content="no-cache">
<meta Http-Equiv="Pragma" Content="no-cache">
<meta Http-Equiv="Expires" Content="0">
<meta http-equiv="content-type" content="text/html; charset=ISO-8859-1">

<meta http-equiv="REFRESH"
content="0;url=https://ip:port/portal/PortalSetup.action?switch_url=wired">

</HEAD>
<BODY>

<center>
Redirecting ... Login
<br>
<br>
<a href="https://ip:port/portal/PortalSetup.action?switch_url=wired">ISE Guest Portal</a>
</center>

</BODY>
</HTML>
```

The custom login page is a public web form, hence consider these guidelines:

- The login form must accept user entries for the username and password and must show them as **uname** and **pwd**.
- The custom login page should follow best practices for a web form, such as page timeout, hidden password, and prevention of redundant submissions.

HTTPS Server Enabled on the NAD

To use web-based authentication, you must enable the HTTPS server within the switch using the **ip http secure-server** command.

Support for Customized Authentication Proxy Web Pages on the NAD

You can upload custom pages for success, expiry, and failure to the NAD. Cisco ISE does not require any specific customization, so you can create these pages using the standard configuration instructions included with the NAD.

Configure Web Authentication on the NAD

You need to complete the web authentication on the NAD by replacing the default HTML pages with your custom files.

Before you begin

During web-based authentication, create four substitute HTML pages to use instead of the switch default HTML pages.

Step 1 To specify the use of your custom authentication proxy web pages, first store your custom HTML files on the switch flash memory. To copy your HTML files to the switch flash memory, run the following command on the switch:

copy tftp/ftp flash

Step 2 After copying your HTML files to the switch, perform the following commands in global configuration mode:

ip admission proxy http login page file <i>device:login-filename</i>	Specifies the location in the switch memory file system of the custom HTML file to use in place of the default login page. The device: is flash memory.
ip admission proxy http success page file <i>device:success-filename</i>	Specifies the location of the custom HTML file to use in place of the default login success page.
ip admission proxy http failure page file <i>device:fail-filename</i>	Specifies the location of the custom HTML file to use in place of the default login failure page.
ip admission proxy http login expired page file <i>device:expired-filename</i>	Specifies the location of the custom HTML file to use in place of the default login expired page.

Step 3 Configure the customized authentication proxy web pages following the guidelines provided by the switch.

Step 4 Verify the configuration of a custom authentication proxy web page, as shown in the following example:

```
Switch# show ip admission configuration
Authentication proxy webpage
Login page           : flash:login.htm
Success page        : flash:success.htm
Fail Page           : flash:fail.htm
Login expired Page  : flash:expired.htm

Authentication global cache time is 60 minutes
Authentication global absolute time is 0 minutes
Authentication global init state time is 2 minutes
Authentication Proxy Session ratelimit is 100
Authentication Proxy Watch-list is disabled
Authentication Proxy Auditing is disabled
Max Login attempts per user is 5
```

Device Registration WebAuth Process

Using Device Registration Web Authentication (Device Registration WebAuth) and the Hotspot Guest portal, you can allow guest devices to connect to a private network without requiring usernames and passwords.

In this scenario, the guest connects to the network with a wireless connection. See [Figure 45: Wireless Device Registration Web Authentication Flow](#) for an example of the Device Registration WebAuth process flow.

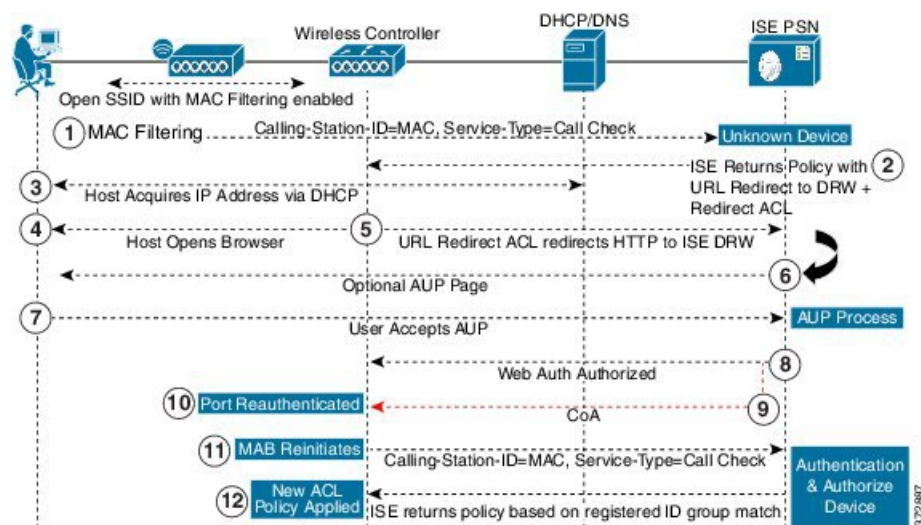
The following is an outline of the subsequent Device Registration WebAuth process, which is similar for both wireless and wired connections:

1. The network access device (NAD) sends a redirect to the Hotspot Guest portal.
2. If the MAC address of the guest device is not in any endpoint identity group or is not marked with an Acceptable Use Policy (AUP) accepted attribute set to true, Cisco ISE responds with a URL redirection specified in an authorization profile.
3. The URL redirection presents the guest with an AUP page (if enabled) when the guest attempts to access any URL.
 - If the guest accepts the AUP, the endpoint associated with their device MAC address is assigned to the configured endpoint identity group. This endpoint is now marked with an AUP accepted attribute set to true, to track the guest acceptance of the AUP.
 - If the guest does not accept the AUP or if an error occurs, for instance, while creating or updating the endpoint, an error message displays.
4. Based on the Hotspot Guest portal configuration, a post-access banner page (if enabled) with additional information may appear.
5. After the endpoint is created or updated, a Change of Authorization (CoA) termination is sent to the NAD.
6. After the CoA, the NAD re-authenticates the guest connection with a new MAC Auth Bypass (MAB) request. The new authentication finds the endpoint with its associated endpoint identity group, and returns the configured access to the NAD.
7. Based on the Hotspot Guest portal configuration, the guest is directed to the URL to which they requested access, or to a custom URL specified by the administrator, or to an Authentication Success Page.

The CoA type for both wired and wireless is Termination CoA. You can configure the Hotspot Guest portal to perform VLAN DHCP Release (and renew), thereby re-authorizing the CoA type for both wired and wireless to Change of Auth.

VLAN DHCP Release support is available for Windows devices only. It is not available for mobile devices. If the device being registered is mobile and the VLAN DHCP Release option is enabled, the guest is requested to manually renew their IP address. For mobile device users, we recommend using Access Control Lists (ACLs) on the WLC, rather than using VLANs.

Figure 45: Wireless Device Registration Web Authentication Flow





CHAPTER 17

Support Device Access

- [Personal Devices on a Corporate Network \(BYOD\), on page 483](#)
- [Personal Device Portals, on page 484](#)
- [Support Device Registration Using Native Supplicants, on page 490](#)
- [Device Portals Configuration Tasks, on page 492](#)
- [Manage Personal Devices Added by Employees, on page 505](#)
- [Monitor My Devices Portals and Endpoints Activity, on page 506](#)

Personal Devices on a Corporate Network (BYOD)

When supporting personal devices on a corporate network, you must protect network services and enterprise data by authenticating and authorizing users (employees, contractors, and guests) and their devices. Cisco ISE provides the tools you need to allow employees to securely use personal devices on a corporate network.

Guests can automatically register their devices when logging in to the Guest portals. Guests can register additional devices up to the maximum limit that you define in their guest type. These devices are registered into endpoint identity groups based on the portal configuration.

Guests can add their personal devices to the network by running the native supplicant provisioning (Network Setup Assistant), or by adding their devices to the My Devices portal. You can create native supplicant profiles, which determine the proper native supplicant provisioning wizard to use, based on the operating system.

Because native supplicant profiles are not available for all devices, users can use the My Devices portal to add these devices manually; or you can configure BYOD rules to register these devices.

[Cisco ISE Community Resource](#)

End-User Device Portals in a Distributed Environment

Cisco ISE end-user web portals depend on the Administration, Policy Services, and Monitoring personas to provide configuration, session support, and reporting.

- **Policy Administration node (PAN):** Configuration changes that you make to the users, devices, and end-user portals are written to the PAN.
- **Policy Service node (PSN):** The end-user portals run on a PSN, which handles all session traffic, including: network access, client provisioning, guest services, posture, and profiling. If a PSN is part of a node group, and one node fails, the other nodes detect the failure and reset any pending sessions.

- **Monitoring node (MnT node):** The MnT node collects, aggregates, and reports data about the end-user and device activity on the My Devices, Sponsor, and Guest portals. If the primary MnT node fails, the secondary MnT node automatically becomes the primary MnT node.

Global Settings for Device Portals

Choose **Work Centers > BYOD > Settings > Employee Registered Devices** or **Administration > Device Portal Management > Settings**.

You can configure the following general settings for the BYOD and My Devices portals:

- **Employee Registered Devices:** Enter the maximum number of devices that an employee can register in **Restrict employees to**. By default, this value is set to **5** devices.
- **Retry URL:** Enter a URL that can be used to redirect the device back to Cisco ISE in **Retry URL for onboarding**.

Once you configure these general settings, they apply to all BYOD and My Devices portals that you set up for your company.

Related Topics

- [Limit the Number of Personal Devices Registered by Employees](#), on page 490
- [Provide a URL to Reconnect with BYOD Registration](#), on page 491
- [End-User Device Portals in a Distributed Environment](#), on page 483

Personal Device Portals

Cisco ISE provides several web-based portals to support employee-owned personal devices. These device portals do not participate in the guest or sponsor portal flows.

- **Blacklist Portal:** Provides information about personal devices that are block listed and cannot be used to gain access to the network.
- **BYOD Portals:** Enables employees to register their personal devices using native supplicant provisioning functionality.
- **Certificate Provisioning Portal:** Enables administrators and employees to request for user or device certificate(s) for devices that cannot go through the BYOD flow.
- **Client Provisioning Portals:** Forces employees to download a posture agent on their devices that checks for compliance.
- **MDM Portals:** Enables employees to enroll their mobile devices with an external Mobile Device Management (MDM) system.
- **My Devices Portals:** Enables employees to add and register personal devices, including those that do not support native supplicant provisioning, and then manage them.

Cisco ISE provides you with the ability to host multiple device portals on the Cisco ISE server, including a predefined set of default portals. The default portal themes have standard Cisco branding that you can customize through the Administrators portal (**Administration > Device Portal Management**). You can also choose to

further customize a portal by uploading images, logos, and cascading style sheets (CSS) files that are specific to your organization.

Access Device Portals

You can access any of the Personal Device Portals from the Cisco ISE GUI as follows:

-
- Step 1** Choose **Administration > Device Portal Management**.
 - Step 2** Select the specific device portal that you want to configure.
-

Blacklist Portal

Employees do not access this portal directly, but are redirected to it.

If employees lose their personal device or it is stolen, they can update its status in the My Devices portal, which adds it to the Blacklist endpoint identity group. This prevents others from using the device to obtain unauthorized network access. If anyone attempts to connect to the network using one of these devices, they are redirected to the Blacklist portal which informs them that the device is denied access to the network. If the device is found, employees can reinstate it (in the My Devices portal) and regain network access without having to register the device again. Depending on whether the device was lost or stolen, additional provisioning may be required before the device can be connected to the network.

You can configure the port settings (default is port 8444) for the Blacklist portal. If you change the port number, make sure it is not being used by another end-user portal.

For information about configuring a Blacklist portal, see [Edit the Blacklist Portal, on page 495](#).

Certificate Provisioning Portal

Employees can access the Certificate Provisioning portal directly.

The Certificate Provisioning portal allows employees to request certificates for devices that cannot go through the onboarding flow. For example, devices such as point-of-sale terminals cannot go through the BYOD flow and need to be issued certificates manually. The Certificate Provisioning portal allows a privileged set of users to upload a certificate request for such devices, generate key pairs (if required), and download the certificate.

Employees can access this portal and request for a single certificate or make a bulk certificate request using a CSV file.

ISE Community Resource

For information about the functionality and configuration of Cisco ISE Certificate Provisioning Portal, see [ISE 2.0: Certificate Provisioning Portal](#).

Bring Your Own Device Portal

Employees do not access this portal directly.

Employees are redirected to the Bring Your Own Device (BYOD) portal when registering personal devices using native supplicants. The first time employees attempt to access the network using a personal device, they

may be prompted to manually download and launch the Network Setup Assistant (NSA) wizard and be guided through registering and installing the native supplicant. After they have registered a device, they can use the My Devices portal to manage it.



-
- Note**
- BYOD flow is not supported when a device is connected to a network using AnyConnect Network Access Manager (NAM).
 - If you are using the BYOD flow for Android devices, upgrade to Android 11 or enable the Broadcast SSID option in WLAN configuration.
-



-
- Note**
- If you're using Microsoft Edge 93 or Microsoft Edge 94 as your web browser for downloading NSA and AnyConnect wizards, copy-paste the **redirected URL** or **download link** in a new tab and click **Enter** on your keyboard.
- Alternatively, you can click on **Download icon** > **right click on downloaded file** > **Keep file** on your Microsoft Edge 93 or Microsoft Edge 94 browser.
- If you are using Google Chrome 93 or Google Chrome 95 as your web browser for downloading Network Setup Assistant (NSA) and AnyConnect wizards, click the **Keep** option in the download notification to keep and install the NSA and AnyConnect packages on your system.
-

Related Topics

[Create a BYOD Portal](#), on page 497

[Personal Devices on a Corporate Network \(BYOD\)](#), on page 483

Client Provisioning Portal

Employees do not access this portal directly, but are redirected to it.

The Client Provisioning system provides posture assessments and remediations for devices that are attempting to gain access to your corporate network. When employees request network access using their devices, you can route them to a Client Provisioning portal and require them to first download the posture agent. The posture agent scans the device for compliance, such as verifying that virus protection software is installed on it and that its operating system is supported.

Related Topics

[Create a Client Provisioning Portal](#), on page 500

Mobile Device Management Portal

Employees do not access this portal directly, but are redirected to it.

Many companies use a Mobile Device Management (MDM) system to manage employees' mobile devices.

Cisco ISE allows integration with external MDM systems that employees can use to enroll their mobile device and gain access to your corporate network. Cisco provides an external MDM interface that employees can enroll in to register their devices and then connect to the network.

The MDM portal enables employees to enroll in an external MDM system.

Employees can then use the My Devices portal to manage their mobile devices, such as lock their devices with a pin code, reset their device to its default factory settings, or remove applications and settings that were installed when registering the device.

Cisco ISE allows you to have a single MDM portal for all external MDM systems, or a portal for each individual MDM system.

For information about configuring MDM servers to work with Cisco ISE, see [Create an MDM Portal, on page 501](#).

My Devices Portal

Employees can access the My Devices portal directly.

Some network devices that need network access are not supported by native supplicant provisioning and cannot be registered using the BYOD portal. However, employees can add and register personal devices, whose operating systems are not supported or do not have web browsers (such as printers, internet radios, and other devices), using the My Devices portal.

Employees can add and manage new devices by entering the MAC address for the device. When employees add devices using the My Devices portal, Cisco ISE adds the devices to the Endpoints window (**Administration > Context Visibility > Endpoints**) as members of the **RegisteredDevices** endpoint identity group (unless already statically assigned to a different endpoint identity group). The devices are profiled like any other endpoint in Cisco ISE and go through a registration process for network access.

When two MAC addresses from one device are entered into the My Devices portal by a user, profiling determines that they have the same hostname, and they are merged together as a single entry in Cisco ISE. For example, a user registers a laptop with wired and wireless addresses. Any operations on that device, such as delete, acts on both addresses.

When a registered device is deleted from the portal, the **DeviceRegistrationStatus** and **BYODRegistration** attributes change to **Not Registered** and **No**, respectively. However, these attributes remain unchanged when a guest (who is not an employee) registers a device using the Guest Device Registration window in the credentialed Guest portals, because these BYOD attributes are used only during employee device registration.

Regardless of whether employees register their devices using the BYOD or the My Devices portals, they can use the My Devices portal to manage them.



Note The My Devices portal is not available when the Administrator's portal is down.

Related Topics

[Create a My Devices Portal, on page 503](#)

BYOD Deployment Options and Status Flow

The BYOD deployment flows that support personal devices vary slightly based on these factors:

- Single or dual SSID: With single SSID, the same Wireless Local Area Network (WLAN) is used for certificate enrollment, provisioning, and network access. In a dual SSID deployment, there are two SSIDs. One provides enrollment and provisioning, and the other provides secure network access.

- Windows, macOS, iOS, or Android device: The native supplicant flow starts similarly, regardless of the device type, by redirecting employees using a supported personal device to the BYOD portal to confirm their device information. The process diverges based on the device type.

Employee Connects to Network

1. Cisco ISE authenticates the employee's credentials against the corporate Active Directory or other corporate identity stores and provides an authorization policy.
2. The device is redirected to the BYOD portal. The device's MAC address field is preconfigured, and the user can add a device name and description.
3. The native supplicant is configured (MacOS, Windows, iOS, Android) but the process varies by device:
 - MacOS and Windows devices: Employee clicks **Register** in the BYOD portal to download and install the supplicant provisioning wizard (Network Setup Assistant), which configures the supplicant and provides the certificate (if necessary) used for EAP-TLS certificate-based authentication. The issued certificate is embedded with the device's MAC address and employee's username.



Note Network Setup Assistant cannot be downloaded to a Windows device, unless the user of that device has administrative privileges. If you cannot grant end users administrative privileges, then use your Group Policy object (GPO) to push the certificate to the user's device, instead of using the BYOD flow.



Note Starting with version MacOS 10.15, the user must allow download of the Supplicant Provisioning Wizard (SPW). A window displays on the user's device asking them to allow or deny downloads from the Cisco ISE server.

- iOS devices: The Cisco ISE policy server sends a new profile using Apple's iOS over the air to the IOS device, which includes:
 - The issued certificate (if configured) is embedded with the IOS device's MAC address and employee's username.
 - A Wi-Fi supplicant profile that enforces the use of EAP-TLS for 802.1X authentication.
 - Android devices: Cisco ISE prompts and routes employee to download the Network Setup Assistant (NSA) from the Google Play store. After installing the application, the employee can open NSA and start the setup wizard, which generates the supplicant configuration and issued certificate used to configure the device.
4. After the user goes through the on boarding flow, Cisco ISE initiates a Change of Authorization (CoA). This causes the MacOS, Windows, and Android devices to reconnect to the secure 802.1X network. For single SSID, iOS devices also connect automatically, but for dual SSID, the wizard prompts iOS users to manually connect to the new network.



Note You can configure a BYOD flow that does not use supplicants. See the Cisco ISE Community document <https://supportforums.cisco.com/blog/12705471/ise-byod-registration-only-without-native-supPLICANT-or-certificate-provisioning>.



Note Check the **Enable if Target Network is Hidden** check box only when the actual Wi-Fi network is hidden. Otherwise, Wi-Fi network configuration may not be provisioned properly for certain iOS devices, especially in the single SSID flow (where the same Wi-Fi network or SSID is used for both onboarding and connectivity).



Note Mac randomization is not enabled for this flow.

As Android 10 generates random MAC address whenever a new connection profile is created, you must modify the default rule to remove *BYOD_is_Registered* and *MAC_in_SAN* conditions from the authorization profile for the BYOD flow to work with Android clients.

BYOD Session Endpoint Attribute

The state of the endpoint attribute *BYODRegistration* changes during the BYOD flow to the following states.

- *Unknown*: The device has not been through a BYOD flow.
- *Yes*: The device has been through BYOD flow, and is registered.
- *No*: The device has been through BYOD flow, but is not registered. This means that the device was deleted.

Device Registration Status Endpoint Attribute

The state of the endpoint attribute *DeviceRegistrationStatus* changes during device registration to the following states.

- *Registered*: The device has been through BYOD flow, and it is registered. There is a 20-minute delay before the attribute changes from pending to registered.
- *Pending*: The device has been through BYOD flow, and it is registered. But, Cisco ISE has not seen it on the network.
- *Not Registered*: The device has not been through BYOD flow. *Not Registered* is the default state of the *DeviceRegistrationStatus* attribute.
- *Stolen*: The user logs onto the My Devices portal, and marks a currently onboarded device as Stolen. This happens:
 - If the device was onboarded by provisioning a certificate and a profile, Cisco ISE revokes the certificate that was provisioned to the device, and assigns the device's MAC address to the Blacklist endpoint identity group. That device no longer has network access.
 - If the device was onboarded by provisioning a profile (no certificate), Cisco ISE assigns the device to the Blacklist endpoint identity group. The device still has network access, unless you create an

authorization policy for this situation. For example, **IF Endpoint Identity Group is Blacklist AND BYOD_is_Registered THEN DenyAccess**.

An administrator performs an action that disables network access for several devices, such as deleting or revoking a certificate.

If a user reinstates a stolen device, the status reverts to *Not Registered*. The user must delete that device, and add it back. This starts the onboarding process.

- *Lost*: The user logs on to the My Devices portal, and marks a currently onboarded device as *Lost* that causes the following actions:
 - The device is assigned to Blacklist identity group.
 - Certificates provisioned to the device are not revoked.
 - The device status is updated to *Lost*.
 - *BYODRegistration* status is updated to *No*.

A lost device still has network access unless you create an authorization policy to block lost devices. You can use the Blacklist identity group or the *endpoint:BYODRegistration* attribute in your rule. For example, **IF Endpoint Identity Group is Blacklist AND EndPoints:BYODRegistrations Equals No THEN BYOD**. For more granular access, you can also add *NetworkAccess:EAPAuthenticationMethod Equals PEAP or EAP-TLS or EAP-FAST* , *InternalUser:IdentityGroup Equals <<group>>* to the IF part of the rule.

Limit the Number of Personal Devices Registered by Employees

You can allow employees to register between 1 and 999 personal devices. Regardless of the portal that employees used to register their personal devices, this setting defines the maximum number of devices registered across all portals.

-
- Step 1** Choose **Administration > Device Portal Management > Settings > Employee Registered Devices**.
 - Step 2** Enter the maximum number of devices that an employee can register in the **Restrict employees to** field. By default, this value is set to **5** devices.
 - Step 3** Click **Save**. If you do not want to save any updates you made to the settings, click **Reset** to revert to the last saved values.
-

Support Device Registration Using Native Supplicants

You can create native supplicant profiles to support personal devices on the Cisco ISE network. Based on the profile that you associate with a user's authorization requirements, Cisco ISE provides the necessary supplicant provisioning wizard to set up the user's personal device to access the network.

The first time employees attempt to access the network using a personal device, they are guided automatically through the registration and supplicant configuration. After they have registered the device, they can use the My Devices portal to manage their devices.

Operating Systems Supported by Native Supplicants

Native supplicants are supported for these operating systems:

- Android (excluding Amazon Kindle, B&N Nook)
- MacOS (for Apple Mac computers)
- Apple iOS devices (Apple iPod, iPhone, and iPad)
- Microsoft Windows 7, 8 (excluding RT), Vista, and 10

Allow Employees to Register Personal Devices Using Credentialed Guest Portals

Employees using credentialed Guest portals can register their personal devices. The self-provisioning flow supplied by the BYOD portal enables employees to connect devices to the network directly using native supplicants, which are available for Windows, MacOS, iOS, and Android devices.

Before you begin

You must create the native supplicant profiles.

-
- Step 1** Choose **Work Centers > Guest Access > Portals & Components > Guest Portals**.
 - Step 2** Choose the credentialed Guest portal that you want to allow employees to use to register their devices using native supplicants and click **Edit**.
 - Step 3** Click the **Portal Behavior and Flow Settings** tab.
 - Step 4** Under **BYOD Settings**, check the **Allow employees to use personal devices on the network** check box.
 - Step 5** Click **Save**.
-

Provide a URL to Reconnect with BYOD Registration

You can provide information that enables employees, who encounter a problem while registering their personal devices using the BYOD portal to reconnect with the registration process.

-
- Step 1** Choose **Administration > Device Portal Management > Settings > Retry URL**.
 - Step 2** In the **Retry URL for Onboarding** field, enter the URL to be used to redirect the device back to Cisco ISE. When a device encounters a problem during the registration process, it tries to reconnect to the internet automatically. At this point, the URL that you enter here is used to redirect the device back to Cisco ISE (which reinitiates the onboarding process). The default value is 1.1.1.1.
 - Step 3** Click **Save**.
If you do not want to save any updates you made to the settings, click **Reset** to revert to the last saved values.
-

Device Portals Configuration Tasks

You can use a default portal and its default settings such as certificates, endpoint identity group, identity source sequence, portal themes, images, and other details provided by Cisco ISE. If you do not want to use the default settings, you should create a new portal or edit an existing one to meet your needs. You can duplicate a portal if you want to create multiple portals with the same settings.

After creating a new portal or editing a default one, you must authorize the portal for use. Once you authorize a portal for use, any subsequent configuration changes you make are effective immediately.

You do not need to authorize the My Devices portal for use.

If you choose to delete a portal, you must first delete any authorization policy rules and authorization profiles associated with it or modify them to use another portal.

Use this table for the tasks related to configuring the different Device portals.

Task	Blacklist Portal	BYOD Portal	Client Provisioning Portal	MDM Portal	My Devices Portal
Enable Policy Services, on page 493	Required	Required	Required	Required	Required
Add Certificates to the Device Portal, on page 493	Required	Required	Required	Required	Required
Create External Identity Sources, on page 494	Not Required	Not Required	Not Required	Not Required	Required
Create Identity Source Sequences, on page 494	Not Required	Not Required	Not Required	Not Required	Required
Create Endpoint Identity Groups, on page 495	Not Required	Required	Not Required	Required	Required
Edit the Blacklist Portal	Required	Not applicable	Not applicable	Not applicable	Not applicable
Create a BYOD Portal, on page 497	Not applicable	Required	Not applicable	Not applicable	Not applicable
Create a Client Provisioning Portal, on page 500	Not applicable	Not applicable	Required	Not applicable	Not applicable
Create an MDM Portal, on page 501	Not applicable	Not applicable	Not applicable	Required	Not applicable

Task	Blacklist Portal	BYOD Portal	Client Provisioning Portal	MDM Portal	My Devices Portal
Create a My Devices Portal, on page 503	Not applicable	Not applicable	Not applicable	Not applicable	Required
Create Authorization Profiles, on page 504	Not applicable	Required	Required	Required	Not Required
Customize Device Portals, on page 505	Optional	Optional	Optional	Optional	Optional

Enable Policy Services

To support the Cisco ISE end-user web portals, you must enable the portal-policy services on the node on which you want to host them.

-
- Step 1** Choose **Administration > System > Deployment**.
 - Step 2** Click the node and click **Edit**.
 - Step 3** Under the **General Settings** tab, check the **Policy Service** check box.
 - Step 4** Check the **Enable Session Services** check box.
 - Step 5** Click **Save**.
-

Add Certificates to the Device Portal

If you do not want to use the default certificates, you can add a valid certificate and assign it to a certificate group tag. The default certificate group tag used for all end-user web portals is **Default Portal Certificate Group**.

-
- Step 1** Choose **Administration > System > Certificates > System Certificates**.
 - Step 2** Add a system certificate and assign it to a certificate group tag that you want to use for the portal.
This certificate group tag will be available to select during portal creation or editing.
 - Step 3** Choose **Administration > Device Portal Management > (any portal) > Create or Edit > Portal Settings**.
 - Step 4** Select the specific certificate group tag from the **Certificate Group Tag** drop-down list that is associated with the newly added certificate.
-



-
- Note**
- BYOD does not support certificate chains longer than three certificates.
 - During BYOD onboarding, certificates are issued twice for iOS devices.
-

Create External Identity Sources

Cisco ISE can connect with external identity sources such as Active Directory, LDAP, RADIUS Token, and RSA SecurID servers to obtain user information for authentication and authorization. External identity sources also include certificate authentication profiles that you need for certificate-based authentications.



-
- Note** To work with passive identity services, which enable you to receive and share authenticated user identities, see [Additional Passive Identity Service Providers, on page 369](#).
-

Step 1 Choose **Administration > Identity Management > External Identity Sources**.

Step 2 Choose one of these options:

- **Certificate Authentication Profile** for certificate-based authentications.
 - **Active Directory** to connect to an Active Directory as an external identity source. See [Active Directory as an External Identity Source, on page 323](#) for more details.
 - **LDAP** to add an LDAP identity source. See [LDAP, on page 409](#) for more details.
 - **RADIUS Token** to add a RADIUS Token server. See [RADIUS Token Identity Sources, on page 423](#) for more details.
 - **RSA SecurID** to add an RSA SecurID server. See [RSA Identity Sources, on page 428](#) for more details.
 - **SAML Id Providers** to add an identity provider (IdP), such as Oracle Access Manager. See [SAMLv2 Identity Provider as an External Identity Source, on page 432](#) for more details.
-

Create Identity Source Sequences

Before you begin

Ensure that you have configured your external identity sources in Cisco ISE.

To perform the following task, you must be a Super Admin or System Admin.

For allowing guest users to authenticate through Local WebAuth, you must configure both the Guest portal authentication source and the identity source sequence to contain the same identity stores.

Step 1 Choose **Administration > Identity Management > Identity Source Sequences > Add**.

Step 2 Enter a name for the identity source sequence. You can also enter an optional description.

Step 3 Check the **Select Certificate Authentication Profile** check box and choose a certificate authentication profile for certificate-based authentication.

- Step 4** Choose the database or databases that you want to include in the identity source sequence in the **Selected List** field.
- Step 5** Rearrange the databases in the **Selected list** field in the order in which you want Cisco ISE to search the databases.
- Step 6** Choose one of the following options in the **Advanced Search List** area:
- **Do not access other stores in the sequence and set the AuthenticationStatus attribute to ProcessError:** Choose this option if you want Cisco ISE to discontinue the search, if the user is not found in the first selected identity source.
 - **Treat as if the user was not found and proceed to the next store in the sequence:** Choose this option if you want Cisco ISE to continue searching the other selected identity sources in sequence, if the user is not found in the first selected identity source.
- While processing a request, Cisco ISE searches these identity sources in sequence. Ensure that you have the identity sources in the Selected list field listed in the order in which you want Cisco ISE to search them.
- Step 7** Click **Submit** to create the identity source sequence that you can then use in policies.
-

Create Endpoint Identity Groups

Cisco ISE groups endpoints that it discovers in to the corresponding endpoint identity groups. Cisco ISE comes with several system-defined endpoint identity groups. You can also create additional endpoint identity groups from the **Endpoint Identity Groups** window. You can edit or delete the endpoint identity groups that you have created. You can only edit the description of the system-defined endpoint identity groups. You cannot edit the name of these groups or delete them.

- Step 1** Choose **Administration > Identity Management > Groups > Endpoint Identity Groups**.
- Step 2** Click **Add**.
- Step 3** Enter the **Name** for the endpoint identity group that you want to create (do not include spaces in the name of the endpoint identity group).
- Step 4** Enter the **Description** for the endpoint identity group that you want to create.
- Step 5** Click the **Parent Group** drop-down list to choose an endpoint identity group to which you want to associate the newly created endpoint identity group.
- Step 6** Click **Submit**.
-

Edit the Blacklist Portal

Cisco ISE provides a single Blacklist portal that displays information when a lost or stolen device that is block listed in Cisco ISE is attempting to access your corporate network.

You can only edit the default portal settings and customize the default message that displays for the portal. You cannot create a new Blacklist portal, or duplicate or delete the default portal.

Before you begin

Ensure that you have the required certificates configured for use with this portal.

- Step 1** Choose **Administration > Device Portal Management > Blacklist Portal > Edit**.
- Step 2** Provide a unique **Portal Name** and a **Description** for the portal.
Ensure that the portal name that you use here is not used for any other end-user portals.
- Step 3** From the **Language File** drop-down list, choose the desired action to import or export language files to be used with the portal.
- Step 4** Click the **Portal test URL** link to open a new browser tab that displays the URL for this portal. Policy Services Node (PSN) with Policy Services must be turned on. If Policy Services are disabled, the PSN only displays the Admin portal.
- Note** The test portal does not support RADIUS sessions, so you won't see the entire portal flow for all portals. BYOD and Client Provisioning are examples of portals that depend on RADIUS sessions. For example, a redirect to an external URL will not work. If you have more than one PSN, Cisco ISE chooses the first active PSN.
- Step 5** Expand **Portal Settings**. Update the default values for ports, certificate group tags, endpoint identity groups, and so on, and define behavior that applies to the overall portal.

- **HTTPS Port:** Enter a port value between 8000 to 8999; the default value is 8443 for all the default portals, except the Blacklist Portal, which is 8444. If you upgraded with port values outside this range, they are honored until you modify this window. If you modify this window, update the port setting to comply with this restriction.

If you assign ports used by a non-guest (such as My Devices) portal to a guest portal, an error message appears.

For posture assessments and remediation only, the Client Provisioning portal also uses ports 8905 and 8909. Otherwise, it uses the same ports assigned to the Guest portal.

Portals assigned to the same HTTPS port can use the same Gigabit Ethernet interface or another interface. If they use the same port and interface combination, they must use the same certificate group tag. For example:

- Valid combinations include, using the Sponsor portal as an example:
 - Sponsor portal: Port **8443**, Interface **0**, Certificate tag **A** and My Devices portal: Port **8443**, Interface **0**, Certificate group **A**.
 - Sponsor portal: Port **8443**, Interface **0**, Certificate group **A** and My Devices portal: Port **8445**, Interface **0**, Certificate group **B**.
 - Sponsor portal: Port **8444**, Interface **1**, Certificate group **A** and Blacklist portal: Port **8444**, Interface **0**, Certificate group **B**.
- Invalid combinations include:
 - Sponsor portal: Port **8443**, Interface **0**, Certificate group **A** and My Devices portal: **8443**, Interface **0**, Certificate group **B**.
 - Sponsor portal: Port **8444**, Interface **0**, Certificate tag **A** and Blacklist portal: Port **8444**, Interface **0**, Certificate group **A**.

Note We recommend that you use interface 0 for Guest services for best performance. You can either configure only interface 0 in the **Portal Settings**, or you can use the CLI command **ip host** to map a hostname or FQDN to the IP address of interface 0.

- **Allowed Interfaces:** Select the PSN interfaces which a PAN can use to run a portal. When a request to open a portal is made on the PAN, the PAN looks for an available allowed port on the PSN. You must configure the Ethernet interfaces using IP addresses on different subnets.

These interfaces must be available on all the PSNs, including VM-based ones, that have Policy Services turned on. This is a requirement because any of these PSNs can be used for the redirect at the start of the guest session.

- The Ethernet interfaces must use IP addresses on different subnets.
- The interfaces you enable here must be available on all your PSNs, including VM-based ones when Policy Services turned on. This is required because any of these PSNs can be used for a redirect at the start of the guest session.
- The portal certificate Subject Name or Alternate Subject Name must resolve to the interface IP address.
- Configure **ip host x.x.x.x yyy.domain.com** in Cisco ISE CLI to map the secondary interface IP address to the FQDN, which is used to match the certificate Subject Name or Alternate Subject Name.
- If only the bonded NIC is selected, when the PSN attempts to configure the portal it first attempts to configure the Bond interface. If that is not successful, perhaps because there was no bond setup on that PSN, then the PSN logs an error and exits. The PSN will not try to start the portal on the physical interface.
- NIC Teaming or bonding is a configuration option that allows you to configure two individual NICs for high availability (fault tolerance). If one of the NICs fails, the other NIC that is part of the bonded connection continues the connection. A NIC is selected for a portal based in the **Portal Settings** configuration. If both physical NICs and the corresponding bonded NIC are configured, when the PSN attempts to configure the portal, it first attempts to connect to the Bond interface. If that is not successful, perhaps because there was no bond setup on that PSN, then the PSN attempts to start the portal on the physical interface.
- **Certificate Group tag:** Pick a certificate group tag that specifies the certificate to be used for the portal's HTTPS traffic.
- **Display Language**
 - **Use Browser Locale:** Use the language specified in the client browser's locale setting as the display language of the portal. If browser locale's language is not supported by Cisco ISE, then the **Fallback Language** is used as the language portal.
 - **Fallback Language:** Choose the language to use when the language cannot be obtained from the browser locale, or if the browser locale language is not supported by Cisco ISE.
 - **Always Use:** Choose the display language to use for the portal. This setting overrides the **User Browser Locale** option.

Step 6 On the **Portal Page Customization** tab, customize the page title and message text that appears in the portal when an unauthorized device is attempting to gain access to the network.

Step 7 Click **Save** and then **Close**.

Create a BYOD Portal

You can provide a Bring Your Own Device (BYOD) portal to enable employees to register their personal devices, so that the registration and supplicant configuration can be done before allowing access to the network.

You can create a new BYOD portal, or you can edit or duplicate an existing one. You can delete any BYOD portal, including the default portal provided by Cisco ISE.

Any changes that you make to the **Portal & Page Settings** under the **Portal Behavior and Flow Settings** tab are reflected in the graphical flow in the device portal flow diagram. If you enable a window, such as the **Support Information** window, the window appears in the flow and the employee experiences it in the portal. Disabling the window removes it from the flow.

Before you begin

Ensure that you have the required certificates and endpoint identity groups configured for use within this portal.

-
- Step 1** Choose **Administration > Device Portal Management > BYOD > Create**.
- Step 2** Provide a unique **Portal Name** and a **Description** for the portal.
Ensure that the portal name you use here is not used for any other end-user portals.
- Step 3** From the **Language File** drop-down list, choose the desired action to import or export language files to be used with the portal.
- Step 4** Click the **Portal Behavior and Flow Settings** tab.
- Step 5** Expand **Portal Settings**. Update the default values for ports, certificate group tags, endpoint identity groups, and so on, and define behavior that applies to the overall portal.
- Step 6** Expand **Support Information Page Settings**. Update the required information here to help employees provide information that the Help Desk can use to troubleshoot network access issues.
- Step 7** Click the **Portal Page Customization** tab. Scroll down to the **Page Customizations** area to customize the following end user portal windows. Choose the portal window you want to customize by clicking the corresponding option listed under **Pages** in the left side menu.
- **BYOD Welcome:**
 - **Device Configuration Required:** Enter the content to be displayed when the device is redirected to the BYOD portal for the first time and requires certificate provisioning.
 - **Certificate Needs Renewal:** Enter the content to be displayed when the previous certificate needs to be renewed.
 - **BYOD Device Information:**
 - **Maximum Devices Reached:** Enter the content to be displayed when the maximum limit of devices that an employee can register is reached.
 - **Required Device Information:** Enter the content to be displayed when requesting device information that is required to enable an employee to register the device.
 - **BYOD Installation:**
 - **Desktop Installation:** Enter the content to be displayed when providing installation information for a desktop device.
 - **iOS Installation:** Enter the content to be displayed when providing installation instructions for an iOS mobile device.
 - **Android Installation:** Enter the content to be displayed when providing installation instructions for an Android mobile device.
 - **BYOD Success:**

- **Success:** Enter the content to be displayed when the device is configured and automatically connected to the network.
- **Success: Manual Instructions:** Enter the content to be displayed when the device is successfully configured and an employee must manually connect to the network.
- **Success: Unsupported Device:** Enter the content to be displayed when an unsupported device is allowed to connect to the network.

Step 8 Click **Save** and then click **Close**.

What to do next

You must authorize the portal in order to use it. You can also customize your portal either before or after you authorize it for use.

Create a Certificate Provisioning Portal

Cisco ISE provides a Certificate Provisioning portal that allows you to request for certificates for devices that cannot go through the onboarding flow. For example, devices such as point-of-sale terminals. You can request for a single certificate or make a bulk certificate request using a CSV file.

You can edit the default portal settings and customize the messages that appear on the portal. You can also create, duplicate, and delete the Certificate Provisioning portal.

There are two types of users who can access the Certificate Provisioning portal:

- Internal or external users with administrative privileges: Can generate certificates for themselves as well as for others.
- All other users: Can generate certificates only for themselves.

Users (network access users) who are assigned the Super Admin or ERS Admin role have access to this portal and can request certificates for others. However, if you create a new internal admin user and assign the Super Admin or ERS Admin role, the internal admin user will not have access to this portal. You must first create a network access user and then add the user to the Super Admin or ERS Admin group. Any existing network access users who are added to the Super Admin or ERS Admin group will have access to this portal.

For other users to be able to access the portal and to generate certificates for themselves, configure the Certificate Provisioning Portal Settings. The navigation path for this window is **Administration > Device Portal Management > Certificate Provisioning > Edit > Portal Behavior and Flow Settings > Portal Settings**. Ensure that you choose the appropriate identity source or identity source sequence under **Authentication Method** and choose the user group under **Configure Authorized Groups**. All users who belong to the groups that you choose will have access to the portal and can generate certificates for themselves.

Before you begin

Ensure that you have the required certificates configured for use with this portal.

Step 1 Choose **Administration > Device Portal Management > Certificate Provisioning > Create**.

Ensure that the portal name that you use here is not used for any other end-user portals.

- Step 2** Provide a unique **Portal Name** and a **Description** for the portal.
- Step 3** From the **Language File** drop-down list, choose the desired action to import or export language files to be used with the portal.
- Step 4** Click the **Portal Behavior and Flow Settings** tab.
- Step 5** Expand **Portal Settings**. Update the default values for ports, certificate group tags, endpoint identity groups, and so on, and define behavior that applies to the overall portal.
- Step 6** Click the **Portal Page Customization** tab. Customize the page title and the message text that appears in the portal.
- Step 7** Click **Save** and then **Close**.

Create a Client Provisioning Portal

You can provide a Client Provisioning portal to enable employees to download the Cisco AnyConnect posture component or the Cisco NAC agent, that verifies the posture compliance of the device before allowing access to the network.

You can create a new Client Provisioning portal, or you can edit or duplicate an existing one. You can delete any Client Provisioning portal, including the default portal provided by Cisco ISE.

Users (network access users) who are assigned the Super Admin or ERS Admin role have access to this portal. However, if you create a new internal admin user and assign the Super Admin or ERS Admin role, the internal admin user will not have access to this portal. You must first create a network access user and then add the user to the Super Admin or ERS Admin group. Any existing network access users who are added to the Super Admin or ERS Admin group will have access to this portal.

For other users to be able to access the portal and to generate certificates for themselves, configure the Certificate Provisioning Portal settings. The navigation path for this window is **Administration > Device Portal Management > Client Provisioning > Edit > Portal Behavior and Flow Settings > Portal Settings**. Ensure that you choose the appropriate identity source or identity source sequence under **Authentication Method** and choose the user group under **Configure Authorized Groups**. All users who belong to the groups that you choose will have access to the portal and can generate certificates for themselves.

Any changes that you make to the **Portal & Page Settings** under the **Portal Behavior and Flow Settings** tab are reflected in the graphical flow in the device portal flow diagram. If you enable a window, such as the **Support Information** window, the window appears in the flow and the employee experiences it in the portal. Disabling the window removes it from the flow.

Before you begin

Ensure that you have the required certificates and client provisioning policies configured for use with this portal.

- Step 1** Choose **Administration > Device Portal Management > Client Provisioning > Create**.
- Step 2** Provide a unique **Portal Name** and a **Description** for the portal.
Ensure that the portal name
- Step 3** From the **Language File** drop-down list, choose the desired action to import or export language files to be used with the portal.
- Step 4** Click the **Portal Behavior and Flow Settings** tab.

- Step 5** Expand **Portal Settings**. Update the default values for ports, certificate group tags, endpoint identity groups, and so on, and define behavior that applies to the overall portal.
- Step 6** Expand **Support Information Page Settings**. Update the required information here to help employees provide information that the Help Desk can use to troubleshoot network access issues.
- Step 7** Click the **Portal Page Customization** tab. Scroll down to the **Page Customizations** area to customize the following end user portal windows. Choose the portal window you want to customize by clicking the corresponding option listed under **Pages** in the left side menu.
- **Client Provisioning Portals:**
 - **Agent Unknown:** Enter the content to be displayed when the agent is unknown.
 - **Checking, Scanning and Compliant:** Enter the content to be displayed when the posture agent is successfully installed and checks, scans and verifies that the device is compliant with posture requirements.
 - **Non-compliant:** Enter the content to be displayed when the posture agent determines that the device is not compliant with posture requirements.
 - **Client Provisioning (Agent Not Found):**
 - **Agent Not Found:** Enter the content to be displayed when the posture agent is not detected on the device.
 - **Manual Installation Instructions:** Enter the content to be displayed when devices do not have Java or Active X software installed on them, instructions on how to manually download and install the posture agent.
 - **Install, No Java/ActiveX:** Enter the content to be displayed when devices do not have Java or Active X software installed on them, instructions on how to download and install the Java plug-in.
 - **Agent Installed:** Enter the content to be displayed when the posture agent is detected on the device, instructions on how to start the posture agent, which checks the device for compliance with posture requirements.
- Step 8** Click **Save** and then click **Close**.
-

What to do next

You must authorize the portal in order to use it. You can also customize your portal either before or after you authorize it for use.

Related Topics

[Authorize Portals](#), on page 461

[Customize Device Portals](#), on page 505

Create an MDM Portal

You can provide a Mobile Device Management (MDM) portal to enable employees to manage their mobile devices that are registered for use on your corporate network.

You can create a new MDM portal, or you can edit or duplicate an existing one. You can have a single MDM portal for all of your MDM systems or you can create a portal for each system. You can delete any MDM portal, including the default portal provided by Cisco ISE. The default portal is for third-party MDM providers.

You can create a new MDM portal, or you can edit or duplicate an existing one. You can delete any MDM portal, including the default portal provided by Cisco ISE. The default portal is for third-party MDM providers.

Any changes that you make to the **Portal & Page Settings** under the **Portal Behavior and Flow Settings** tab are reflected in the graphical flow in the device portal flow diagram. If you enable a window, such as the **Support Information** window, the window appears in the flow and the employee experiences it in the portal. Disabling the window removes it from the flow.

Before you begin

Ensure that you have the required certificates and endpoint identity groups configured for use with this portal.

-
- Step 1** Choose **Administration > Device Portal Management > Mobile Device Management > Create, Edit or Duplicate**.
- Step 2** Provide a unique **Portal Name** and a **Description** for the portal.
Ensure that the portal name you use here is not used for any other end-user portals.
- Step 3** From the **Language File** drop-down list, choose the desired action to import or export language files to be used with the portal.
- Step 4** Click the **Portal Behavior and Flow Settings** tab.
- Step 5** Expand **Portal Settings**. Update the default values for ports, certificate group tags, endpoint identity groups, and so on, and define behavior that applies to the overall portal.
- Step 6** Expand **Employee Mobile Device Management Settings**. Access the link provided to configure third-party MDM providers and then define the acceptance policy behavior for employees using the MDM portals.
- Step 7** Expand **Support Information Page Settings**. Update the required information here to help employees provide information that the help desk can use to troubleshoot network access issues.
- Step 8** Click the **Portal Page Customization** tab.
- Step 9** Customize the **Content Area** messages that appears in the MDM portal during the device enrollment process.
- **Unreachable**: Enter the content to be displayed when the selected MDM system cannot be reached.
 - **Non-compliant**: Enter the content to be displayed when the device being enrolled is not compliant with the requirements of the MDM system.
 - **Continue**: Enter the content to be displayed when the device should try connecting to the network in case of connectivity issues.
 - **Enroll**: Enter the content to be displayed when the device requires the MDM agent and needs to be enrolled in the MDM system.
- Step 10** Click **Save** and then click **Close**.
-

What to do next

You must authorize the portal in order to use it. You can also customize your portal either before or after you authorize it for use. Also see the following topics:

- [Add Certificates to the Device Portal, on page 493](#)
- [Create Endpoint Identity Groups, on page 495](#)
- [Create Authorization Profiles, on page 504](#)
- [Customize Device Portals, on page 505](#)

Create a My Devices Portal

You can provide a My Devices portal to enable employees to add and register their personal devices that do not support native supplicants and cannot be added using the Bring Your Own Device (BYOD) portal. You can then use the My Devices portal to manage all devices that have been added using either portal.

You can create a new My Devices portal, or you can edit or duplicate an existing one. You can delete any My Devices portal, including the default portal provided by Cisco ISE.

Any changes that you make to the **Portal & Page Settings** under the **Portal Behavior and Flow Settings** tab are reflected in the graphical flow in the device portal flow diagram. If you enable a window, such as the **Support Information** window, the window appears in the flow and the employee experiences it in the portal. Disabling the window removes it from the flow.

Before you begin

Ensure that you have the required certificates, external identity stores, identity source sequences, and endpoint identity groups configured for use with this portal.

-
- Step 1** Choose **Administration > Device Portal Management > My Devices > Create**.
- Step 2** Provide a unique **Portal Name** and a **Description** for the portal.
Ensure that the portal name you use here is not used for any other end-user portals.
- Step 3** From the **Language File** drop-down list, choose the desired action to import or export language files to be used with the portal.
- Step 4** Click the **Portal Behavior and Flow Settings** tab.
- Step 5** Expand **Portal Settings** to update the default values for ports, certificate group tags, endpoint identity groups, and so on, and define behavior that applies to the overall portal.
- Step 6** Expand **Login Page Settings** to specify employee credential and login guidelines.
- Step 7** Expand **Acceptable Use Policy (AUP) Page Settings** to add a separate AUP page and define the acceptable use policy behavior for employees.
- Step 8** Expand **Post-Login Banner Page Settings** to notify employees of additional information after they log into the portal.
- Step 9** Expand **Employee Change Password Settings** to allow employees to change their own passwords. This option is enabled only if the employee is part of the internal users database.
- Step 10** In the **Portal Page Customization** tab, customize the following information that appears in the My Devices portal during registration and management:
- Titles, instructions, content, field and button labels
 - **Error messages** and **Notification Messages**
- Step 11** Click **Save** and then click **Close**.
-

What to do next

You can customize the portal if you want to change its appearance.

Related Topics

[Customize Device Portals](#), on page 505

[My Devices Portal](#), on page 487

[Display Devices Added by an Employee](#), on page 505

Create Authorization Profiles

When you authorize a portal, you are setting up the network authorization profiles and rules for network access.

Before you begin

You must create a portal before you can authorize it.

Step 1 Set up a special authorization profile for the portal.

Step 2 Create an authorization policy rule for the profile.

Create Authorization Profiles

Each portal requires that you set up a special authorization profile for it.

Before you begin

If you do not plan to use a default portal, you must first create the portal so you can associate the portal name with the authorization profile.

What to do next

You should create a portal authorization policy rule that uses the newly created authorization profile.

Create Authorization Policy Rules

To configure the redirection URL for a portal to use when responding to the users' (guests, sponsors, employees) access requests, define an authorization policy rule for that portal.

The url-redirect takes the following form based on the portal type, where:

ip:port : the IP address and port number

PortalID: the unique portal name

For a Hotspot Guest portal:

`https://ip:port/guestportal/gateway?sessionID=SessionIdValue&portal=PortalID&action=cwa&type=drw`

For a Mobile Device Management (MDM) portal:

`https://ip:port/mdmportal/gateway?sessionID=SessionIdValue&portal=PortalID&action=mdm`

Step 1 Choose **Policy > Authorization** to create a new authorization policy rule under **Standard** policies.

If you have already enabled Policy Sets, pick the Policy Set you plan to use for this portal, expand the Authorization Policy, and add a new rule.

Step 2 For **Conditions**, select an endpoint identity group that you want to use for the portal validation. For example, for the Hotspot Guest portal, select the default **GuestEndpoints** endpoint identity group and, for the MDM portal, select the default **RegisteredDevices** endpoint identity group.

Note Reauthenticate and Terminate CoA types are supported by Hotspot Guest portals. You can use Network Access:UseCase EQUALS Guest Flow as one of the validation conditions in the Hotspot Guest authorization policy only when Reauthentication CoA type is chosen in the Hotspot Guest Portal.

Step 3 For **Permissions**, select the portal authorization profile that you created.



Note While creating an authorization condition using a dictionary attribute with the MAC option enabled, such as RADIUS.Calling-Station-ID, you must use a Mac operator (for example, Mac_equals) to support different MAC formats.

Customize Device Portals

You can customize the portal appearance and user (guests, sponsors, or employees as applicable) experience by customizing the portal themes, changing UI elements on the portal pages, and editing error messages and notifications that are displayed to the users. For more information about customizing portals, see [Customization of End-User Web Portals](#), on page 509.

Manage Personal Devices Added by Employees

When employees register a device using the Bring Your Own Device (BYOD) or the My Devices portals, the registered device is displayed in the **Endpoints** list. Although employees can disassociate a device from their account by deleting it, the device remains in the Cisco ISE database. As a result, employees might need your assistance in resolving errors they encounter when working with their devices.

Display Devices Added by an Employee

You can locate devices added by a specific employee using the **Portal User** field displayed on the **Endpoints** listing window. This might be useful if you need to delete devices registered by a specific user. By default, this field does not display, so you must enable it first before searching.

Step 1 Choose **Work Centers > Network Access > Identities > Endpoints**.

Step 2 Click the **Settings** icon available on the top right corner of the endpoints list, below the dashlets.

Step 3 Check the **Portal User** check box. Enable the **Portal User** toggle button to display this information in the endpoints listing.

Step 4 Click **Go**.

Step 5 Click the **Filter** drop-down list and choose **Quick Filter**.

Step 6 Enter the user's name in the **Portal User** field to display only the endpoints that are assigned to that particular user.

Errors When Adding Devices to My Devices Portal

Employees cannot add a device that was already added by another employee, and that device is still in the endpoints database.

If employees attempt to add a device that already exists in the Cisco ISE database:

- We recommend adding the device through the BYOD portal, if it supports native supplicant provisioning. This overwrites any registration details that were created when it was initially added to the network.
- If the device is a MAC Authentication Bypass (MAB) device, such as a printer, then first resolve the ownership of the device. If appropriate, you can remove the device from the endpoints database using the Administrator's portal, so that the new owner can successfully add the device using the My Devices portal.



Note The My Devices portal is not available when the Administrator's portal is down.

Devices Deleted from My Devices Portal Remain in Endpoints Database

When an employee deletes a device from the My Devices portal, the device is removed from the employee's list of registered devices, but the device remains in the Cisco ISE endpoints database and is displayed in the **Endpoints** list.

You can permanently delete the device from the Endpoints window. The navigation path for this window is **Work Centers > Network Access > Identities > Endpoints**.

Limit the Number of Personal Devices Registered by Employees

You can allow employees to register between 1 and 999 personal devices. Regardless of the portal that employees used to register their personal devices, this setting defines the maximum number of devices registered across all portals.

-
- Step 1** Choose **Administration > Device Portal Management > Settings > Employee Registered Devices**.
- Step 2** Enter the maximum number of devices that an employee can register in the **Restrict employees to** field. By default, this value is set to **5** devices.
- Step 3** Click **Save**. If you do not want to save any updates you made to the settings, click **Reset** to revert to the last saved values.
-

Monitor My Devices Portals and Endpoints Activity

Cisco ISE provides various reports and logs that allow you to view endpoint and user management information and guest and sponsor activity.

You can run these reports either on demand or on a scheduled basis.

-
- Step 1** Choose **Operations > Reports > Reports**.
- Step 2** Choose **Guest** or **Endpoints and Users** to view the various guest, sponsor, and endpoint related reports
- Step 3** Choose the data with which you want to search using the **Filters** drop-down list.
- Step 4** Select the **Time Range** during which you want to view the data.
- Step 5** Click **Run**.
-

My Devices Login and Audit Report

The **My Devices Login and Audit** report is a combined report that tracks:

- Login activity by employees at the My Devices portal.
- Device related operations performed by the employees in the My Devices portal.

This report is available at: **Operations > Reports > Reports > Guest > My Devices Login and Audit**.

Registered Endpoints Report

The **Registered Endpoints** report provides information about all the endpoints that are registered by employees. This report is available at: **Operations > Reports > Reports > Endpoints and Users > Registered Endpoints**. You can filter on attributes such as **Identity**, **Endpoint ID**, **Identity Group**, **Endpoint Profile** and you can generate a report.

You can query the endpoint database for endpoints that are assigned to the **Registered Devices** endpoint identity group. You can also generate reports for specific users that have the **Portal User** attribute set to a non null value.

The **Registered Endpoints** report provides information about a list of endpoints that are registered through device registration portals by a specific user for a selected period of time.



CHAPTER 18

Customize End-User Web Portals

- [End-User Portals](#) , on page 509
- [Customization of End-User Web Portals](#) , on page 509
- [Portal Content Types](#), on page 512
- [Basic Customization of Portals](#), on page 513
- [Advanced Customization of Portals](#) , on page 521
- [Portal Language Customization](#), on page 538
- [Customization of Guest Notifications, Approvals, and Error Messages](#), on page 541

End-User Portals

Cisco ISE provides web-based portals for three primary sets of end users:

- Guests who need to temporarily access your enterprise network using the Guest portals (Hotspot and credentialed Guest portals).
- Employees who are designated as sponsors who can create and manage guest accounts using the Sponsor portal.
- Employees who are using their personal devices on the enterprise network using the various non-guest portals such as the Bring Your Own Device (BYOD), Mobile Device Management (MDM), and My Devices portals.

Customization of End-User Web Portals

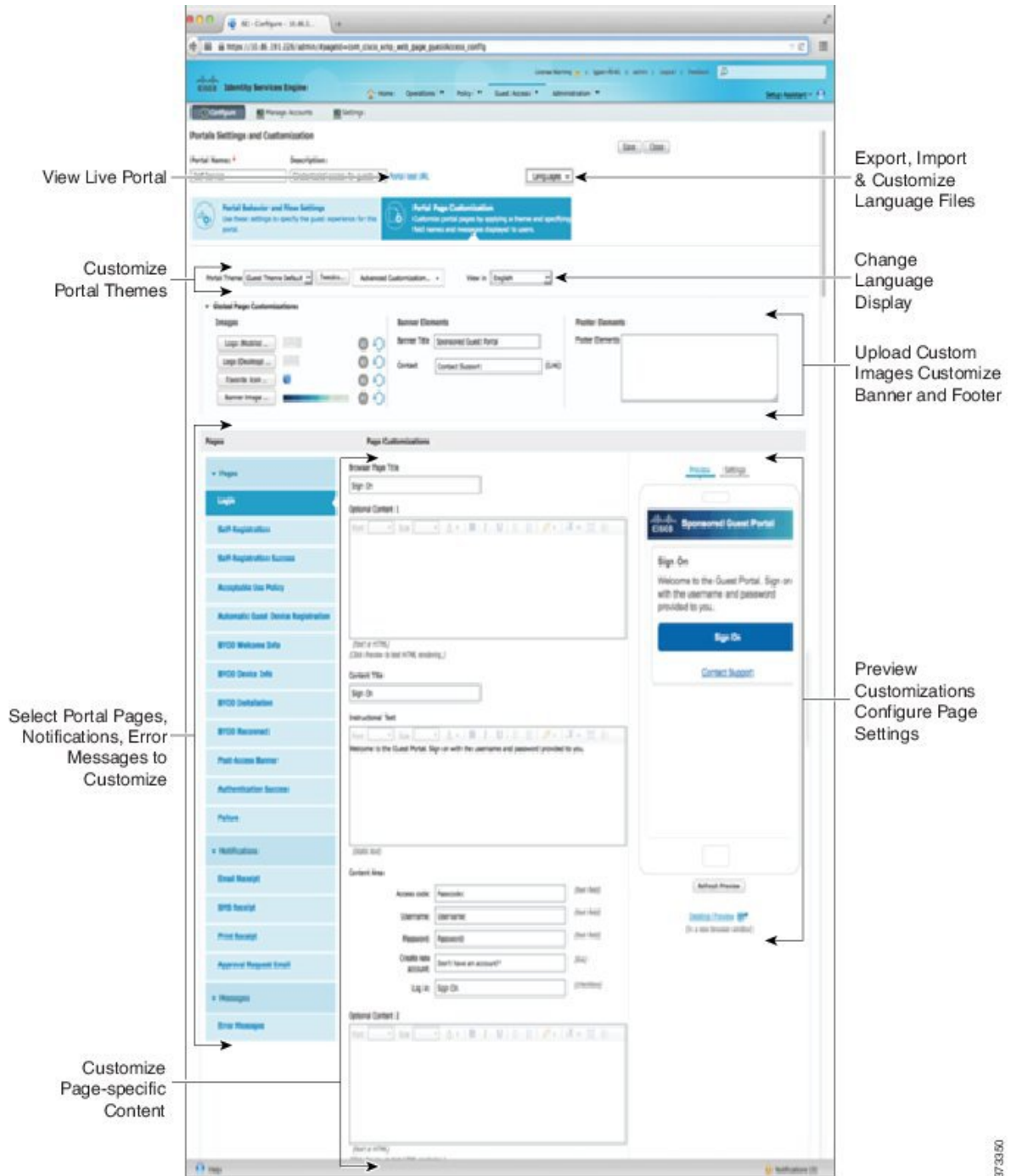
You can edit, duplicate, and create more portals. You can also fully customize the portal appearance and, therefore, the portal experience. You can customize each individual portal without affecting other portals.

You can customize various aspects of the portal interface that apply to the entire portal or to specific pages of the portal, such as:

- Themes, images, colors, banners, and footers
- Languages used for displaying portal text, error messages, and notifications
- Titles, content, instructions, and field and button labels

- Notifications sent to guests via email, SMS, and printer (applies only to the Self-Registered Guest and Sponsor portals)
- Error and informational messages displayed to users
- For the the Self-Registered Guest and Sponsor portals, you can create custom fields to gather guest information specific to your needs

Figure 46: Portal Page Layout for Customization



[ISE Community Resource](#)

For more information about customizing web portals, see [ISE Portal Builder](#) and [HowTo: ISE Web Portal Customization Options](#).

Customization Methods

There are several different ways to customize the end user portals pages, which require different levels of knowledge.

- **Basic:** You can modify the portal Customization page:
 - Upload banners and logos
 - Change some colors (except for buttons)
 - Change the text on the screens, and the language used on the entire portal
- **Intermediate**
 - Use the minieditor to add HTML and Javascript



Note Before you can enter HTML in a minieditor, click the HTML icon.

- Use the jQuery mobile theme roller to change the color of all page elements
- **Advanced**
 - Manually modify properties and CSS files.

After you customize your portal, you can create multiple portals (of the same type) by duplicating it. For example, if you customized your Hotspot Guest portal for one business entity, you can duplicate it and make minor changes to create custom Hotspot Guest portals for other business entities.

Tips for Customizing Portals with the Mini Editors

- Long words in a minieditor box may scroll off the screen area of the portal. You can break the line with the HTML paragraph attribute `style="word-wrap: break-word"`. For example:


```
<p style="word-wrap:break-word">
thisisaverylonglineoftextthatwillexceedthewidthofthelacethatyouwanttoputitsousethisstructure
</p>
```
- When you use HTML or javascript to customize portal pages, make sure that you use valid syntax. Cisco ISE doesn't validate the tags and code that you enter into a minieditor. Invalid syntax may cause problems during the portal flow.

Portal Content Types

Cisco ISE provides a default set of portal themes that you can use “as is” or customize by using the existing CSS files as models to create new custom files. However, you can alter the appearance of the portals without using customized CSS files.

For instance, if you want to use unique corporate logos and banner images, you can simply upload and use these new image files. You can customize the default color scheme by changing the color of the different

elements and areas of the portals. You can even choose the language in which you want to view the custom changes as you make them.

When you design images to replace the logos and banner, make the images as close to the following pixel size as you can:

Banner	1724 X 133
Desktop Logo	86 X 45
Mobile Logo	80 X 35

Note that ISE resizes the images to fit the portal, but images that are too small may not look right after resizing.

To perform advanced customization, such as changing the page layout or adding video clips or advertisements to your portal pages, you can use your own custom CSS files.

These types of changes within a specific portal are applied globally to all the pages of that portal. Changes to the page layout can be applied either globally or to just one specific page in the portal.

Portal Page Titles, Content, and Labels

You can customize the titles, text boxes, instructions, field and button labels, and other visual elements that the guest views on the end-user web portal pages. While you are customizing the page, you can even edit the page settings dynamically.

These changes are applied only to the specific page that you are customizing.

Basic Customization of Portals

Select a predefined theme that best suits your needs, and use most of its default settings. You can then do some basic customization, such as:

- [Modify the Portal Theme Colors, on page 513](#)
- [Change the Portal Icons, Images, and Logos, on page 515](#)
- [Update the Portal Banner and Footer Elements, on page 515](#)
- [Change the Portal Display Language, on page 514](#)
- [Change the Titles, Instructions, Buttons, and Label Text, on page 516](#)
- [Format and Style Text Box Content, on page 516](#)



Tip You can [View Your Customization, on page 520](#) as you make the updates.

Modify the Portal Theme Colors

You can customize the default color scheme in the default portal themes and change the color of the different elements and areas of the portals. These changes apply to the entire portal that you are customizing.

If you plan to change the portal colors, be aware of the following:

- You cannot use this option to change the color scheme in any of the custom portal themes that you may have imported for use with this portal. You must edit the custom theme CSS file to change its color settings.
- After changing the colors in a portal theme, if you select another portal theme from the **Portal Theme** drop-down menu, the changes are lost in the original portal theme and it reverts to its default colors.
- If you tweak the colors of a portal theme with an already modified color scheme and then reset its colors before saving it, the color scheme reverts to its default colors and any previous modifications are lost.

-
- Step 1** Navigate to these portals:
- For Guest portals, choose **Work Centers > Guest Access > Portals & Components > Configure > Guest Portals > Edit > Portal Page Customization**.
 - For Sponsor portals, choose **Guest Access > Portals & Components > Sponsor Portals > Edit > Portal Page Customization**.
- Step 2** Select one of the default themes from the **Portal Theme** drop-down list.
- Step 3** Click **Tweaks** to override some of the color settings in the selected default portal theme.
- Change the color settings for the banner and page backgrounds, text, and labels.
 - If you want to revert to the theme's default color scheme, click **Reset Colors**.
 - Click **OK** if you want to view the color changes in **Preview**.
- Step 4** Click **Save**.
-

Change the Portal Display Language

You can choose the language in which you want to view the custom changes as you make them. This change applies to the entire portal that you are customizing.

-
- Step 1** Navigate to these portals:
- For Sponsor portals, choose **Work Centers > Guest Access > Portals & Components > Sponsor Portals > Edit > Portal Page Customization > Global Customization**.
 - For Device portals, choose **Administration > Device Portal Management > (any Portals) > Edit > Portal Page Customization > Global Customization**.
- Step 2** From the **View In** drop-down list, choose the language in which you want to view the text while customizing the page. The drop-down list includes all languages in the language file associated with the specific portal.
-

What to do next

Make sure that you update any changes made in the selected language while customizing the portal page into all the supported language properties files.

Change the Portal Icons, Images, and Logos

If you want to use unique corporate logos, icons, and banner images, you can simply replace the existing images by uploading your custom images. Supported image formats include .gif, .jpg, .jpeg, and .png. These changes apply to the entire portal that you are customizing.

Before you begin

To include images in the footer of the portal, for instance in an advertisement, you should be able to access an external server that has these images.

-
- Step 1** Navigate to these portals:
- For Guest portals, choose **Work Centers > Guest Access > Portals & Components > Guest Portals > Edit > Portal Page Customization**.
 - For Sponsor portals, choose **Work Centers > Guest Access > Portals & Components > Configure > Sponsor Portals > Edit > Portal Page Customization**.
 - For Device portals, choose **Administration > Device Portal Management > (any Portals) > Edit > Portal Page Customization**.
- Step 2** Under **Images**, click any of the logos, icons, and image buttons and upload your custom images.
- Step 3** Click **Save**.
-

Update the Portal Banner and Footer Elements

You can customize the information that appears in the banner and footer sections of every page in the portal. These changes apply to the entire portal that you are customizing.

-
- Step 1** Navigate to these portals:
- For Guest portals, choose **Work Centers > Guest Access > Portals & Components > Guest Portals > Edit > Portal Page Customization**.
 - For Sponsor portals, choose **Work Centers > Guest Access > Portals & Components > Sponsor Portals > Edit > Portal Page Customization**.
 - For Device portals, choose **Administration > Device Portal Management > (any Portals) > Edit > Portal Page Customization**.
- Step 2** Change the **Banner title** that appears on every portal page.
- Step 3** Include these links for the guests who use your portals:
- **Help**—Online help (provided for only the Sponsor and My Devices portals).
 - **Contact**—Technical support (set up the Support Information page to enable this).
- Step 4** Add a disclaimer or a copyright notice in the **Footer Elements** to appear on the bottom of every portal page.
- Step 5** Click **Save**.
-

Change the Titles, Instructions, Buttons, and Label Text

You can update all the text that is displayed in the portal. Each UI element on the page that you are customizing has a minimum and maximum range for the number of characters that you can enter. When available in some of the text blocks, you can use a mini-editor to apply visual styling to the text. These changes apply only to the specific portal page you are customizing. These page elements are different for email, SMS, and print notifications.

Step 1 Navigate to these portals:

- For Guest portals, choose **Work Centers > Guest Access > Portals & Components > Configure > Guest Portals > Edit > Portal Page Customization**.
- For Sponsor portals, choose **Work Centers > Guest Access > Portals & Components > Sponsor Portals > Edit > Portal Page Customization**.
- For Device portals, choose **Administration > Device Portal Management > (any Portals) > Edit > Portal Page Customization**.

Step 2 Under **Pages**, choose the page that you want to change.

Step 3 Under **Page Customizations**, update any of the displayed UI elements. All pages contain **Browser Page Title**, **Content Title**, **Instructional Text**, **Content**, and two **Optional Content** text blocks. The fields in the **Content** area are specific to each page.

Format and Style Text Box Content

Use the mini-editor that is available in the **Instructional Text**, **Optional Content 1**, and **Optional Content 2** text boxes to do basic formatting of the text. These changes apply only to the specific portal pages that you are customizing.

Use the **Toggle Full Screen** button to increase and decrease the size of the text boxes as you work in them.

Step 1 Navigate to these portals:

- For Guest portals, choose **Work Centers > Guest Access > Portals & Components > Guest Portals > Edit > Portal Page Customization**.
- For Sponsor portals, choose **Work Centers > Guest Access > Portals & Components > Sponsor Portals > Edit > Portal Page Customization**.
- For Device portals, choose **Administration > Device Portal Management > (any Portals) > Edit > Portal Page Customization**.

Step 2 Under **Pages**, choose the page that you want to change.

Step 3 Under **Page Customizations**, in the **Instructional Text** and **Optional Content** text blocks, you can:

- Change the font, size, and color of the text.
- Style the text as bold, italics, or underlined.
- Create bulleted and numbered lists.

Note You can use the **Toggle HTML Source** button to view the HTML tags that were applied to the text that you formatted using the mini-editor. If you edit the text in the **HTML Source** view, click the **Toggle HTML Source** button again, before saving your changes in the **Portal Page Customization** window.

Variables for Portal Pages Customization

The navigation paths for these portal page text boxes are:

- For Guest portals, choose **Work Centers > Guest Access > Portals & Components > Guest Portals > Edit > Portal Page Customization > Pages**.
- For Sponsor portals, choose **Work Centers > Guest Access > Portals & Components > Sponsor Portals > Edit > Portal Page Customization > Pages**.
- For Device portals, choose **Administration > Device Portal Management > (any Portals) > Edit > Portal Page Customization > Pages**.

Use these variables when creating templates for portal content and guest notifications to enable consistency in the information presented to the portal users (guests, sponsors, and employees). Substitute text with the variable names listed here for each of the portals in the **Instructional Text**, **Optional Content 1**, and **Optional Content 2** text boxes.

Table 35: List of Variables for Guest Portals

Display Name	Substitute with Variable Name
Access code Use to provide an access code to guests using either email, text, or print notifications.	ui_access_code
BYOD IOS SSID Use to specify the network that a device should connect to after on-boarding in a dual SSID flow.	ui_byod_success_ios_ssid
Client Provisioning Agent Type Use to specify the currently configured agent in the client provisioning policy, such as the AnyConnect agent.	ui_client_provision_agent_type
Client Provisioning Agent URL Use to specify the download URL for the posture agent.	ui_client_provision_agent_url

Display Name	Substitute with Variable Name
Client Provisioning agent install minutes Use to notify guests the amount of time (set by the remediation timer) in which they must complete the installation instructions on the Client Provisioning window. If guests do not complete the installation instructions before the timer expires, they must refresh the browser page and go through the login process again.	ui_client_provision_install_agent_mins
Company	ui_company
Email address	ui_email_address
End date and time	ui_end_date_time
First name	ui_first_name
Last name	ui_last_name
Location name	ui_location_name
Maximum registered devices	ui_max_reg_devices
Maximum simultaneous logins	ui_max_siml_login
Password	ui_password
Person being visited (email)	ui_person_visited
Phone number	ui_phone_number
Reason for visit	ui_reason_visit
SMS Provider	ui_sms_provider
SSID Use to specify the wireless network that a guest can use to connect to the network.	ui_ssid
Start date and time	ui_start_date_time
Time left	ui_time_left
Username	ui_user_name

Table 36: List of Variables for Sponsor Portals

Display Name	Substitute with Variable Name
Guest - Company	ui_guest_company
Guest - Email address	ui_guest_email_address

Display Name	Substitute with Variable Name
Guest - End date and time	ui_guest_end_date_time
Guest - First name	ui_guest_first_name
Guest - Last name	ui_guest_last_name
Guest - Location name	ui_guest_location_name
Guest - Maximum registered devices	ui_guest_max_reg_devices
Guest - Maximum simultaneous logins	ui_guest_max_siml_login
Guest - Password	ui_guest_password
Guest - Person being visited (email)	ui_guest_person_visited
Guest - Phone number	ui_guest_phone_number
Guest - Reason for visit	ui_guest_reason_visit
Guest - SMS Provider	ui_guest_sms_provider
Guest - SSID Use to specify the wireless network that a guest can use to connect to the network.	ui_guest_ssid
Guest - Start date and time	ui_guest_start_date_time
Guest - Time left	ui_guest_time_left
Guest - Username	ui_guest_user_name
Username Use to specify the username of the user logged into the portal.	ui_sponsor_user_name

Table 37: List of Variables for MDM Portals

Display Name	Substitute with Variable Name
MDM - Vendor Name	ui_mdm_vendor_name

Table 38: List of Variables for My Devices Portals

Display Name	Substitute with Variable Name
MyDevices - Login Failure Rate Limit	\$(user_login_failure_rate_limit)\$
MyDevices - Max Devices to Register	ui_max_register_devices

Display Name	Substitute with Variable Name
MyDevices - User Name Use to specify the username of the user logged into the portal.	\$session_username\$

View Your Customization

You can view how your customization will display to the portal users (guests, sponsors, or employees).

Step 1 Click **Portal test URL** to view your changes.

Step 2 (Optional) Click **Preview** to dynamically view how your changes appear on various devices:

- Mobile devices: View your changes under **Preview**.
- Desktop devices: Click **Preview** and then click **Desktop Preview**.

If the changes are not displayed, click **Refresh Preview**. The portal displayed is only meant for viewing your changes; you cannot click buttons or enter data.

Note The test portal does not support RADIUS sessions, so you won't see the entire portal flow for all portals. BYOD and Client Provisioning are examples of portals that depend on RADIUS sessions. If you have more than one PSN, Cisco ISE chooses the first active PSN.

Custom Portal Files

The custom portal files menu lets you upload your own files to the ISE server, which you can use to customize all user facing portals (except for the Admin portal). The files you upload are stored on the PSN and synchronized to all PSNs.

Supported file types are:

- .png, .gif, .jpg, .jpeg, .ico: For backgrounds, announcements, and advertisements
- .htm, .html, .js, .json, .css, .m4a, .m4v, .mp3, .mp4, .mpeg, .ogg, .wav: For advanced customization (for example, portal builder)

File sizes are limited to:

- 20 MB per file
- 200 MB total of all files

The path column in the list of files displays the URL to the file on this server, which you can use to reference it outside the mini-editor. If the file is an image, when you click the link, it opens a new window that displays the image.

Uploaded files can be referenced by all portal types, except the Admin portal, in the mini-editors under **Portal Page Customization**. To insert the file into a mini-editor, click **Insert File**. Toggle to the HTML Source view, and you will see the inserted file surrounded by the appropriate HTML tags.

You can also view the displayable uploaded files in your browser from outside of ISE, for testing. The URL is https://ise_ip:8443/portal/customFiles/filename.

Advanced Customization of Portals

If you do not want to use one of the default portal themes provided by Cisco ISE, you can customize the portal to suit your needs. To do so, you must have experience working with CSS and Javascript files and the jQuery Mobile ThemeRoller application.

You cannot alter the default portal themes, but you can:

- [Export a Portal's Default Theme CSS File, on page 526](#) and use it as a base for creating a custom portal theme.
- [Create a Custom Portal Theme CSS File, on page 526](#) by editing the default portal theme and saving it as a new file.
- [Import the Custom Portal Theme CSS File, on page 536](#) and apply it to the portal.

Depending on your expertise and requirements, you can perform various types of advanced customization. You can use predefined variables to enable consistency in displayed information, add advertisements to your portal pages, use HTML, CSS and Javascript code to customize your content, and modify the portal page layout.

You modify the portal by adding HTML, CSS, and javascript into the content boxes on the **Portal Page Customization** tab of each portal. This document has examples of customization with HTML and CSS. Examples using javascript are on the ISE community here: <http://cs.co/ise-community>. More HTML, CSS, and Javascript examples are on the ISE community here: <https://community.cisco.com/t5/security-documents/how-to-ise-web-portal-customization-options/ta-p/3619042>.



Note TAC does not support Javascript customizations of Cisco ISE portals. If you are having problems with Javascript customizations, please post your questions to the ISE community <https://community.cisco.com/t5/identity-services-engine-ise/bd-p/5301j-disc-ise>.

Enable Advanced Portal Customization

Cisco ISE allows you to customize the content that displays on your end-user portals. You can enter HTML, CSS, and Javascript code in the text boxes on the different pages listed under **Portal Page Customization**.

-
- Step 1** Choose **Administration > System > Admin Access > Settings > Portal Customization**.
- Step 2** Verify that **Enable portal customization with HTML** is checked by default. This setting enables you to include HTML tags in the **Instructional Text**, **Optional Content 1** and **Optional Content 2** fields.
- Step 3** Check **Enable portal customization with HTML and Javascript** if you want to do advanced JavaScript customization by including `<script>` tags in the **Instructional Text**, **Optional Content 1** and **Optional Content 2** fields.
-

Portal Theme and Structure CSS Files

If you have experience with working with CSS files, you can customize the default portal theme CSS files to alter the portal presentation and manipulate elements such as the page layout, colors, and fonts. Customizing the CSS files provides you with flexibility and control in specifying the presentation characteristics, it enables you to share formatting across multiple pages, and it reduces the complexity and repetition in the structural content.

Cisco ISE end-user portals use two distinct types of CSS files: `structure.css` and `theme.css`. Every portal theme has its own `theme.css` file, but there is only one `structure.css` file per portal type; for example `guest.structure.css` for Guest portals, `sponsor.structure.css` for Sponsor Portals, and `mydevices.structure.css` for My Devices portals.

The `structure.css` provides the styling for the page layout and structure. It defines the positioning of elements on each page and also includes jQuery Mobile structure styles. You can only view the `structure.css` file, but you cannot edit it. However, when you change the page layout within `theme.css` files, import these files into the portal, and apply them, the most recent changes take priority over the `structure.css` styles.

The `theme.css` files specify styles such as fonts, button colors, and header background. You can export the `theme.css` files, change the theme settings, and import them to use as custom themes for your portal. Any page layout style changes made to the `theme.css` files take priority over the styles that are defined in the `structure.css` file.

You cannot alter any of the Cisco provided default portal `theme.css` files. However, you can edit the settings in the files and save them to a new custom `theme.css` file. You can make further edits to the custom `theme.css` file, but when you import it back into Cisco ISE, remember to use the same theme name you originally used for it. You cannot use two different theme names for the same `theme.css` file.

For example, you can use a default `green theme.css` file to create a new custom `blue theme.css` file and name it as `Blue`. You can then edit the `blue theme.css` file, but when you import it again, you must reuse the same `Blue` theme name. You cannot call it `Red`, since Cisco ISE checks for the relationship between a filename and its name and the uniqueness of the theme's name. You can however edit the `blue theme.css` file, save it as `red theme.css`, import the new file, and name it as `Red`.

About Changing Theme Colors with jQuery Mobile

The color scheme of Cisco's end-user portals is compatible with jQuery ThemeRoller. You can easily edit the colors for an entire portal using the ThemeRoller web site.

ThemeRoller color “swatches” contain a unique color scheme, which defines the colors, textures, and font settings for the primary UI elements, such as toolbars, content blocks, buttons, list items, and font text-shadow. A color scheme also defines the settings for various interaction states of the buttons: normal, hover, and pressed.

Cisco uses three swatches:

- Swatch A—The default swatch.
- Swatch B—Defines emphasized elements, such as an **Accept** button.
- Swatch C—Defines critical elements such as alerts, error messages, invalid input fields, and delete buttons.

You cannot apply additional swatches, unless you add HTML code (to the Optional Content, for example) with elements that use the newly added swatches.

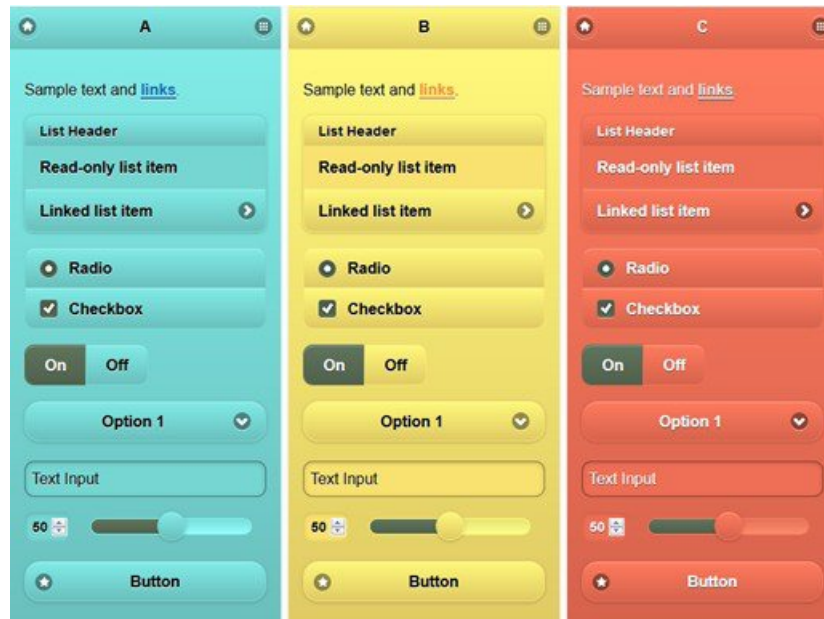
To edit the default Cisco-provided CSS files or create new files based on the CSS classes and structures defined in the default themes, use the required version of [jQuery Mobile ThemeRoller \(Release 1.3.2\)](#).

For additional information on swatches and themes in jQuery Mobile ThemeRoller, see "Theming Overview" in [Creating a Custom Theme with ThemeRoller](#). Use the online help in jQuery Mobile ThemeRoller to learn how to download, import, and share your custom themes.

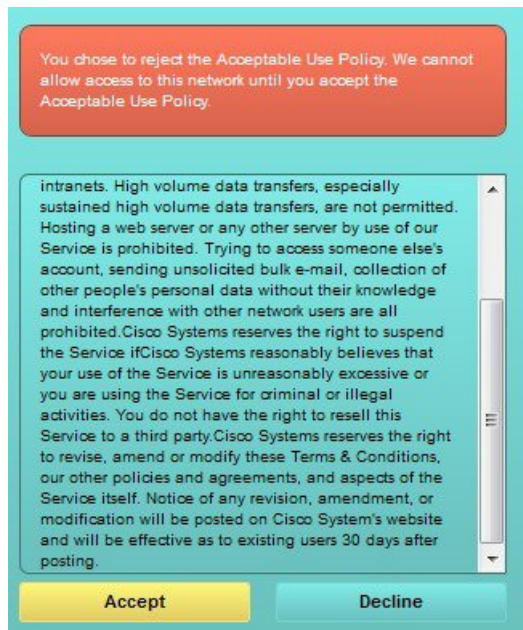
For tutorials on how to use HTML, CSS, and Javascript code to customize the text and content that appears on your portal pages, visit [Codecademy](#).

Example of a Theme That Shows Cisco Swatches

To demonstrate how swatches are used, the default theme for the Guest Portal was edited in ThemeRoller to show the differences in color.



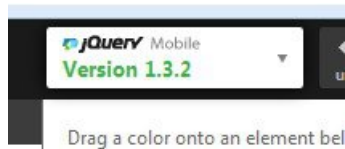
The following screen shows a guest portal logon error (swatch C) along with a button that takes an action from the user (swatch B), and the rest of the screen is Swatch A.



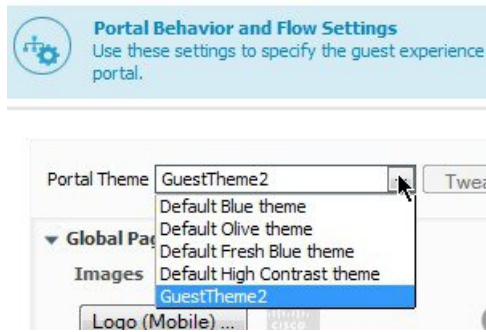
Change Theme Colors with jQuery Mobile

Before you begin

Make sure you are using version 1.3.2 of jQuery Mobile ThemeRoller. The version you are using is displayed in the top-left corner of the screen, as shown below.



- Step 1** Export an existing theme from the portal you wish to change by clicking the **Configuration** tab on the portal.
 - Step 2** Choose **Advanced Customization > Export/Import Themes**.
 - Step 3** In the **Custom Theming** dialog, export the theme you want to update.
 - Step 4** Open that theme in a text editor, select all, and copy.
 - Step 5** Paste that text (CSS) into the jQuery web site's **Import Theme** field.
 - Step 6** Make your changes in the jQuery Mobil web-based application.
 - Step 7** Export the updated theme from the jQuery website (the export format is ZIP).
 - Step 8** Unzip the updated theme, and extract the updated theme in themes folder to your PC. The name of the theme is the one you provided on the jQuery website.
 - Step 9** Import the extracted CSS theme file into your portal in the portal configuration page's **Custom Theming** dialog.
- You can switch back and forth between the old theme and the new theme by clicking the **Portal Theme** drop-down list on the **Portal Configuration** window.



Location Based Customization

When guest accounts are created, you can associate them with a location and specify a Service Set Identifier (SSID) attribute. Both the location and SSID are available as CSS classes that you can use to apply different CSS styles to portal pages, based on the guest's location and SSID.

For example:

- Guest location—When guests with accounts that have *San Jose* or *Boston* as their locations log into a credentialed Guest portal, one of these classes is available on every portal page: **guest-location-san-jose** or **guest-location-boston**.
- Guest SSID—For an SSID named *Coffee Shop Wireless*, the following CSS class is available on every portal page: **guest-ssid-coffee-shop-wireless**. This SSID is the one you specified on the guest account and not the SSID that the guests connected to when they logged in.



Note This information applies only to the credentialed Guest portals after the guests log in.

You can also specify locations when you add devices such as switches and Wireless LAN Controllers (WLCs) to a network. This location is also available as a CSS class that you can use to apply different CSS styles to portal pages depending on the network device's location.

For example, if a WLC is assigned to *Seattle* and guests are redirected to Cisco ISE from the Seattle-WLC, the following CSS class is available on every portal page: **device-location-my-locations-usa-seattle**.

Related Topics

[Customize Greetings Based on Guest Location](#), on page 532

User Device Type Based Customization

Cisco ISE detects the type of client device (guest, sponsor, or employee) to access your company's network or end-user web portals (Guest, Sponsor, and Device). It is detected either as a mobile device (Android, iOS, and so on) or a desktop device (Windows, MacOS, and so on). The device type is available as a CSS class that you can use to apply different CSS styles to portal pages based on the user's device type.

When a user logs in to any of the Cisco ISE end-user web portals, the following class is available on their portal pages: **cisco-ise-mobile** or **cisco-ise-desktop**.

Related Topics

[Customize Greetings Based on User Device Type](#), on page 533

Export a Portal's Default Theme CSS File

You can download a default portal theme provided by Cisco and customize it to suit your needs. You can use it as a base for performing advanced customization.

-
- Step 1** Navigate to these portals:
- For Guest portals, choose **Work Centers > Guest Access > Portals & Components > Guest Portals > Edit > Portal Page Customization > Pages**.
 - For Sponsor portals, choose **Work Centers > Guest Access > Portals & Components > Sponsor Portals > Edit > Portal Page Customization > Pages**.
 - For Device portals, choose **Administration > Device Portal Management > (any Portals) > Edit > Portal Page Customization > Pages**.
- Step 2** From the **Advanced Customization** drop-down list, choose **Export/Import Themes**.
- Step 3** In the **Custom Theming** dialog box, use the drop-down list to select the theme that you want to customize.
- Step 4** Click **Export Theme CSS** to download a default *theme.css* file to customize.
- Step 5** Click **Save** to save the file to your desktop.
-

Create a Custom Portal Theme CSS File

You can create a custom portal theme by customizing an existing default portal theme and saving the changes in a new portal *theme.css* file. You can modify the default theme settings and the swatches to make global changes to the selected portal.

Before you begin

- Download the *theme.css* file from the portal that you want to customize to your desktop .
- This task requires experience working with HTML, CSS, and Javascript code.
- Use Release 1.3.2 of jQuery Mobile ThemeRoller.

-
- Step 1** Import the downloaded portal *theme.css* file contents into the jQuery Mobile ThemeRoller tool.

Tip You can [View Your Customization, on page 537](#) as you make your changes.

- Step 2** (Optional) [Embed Links in Portal Content, on page 527](#)
- Step 3** (Optional) [Insert Variables for Dynamic Text Updates, on page 527](#)
- Step 4** (Optional) [Use Source Code to Format Text and Include Links, on page 528](#)
- Step 5** (Optional) [Add an Image as an Advertisement, on page 529](#)
- Step 6** (Optional) [Customize Greetings Based on Guest Location, on page 532](#)
- Step 7** (Optional) [Customize Greetings Based on User Device Type, on page 533](#)

- Step 8** (Optional) [Set Up Carousel Advertising, on page 530](#)
- Step 9** (Optional) [Modify the Portal Page Layout, on page 534](#)
- Step 10** Save the customized file as a new *theme.css* file.
- Note** You cannot save the edits to the default CSS theme files. You can only create new custom files with any edits you have made.
- Step 11** When your new *theme.css* file is ready, you can import it into Cisco ISE.
-

Embed Links in Portal Content

You can add links to enable guests to access various websites from the portal pages. These changes apply only to the specific portal page that you are customizing.

Use the **Toggle Full Screen** option to increase and decrease the size of the fields as you work in them.

- Step 1** Navigate to these portals:
- For Guest portals, choose **Work Centers > Guest Access > Portals and Components > Guest Portals > Edit > Portal Page Customization**.
 - For Sponsor portals, choose **Work Centers > Guest Access > Portals and Components > Sponsor Portals > Edit > Portal Page Customization**.
 - For Device portals, choose **Administration > Device Portal Management > (any Portals) > Edit > Portal Page Customization**.
 - For Certificate Provisioning portal, choose **Administration > Device Portal Management > Certificate Provisioning > Edit > Portal Page Customization**.
- Step 2** Under **Pages**, choose the page that you want to update.
- Step 3** Under **Page Customizations**, use the mini-editor provided with the **Optional Content** text blocks to add links to portal pages.
- Step 4** Click the **Create Link** button.
Link Properties dialog box appears.
- Step 5** Enter the **URL** and the text you want to hyperlink in the **Description** window for the URL.
For the link to work correctly, include the protocol identifier in the URL. For example, use `http://www.cisco.com` instead of `www.cisco.com`.
- Step 6** Click **Set** and then click **Save**.
You can use the **Toggle HTML Source** option to view the HTML tags that were applied to the text that you formatted using the mini-editor.
-

Insert Variables for Dynamic Text Updates

You can also create templates for text displayed on the portal by substituting predefined variables (`$variable$`) that dynamically update the content. This enables consistency in the text and information that you display to guests. These changes apply only to the specific portal pages that you are customizing.

Use the **Toggle Full Screen** option to increase and decrease the size of the fields as you work in them.

-
- Step 1** Navigate to these portals:
- For Guest portals, choose **Work Centers > Guest Access > Portals and Components > Guest Portals > Edit > Portal Page Customization**.
 - For Sponsor portals, choose **Work Centers > Guest Access > Portals and Components > Sponsor Portals > Edit > Portal Page Customization**.
 - For Device portals, choose **Administration > Device Portal Management > (any Portals) > Edit > Portal Page Customization**.
- Step 2** Under **Pages**, choose the page you want to update.
- Step 3** Under **Page Customizations**, use the mini-editor provided with the **Instructional Text**, **Optional Content 1**, and **Optional Content 2** fields to create text templates for the portal pages.
- For example, you can create a single welcome message template for multiple guests, but personalize the message that displays to the guests after they successfully log in and connect to the network.
- Step 4** Enter the information in the fields as you normally would.
- For example, you could enter a welcome message for your portal:
- ```
Welcome to our company's Guest portal,
```
- Step 5** At the point where you want to substitute a variable for the text, click **Insert Variable**.  
A list of variables appears in the pop-up menu.
- Step 6** Select the variable that you want to substitute in your text.
- For example, choose **First name** to display each guest's first name in the welcome message. The variable `$ui_first_name$` is inserted at your cursor position:
- ```
Welcome to our company's Guest portal,$ui_first_name$.
```
- This is the welcome message that would appear on the portal welcome page for guests whose first name is John: **Welcome to our company's Guest portal, John.**
- Step 7** Continue to use the list of variables as needed until you have completed entering the information in the text boxes.
- Step 8** Click **Save**.
- You can use the **Toggle HTML Source** option to view the HTML tags that were applied to the text that you formatted using the mini-editor.
-

Use Source Code to Format Text and Include Links

Besides using the mini-editor's formatting and link icons with plain text, you can also use HTML, CSS, and Javascript code to customize text that displays on the portal pages. These changes apply only to the specific portal pages that you are customizing.

Use the **Toggle Full Screen** option to increase and decrease the size of the text boxes as you work in them.

Before you begin

Ensure that **Enable portal customization with HTML** is enabled by default in **Administration > System > Admin Access > Settings > Portal Customization**.

Step 1 Navigate to these portals:

- For Guest portals, choose **Work Centers > Guest Access > Portals & Components > Guest Portals > Edit > Portal Page Customization**.
- For Sponsor portals, choose **Work Centers > Guest Access > Portals & Components > Sponsor Portals > Edit > Portal Page Customization**.
- For Device portals, choose **Administration > Device Portal Management > (any Portals) > Edit > Portal Page Customization**.

Step 2 Under **Pages**, choose the page that you want to update.

Step 3 Under **Page Customizations**, use the mini-editor provided with the **Instructional Text**, **Optional Content 1**, and **Optional Content 2** fields to enter and view source code.

Step 4 Click **Toggle HTML Source**.

Step 5 Enter your source code.

For example, to underline your text, enter:

```
<p style="text-decoration:underline;">Welcome to Cisco!</p>
```

For example, to include a link using HTML code, enter:

```
<a href="http://www.cisco.com">Cisco</a>
```

Important When inserting an external URL in the HTML code, make sure that you enter the absolute (entire) URL path, including “http” or “https”.

Step 6 Click **Save**.

Related Topics

[Enable Advanced Portal Customization](#), on page 521

Add an Image as an Advertisement

You can include images and advertisements to appear in specific areas of the portal pages.

Use the **Toggle Full Screen** option to increase and decrease the size of the text boxes as you work in them.

Before you begin

Ensure that **Enable portal customization with HTML** is enabled in **Administration > System > Admin Access > Settings > Portal Customization**.

Step 1 Navigate to these portals:

- For Guest portals, choose **Work Centers > Guest Access > Portals & Components > Guest Portals > Edit > Portal Page Customization**.

- For Sponsor portals, choose **Work Centers > Guest Access > Portals & Components > Sponsor Portals > Edit > Portal Page Customization**.
- For Device portals, choose **Administration > Device Portal Management > (any Portals) > Edit > Portal Page Customization**.

Step 2 Under **Pages**, choose the page that you want to update.

Step 3 Under **Page Customizations**, use the mini-editor provided with the **Instructional Text**, **Optional Content 1**, and **Optional Content 2** fields to enter and view source code.

Step 4 Click **Toggle HTML Source**.

Step 5 Enter your source code.

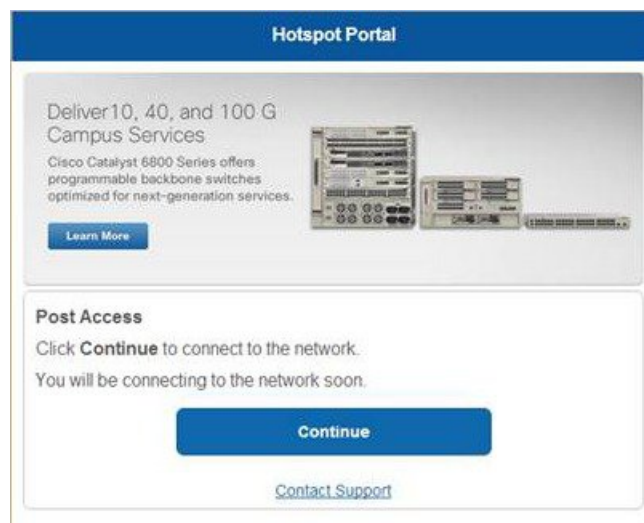
For example, to include a product advertisement and its image using HTML code on the Hotspot Guest portal post-access banner, enter this code in the **Optional Content 1** text box on the **Post-Access Banner** page:

```
<p style="text-decoration:underline;">Optimized for 10/40/100 Campus Services!</p>

```

Note When inserting an external URL in the HTML code, make sure that you enter the absolute (entire) URL path, including “http” or “https”.

Figure 47: Sample Image for an Advertisement



Step 6 Click **Save**.

Set Up Carousel Advertising

Carousel advertising is an advertisement format in which several product images or text descriptions are displayed and rotate in a repeating loop within a banner. Use carousel advertising on your guest portals to promote several related products or a variety of different products offered by your company.

Use the **Toggle Full Screen** option to increase and decrease the size of the text boxes as you work in them.

Before you begin

Choose **Administration > System > Admin Access > Settings > Portal Customization** and check **Enable portal customization with HTML and Javascript**.

Step 1 Navigate to these portals:

- For Guest portals, choose **Work Centers > Guest Access > Portals & Components > Guest Portals > Edit > Portal Page Customization**.
- For Sponsor portals, choose **Work Centers > Guest Access > Portals & Components > Sponsor Portals > Edit > Portal Page Customization**.
- For Device portals, choose **Administration > Device Portal Management > (any Portals) > Edit > Portal Page Customization**.

Step 2 Under **Pages**, choose the page that you want to update.

Step 3 Under **Page Customizations**, use the mini-editor provided with the **Instructional Text**, **Optional Content 1**, and **Optional Content 2** fields to enter and view source code.

Step 4 Click **Toggle HTML Source**.

Step 5 Enter your source code.

For example, to implement carousel advertising using product images on the Guest portals, enter the following HTML and Javascript code in the **Optional Content 1** field on the **Post-Access Banner** (for Hotspot portals) or **Post Login Banner** (for credentialed Guest portals) window:

```
<script>
var currentIndex = 0;
setInterval(changeBanner, 5000);

function changeBanner(){
var bannersArray = ["<img src='http://www.cisco.com/c/en/us/products/routers/index/_jcr_content/
content_parsys/overview/layout-overview/gd12v2/gd12v2-left/n21v1_cq/
n21v1DrawerContainer.img.jpg/1379452035953.jpg' width='100%' />",
"<img src='http://www.cisco.com/c/en/us/products/routers/index/_jcr_content/
content_parsys/overview/layout-overview/gd12v2/gd12v2-left/n21v1_cq_0/
n21v1DrawerContainer.img.jpg/1400748629549.jpg' width='100%' />",
"<img src='http://www.cisco.com/c/en/us/products/routers/index/_jcr_content/
content_parsys/overview/layout-overview/gd12v2/gd12v2-left/n21v1_cq_1/
n21v1DrawerContainer.img.jpg/1376556883237.jpg' width='100%' />"
];
var div = document.getElementById("image-ads");
if(div){
    currentIndex = (currentIndex<2) ? (currentIndex+1) : 0;
    div.innerHTML = bannersArray[currentIndex];
}
}
</script>
<style>
.grey{
color: black;
background-color: lightgrey;
}
</style>
<div class="grey" id="image-ads">
<img src='http://www.cisco.com/c/en/us/products/routers/index/_jcr_content/
content_parsys/overview/layout-overview/gd12v2/gd12v2-left/n21v1_cq/
n21v1DrawerContainer.img.jpg/1379452035953.jpg' />
</div>
```

For example, to implement carousel advertising using text product descriptions on the Guest portals, enter the following HTML and Javascript code in the **Optional Content 2** field on the **Post-Access Banner** (for Hotspot portals) or **Post Login Banner** (for credentialed Guest portals) window:

```
<script>
var currentIndex = 0;
setInterval(changeBanner, 2000);

function changeBanner(){
var bannersArray = ["Optimize branch services on a single platform while delivering an optimal
application experience across branch and WAN infrastructure", "Transform your Network Edge to
deliver high-performance, highly secure, and reliable services to unite campus, data center,
and branch networks", "Differentiate your service portfolio and increase revenues by delivering
end-to-end scalable solutions and subscriber-aware services"];

var colorsArray = ["grey", "blue", "green"];
var div = document.getElementById("text-ads");
if(div){
    currentIndex = (currentIndex<2) ? (currentIndex+1) : 0;
    div.innerHTML = bannersArray[currentIndex];
    div.className = colorsArray[currentIndex];
}
}
</script>
<style>
.grey{
color: black;
background-color: lightgrey;
}
.blue{
color: black;
background-color: lightblue;
}
.green{
color: black;
background-color: lightgreen;
}
</style>
<div class="grey" id="text-ads">
Optimize branch services on a single platform while delivering an optimal application
experience across branch and WAN infrastructure
</div>
```

Note When inserting an external URL in the HTML code, you must enter the absolute (entire) URL path, including “http” or “https”.

Step 6 Click **Save**.

Customize Greetings Based on Guest Location

This example shows how to customize the successful login message that your guests see after they log into a credentialed Guest portal (not Hotspot), based on the locations configured in their guest type.

Use the **Toggle Full Screen** option to increase and decrease the size of the fields as you work in them.

Step 1 Navigate to one of these portals:

- For Guest portals, choose **Work Centers > Guest Access > Portals & Components > Guest Portals > Edit > Portal Page Customization**.
- For Sponsor portals, choose **Work Centers > Guest Access > Portals & Components > Sponsor Portals > Edit > Portal Page Customization**.

Step 2 Under **Pages**, click **Authentication Success**.

Step 3 Under **Page Customizations**, use the mini-editor provided with the **Optional Content 1** fields to enter and view HTML source code.

Step 4 Click **Toggle HTML Source**.

Step 5 Enter your source code.

For example, to include a location-based greeting, enter this code in **Optional Content 1**:

```
<style>
  .custom-greeting {
    display: none;
  }
  .guest-location-san-jose .custom-san-jose-greeting {
    display: block;
  }
  .guest-location-boston .custom-boston-greeting {
    display: block;
  }
</style>
<div class="custom-greeting custom-san-jose-greeting">
  Welcome to The Golden State!
</div>
<div class="custom-greeting custom-boston-greeting">
  Welcome to The Bay State!
</div>
```

Guests will see a different message after successful logon, depending on their specific location.

Customize Greetings Based on User Device Type

You can customize the greetings that you send to your users (guest, sponsor, or employee) after they log into any of the Cisco ISE end-user web portals (Guest, Sponsor and Device), based on their client device type (mobile or desktop).

Use the **Toggle Full Screen** option to increase and decrease the size of the fields as you work in them.

Step 1 Navigate to these portals:

- For Guest portals, choose **Work Centers > Guest Access > Portals & Components > Guest Portals > Edit > Portal Page Customization**.
- For Sponsor portals, choose **Work Centers > Guest Access > Portals & Components > Sponsor Portals > Edit > Portal Page Customization**.
- For Device portals, choose **Administration > Device Portal Management > (any Portals) > Edit > Portal Page Customization**.

Step 2 Under **Pages**, choose the page that you want to update.

Step 3 Under **Page Customizations**, use the mini-editor provided with the **Optional Content 1** field to enter and view HTML source code.

Step 4 Click **Toggle HTML Source**.

Step 5 Enter your source code.

For example, to include a device type-based greeting on the AUP page, enter this code in the **Optional Content 1** field on the AUP window:

```
<style>
  .custom-greeting {
    display: none;
  }
  .cisco-ise-desktop .custom-desktop-greeting {
    display: block;
  }
  .cisco-ise-mobile .custom-mobile-greeting {
    display: block;
  }
</style>
<div class="custom-greeting custom-mobile-greeting">
  Try our New Dark French Roast! Perfect on the Go!
</div>
<div class="custom-greeting custom-desktop-greeting">
  We brough back our Triple Chocolate Muffin!
  Grab a seat and dig in!
</div>
```

Users will see a different greeting on the AUP page depending on the type of device they used to gain access to the network or portal.

Modify the Portal Page Layout

You can manipulate the overall layout of the pages; for example, you can add a sidebar to an AUP page that provides additional information or links to information.

Step 1 Add the following CSS code to the bottom of the custom *theme.css* file that you create and plan to apply to your portal. This changes the AUP page layout. The **Optional Content 1** field appears as a side bar in the desktop and mobile device mode.

```
#page-aup .cisco-ise-optional-content-1 {
  margin-bottom: 5px;
}
@media all and ( min-width: 60em ) {
  #page-aup .cisco-ise-optional-content-1 {
    float: left;
    margin-right: 5px;
    width: 150px;
  }
  #page-aup .cisco-ise-main-content {
    float: left;
    width: 800px;
  }
  #page-aup .cisco-ise-main-content h1,
  #page-aup .cisco-ise-main-content p {
    margin-right: auto;
    margin-left: -200px;
  }
}
```

You can then add links using HTML code in the **Optional Content 1** field for the AUP window for that portal.

Step 2 Navigate to these portals:

- For Guest portals, choose **Work Centers > Guest Access > Portal & Components > Guest Portals > Edit > Portal Page Customization**.
- For Sponsor portals, choose **Work Centers > Guest Access > Portal & Components > Sponsor Portals > Edit > Portal Page Customization**.
- For Device portals, choose **Administration > Device Portal Management > (any Portals) > Edit > Portal Page Customization**.

Step 3 Under **Pages**, choose the page for which you want to include a side bar.

Step 4 Under **Page Customizations**, use the mini-editor provided with the **Optional Content 1** field to enter and view source code.

Step 5 Click **Toggle HTML Source**.

Step 6 Enter your source code.

For example, to include a side bar for the AUP window, enter this code in the **Optional Content 1** field on the AUP window:

```
<ul data-role="listview">
  <li>Rent a Car</li>
  <li>Top 10 Hotels</li>
  <li>Free Massage</li>
  <li>Zumba Classes</li>
</ul>
```

Figure 48: View of a Side Bar on a Sample AUP Page (on a Desktop Device)

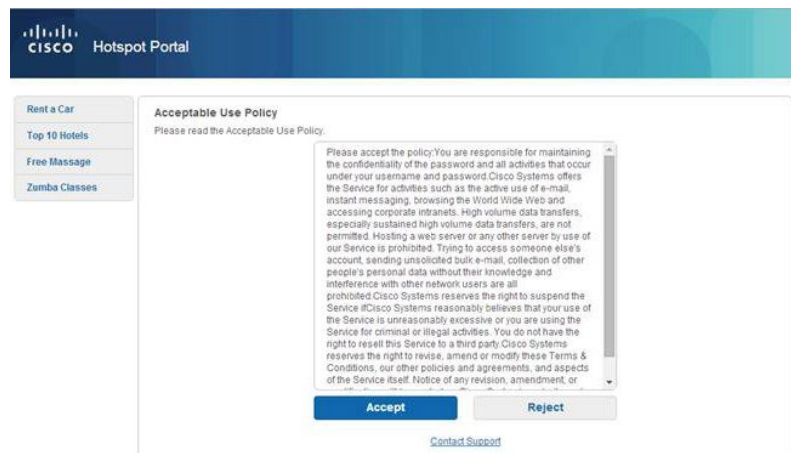
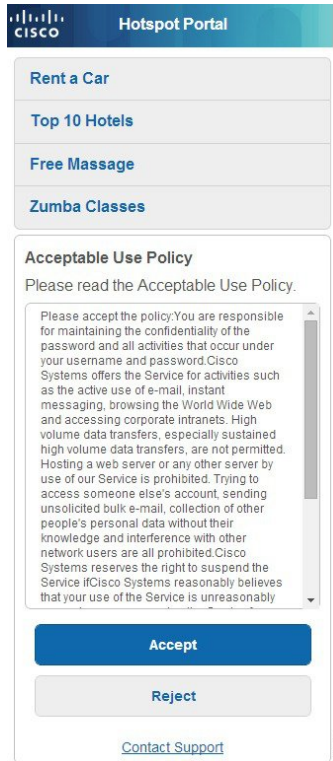


Figure 49: View of a Side Bar on a Sample AUP Page (on a Mobile Device)



Step 7 Click **Save**.

What to do next

You can customize other pages by entering different text or HTML code in the **Optional Content** fields.

Import the Custom Portal Theme CSS File

You can upload any custom *theme.css* file that you have created and apply it to any of your end-user portals. These changes apply to the entire portal that you are customizing.

Any time you edit a custom *theme.css* file and import it back into Cisco ISE, remember to use the same theme name you originally used for it. You cannot use two different theme names for the same *theme.css* file.

Step 1 Navigate to these portals:

- For Guest portals, choose **Work Centers > Guest Access > Portals & Components > Configure > Guest Portals > Edit > Portal Page Customization**.
- For Sponsor portals, choose **Work Centers > Guest Access > Portals & Components > Sponsor Portals > Edit > Portal Page Customization**.
- For Device portals, choose **Administration > Device Portal Management > (any Portals) > Edit > Portal Page Customization**.

- Step 2** From the **Advanced Customization** drop-down list, choose **Export/Import Themes**.
- Step 3** In the **Custom Theming** dialog box, click **Browse** to find your new *theme.css* file.
- Step 4** Enter a **Theme Name** for the new file.
- Step 5** Click **Save**.
-

What to do next

You can apply this custom portal theme to the portal that you want to customize.

1. Choose the updated theme from the **Portal Themes** drop-down list to apply to the entire portal.
2. Click **Save**.

Delete a Custom Portal Theme

You can delete any custom portal theme that you have imported into Cisco ISE, unless it is being used by one of your portals. You cannot delete any of the default themes provided by Cisco ISE.

Before you begin

The portal theme that you want to delete should not be used by any of the portals.

- Step 1** Navigate to these portals:
- For Guest portals, choose **Work Centers > Guest Access > Portals & Components > Guest Portals > Edit > Portal Page Customization**.
 - For Sponsor portals, choose **Work Centers > Guest Access > Portals & Components > Sponsor Portals > Edit > Portal Page Customization**.
 - For Device portals, choose **Administration > Device Portal Management > (any Portals) > Edit > Portal Page Customization**.
- Step 2** From the **Advanced Customization** drop-down list, choose **Delete Themes**.
- Step 3** Select the portal theme that you want to delete from the **Theme Name** drop-down list.
- Step 4** Click **Delete** and then **Save**.
-

View Your Customization

You can view how your customization will display to the portal users (guests, sponsors, or employees).

- Step 1** Click **Portal test URL** to view your changes.
- Step 2** (Optional) Click **Preview** to dynamically view how your changes appear on various devices:
- Mobile devices: View your changes under **Preview**.
 - Desktop devices: Click **Preview** and then click **Desktop Preview**.

If the changes are not displayed, click **Refresh Preview**. The portal displayed is only meant for viewing your changes; you cannot click buttons or enter data.

Note The test portal does not support RADIUS sessions, so you won't see the entire portal flow for all portals. BYOD and Client Provisioning are examples of portals that depend on RADIUS sessions. If you have more than one PSN, Cisco ISE chooses the first active PSN.

Portal Language Customization

The Guest, Sponsor, My Devices, and Client Provisioning portals are localized into all supported languages and locales. This includes text, labels, messages, field names, and button labels. If the client browser requests a locale that is not mapped to a template in Cisco ISE, the portals display content using the English template.

Using the Admin portal, you can modify the fields used for the Guest, Sponsor, and My Devices portals for each language individually, and you can add more languages. Currently, you cannot customize these fields for the Client Provisioning portal.

By default, each type of portal supports 15 languages. You select which language a portal uses, and optionally update page content for that language, on the **Portal Page Customization** window. Note, if you change fonts and content on the page for one language, those changes do not carry over into the other languages. The changes you make on the **Portal Page Customization** window are included when you export the Language File.

The supported languages are:

- Chinese Simplified
- Chinese Traditional
- Czech
- Dutch
- English
- French
- German
- Hungarian
- Italian
- Japanese
- Korean
- Polish
- Portuguese
- Russian
- Spanish



Note NAC and MAC agent installers and WebAgent pages are not localized.

To Edit the Language Used by a Portal

1. Open the portal that you want to edit.
2. On the **Portal Page Customization** tab, select the language that you want to edit in the **view in** drop-down list.
3. Change content, headings, and fonts as desired.
4. Save that portal configuration, and repeat this flow for the other languages that you want to update.

To Edit the Language File

Each **Portal Page Customization** window also provides a Language File. The Language File is a ZIP of attribute files that you can use to customize headings and text that are part of the portal flow, but is not available to customize on the **Portal Page Customization** window.

The Language File also contains the mapping to the particular browser locale setting along with all of the string settings for the entire portal in that language. If you change the browser locale setting for one language, the change is applied to all the other end-user web portals. For example, if you change the French.properties browser locale from fr,fr-fr,fr-ca to fr,fr-fr in the Hotspot Guest portal, the change is applied to the My Devices portal also.

You can export the zipped language file and make updates to it, including adding new languages or deleting existing ones you do not need.

For instructions about how to update the Language File, see:

- [Export the Language File, on page 539](#)
- [Add or Delete Languages from the Language File, on page 540](#)
- [Import the Updated Language File, on page 541](#)

Export the Language File

You can export the language file available for each portal type to edit and customize the existing values specified in it, and add or delete a language.



Note Only some of the dictionary keys in the language properties files support HTML in their values (text).

Step 1 Navigate to these portals:

- For Guest portals, choose **Work Centers > Guest Access > Portals & Components > Edit** .
- For Sponsor portals, choose **Work Centers > Configure > Portals & Components > Sponsor Portals > Edit** .
- For Device portals, choose **Administration > Device Portal Management > (any Portals) > Edit** .

Step 2 Click **Language File** and choose **Export** from the drop-down list.

Step 3 Save the zipped language file to your desktop.

Add or Delete Languages from the Language File

If a language you want to use for your portal type is missing from the language file, you can create a new language properties file and add it to the zipped language file. If there are languages you do not need, you can delete their language properties files.

Before you begin

Export the zipped language file available with each portal type in order to add or delete language properties files.

Step 1 Use any editor that displays UTF-8 (such as Notepad++) to open the predefined language file for the portal type to which you want to add or delete languages.

If you want to add or delete languages for more than one portal type, use all the appropriate portal properties files.

Step 2 To add a new language, save an existing language properties file as the new language properties file using the same naming convention of the other files in the zipped language file. For example, to create a new Japanese language properties file, save the file as `Japanese.properties` (*LanguageName.properties*).

Step 3 Associate the new language with its browser locale by specifying the browser local value in the first line of the new language properties file. For example, `LocaleKeys=ja,ja-jp` (`LocaleKeys=browser locale value`) should be the first line in the `Japanese.properties` file.

Step 4 Update all the values (text) of the dictionary keys in the new language properties file.

You cannot change the dictionary keys. You can update only their values.

Note Only some of the dictionary keys support HTML in their values (text).

What to do next

1. Zip all the properties files (new and existing) and create a new zipped language file. Do not include any folders or directories.



Note When using a Mac, extracting the ZIP file produces a DS store. When you compress the language file after editing, do not include the DS store in the ZIP. To learn methods of extracting the DS store, see <https://superuser.com/questions/198569/compressing-folders-on-a-mac-without-the-ds-store>.

2. Use a new name or its original name for the zipped language file.
3. Import the zipped language file into the specific portal you exported it from.

Import the Updated Language File

You can import an edited language file that you have customized by adding or deleting language properties files or by updating text in existing properties files.



Note Ensure that you do not copy and paste customization content from Word files. Alternately, choose **File > Save As** and save the Word file in HTML format. You can then copy and paste customization content from the HTML file.

-
- Step 1** Navigate to these portals:
- For Guest portals, choose **Work Centers > Guest Access > Portals & Components > Guest Portals > Edit** .
 - For Sponsor portals, choose **Work Centers > Guest Access > Portals & Components > Sponsor Portals > Edit** .
 - For Device portals, choose **Administration > Device Portal Management > (any Portals) > Edit** .
- Step 2** Click **Language File** and choose **Import** from the drop-down list.
- Step 3** Browse to find the new zipped language file on your desktop.
- Step 4** Import it back for the portal type from where you exported it.
-

What to do next

To display the changed text or the new language you added, select the specific language from the **View In** drop-down list.

Customization of Guest Notifications, Approvals, and Error Messages

Within in each portal, you can customize how guests receive notifications via email, SMS text messages, and print. Use these notifications to email, text, or print the login credentials:

- When guests use the Self-Registration Guest portal and successfully register themselves.
- When sponsors create guest accounts and want to provide the details to guests. When you create sponsor groups, you can determine whether to authorize sponsors to use SMS notifications. They can always use email and print notifications, if these facilities are available.

You can also customize email notifications to sponsors requesting that they approve a self-registering guest trying to gain access to the network. Additionally, you can customize the default error messages that display to guests and sponsors.

Customize Email Notifications

You can customize the information that is sent via email to guests.

Before you begin

- Configure the SMTP server to enable email notifications. Choose **Administration > System > Settings > SMTP Server**.
- Configure support for email notifications to guests. Choose **Work Centers > Guest Access > Settings > Guest Email Settings**. Check **Enable email notifications to guests**.
- Ensure that **Enable portal customization with HTML** is enabled by default in **Administration > System > Admin Access > Settings > Portal Customization**.

-
- Step 1** For Self-Registered Sponsor portals, choose **Work Centers > Guest Access > Portals & Components > Sponsor Portals > Edit > Portal Page Customization > Notify Guests > Email Notification**.
- Step 2** You can change the default **Logo (Email)** that was specified under **Global Page Customizations**.
- Step 3** Specify the **Subject** and **Email body**. Use predefined variables to specify the guest account information to be included in the email message. Use the mini-editor and HTML tags to customize the text.
- Step 4** Under **Settings**, you can:
- **Send username and password separately** in different emails. If you select this option, two separate tabs appear in **Page Customizations** for customizing the **Username Email** and **Password Email** notifications.
 - **Send Test Email** to your email address to preview your customization on all devices to ensure that the information appears as it should.
- Step 5** Click **Save** and then **Close**.
-

Customize SMS Text Message Notifications

You can customize the information that is sent via SMS text messages to guests.

Before you begin

- Configure the SMTP server, which is used to send emails to the SMS gateway to deliver the SMS text message. Choose **Administration > System > Settings > SMTP Server**.
- Configure the sponsor groups to support the SMS text notification.
- Set up an account with a third-party SMS gateway. Choose **Administration > Systems > Settings > SMS Gateway**. Cisco ISE sends the text messages as email messages to the gateway, which forwards the messages via the SMS provider to the specified user.
- Ensure that **Enable portal customization with HTML** is enabled by default in **Administration > System > Admin Access > Settings > Portal Customization**.

-
- Step 1** For Self-Registered Guest or Sponsor portals, choose **Work Centers > Guest Access > Portals & Components > Guest or Sponsor Portals > Edit > Portal Page Customization > SMS Receipt or SMS Notification**.
- Step 2** Use the mini-editor and HTML tags to customize the **Message Text**. Use predefined variables to specify the guest account information to be included in the SMS text message.
- Step 3** Under **Settings**, you can:

- **Send username and password separately** in different text messages. If you select this option, two separate tabs appear in **Page Customizations** for customizing the **Username Message** and **Password Message** notifications.
- **Send Test Message** to a cell phone to preview your customization to ensure that the information appears as it should. The supported phone number formats include: +1 ###-###-####, ###-###-####, (###) ###-####, #####, 1##### and so on.

Step 4 Click **Save** and then **Close**.

Customize Print Notifications

You can customize the information that is printed for guests.



Note Within each portal, the print notification logo is inherited from the email notification logo setting.

Before you begin

Ensure that **Enable portal customization with HTML** is enabled by default in **Administration > System > Admin Access > Settings > Portal Customization**.

- Step 1** For Self-Registered Guest and Sponsor portals, choose **Work Centers > Guest Access > Portals & Components > Guest or Sponsor Portals > Edit > Portal Page Customization > Print Receipt or Print Notification**.
- Step 2** Specify the **Print Introduction Text**. Use predefined variables to specify the guest account information to be included in the email message. Use the mini-editor and HTML tags to customize the text.
- Step 3** Preview your customization in the thumbnail or click **Print Preview**. You cannot view any HTML customization in the thumbnail. If you select the **Print Preview** option, a window appears from which you can print the account details to ensure that the information appears as it should.
- Step 4** Click **Save** and then **Close**.
-

Customize Approval Request Email Notifications

You can require sponsors to approve self-registering guests before their accounts are created and before they can obtain their login credentials. You can customize the information that is sent via email to sponsors requesting their approval. This notification only displays if you have specified that self-registering guests using the Self-Registered Guest portals require approval before they are granted network access.

Before you begin

- Configure the SMTP server to enable email notifications. Choose **Administration > Systems > Settings > SMTP Server**.
- Configure support for email notifications to guests. Choose **Work Centers > Guest Access > Settings > Guest Email Settings**. Check **Enable email notifications to guests**.

- If you want a sponsor to approve self-registered account requests, check **Require self-registered guests to be approved** under **Self-Registration Page Settings** on the **Portal Behavior and Flow Settings** tab. That enables the **Approval Request Email** tab under **Notifications** in **Portal Page Customization**, where you can customize the email that goes to the sponsor.

-
- Step 1** Choose **Work Centers > Guest Access > Portals & Components > Configure > Self-Registered Guest Portals > Edit > Portal Page Customization > Approval Request Email**. Here you can:
- Step 2** Do the following:
- Change the default **Logo** that is specified under **Global Page Customizations**.
 - Specify the **Subject** and **Email body**. Use predefined variables to specify the guest account information to be included in the email message. Use the mini-editor and HTML tags to customize the text. For example, to include a link to the Sponsor portal in the request approval email, click **Create a Link** and add the FQDN to the Sponsor portal.
 - Preview your customization on all devices using **Send Test Email** to ensure that it appears as it should.
 - Click **Save** and then **Close**.
- Step 3** Customize the content of the approval email sent by the sponsor:
- Choose **Work Centers > Guest Access > Portals & Components > Sponsor Portals**.
 - Click **Portal Page Customization**.
 - Click the **Email Notification** tab and enter the required details.
-

Edit Error Messages

You can fully customize the error messages that appear on the Failure pages displayed for guests, sponsors and employees. Failure pages are available with all end-user web portals, except the Blacklist portal.

-
- Step 1** Do one of the following:
- For Guest portals, choose **Work Centers > Guest Access > Portals & Components > Guest Portals > Edit > Portal Page Customizations > Messages > Error Messages**.
 - For Sponsor Portals, choose **Work Centers > Guest Access > Portals & Components > Sponsor Portals > Edit > Portal Page Customizations > Messages > Error Messages**.
 - For Device portals, choose **Administration > Device Portals Management > (any portals) > Edit > Portal Page Customizations > Messages > Error Messages**.
- Step 2** From the **View In** drop-down list, choose the language in which you want to view the text while customizing the messages. The drop-down list includes all the languages in the language file associated with a specific portal. Make sure that you update any changes made while customizing the portal page into the supported languages properties files.
- Step 3** Update the error message text. You can search for specific error messages by typing in keywords such as **aup** to find AUP related error messages.
- Step 4** Click **Save** and **Close**.
-



PART **V**

Enable and Configure Cisco ISE Services

- [Set Up Policy Conditions, on page 547](#)
- [Manage Authentication Policies, on page 561](#)
- [Manage Authorization Policies and Profiles, on page 597](#)
- [Configure Threat Centric NAC Service, on page 613](#)
- [Configure Smart Licensing and Smart Call Home Services, on page 631](#)
- [Cisco ISE Endpoint Profiling Policies, on page 633](#)
- [Configure Client Provisioning, on page 707](#)
- [Configure Client Posture Policies, on page 757](#)
- [Cisco TrustSec Policies Configuration, on page 793](#)



CHAPTER 19

Set Up Policy Conditions

- [Policy Conditions, on page 547](#)
- [Simple and Compound Conditions, on page 547](#)
- [Policy Evaluation, on page 548](#)
- [Create Simple Conditions, on page 548](#)
- [Create Compound Conditions, on page 549](#)
- [Profiler Conditions, on page 550](#)
- [Posture Conditions, on page 551](#)
- [Create Patch Management Conditions, on page 555](#)
- [Create Disk Encryption Conditions, on page 556](#)
- [Network Conditions, on page 556](#)
- [Create Time and Date Conditions, on page 558](#)

Policy Conditions

Cisco ISE is a policy-based, network-access-control solution, which offers the following services: network-access, guest, posture, client provisioning, and profiler services. While configuring Cisco ISE, you create authentication, authorization, guest, posture, and profiler policies. Policy conditions are basic building blocks of policies. There are two types of policy conditions, simple and compound.

This chapter describes the policy conditions and how you can create them for the various services that Cisco ISE offers.

Simple and Compound Conditions

Cisco ISE uses rule-based policies to provide network access, profiler, posture, and guest services. These rule-based policies consist of rules that are made up of conditions. Cisco ISE allows you to create conditions as individual, reusable policy elements that can be referred from other rule-based policies. There are two types of conditions:

- **Simple condition**—A simple condition consists of an operand (attribute), an operator (equal to, not equal to, greater than, and so on), and a value. You can save simple conditions and use them in other rule-based policies.

Simple condition takes the form: A operand B, where A can be any attribute from the Cisco ISE dictionary and B can be one of the values that the attribute A can take. The Device Type is used as an attribute for

all network devices that can include all device types as its value, which means that A Equals B in the following form:

DEVICE:Device Type Equals All Device Types

- Compound condition—A compound condition is made up of one or more simple conditions that are connected by the AND or OR operator. Compound conditions are built on top of simple conditions. You can save and reuse compound conditions in other rule-based policies.

Compound condition can take any one of the following forms:

- (X operand Y) AND (A operand B) AND (X operand Z) AND so on
- (X operand Y) OR (A operand B) OR (X operand Z) OR so on

where X and A are attributes from the Cisco ISE dictionary such as the username and device type.

This is an example of a compound condition:

DEVICE:Model Name Matches Catalyst6K AND Network Access:Use Case Equals Host Lookup.

You cannot delete conditions that are used in a policy or are part of a compound condition.

Policy Evaluation

Policies consist of rules, where each rule consists of conditions to be satisfied that allow actions to be performed such as access to network resources. Rule-based conditions form the basis of policies, the sets of rules used when evaluating requests.

At run-time, Cisco ISE evaluates the policy conditions and then applies the result that you define based on whether the policy evaluation returns a true or a false value.

During policy-condition evaluation, Cisco ISE compares an attribute with a value. It is possible that where the attribute specified in the policy condition may not have a value assigned in the request. In such cases, if the operator that is used for comparison is “not equal to,” then the condition will evaluate to true. In all other cases, the condition will evaluate to false.

For example, in the condition Radius.Calling_Station_ID Not Equal to 1.1.1.1, if the Calling Station ID is not present in the RADIUS request, then this condition will evaluate to true. This evaluation is not unique to the RADIUS dictionary and occurs because of the usage of the “Not Equal to” operator.

In Cisco ISE, the **Policy > Policy Sets** table provides a list of all policy sets currently configured in the system. The order of the enabled policy sets determines the order by which the system searches for the relevant policy set every time an endpoint requests access. The last row in the **Policy** page is the default policy that will be applied if none of the rules match the request in any of the other configured policy sets. You can edit the allowed protocols and identity source selection in default policy set, but you cannot delete it.

Create Simple Conditions

You can create simple conditions and reuse them when you define authentication, authorization, or guest policies.

Before you begin

To perform the following task, you must be a Super Admin or Policy Admin.

-
- Step 1** Choose **Policy > Policy Elements > Conditions**.
- Step 2** Click the arrow next to **Authentication** or **Authorization** or **Guest**, and then click **Simple Conditions**.
- Step 3** Click **Add**.
- Step 4** Enter appropriate values for the Name, Description, Attribute, Operator, and Value fields.
- If you specify any Identity Group in simple conditions, ensure that you represented them in FQDN form, like the following:
(InternalUser:IdentityGroup) : Equal : (UserIdentityGroups: Identity Group Name)
- Cisco ISE will not accurately resolve Identity Group entries in the following form: (InternalUser:IdentityGroup) : Equal : (Identity Group Name).
- Step 5** Click **Submit** to save the condition.
-

Related Topics

- [Policy Evaluation](#), on page 548
- [Simple and Compound Conditions](#), on page 547

Create Compound Conditions

You can create compound conditions and reuse them when you define authentication policies.

Before you begin

- Cisco ISE includes predefined compound conditions for some of the most common use cases. You can edit these predefined conditions to suit your requirements.
- To perform the following task, you must be a Super Admin or Policy Admin.

-
- Step 1** Choose **Policy > Policy Elements > Conditions**.
- Step 2** Click the arrow next to **Authentication** or **Authorization** or **Guest** and then click **Compound Conditions**.
- Step 3** Click **Add**.
- Step 4** Enter a name for the compound condition. You can enter an optional description.
- Step 5** Click **Select Existing Condition from Library** to choose an existing simple condition or click **Create New Condition** to choose an attribute, operator, and value from the expression builder.
- Step 6** Click the action icon at the end of this row to add more conditions.
- Step 7** Click **Add Attribute/Value** to create a new condition or click **Add Condition from Library** to add an existing simple condition.
- Step 8** Select operand from the drop-down list. You can choose AND or OR and the same operand will be used between all the conditions in this compound condition.
- Step 9** Click **Submit** to create the compound condition.
-

Related Topics

[Policy Evaluation](#), on page 548

[Simple and Compound Conditions](#), on page 547

Profiler Conditions

Profiling conditions are policy elements and are similar to other conditions. However unlike authentication, authorization, and guest conditions, the profiling conditions can be based on a limited number of attributes. The Profiler Conditions page lists the attributes that are available in Cisco ISE and their description.

Profiler conditions can be one of the following:

- **Cisco Provided:** Cisco ISE includes predefined profiling conditions when deployed and they are identified as Cisco Provided in the Profiler Conditions window. You cannot delete Cisco Provided profiling conditions.

You can also find Cisco Provided conditions in the System profiler dictionaries in the following location: **Policy > Policy Elements > Dictionaries > System**.

For example, MAC dictionary. For some products, the OUI (Organizationally Unique Identifier) is an unique attribute that you can use it first for identifying the manufacturing organization of devices. It is a component of the device MAC address. The MAC dictionary contains the MACAddress and OUI attributes.

- **Administrator Created:** Profiler conditions that you create as an administrator of Cisco ISE or predefined profiling conditions that are duplicated are identified as Administrator Created. You can create a profiler condition of DHCP, MAC, SNMP, IP, RADIUS, NetFlow, CDP, LLDP, and NMAP types using the profiler dictionaries in the **Profiler Conditions** window.

Although, the recommended upper limit for the number of profiling policies is 1000, you can stretch up to 2000 profiling policies.

Create a Profiler Condition

Endpoint profiling policies in Cisco ISE allow you to categorize discovered endpoints on your network, and assign them to specific endpoint identity groups. These endpoint profiling policies are made up of profiling conditions that Cisco ISE evaluates to categorize and group endpoints.

Before you begin

To perform the following task, you must be a Super Admin or Policy Admin.

-
- Step 1** Choose **Policy > Policy Elements > Conditions > Profiling > Add**.
- Step 2** Enter values for the fields as described in the [Endpoint Profiling Policies Settings, on page 1087](#).
- Step 3** Click **Submit** to save the profiler condition.
- Step 4** Repeat this procedure to create more conditions.
-

Related Topics

[Profiler Conditions](#), on page 550

Posture Conditions

A posture condition can be any one of the following simple conditions: a file, a registry, an application, a service, or a dictionary condition. One or more conditions from these simple conditions form a compound condition, which can be associated to a posture requirement.

When you deploy Cisco ISE on your network for the first time, you can download posture updates from the web. This process is called the initial posture update.

After an initial posture update, Cisco ISE also creates Cisco defined simple and compound conditions. Cisco defined simple conditions have pc_ as their prefixes and compound conditions have pr_ as their prefixes.

You can also configure Cisco ISE to download the Cisco-defined conditions periodically as a result of dynamic posture updates through the web. You cannot delete or edit Cisco defined posture conditions.

A user defined condition or a Cisco defined condition includes both simple conditions and compound conditions.

Simple Posture Conditions

You can use the **Posture Navigation** pane to manage the following simple conditions:

- **File Conditions:** A condition that checks the existence of a file, the date of a file, and the versions of a file on the client.
- **Registry Conditions:** A condition that checks for the existence of a registry key or the value of the registry key on the client.
- **Application Conditions:** A condition that checks if an application or process is running or not running on the client.



Note If a process is installed and running, user is compliant. However, the Application condition works in reverse logic; If an application is not installed and not running, the end user is compliant. If an application is installed and running, the end user is non-complaint.

- **Service Conditions:** A condition that checks if a service is running or not running on the client.
- **Dictionary Conditions:** A condition that checks a dictionary attribute with a value.
- **USB Conditions:** A condition that checks for the presence of USB mass storage device.

Related Topics

- [File Condition Settings](#), on page 1094
- [Registry Condition Settings](#), on page 1099
- [Application Condition Settings](#), on page 1100
- [Service Condition Settings](#), on page 1103
- [Dictionary Simple Condition Settings](#), on page 1110
- [USB Condition Settings](#), on page 1115

Create Simple Posture Conditions

You can create file, registry, application, service, and dictionary simple conditions that can be used in posture policies or in other compound conditions.

Before you begin

To perform the following task, you must be a Super Admin or Policy Admin.

-
- Step 1** Choose **Policy > Policy Elements > Conditions > Posture**.
 - Step 2** Choose any one of the following: **File, Registry, Application, Service, or Dictionary Simple Condition**.
 - Step 3** Click **Add**.
 - Step 4** Enter the appropriate values in the fields.
 - Step 5** Click **Submit**.
-

Compound Posture Conditions

Compound conditions are made up of one or more simple conditions, or compound conditions. You can make use of the following compound conditions while defining a Posture policy.

- Compound Conditions: Contains one or more simple conditions, or compound conditions of the type File, Registry, Application, or Service condition
- Antivirus Compound Conditions: Contains one or more AV conditions, or AV compound conditions
- Antispyware Compound Conditions: Contains one or more AS conditions, or AS compound conditions
- Dictionary Compound Conditions: Contains one or more dictionary simple conditions or dictionary compound conditions
- Antimalware Conditions: Contains one or more AM conditions.

Predefined Condition for Enabling Automatic Updates in Windows Clients

The pr_AutoUpdateCheck_Rule is a Cisco predefined condition, which is downloaded to the Compound Conditions window. This condition allows you to check whether the automatic updates feature is enabled on Windows clients. If a Windows client fails to meet this requirement, then the Network Access Control (NAC) Agents enforce the Windows client to enable (remediate) the automatic updates feature. After this remediation is done, the Windows client becomes posture compliant. The Windows update remediation that you associate in the posture policy overrides the Windows administrator setting, if the automatic updates feature is not enabled on the Windows client.

Preconfigured Antivirus and Antispyware Conditions

Cisco ISE loads preconfigured antivirus and antispyware compound conditions in the AV and AS Compound Condition windows, which are defined in the antivirus and antispyware support charts for Windows and Macintosh operating systems. These compound conditions can check if the specified antivirus and antispyware products exist on all the clients. You can also create new antivirus and antispyware compound conditions in Cisco ISE.

Antivirus and Antispyware Support Chart

Cisco ISE uses an antivirus and antispyware support chart, which provides the latest version and date in the definition files for each vendor product. Users must frequently poll antivirus and antispyware support charts for updates. The antivirus and antispyware vendors frequently update antivirus and antispyware definition files, look for the latest version and date in the definition files for each vendor product.

Each time the antivirus and antispyware support chart is updated to reflect support for new antivirus and antispyware vendors, products, and their releases, the agents receive a new antivirus and antispyware library. It helps the Agents to support newer additions. Once the agents retrieve this support information, they check the latest definition information from the periodically updated se-checks.xml file (which is published along with the se-rules.xml file in the se-templates.tar.gz archive), and determine whether clients are compliant with the posture policies. Depending upon what is supported by the antivirus and antispyware library for a particular antivirus, or antispyware product, the appropriate requirements will be sent to the agents for validating their existence, and the status of particular antivirus and antispyware products on the clients during posture validation.

For more information on the antivirus and anti-malware products supported by the ISE posture agent, see the Cisco AnyConnect ISE Posture Support Charts: [Cisco ISE Compatibility Guide](#).

You can verify the minimum compliance module version while creating an anti-malware posture condition. After the posture feed is updated, choose **Work Centers > Posture > Policy Elements > Anti-Malware Condition** and then choose the **Operating System** and **Vendor** to view the support chart.



Note Some of the Anti-Malware endpoint security solutions (such as FireEye, Cisco AMP, Sophos, and so on) require network access to their respective centralized service for functioning. For such products, AnyConnect ISE posture module (or OESIS library) expects the endpoints to have internet connectivity. It is recommended that internet access is allowed for such endpoints during pre-posture for these online agents (if offline detection is not enabled). Signature Definition condition might not be applicable in such cases.

Compliance Module

The compliance module contains a list of fields, such as vendor name, product version, product name, and attributes provided by OPSWAT that supports Cisco ISE posture conditions.

Vendors frequently update the product version and date in the definition files, therefore, you must look for the latest version and date in the definition files for each vendor product by frequently polling the compliance module for updates. Each time the compliance module is updated to reflect the support for new vendors, products, and their releases, the AnyConnect agent receives a new library. It helps the AnyConnect agent to support newer additions. The AnyConnect agent retrieves this support information and checks the latest definition information from the periodically updated se-checks.xml file (which is published along with the se-rules.xml file in the se-templates.tar.gz archive), and determine whether clients are compliant with the posture policies. Depending upon what is supported by the library for a particular antivirus, antispyware, antimalware, disk encryption, or patch management product, the appropriate requirements will be sent to the AnyConnect agent for validating their existence, and the status of the particular products on the clients during posture validation.

The compliance module is available on [Cisco.com](#).

Table given below lists the OPSWAT API versions that support and do not support the ISE posture policy. There are different policy rules for agents that support versions 3 and 4.

Table 39: OPSWAT API Versions

Posture Condition	Compliance Module Version
OPSWAT	
Antivirus	3.x or earlier
Antispyware	3.x or earlier
Antimalware	4.x or later
Disk Encryption	3.x or earlier and 4.x or later
Patch Management	3.x or earlier and 4.x or later
USB	4.x or later
Non-OPSWAT	
File	Any version
Application	Any version
Compound	Any version
Registry	Any version
Service	Any version

**Note**

- Be sure to create separate posture policies for version 3.x or earlier and version 4.x or later, in anticipation of clients that may have installed any one of the above versions.
- OESIS version 4 support is provided for compliance module 4.x and Cisco AnyConnect 4.3 and higher. However, AnyConnect 4.3 supports both OESIS version 3 and version 4 policies.
- Version 4 compliance module is supported by ISE 2.1 and higher.

Create Compound Posture Conditions

You can create compound conditions that can be used in posture policies for posture assessment and validation.

Before you begin

To perform the following task, you must be a Super Admin or Policy Admin.

-
- Step 1** Choose **Policy** > **Policy Elements** > **Conditions** > **Posture** > **Compound Conditions** > **Add**.
- Step 2** Enter appropriate values for the fields.
- Step 3** Click **Validate Expression** to validate the condition.

Step 4 Click **Submit**.

Related Topics

[Posture Conditions](#), on page 551

[Simple Posture Conditions](#), on page 551

[Compound Posture Conditions](#), on page 552

[Predefined Condition for Enabling Automatic Updates in Windows Clients](#), on page 552

[Preconfigured Antivirus and Antispyware Conditions](#), on page 552

Create Patch Management Conditions

You can create a policy to check the status of a selected vendor's patch management product.

For example, you can create a condition to check if Microsoft System Center Configuration Manager (SCCM), Client Version 4.x software product is installed at an endpoint.



Note Supported versions of Cisco ISE and AnyConnect:

- Cisco ISE version 1.4 and later
 - AnyConnect version 4.1 and later
-

Before you begin

To perform the following task, you must be a Super Admin or Policy Admin.

- Step 1** Choose **Policy > Policy Elements > Conditions > Posture > Patch Management Condition**.
- Step 2** Click **Add**.
- Step 3** Enter the condition name and description in the **Name** and **Description** fields.
- Step 4** Choose the appropriate operating system from the **Operating System** drop-down field.
- Step 5** Choose the **Compliance Module** from the drop-down list.
- Step 6** Choose the **Vendor Name** from the drop-down list.
- Step 7** Choose the **Check Type**.
- Step 8** Choose the appropriate patch from the **Check patches installed** drop-down list.
- Step 9** Click **Submit**.
-

Related Topics

[Patch Management Condition Settings](#), on page 1112

[Add a Patch Management Remediation](#), on page 778

Create Disk Encryption Conditions

You can create a policy to check if an end point is compliant with the specified data encryption software.

For example, you can create a condition to check if the C: drive is encrypted in an end point. If the C: drive is not encrypted then the end point receives a non-compliance notification and ISE logs a message.

Before you begin

To perform the following task, you must be a Super Admin or Policy Admin. You can associate a Disk Encryption condition with a posture requirement only when you use the AnyConnect ISE posture agent.

-
- Step 1** Choose **Policy > Policy Elements > Conditions > Posture > Disk Encryption Condition**.
 - Step 2** Click **Add**.
 - Step 3** In the **Disk Encryption Condition** window, enter the appropriate values in the fields.
 - Step 4** Click **Submit**.
-

Network Conditions

A policy is a set of conditions and a result. A policy condition consists of an operand (attribute), an operator (equal to, not equal to, greater than, and so on), and a value. Compound conditions are made up of one or more simple conditions that are connected by the AND or OR operator. At runtime, Cisco ISE evaluates a policy condition and then applies the result that you have defined based on whether the policy evaluation returns a true or a false value.

Each network condition defines a list of objects that can be included in policy conditions, resulting in a set of definitions that are matched against those presented in the request.

You can use the operator, `EQUALS true`, to check if the network condition evaluates to true (whether the value presented in the request matches at least one entry within the network condition) or `EQUALS false` to test whether the network condition evaluates to false (does not match any entry in the network condition).

After you create a network condition with a name, you can reuse this condition multiple times across various rules and policies by selecting the network condition from the Network Conditions dictionary, for example:

```
Network Conditions.MyNetworkCondition EQUALS true
```

You can create the following network conditions to restrict access to the network:

- Endstation Network Conditions—Based on endstations that initiate and terminate the connection.

Cisco ISE evaluates the remote address TO field (which is obtained based on whether it is a TACACS+ or RADIUS request) to identify whether it is the IP address, MAC address, calling line identification (CLI), or dialed number identification service (DNIS) of the endpoint.

In a RADIUS request, this identifier is available in Attribute 31 (Calling-Station-Id).

In a TACACS+ request, if the remote address includes a slash (/), the part before the slash is taken as the FROM value and the part after the slash is taken as the TO value. For example, if a request has

CLI/DNIS, CLI is taken as the FROM value and DNIS is taken as the TO value. If a slash is not included, the entire remote address is taken as the FROM value (whether IP address, MAC address, or CLI).

- **Device Network Conditions**—Based on the AAA client that processes the request.

A network device can be identified by its IP address, device name that is defined in the network device repository, or Network Device Group.

In a RADIUS request, if Attribute 4 (NAS-IP-Address) is present, Cisco ISE obtains the IP address from this attribute. If Attribute 32 (NAS-Identifier) is present, Cisco ISE obtains the IP address from Attribute 32. If these attributes are not found, it obtains the IP address from the packet that it receives.

The device dictionary (NDG dictionary) contains network device group attributes such as Location, Device Type, or other dynamically created attributes that represent NDGs. These attributes contain the groups that the current device is related to.

- **Device Port Network Conditions**—Based on the device's IP address, name, NDG, and port (physical port of the device that the endstation is connected to).

In a RADIUS request, if Attribute 5 (NAS-Port) is present in the request, Cisco ISE obtains the value from this attribute. If Attribute 87 (NAS-Port-Id) is present in the request, Cisco ISE obtains the request from Attribute 87.

In a TACACS+ request, Cisco ISE obtains this identifier from the port field of the start request (of every phase).

Configure Endstation Network Conditions

Step 1 Choose **Policy > Policy Elements > Conditions > Network Conditions > Endstation Network Conditions**.

Step 2 Click **Add**.

Step 3 Enter a name and description for the network condition.

Step 4 Enter the following details:

- **IP Addresses**—You can add a list of IP addresses or subnets, one per line. The IP address/subnet can be in IPv4 or IPv6 format.
- **MAC Addresses**—You can enter a list of Endstation MAC addresses and Destination MAC addresses, separated by a comma. Each MAC address must include 12 hexadecimal digits and must be in one of the following formats: nn.nn.nn.nn.nn.nn, nn-nn-nn-nn-nn-nn, nnnn.nnnn.nnnn, or nnnnnnnnnnnn.
If the Endstation MAC or the Destination MAC is not required, use the token "-ANY-" instead.
- **CLI/DNIS**—You can add a list of Caller IDs (CLI) and Called IDs (DNIS), separated by a comma. If the Caller ID (CLI) or the Called ID (DNIS) is not required, use the token "-ANY-" instead.

Step 5 Click **Submit**.

Configure Device Network Conditions

- Step 1** Choose **Policy > Policy Elements > Conditions > Network Conditions > Device Network Conditions**.
- Step 2** Click **Add**.
- Step 3** Enter a name and description for the network condition.
- Step 4** Enter the following details:
- **IP Addresses**—You can add a list of IP addresses or subnets, one per line. The IP address/subnet can be in IPv4 or IPv6 format.
 - **Device Name**—You can add a list of device names, one per line. You must enter the same device name that is configured in the Network Device object.
 - **Device Groups**—You can add a list of tuples in the following order: Root NDG, comma, and an NDG (that it under the root NDG). There must be one tuple per line.
- Step 5** Click **Submit**.
-

Configure Device Port Network Condition

- Step 1** Choose **Policy > Policy Elements > Conditions > Network Conditions > Device Port Network Conditions**.
- Step 2** Click **Add**.
- Step 3** Enter a name and description for the network condition.
- Step 4** Enter the following details:
- **IP Addresses**—Enter the details in the following order: IP address or subnet, comma, and a port (that is used by the device). There must be one tuple per line.
 - **Devices**— Enter the details in the following order: device name, comma, and a port. There must be one tuple per line. You must enter the same device name that is configured in the Network Device object.
 - **Device Groups**— Enter the details in the following order: Root NDG, comma, NDG (that it under the root), and a port. There must be one tuple per line.
- Step 5** Click **Submit**.
-

Create Time and Date Conditions

Use the Policy Elements Conditions page to display, create, modify, delete, duplicate, and search time and date policy element conditions. Policy elements are shared objects that define a condition that is based on specific time and date attribute settings that you configure.

Time and date conditions let you set or limit permission to access Cisco ISE system resources to specific times and days as directed by the attribute settings you make.

Before you begin

To perform the following task, you must be a Super Admin or Policy Admin.

Step 1 Choose **Policy > Policy Elements > Conditions > Time and Date > Add**.

Step 2 Enter appropriate values in the fields.

- In the Standard Settings area, specify the time and date to provide access.
- In the Exceptions area, specify the time and date range to limit access.

Step 3 Click **Submit**.



CHAPTER 20

Manage Authentication Policies

- [Cisco ISE Authentication Policies](#), on page 561
- [Simple Authentication Policies](#), on page 564
- [Rule-Based Authentication Policies](#), on page 566
- [Protocol Settings for Authentication](#), on page 571
- [Network Access Service](#), on page 575
- [Network Access Work Center](#), on page 579
- [Cisco ISE Acting as a RADIUS Proxy Server](#), on page 579
- [Cisco ISE Acting as a TACACS+ Proxy Client](#), on page 581
- [Location Based Authorization](#), on page 585
- [Policy Modes](#), on page 586
- [Configure a Simple Authentication Policy](#), on page 587
- [Configure a Rule-Based Authentication Policy](#), on page 588
- [Policy Sets](#), on page 590
- [Authentication Policy Built-In Configurations](#), on page 592
- [View Authentication Results](#), on page 595

Cisco ISE Authentication Policies

Authentication policies define the protocols that Cisco ISE uses to communicate with the network devices, and the identity sources that it uses for authentication. A policy is a set of conditions and a result. A policy condition consists of an operand (attribute), an operator (equal to, not equal to, greater than, and so on), and a value. Compound conditions are made up of one or more simple conditions that are connected by the AND or OR operator. At runtime, Cisco ISE evaluates a policy condition and then applies the result that you have defined based on whether the policy evaluation returns a true or a false value.

An authentication policy consists of the following:

- Network Access Service—This service can be one of the following:
 - An allowed protocols service to choose the protocols to handle the initial request and protocol negotiation.
 - A proxy service that will proxy requests to an external RADIUS server for processing.
- Identity Source—An identity source or an identity source sequence to be used for authentication.

After installation, a default identity authentication policy is available in Cisco ISE that is used for authentications. Any updates to the authentication policy will override the default settings.

Related Topics

- [Policy Condition Evaluation](#), on page 562
- [Supported Authentication Protocols](#), on page 562
- [Supported Authentication Types and Database](#), on page 562
- [Types of Authentication Failures—Failovers](#), on page 563
- [Authentication Policy Terminology](#), on page 564

Policy Condition Evaluation

During policy condition evaluation, Cisco ISE compares an attribute with a value. It is possible to run into a situation where the attribute specified in the policy condition may not have a value assigned in the request. In such cases, if the operator that is used for comparison is “not equal to,” then the condition will evaluate to true. In all other cases, the condition will evaluate to false.

For example, for a condition Radius.Calling_Station_ID Not Equal to 1.1.1.1, if the Calling Station ID is not present in the RADIUS request, then this condition will evaluate to true. This evaluation is not unique to the RADIUS dictionary and occurs because of the usage of the “Not Equal to” operator.

Supported Authentication Protocols

The following is a list of protocols that you can choose while defining your authentication policy:

- Password Authentication Protocol (PAP)
- Protected Extensible Authentication Protocol (PEAP)
- Microsoft Challenge Handshake Authentication Protocol Version 2 (MS-CHAPv2)
- Extensible Authentication Protocol-Message Digest 5 (EAP-MD5)
- Extensible Authentication Protocol-Transport Layer Security (EAP-TLS)
- Extensible Authentication Protocol-Flexible Authentication via Secure Tunneling (EAP-FAST)
- Extensible Authentication Protocol-Tunneled Transport Layer Security (EAP-TTLS)
- Protected Extensible Authentication Protocol-Transport Layer Security (PEAP-TLS)

Related Topics

- [Supported Authentication Types and Database](#), on page 562
- [Authentication Policy Terminology](#), on page 564
- [Simple Authentication Policies](#), on page 564
- [Rule-Based Authentication Policies](#), on page 566

Supported Authentication Types and Database

The authentication type is based on the protocols that are chosen. The authentication type is password based, where the authentication is performed against a database with the username and password that is presented in the request.

The identity method, which is the result of the authentication policy, can be any one of the following:

- Deny access—Access to the user is denied and no authentication is performed.
- Identity database—A single identity database that can be any one of the following:
 - Internal users
 - Guest users
 - Internal endpoints
 - Active Directory
 - Lightweight Directory Access Protocol (LDAP) database
 - RADIUS token server (RSA or SafeWord server)
 - Certificate authentication profile
- Identity source sequences—A sequence of identity databases that is used for authentication.

By default, the identity source that Cisco ISE will look up for user information is the internal users database.

Types of Authentication Failures—Failovers

If you choose the identity method as deny access, a reject message is sent as a response to the request. If you choose an identity database or an identity source sequence and the authentication succeeds, the processing continues to the authorization policy. Some of the authentications fail and these are classified as follows:

- Authentication failed—Received explicit response that authentication has failed such as bad credentials, disabled user, and so on. The default course of action is reject.
- User not found—No such user was found in any of the identity databases. The default course of action is reject.
- Process failed—Unable to access the identity database or databases. The default course of action is drop.

Cisco ISE allows you to configure any one of the following courses of action for authentication failures:

- Reject—A reject response is sent.
- Drop—No response is sent.
- Continue—Cisco ISE continues with the authorization policy.

Even when you choose the Continue option, there might be instances where Cisco ISE cannot continue processing the request due to restrictions on the protocol that is being used. For authentications using PEAP, LEAP, EAP-FAST, EAP-TLS, or RADIUS MSCHAP, it is not possible to continue processing the request when authentication fails or user is not found.

When authentication fails, it is possible to continue to process the authorization policy for PAP/ASCII and MAC authentication bypass (MAB or host lookup). For all other authentication protocols, when authentication fails, the following happens:

- Authentication failed—A reject response is sent.
- User or host not found—A reject response is sent.

- Process failure—No response is sent and the request is dropped.

Authentication Policy Terminology

The following are some of the commonly used terms in the authentication policy pages:

- Allowed Protocols—Allowed protocols define the set of protocols that Cisco ISE can use to communicate with the device that requests access to the network resources.
- Identity Source—Identity source defines which database Cisco ISE should use for user information. The database could be an internal database or an external identity source, such as Active Directory or LDAP. You can add a sequence of databases to an identity source sequence and list this sequence as the identity source in your policy. Cisco ISE will search for the credentials in the order in which the databases are listed in this sequence.
- Failover Options—You can define what course of action Cisco ISE should take if the authentication fails, the user is not found, or if the process fails.

Simple Authentication Policies

A simple authentication policy allows you to statically define the allowed protocols and the identity source or identity source sequence that Cisco ISE should use for communication. You cannot define any condition for simple policies. Cisco ISE assumes that all conditions are met and uses the following definitions to determine the result:

- You can create simple policies in situations where you can statically define the allowed protocols and the identity source that must be used always, and no condition needs to be checked.
- You can also create proxy service-based simple policies. Cisco ISE proxies the request to a policy server to determine which identity source should be used for user authentication. If the request is proxied to a different policy server, the protocol negotiation does not happen. The policy server evaluates which identity source should be used for authentication and returns the response to Cisco ISE.

Related Topics

[Simple Authentication Policy Flow](#), on page 565

[Guidelines for Configuring Simple Authentication Policies](#), on page 566

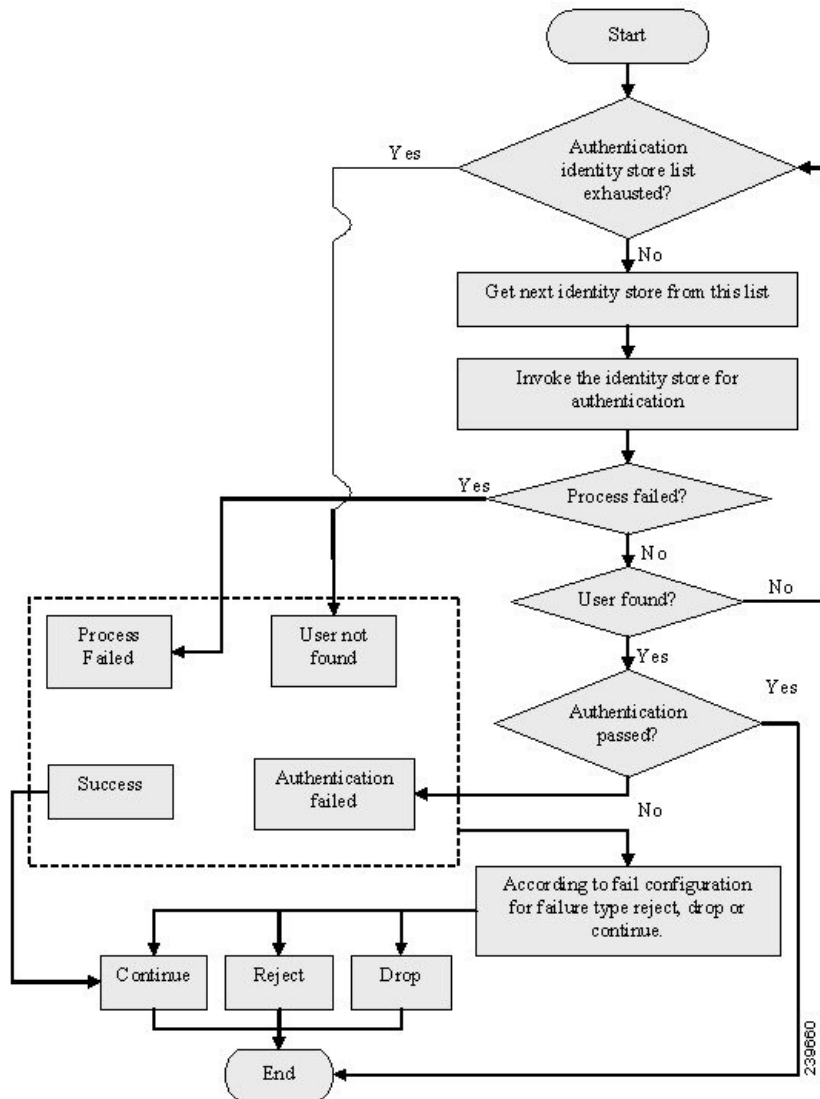
[Define Allowed Protocols for Network Access](#), on page 576

[Configure a Simple Authentication Policy](#), on page 587

[Rule-Based Authentication Policies](#), on page 566

Simple Authentication Policy Flow

Figure 50: Simple Authentication Policy Flow



The result of a simple policy can be any one of the following:

- Authentication passed
- Authentication failed

An authentication can fail happens due to any of the following reasons:

- Bad credentials or disabled user.
- User not found.
- Authentication process fails.

Guidelines for Configuring Simple Authentication Policies

Follow these guidelines when configuring simple authentication policies:

- If you wish to use the RADIUS server sequence, then you must define this access service before you define the policy.
- If your users are defined in external identity sources, ensure that you have configured these identity sources in Cisco ISE before you define the policy.
- If you want to use an identity source sequence for authenticating users, ensure that you have created the identity source sequence before you define the policy.
- When you switch between simple and rule-based authentication policies, you will lose the policy that you configured earlier. For example, if you configured a simple authentication policy and you want to move to a rule-based authentication policy, you will lose the simple authentication policy. Also, when you move from a rule-based authentication policy to a simple authentication policy, you will lose the rule-based authentication policy.
- Host authentication is performed with the MAC address only (MAB).

Related Topics

[Cisco ISE Acting as a RADIUS Proxy Server](#), on page 579

Rule-Based Authentication Policies

Rule-based authentication policies consist of attribute-based conditions that determine the allowed protocols and the identity source or identity source sequence to be used for processing the requests. In a simple authentication policy, you can define the allowed protocols and identity source statically. In a rule-based policy, you can define conditions that allows Cisco ISE to dynamically choose the allowed protocols and identity sources. You can define one or more conditions using any of the attributes from the Cisco ISE dictionary.

Cisco ISE allows you to create conditions as individual, reusable policy elements that can be referred from other rule-based policies. You can also create conditions from within the policy creation page. The two types of conditions are:

- Simple condition
- Compound condition

Related Topics

[Attributes Supported by Dictionaries](#), on page 568

[Configure a Rule-Based Authentication Policy](#), on page 588

Rule-Based Authentication Policy Flow

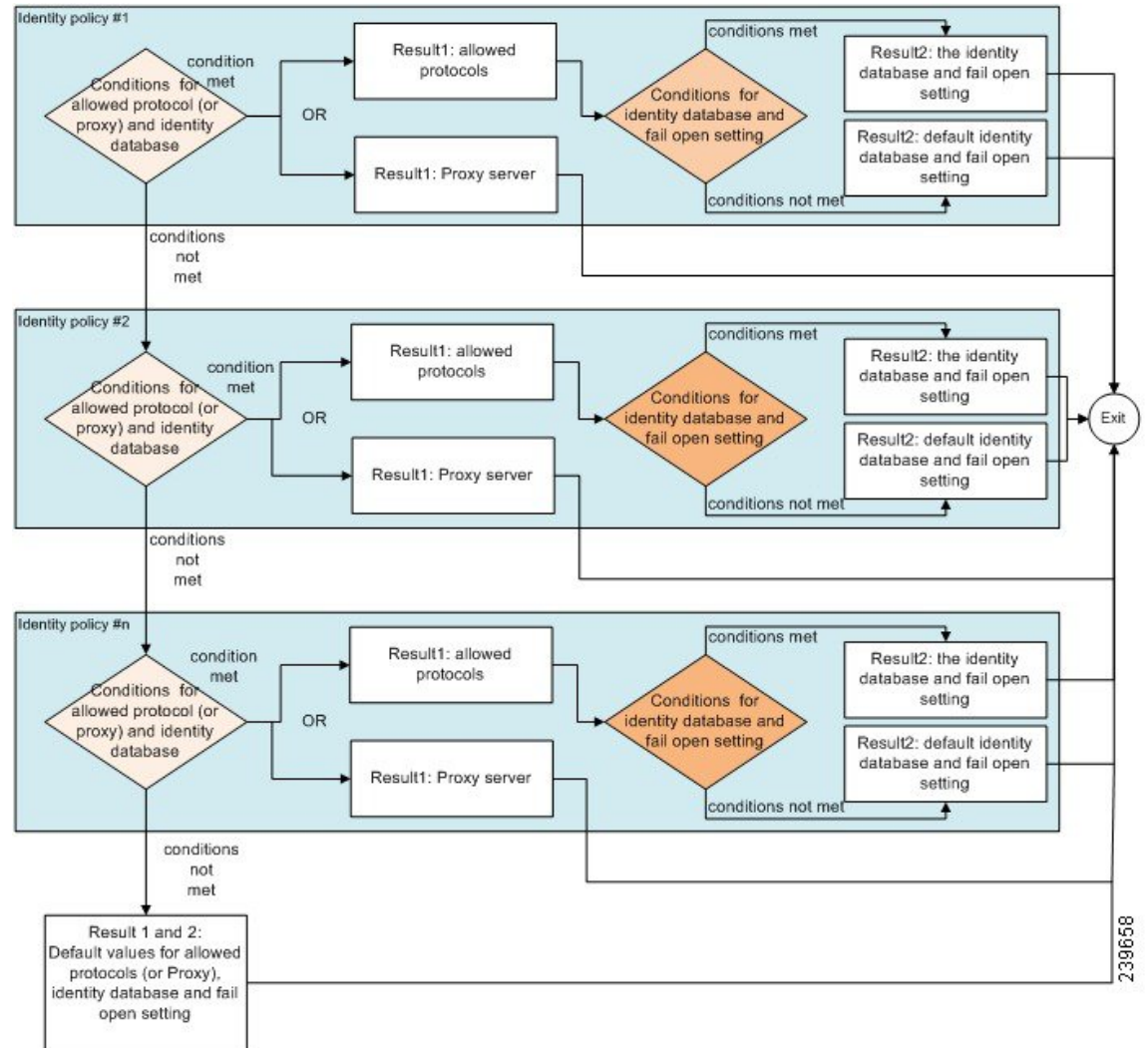
In rule-based policies, you can define multiple rules. The identity database is selected based on the first rule that matches the criteria.

You can also define an identity source sequence consisting of different databases. You can define the order in which you want Cisco ISE to look up these databases. Cisco ISE will access these databases in sequence

until the authentication succeeds. If there are multiple instances of the same user in an external database, the authentication fails. There can only be one user record in an identity source.

We recommend that you use only three, or at most four databases in an identity source sequence.

Figure 51: Rule-Based Authentication Policy Flow



238658

Supported Dictionaries for Rule-Based Authentication Policies

Cisco ISE supports the following dictionaries:

- System-defined dictionaries
 - CERTIFICATE
 - DEVICE
 - RADIUS

- RADIUS vendor dictionaries
 - Airespace
 - Cisco
 - Cisco-BBSM
 - Cisco-VPN3000
 - Microsoft
 - Network access

Attributes Supported by Dictionaries

The table lists the fixed attributes that are supported by dictionaries, which can be used in policy conditions. Not all of these attributes are available for creating all types of conditions.

For example, while creating a condition to choose the access service in authentication policies, you will only see the following network access attributes: Device IP Address, ISE Host Name, Network Device Name, Protocol, and Use Case.

You can use the attributes listed in the following table in policy conditions.

Dictionary	Attributes	Allowed Protocol Rules and Proxy	Identity Rules
Device	Device Type (predefined network device group)	Yes	Yes
	Device Location (predefined network device group)		
	Other Custom Network Device Group		
	Software Version		
	Model Name		
RADIUS	All attributes	Yes	Yes

Dictionary	Attributes	Allowed Protocol Rules and Proxy	Identity Rules
Network Access	ISE Host Name	Yes	Yes
	AuthenticationMethod	No	Yes
	AuthenticationStatus	No	No
	CTSDeviceID	No	No
	Device IP Address	Yes	Yes
	EapAuthentication (the EAP method that is used during authentication of a user of a machine)	No	Yes
	EapTunnel (the EAP method that is used for tunnel establishment)	No	Yes
	Protocol	Yes	Yes
	UseCase	Yes	Yes
	UserName	No	Yes
	WasMachineAuthenticated	No	No

Dictionary	Attributes	Allowed Protocol Rules and Proxy	Identity Rules
Certificate	Common Name	No	Yes
	Country		
	E-mail		
	LocationSubject		
	Organization		
	Organization Unit		
	Serial Number		
	State or Province		
	Subject		
	Subject Alternative Name		
	Subject Alternative Name - DNS		
	Subject Alternative Name - E-mail		
	Subject Alternative Name - Other Name		
	Subject Serial Number		
	Issuer		
	Issuer - Common Name		
	Issuer - Organization		
	Issuer - Organization Unit		
	Issuer - Location		
	Issuer - Country		
	Issuer - Email		
	Issuer - Serial Number		
	Issuer - State or Province		
Issuer - Street Address			
Issuer - Domain Component			
Issuer - User ID			

Protocol Settings for Authentication

You must define global protocol settings in Cisco ISE before you can use these protocols to create, save and implement a policy set to process an authentication request. You can use the Protocol Settings page to define global options for the Extensible Authentication Protocol-Flexible Authentication via Secure Tunneling (EAP-FAST), Extensible Authentication Protocol-Transport Layer Security (EAP-TLS), and Protected Extensible Authentication Protocol (PEAP) protocols, which communicate with the other devices in your network.

Related Topics

[Guidelines for Using EAP-FAST as Authentication Protocol](#), on page 571

[Configure EAP-FAST Settings](#), on page 572

[Generate the PAC for EAP-FAST](#), on page 572

[Configure EAP-TLS Settings](#), on page 573

[Configure PEAP Settings](#), on page 574

[Configure RADIUS Settings](#), on page 574

Guidelines for Using EAP-FAST as Authentication Protocol

Follow these guidelines when using EAP-FAST as an authentication protocol:

- It is highly recommended to enable EAP-TLS inner method when the EAP-FAST accept client certificate is enabled on authenticated provisioning. EAP-FAST accept client certificate on authenticated provisioning is not a separate authentication method but a shorter form of client certificate authentication that uses the same certificate credentials type to authenticate a user but does not require to run an inner method.
- Accept client certificate on authenticated provisioning works with PAC-less full handshake and authenticated PAC provisioning. It does not work for PAC-less session resume, anonymous PAC provisioning, and PAC-based authentication.
- EAP attributes are displayed per identity (so in EAP chaining displayed twice) are shown in authentication details in monitoring tool in order user then machine even if authentication happens in different order.
- When EAP-FAST authorization PAC is used then EAP authentication method shown in live logs is equal to the authentication method used for full authentication (as in PEAP) and not as Lookup.
- In EAP chaining mode when tunnel PAC is expired then ISE falls back to provisioning and AC requests User and Machine authorization PACs - Machine Authorization PAC cannot be provisioned. It will be provisioned in the subsequent PAC-based authentication conversation when AC requests it.
- When Cisco ISE is configured for chaining and AC for single mode then AC response with IdentityType TLV to ISE. However, the second identity authentication fails. You can see from this conversation that client is suitable to perform chaining but currently is configured for single mode.
- Cisco ISE supports retrieval attributes and groups for both machine and user in EAP-FAST chaining only for AD. For LDAP and Internal DB ISE uses only the last identity attributes.



Note “EAP-FAST cryptobinding verification failed” message might be seen if EAP-FAST authentication protocol is used for High Sierra, Mojave, or Catalina MAC OSX devices. We recommend that you configure the Preferred EAP Protocol field in the Allowed Protocols page to use PEAP or EAP-TLS instead of EAP-FAST for these MAC OSX devices.

Configure EAP-FAST Settings

Before you begin

To perform the following task, you must be a Super Admin or System Admin.

-
- Step 1** Choose **Administration** > **System** > **Settings** > **Protocols** > **EAP-FAST** > **EAP Fast Settings**.
 - Step 2** Enter the details as required to define the EAP-FAST protocol.
 - Step 3** Click **Revoke** if you want to revoke all the previously generated primary keys and PACs.
 - Step 4** Click **Save** to save the EAP-FAST settings.
-

Related Topics

[Generate the PAC for EAP-FAST](#), on page 572

Generate the PAC for EAP-FAST

You can use the Generate PAC option in the Cisco ISE to generate a tunnel or machine PAC for the EAP-FAST protocol.

Before you begin

To perform the following task, you must be a Super Admin or System Admin.

-
- Step 1** Choose **Administration** > **System** > **Settings**.
 - Step 2** From the Settings navigation pane on the left, click **Protocols**.
 - Step 3** Choose **EAP-FAST** > **Generate PAC**.
 - Step 4** Enter the details as required to generate machine PAC for the EAP-FAST protocol.
 - Step 5** Click **Generate PAC**.
-

Using EAP-TTLS as Authentication Protocol

EAP-TTLS is a two-phase protocol that extends the functionality of EAP-TLS protocol. Phase 1 builds the secure tunnel and derives the session keys used in Phase 2 to securely tunnel attributes and inner method data between the server and the client. You can use the attributes tunneled during Phase 2 to perform additional authentications using a number of different mechanisms.

Cisco ISE can process authentications from a variety of TTLS supplicants including:

- AnyConnect Network Access Manager (NAM) on Windows
- Windows 8.1 native supplicant
- Secure W2 (also called as JoinNow on MultiOS)
- MAC OS X native supplicant
- IOS native supplicant
- Android based native supplicant
- Linux WPA supplicant



Note If cryptobinding is required, you must use EAP-FAST as the inner method.

Configure EAP-TTLS Settings

Before you begin

To perform the following task, you must be a Super Admin or System Admin.

-
- Step 1** Choose **Administration > System > Settings > Protocols > EAP-TTLS**.
 - Step 2** Enter the required details in the EAP-TTLS Settings page.
 - Step 3** Click **Save**.

Related Topics

[EAP-TTLS Settings](#), on page 999

Configure EAP-TLS Settings

Before you begin

To perform the following task, you must be a Super Admin or System Admin.

-
- Step 1** Choose **Administration > System > Settings > Protocols > EAP-TLS**.
 - Step 2** Enter the details as required to define the EAP-TLS protocol.
 - Step 3** Click **Save** to save the EAP-TLS settings.
-

Configure PEAP Settings

Before you begin

To perform the following task, you must be a Super Admin or System Admin.

-
- Step 1** Choose **Administration > System > Settings**.
 - Step 2** From the Settings navigation pane on the left, click **Protocols**.
 - Step 3** Choose **PEAP**.
 - Step 4** Enter the details as required to define the PEAP protocol.
 - Step 5** Click **Save** to save the PEAP settings.
-

Configure RADIUS Settings

You can configure the RADIUS settings to detect the clients that fail to authenticate and to suppress the repeated reporting of successful authentications.

-
- Step 1** Choose **Administration > System > Settings**.
 - Step 2** From the Settings navigation pane, click **Protocols**.
 - Step 3** Choose **RADIUS**.
 - Step 4** Enter the details as required to define the RADIUS settings.
 - Step 5** Click **Save** to save the settings.
-

Configure Security Settings

To configure the security settings:

-
- Step 1** Choose **Administration > System > Settings > Protocols > Security Settings**.
 - Step 2** In the Security Settings page, select the required options:
 - Allow TLS 1.0 for Legacy Servers—Check this check box to enable TLS 1.0 only for legacy servers. This option is enabled by default.The following workflows are affected by this option:
 - Cisco ISE downloads CRL from HTTPS or secure LDAP server.
 - Cisco ISE is configured as secure syslog client.
 - Cisco ISE is configured as secure LDAP client.

Note It is recommended that servers negotiate to use a higher version of TLS for enhanced security.

- Allow SHA-1 for Legacy Servers—Check this check box to enable SHA-1 cipher suites only for legacy servers. This option is enabled by default.

The following workflows are affected by this option:

- Cisco ISE downloads CRL from HTTPS or secure LDAP server.
- Cisco ISE is configured as secure syslog client.
- Cisco ISE is configured as secure LDAP client.

It is recommended to use SHA-256 or SHA-384 ciphers for enhanced security.

- Allow TLS Renegotiation—Check this check box to allow renegotiation of parameters and generation of new keys. This option is enabled by default.
- Allow 3DES/DES/DSS/RC4 ciphers for ISE secure clients—If this option is enabled, 3DES, DES, DSS, and RC4 ciphers are allowed for communication with peers for the following workflows:
 - Cisco ISE downloads CRL from HTTPS or secure LDAP server.
 - Cisco ISE is configured as secure syslog client.
 - Cisco ISE is configured as secure LDAP client.

This option is enabled by default.

Step 3 Click **Save**.

The following workflow is not affected by the Security Settings:

- Cisco ISE acts as an EAP-TLS, EAP-TTLS, PEAP, or EAP-FAST server that authenticates clients to provide them access to the network.



Note Security Settings page options are changed in Cisco ISE 2.2 patch 2 and above. For more information, see the [Release Notes for the Cisco Identity Services Engine, Release 2.2](#).

Network Access Service

A network access service contains the authentication policy conditions for requests. You can create separate network access services for different use cases, for example, Wired 802.1X, Wired MAB, and so on. To create a network access service, configure allowed protocols or server sequences.

Related Topics

[Define Allowed Protocols for Network Access](#), on page 576

[Cisco ISE Acting as a RADIUS Proxy Server](#), on page 579

[Simple Authentication Policies](#), on page 564

[Configure a Rule-Based Authentication Policy](#), on page 588

Define Allowed Protocols for Network Access

Allowed protocols define the set of protocols that Cisco ISE can use to communicate with the device that requests access to the network resources. An allowed protocols access service is an independent entity that you should create before you configure authentication policies. Allowed protocols access service is an object that contains your chosen protocols for a particular use case.

The Allowed Protocols Services page lists all the allowed protocols services that you create. There is a default network access service that is predefined in the Cisco ISE.

Before you begin

Before you begin this procedure, you should have a basic understanding of the protocol services that are used for authentication.

- Review the Cisco ISE Authentication Policies section in this chapter to understand authentication type and the protocols that are supported by various databases.
- Review the PAC Options to understand the functions and options for each protocol service, so you can make the selections that are appropriate for your network.
- Ensure that you have defined the global protocol settings.

To perform the following task, you must be a Super Admin or System Admin.

Step 1 Choose **Policy > Policy Elements > Results > Authentication > Allowed Protocols**.

If Cisco ISE is set to operate in FIPS mode, some protocols are disabled by default and cannot be configured.

Step 2 Click **Add**.

Step 3 Enter the required information.

Step 4 Select the appropriate authentication protocols and options for your network.

Step 5 If you choose to use PACs, make the appropriate selections.

To enable Anonymous PAC Provisioning, you must choose both the inner methods, EAP-MSCHAPv2 and Extensible Authentication Protocol-Generic Token Card (EAP-GTC). Also, be aware that Cisco ISE only supports Active Directory as an external identity source for machine authentication.

Step 6 Click **Submit** to save the allowed protocols service.

The allowed protocols service appears as an independent object in the simple and rule-based authentication policy pages. You can use this object in different rules.

You can now create a simple or rule-based authentication policy.

If you disable EAP-MSCHAP as inner method and enable EAP-GTC and EAP-TLS inner methods for PEAP or EAP-FAST, ISE starts EAP-GTC inner method during inner method negotiation. Before the first EAP-GTC message is sent to the client, ISE executes identity selection policy to obtain GTC password from the identity store. During the execution of this policy, EAP authentication is equal to EAP-GTC. If EAP-GTC inner method is rejected by the client and EAP-TLS is negotiated, identity store policy is not executed again. In case identity store policy is based on EAP authentication attribute, it might have unexpected results since the real EAP authentication is EAP-TLS but was set after identity policy evaluation.

Related Topics

[Cisco ISE Authentication Policies](#), on page 561

[Protocol Settings for Authentication](#), on page 571

Enable MAB from Non-Cisco Devices

Configure the following settings sequentially to configure MAB from non-Cisco devices.

-
- Step 1** Ensure that the MAC address of the endpoints that are to be authenticated are available in the Endpoints database. You can add these endpoints or have them profiled automatically by the Profiler service.
- Step 2** Create a Network Device Profile based on the type of MAC authentication used by the non-Cisco device (PAP, CHAP, or EAP-MD5).
- Choose **Administration > Network Resources > Network Device Profiles**.
 - Click **Add**.
 - Enter a name and description for the network device profile.
 - Select the vendor name from the **Vendor** drop-down list.
 - Check the check boxes for the protocols that the device supports. If the device supports RADIUS, select the RADIUS dictionary to use with the network device.
 - Expand the **Authentication/Authorization** section to configure the device's default settings for flow types, attribute aliasing, and host lookup.
 - In the **Host Lookup (MAB)** section, do the following:
 - Process Host Lookup—Check this check box to define the protocols for host lookup used by the network device profile.

Network devices from different vendors perform MAB authentication differently. Depending on the device type, check the **Check Password** check box and/or **Check Calling-Station-Id equals MAC Address** check box, for the protocol you are using.
 - Via PAP/ASCII—Check this check box to configure Cisco ISE to detect a PAP request from the network device profile as a Host Lookup request.
 - Via CHAP—Check this check box to configure Cisco ISE to detect this type of request from the network devices as a Host Lookup request.
 - Via EAP-MD5—Check this check box to enable EAP-based MD5 hashed authentication for the network device profile.
 - Enter the required details in the Permissions, Change of Authorization (CoA), and Redirect sections, and then click **Submit**.

For information on how to create custom NAD profiles, see [Network Access Device Profiles with Cisco Identity Services Engine](#).
- Step 3** Choose **Administration > Network Resources > Network Devices**.
- Step 4** Select the device for which you want to enable MAB, and then click **Edit**.
- Step 5** In the Network Device page, select the network device profile that you created in step 2 from the **Device Profile** drop-down list.

Step 6 Click **Save**.



Note For Cisco NADs, the Service-Type values used for MAB and web/user authentication are different. This allows ISE to differentiate MAB from web authentication when Cisco NADs are used. Some non-Cisco NADs use the same value for the Service-Type attribute for both MAB and web/user authentication; this may lead to security issues in your access policies. If you are using MAB with non-Cisco devices, we recommend that you configure additional authorization policy rules to ensure that your network security is not compromised. For example, if a printer is using MAB, you could configure an authorization policy rule to restrict it to printer protocol ports in the ACL.

Related Topics

[Define Allowed Protocols for Network Access](#), on page 576

[Configure a Rule-Based Authentication Policy](#), on page 588

Enable MAB from Cisco Devices

Configure the following settings sequentially to configure MAB from Cisco devices.

- Step 1** Ensure that the MAC address of the endpoints that are to be authenticated are available in the Endpoints database. You can add these endpoints or have them profiled automatically by the Profiler service.
- Step 2** Create a Network Device Profile based on the type of MAC authentication used by the Cisco device (PAP, CHAP, or EAP-MD5).
- Choose **Administration > Network Resources > Network Device Profiles**.
 - Click **Add**.
 - Enter a name and description for the network device profile.
 - Check the check boxes for the protocols that the device supports. If the device supports RADIUS, select the RADIUS dictionary to use with the network device.
 - Expand the **Authentication/Authorization** section to configure the device's default settings for flow types, attribute aliasing, and host lookup.
 - In the **Host Lookup (MAB)** section, do the following:
 - **Process Host Lookup**—Check this check box to define the protocols for host lookup used by the network device profile.

Depending on the device type, check the **Check Password** check box and/or **Check Calling-Station-Id equals MAC Address** check box, for the protocol you are using.
 - **Via PAP/ASCII**—Check this check box to configure Cisco ISE to detect a PAP request from the network device profile as a Host Lookup request.
 - **Via CHAP**—Check this check box to configure Cisco ISE to detect this type of request from the network devices as a Host Lookup request.
 - **Via EAP-MD5**—Check this check box to enable EAP-based MD5 hashed authentication for the network device profile.

- g) Enter the required details in the Permissions, Change of Authorization (CoA), and Redirect sections, and then click **Submit**.

For information on how to create custom NAD profiles, see [Network Access Device Profiles with Cisco Identity Services Engine](#).

Step 3 Choose **Administration > Network Resources > Network Devices**.

Step 4 Select the device for which you want to enable MAB, and then click **Edit**.

Step 5 In the Network Device page, select the network device profile that you created in step 2 from the **Device Profile** drop-down list.

Step 6 Click **Save**.

[ISE Community Resource](#)

For information about IP phone authentication capabilities, see [Phone Authentication Capabilities](#).

Related Topics

- [Define Allowed Protocols for Network Access](#), on page 576
- [Configure a Rule-Based Authentication Policy](#), on page 588

Network Access Work Center

Network Access related options are grouped under **Work Centers > Network Access**, so that the administrator can easily access all the options related to network access at one location.

You can perform the following tasks from the **Network Access** window:

- Configure the external identity stores that you intend to use during the authentication process for users and devices. You can configure the following external identity stores: Active Directory, LDAP, ODBC, RADIUS, RSA, and SAML ID Providers.
- Define policy elements to be used in the authentication and authorization policies.
- Add all the network devices that will be controlled by Cisco ISE. Devices can be grouped by type and location.
- Define authentication and authorization policies for users and network devices based on your requirements.
- Check default network access settings for client provisioning, protocol settings, and proxy configuration.
- Monitor network events by using RADIUS Live logs.
- Run network access reports to check access and authorization results.
- Troubleshoot network access issues using the diagnostic tools.

Cisco ISE Acting as a RADIUS Proxy Server

Cisco ISE can function both as a RADIUS server and as a RADIUS proxy server. When it acts as a proxy server, Cisco ISE receives authentication and accounting requests from the network access server (NAS) and

forwards them to the external RADIUS server. Cisco ISE accepts the results of the requests and returns them to the NAS.

Cisco ISE can simultaneously act as a proxy server to multiple external RADIUS servers. You can use the external RADIUS servers that you configure here in RADIUS server sequences. The External RADIUS Server page lists all the external RADIUS servers that you have defined in Cisco ISE. You can use the filter option to search for specific RADIUS servers based on the name or description, or both. In both simple and rule-based authentication policies, you can use the RADIUS server sequences to proxy the requests to a RADIUS server.

The RADIUS server sequence strips the domain name from the RADIUS-Username attribute for RADIUS authentications. This domain stripping is not applicable for EAP authentications, which use the EAP-Identity attribute. The RADIUS proxy server obtains the username from the RADIUS-Username attribute and strips it from the character that you specify when you configure the RADIUS server sequence. For EAP authentications, the RADIUS proxy server obtains the username from the EAP-Identity attribute. EAP authentications that use the RADIUS server sequence will succeed only if the EAP-Identity and RADIUS-Username values are the same.

Configure External RADIUS Servers

You must configure the external RADIUS servers in the Cisco ISE to enable it to forward requests to the external RADIUS servers. You can define the timeout period and the number of connection attempts.

Before you begin

- You cannot use the external RADIUS servers that you create in this section by themselves. You must create a RADIUS server sequence and configure it to use the RADIUS server that you create in this section. You can then use the RADIUS server sequence in authentication policies.
- To perform the following task, you must be a Super Admin or System Admin.

Step 1 Choose **Administration** > **Network Resources** > **External RADIUS Servers**.

The RADIUS Servers page appears with a list of external RADIUS servers that are defined in Cisco ISE.

Step 2 Click **Add** to add an external RADIUS server.

Step 3 Enter the values as required.

Step 4 Click **Submit** to save the external RADIUS server configuration.

Related Topics

[RADIUS Server Sequence](#)

Define RADIUS Server Sequences

RADIUS server sequences in Cisco ISE allow you to proxy requests from a NAD to an external RADIUS server that will process the request and return the result to Cisco ISE, which forwards the response to the NAD.

RADIUS Server Sequences page lists all the RADIUS server sequences that you have defined in Cisco ISE. You can create, edit, or duplicate RADIUS server sequences from this page.

Before you begin

- Before you begin this procedure, you should have a basic understanding of the Proxy Service and must have successfully completed the task in the first entry of the Related Links.
- To perform the following task, you must be a Super Admin or System Admin.

-
- Step 1** Choose **Administration** > **Network Resources** > **RADIUS Server Sequences**.
 - Step 2** Click **Add**.
 - Step 3** Enter the values as required.
 - Step 4** Click **Submit** to save the RADIUS server sequence to be used in policies.
-

Related Topics

- [Configure External RADIUS Servers](#), on page 580
- [Configure a Rule-Based Authentication Policy](#), on page 588
- [RADIUS Server Sequence](#)

Cisco ISE Acting as a TACACS+ Proxy Client

Cisco ISE can act as proxy client to external TACACS+ servers. When it acts as a proxy client, Cisco ISE receives authentication, authorization, and accounting requests from the Network Access Server (NAS) and forwards them to the external TACACS+ server. Cisco ISE accepts the results of the requests and returns them to the NAS.

The TACACS+ External Servers page lists all the external TACACS+ servers that you have defined in Cisco ISE. You can use the filter option to search for specific TACACS+ servers based on the name or description, or both.

Cisco ISE can simultaneously act as a proxy client to multiple external TACACS+ servers. In order to configure multiple external servers, you can use the TACACS+ server sequence page. Refer to the [TACACS+ Server Sequence Settings](#) page for more information.

Related Topics

- [TACACS+ External Server Settings](#), on page 581
- [Configure External TACACS+ Servers](#), on page 582
- [TACACS+ Server Sequence Settings](#), on page 583
- [Define TACACS+ Server Sequences](#), on page 584

TACACS+ External Server Settings

The following table describes the fields in the TACACS External Servers page. The navigation path is **Work Centers** > **Device Administration** > **Network Resources** > **TACACS External Servers** page.

Table 40: TACACS+ External Server Settings

Fields	Usage Guidelines
Name	Enter the name of the TACACS+ external server.

Fields	Usage Guidelines
Description	Enter a description for the TACACS+ external server setting.
Host IP	Enter the IP address of the remote TACACS+ external server.
Connection Port	Enter the port number of the remote TACACS+ external server. The port number is 49.
Timeout	Specify the number of seconds that ISE should wait for a response from the external TACACS+ server. The default is 5 seconds. Valid values are from 1 to 120.
Shared Secret	A string of text that is used to secure a connection with the TACACS+ External Server. The connection will be rejected by the TACACS+ External server if this is not configured correctly.
Use Single Connect	<p>The TACACS protocol supports two modes for associating sessions to connections: Single Connect and Non-Single Connect. Single connect mode reuses a single TCP connection for many TACACS+ sessions that a client may initiate. Non-Single Connect opens a new TCP connection for every TACACS+ session that a client initiates. The TCP connection is closed after each session.</p> <p>You can check the Use Single Connect check box for high-traffic environment and uncheck it for low-traffic environment.</p>

Related Topics

- [TACACS+ External Server Settings](#), on page 581
- [Configure External TACACS+ Servers](#), on page 582
- [TACACS+ Server Sequence Settings](#), on page 583
- [Define TACACS+ Server Sequences](#), on page 584

Configure External TACACS+ Servers

You must configure the external TACACS servers in the Cisco ISE to enable it to forward requests to the external TACACS servers. You can define the timeout period and the number of connection attempts.

Before you begin

- You cannot use the external TACACS servers that you create in this section directly in the policy. You must create a TACACS server sequence and configure it to use the TACACS server that you create in this section. You can then use the TACACS server sequence in the policy sets.
- To perform the following task, you must be a Super Admin or System Admin.

- Step 1** Choose **Work Centers > Device Administration > Network Resources > TACACS External Servers**. The **TACACS External Servers** page appears with a list of external TACACS servers that are defined in Cisco ISE.
- Step 2** Click **Add** to add an external TACACS server.
- Step 3** Enter the values as required.
- Step 4** Click **Submit** to save the external TACACS server configuration.

Related Topics

- [TACACS+ External Server Settings](#), on page 581
- [Configure External TACACS+ Servers](#), on page 582
- [TACACS+ Server Sequence Settings](#), on page 583
- [Define TACACS+ Server Sequences](#), on page 584

TACACS+ Server Sequence Settings

The following table describes the fields in the TACACS Server Sequence page. The navigation path is **Work Centers > Device Administration > Network Resources > TACACS Server Sequence** page.

Table 41: TACACS+ Server Sequence Settings

Fields	Usage Guidelines
Name	Enter the name of the TACACS proxy server sequence.
Description	Enter a description for the TACACS proxy server sequence.
Server List	Select the required TACACS proxy servers from the Available list. The available list contains the list of TACACS proxy servers configured in the TACACS External Services Page.
Logging Control	Check to enable logging control: <ul style="list-style-type: none"> • Local Accounting: Accounting messages are logged by the server that handles requests from devices. • Remote Accounting: Accounting messages are logged by the proxy server that handles requests from devices.

Fields	Usage Guidelines
Username Stripping	<p>Username Prefix/Suffix Stripping:</p> <ul style="list-style-type: none"> • Prefix Strip: Check to strip the username from the prefix. For example, if the subject name is acme\smith and the separator is \, the username becomes smith. The default separator is \. • Suffix Strip: Check to strip the username from the suffix. For example, if the subject name is smith@acme.com and the separator is @, the username becomes smith. The default separator is @.

Related Topics

- [TACACS+ External Server Settings](#), on page 581
- [Configure External TACACS+ Servers](#), on page 582
- [TACACS+ Server Sequence Settings](#), on page 583
- [Define TACACS+ Server Sequences](#), on page 584

Define TACACS+ Server Sequences

TACACS+ server sequences in Cisco ISE allow you to proxy requests from a NAD to an external TACACS+ server that will process the request and return the result to Cisco ISE, which forwards the response to the NAD. The TACACS+ Server Sequences page lists all the TACACS+ server sequences that you have defined in Cisco ISE. You can create, edit, or duplicate TACACS+ server sequences from this page.

Before you begin

- You should have a basic understanding of the Proxy Service, Cisco ISE Admin Groups, Access Levels, Permissions, and Restrictions.
- To perform the following task, you must be a Super Admin or System Admin.
- Ensure that the external TACACS+ servers that you intend to use in the TACACS+ server sequence are already defined.

-
- Step 1** Choose **Work Centers > Device Administration > Network Resources > TACACS External Server Sequence**.
- Step 2** Click **Add**.
- Step 3** Enter the required values.
- Step 4** Click **Submit** to save the TACACS+ server sequence to be used in policies.
-

Related Topics

- [TACACS+ External Server Settings](#), on page 581
- [Configure External TACACS+ Servers](#), on page 582
- [TACACS+ Server Sequence Settings](#), on page 583
- [Define TACACS+ Server Sequences](#), on page 584

Location Based Authorization

Cisco ISE integrates with Cisco Mobility Services Engine (MSE) to introduce physical location-based authorization. Cisco ISE uses information from MSE to provide differentiated network access based on the actual location of the user, as reported by MSE.

With this feature, you can use the endpoint location information to provide network access when a user is in an appropriate zone. You can also add the endpoint location as an additional attribute for policies to define more granulated policy authorization sets based on device location. You can configure conditions within authorization rules that use location-based attributes, for example:

```
MSE.Location Equals LND_Campus1:Building1:Floor2:SecureZone
```

You can define the location hierarchy (campus/building/floor structure) and configure the secure and non-secure zones using the Cisco Prime Infrastructure application. After defining the location hierarchy, you must synchronize the location hierarchy data with the MSE servers. For more information on Cisco Prime Infrastructure, see: <http://www.cisco.com/c/en/us/support/cloud-systems-management/prime-infrastructure/products-user-guide-list.html>.

You can add one or multiple MSE instances to integrate MSE-based location data to the authorization process. You can retrieve the location hierarchy data from these MSEs and configure location-based authorization rules using this data.

To track the endpoint movement, check the Track Movement check box while creating an authorization profile. Cisco ISE will query the relevant MSE for the endpoint location every 5 minutes to verify if the location was changed.

Add an MSE server

Before you begin

To perform the following task, you must be a Super Admin or System Admin.

-
- Step 1** Choose **Administration > Network Resources > Location Services > Location Servers**.
- Step 2** Click **Add**.
- Step 3** Enter the MSE server details, such as server name, hostname/IP address, password, and so on.
- Step 4** Click **Test** to test MSE connectivity using the server details that you have provided.
- Step 5** (Optional) Enter the MAC address of an endpoint in the **Find Location** field and click **Find** to check whether the endpoint is currently connected to this MSE.
- If the endpoint location is found, it is displayed in the following format: *Campus:Building:Floor:Zone*. Sometimes, more than one entry can be displayed depending on the location hierarchy and zone settings. For example, if all the floors of a building (*building1*) in a campus named *Campus1* are defined as non-secure zones, and the Lab Area in the first floor is defined as a secure zone, the following entries will be displayed when the endpoint is located in the Lab Area:
- Found in:
- ```
Campus1#building1#floor1#LabArea
Campus1#building1#floor1#NonSecureZone
```
- Step 6** Click **Submit**.

After a new MSE is added, go to the Location Tree page and click **Get Update** to retrieve its location hierarchy and add it to the Location Tree. If there are filters defined on this tree, these filters are applied on the new MSE entries as well.

## Location Tree

The Location Tree is created by using the location data retrieved from the MSE instances. To view the Location Tree, choose **Administration > Network Resources > Location Services > Location Tree**.

If one building has multiple MSEs, Cisco ISE will collate the location details from all the MSEs and present them as a single tree.

You can select the location entries that are exposed to the authorization policy by using the Location Tree. You can also hide specific locations based on your requirements. It is recommended to update the Location Tree before hiding locations. Hidden locations will remain hidden even when the tree is updated.

If the location entries related to an authorization rule are modified or removed, you must disable the affected rules and set these locations as Unknown or select a replacement location for each affected rule. You must verify the new tree structure before applying the change or canceling the update.

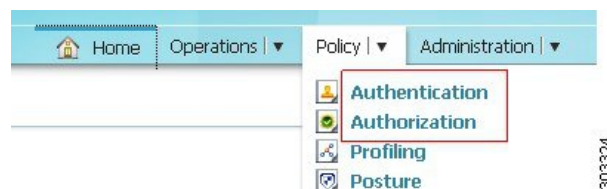
Click **Get Update** to get the latest location hierarchy structure from all MSEs. After verifying the new tree structure, click Save to apply your changes.

## Policy Modes

Cisco ISE provides two types of policy modes, the Simple mode and the Policy Set mode. You can select either one of these to configure authentication and authorization policies. When you change the policy mode, you are prompted to login again to the Cisco ISE interface. If you switch from the Policy Set mode to the Simple mode, all the policy set data is deleted except the default policy. The Policy menu options change based on the policy mode selection.

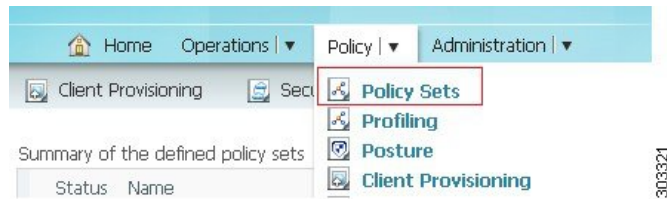
- Simple Mode—If you select Simple mode, you can define authentication and authorization policies separately in the Policy menu.

**Figure 52: Simple Mode Policy Menu**



- Policy Set Mode—If you select Policy Set mode, you can create policy sets and logically group authentication and authorization within the same group. You can have several groups based on what you need.

Figure 53: Policy Set Mode Policy Menu



### Related Topics

- [Guidelines for Changing Policy Modes](#)
- [Change Policy Modes](#), on page 587
- [Simple Authentication Policies](#), on page 564
- [Configure a Rule-Based Authentication Policy](#), on page 588
- [Policy Sets](#), on page 590

## Change Policy Modes

The following are the guidelines for changing policy modes:

- After you do a fresh install or upgrade from Cisco ISE, Release 1.1, the Simple Mode policy model is selected by default.
- If you choose to switch to Policy Set Mode from Simple Mode, the authentication and authorization policies are migrated to the default policy set.
- If you choose to switch to Simple Mode from Policy Set Mode, the authentication and authorization of the default policy set are migrated to be the authentication and authorization policies. All other policy set policies are deleted.

---

**Step 1** Choose **Administration** > **System** > **Settings** > **Policy Sets**.

**Step 2** Enable or Disable the Policy Set mode.

**Step 3** Click **Save**.

You will be prompted to login again, for the new policy mode to come into effect.

---

### Related Topics

- [Simple Authentication Policies](#), on page 564
- [Rule-Based Authentication Policies](#), on page 566
- [Policy Sets](#), on page 590

## Configure a Simple Authentication Policy

The procedure for configuring a simple authentication policy includes defining an allowed protocols service and configuring a simple authentication policy.

**Before you begin**

- To configure a simple authentication policy using the RADIUS server sequence, you should have a basic understanding of the Cisco ISE authentication policies and proxy service to understand authentication types and the protocols that are supported by various databases.
- You should have defined an allowed protocol access service or RADIUS server sequence.
- To perform the following task, you must be a Super Admin or System Admin.

You can also use this process to configure a simple policy using RADIUS server sequence.

- 
- Step 1** Choose **Policy** > **Authentication**.
- Step 2** Click **OK** on the message that appears.
- Step 3** Enter the values as required.
- Step 4** Click **Save** to save your simple authentication policy.
- 

**Related Topics**

- [Cisco ISE Authentication Policies](#), on page 561
- [Define Allowed Protocols for Network Access](#), on page 576
- [RADIUS Server Sequence](#)
- [Cisco ISE Acting as a RADIUS Proxy Server](#), on page 579

## Configure a Rule-Based Authentication Policy

In a rule-based policy, you can define conditions that allows Cisco ISE to dynamically choose the allowed protocols and identity sources. You can define one or more conditions using any of the attributes from the Cisco ISE dictionary.




---

**Tip** We recommend that you create the allowed protocol access services, conditions, and identity source sequences before you create the rule-based authentication policy. If you want to use the RADIUS server sequence, you can define the RADIUS server sequence before you create the policy.

---

**Before you begin**

- You should have a basic understanding of the rule-based authentication policies, defined allowed protocols for network access, created identity source sequence, and RADIUS server sequence (if you want to use the RADIUS server sequence in place of the allowed protocol access service).
- Cisco ISE comes with predefined rule-based authentication policies for the Wired 802.1X, Wireless 802.1X, and Wired MAB use cases.
- To perform the following task, you must be a Super Admin or System Admin.
- If your users are defined in external identity sources, ensure that you have configured these identity sources in Cisco ISE.





---

**Note** When you switch between a simple and a rule-based authentication policy, you will lose the policy that you configured earlier. For example, if you have a simple authentication policy configured and you want to move to a rule-based authentication policy, you will lose the simple authentication policy. Also, when you move from a rule-based authentication policy to a simple authentication policy, you will lose the rule-based authentication policy.

---

**Step 1** Choose **Policy > Authentication**.

**Step 2** Click the **Rule-Based** radio button.

**Step 3** Click OK on the message that appears.

**Step 4** Click the action icon and click **Insert new row above** or **Insert new row below** based on where you want the new policy to appear in this list. The policies will be evaluated sequentially.

Each row in this rule-based policy page is equivalent to the simple authentication policy. Each row contains a set of conditions that determine the allowed protocols and identity sources.

**Step 5** Enter the values as required to create a new authentication policy.

**Step 6** Click **Save** to save your rule-based authentication policies.

You cannot specify the “UserName” attribute when configuring an authentication policy when the EAP-FAST client certificate is sent in the outer TLS negotiation. Cisco recommends using certificate fields like “CN” and “SAN,” for example.

ISE does not restrict a user or machine EAP-TLS authentication against Active Directory when the account in Active Directory is set to deny the user or machine using logon hours, locked-out, or workstations attributes. You should not use these attributes to restrict a user or machine for EAP-TLS authentications.

---

### Related Topics

[Rule-Based Authentication Policies](#), on page 566

[Configure a Rule-Based Authentication Policy](#), on page 588

[Define Allowed Protocols for Network Access](#), on page 576

[RADIUS Server Sequence](#)

[Authentication Policy Built-In Configurations](#), on page 592

[Attributes Supported by Dictionaries](#), on page 568

[Cisco ISE Acting as a RADIUS Proxy Server](#), on page 579

[Cisco ISE Authentication Policies](#), on page 561

## Default Authentication Policy

The last row in the authentications policy page is the default policy that will be applied if none of the rules match the request. You can edit the allowed protocols and identity source selection for the default policy.

It is a good practice to choose Deny Access as the identity source in the default policy if the request does not match any of the other policies that you have defined.

# Policy Sets

Policy sets enable you to logically group authentication and authorization policies within the same set. You can have several policy sets based on an area, such as policy sets based on location, access type and similar parameters.

Policy sets are first-match policies. Each policy has a condition that can be a simple or a compound condition, and have the following supported dictionaries:

- Airspace
- Cisco
- Cisco-BBSM
- Cisco-VPN3000
- Device, Microsoft
- NetworkAccess
- RADIUS

Once the policy set is matched and selected, its authentication and authorization policies are evaluated. In addition, a global authorization exception policy is available as part of the policy set model.

There is always one policy set defined, which is the default policy set.

## Related Topics

[Policy Set Evaluation Flow](#), on page 591

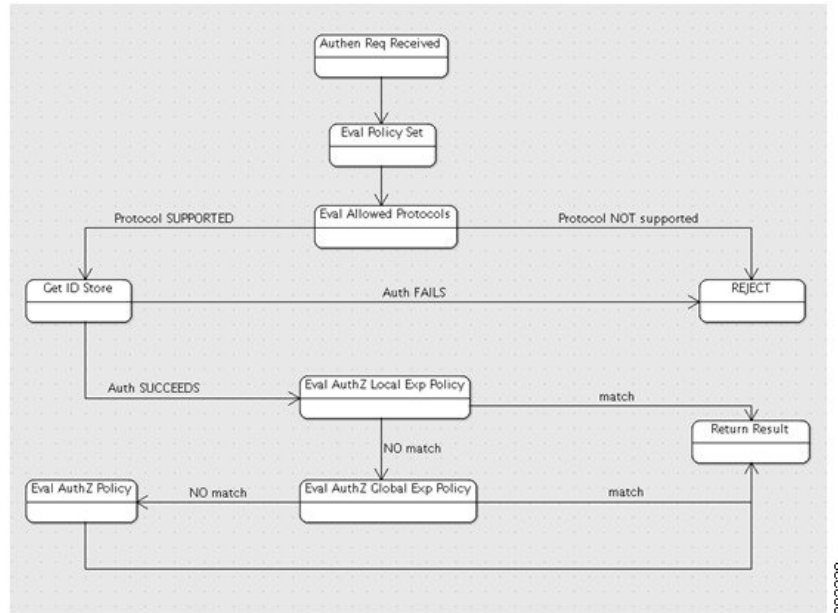
[Guidelines for Creating Policy Sets](#), on page 591

[Global Authorization Exception Policy](#), on page 592

[Configure Policy Sets](#), on page 592

# Policy Set Evaluation Flow

Figure 54: Policy Set Authentication and Authorization Evaluation Flow



The sequence of policy set and the authentication and authorization evaluation flow is as follows:

1. Evaluate policy set (by evaluating the policy set condition). As a result, one policy set is selected.
2. Evaluate allowed protocols rules of the selected policy set.
3. Evaluate ID store rules of the selected policy set.
4. Evaluate authorization rules of the selected policy set, based on the following paradigm:
  - Evaluate the local exception policy in case it is defined
  - If no match is found in Step 1 above, evaluate global exception policy if defined
  - If no match is found in Step 2 above, evaluate authorization rules

If none of the policy set matches, the default policy set will be selected.

## Guidelines for Creating Policy Sets

Following are the guidelines for creating policy sets:

- Rules are configured with names, conditions, and results. You must define authentication and authorization rules in order to implement a policy set. The default pre-configured policy set that is installed automatically with ISE, as well as any new policy sets that you create, are automatically created with the existing default authentication and authorization policy rules which you can then edit or supplement.
- You can duplicate rules that are of the same rule type (either authentication or authorization) and only within the same policy set.

- Rules cannot be shared by different policy sets; each policy set has its own rule, however conditions can be shared in case you use the condition library.

## Global Authorization Exception Policy

The global authorization exception policy allows you to define rules that apply to all policy sets. The global authorization exception policy is added to each authorization policy of all the policy set. Global authorization exception policy can be updated by selecting the Global Exceptions option from the policy set list.

Each authorization policy can have local exception rule, global exception rule, and regular rules. Once you configure the local authorization exception rule, (for some authorization policies) the global exception authorization rules are displayed in read-only mode in conjunction to the local authorization exception rule. The local authorization exception rule can overwrite the global exception rule. The authorization rules are processed in the following order: first the local exception rule, then the global exception rule, and finally, the regular rule of the authorization policy.

## Configure Policy Sets

You can use this page to configure Policy sets.

### Before you begin

You should have selected the policy mode as Policy Set to be able to configure Policy sets. To do this, go to **Administration > System > Settings > Policy Sets**.

- 
- Step 1** Choose **Policy > Policy Sets**.
  - Step 2** Click the **Default** policy. The default policy is displayed in the right.
  - Step 3** Click the plus (+) sign on top and choose **Create Above**.
  - Step 4** Enter the name, description and a condition for this group policy.
  - Step 5** Define the authentication policy.
  - Step 6** Define the authorization policy.
  - Step 7** Click **Submit**. After you configure a policy set, Cisco ISE logs you out. You must log in again to access the Admin portal.
- 

### Related Topics

- [Change Policy Modes](#), on page 587
- [Configure a Rule-Based Authentication Policy](#), on page 588
- [Policy Set Evaluation Flow](#), on page 591
- [Guidelines for Creating Policy Sets](#), on page 591
- [Global Authorization Exception Policy](#), on page 592

## Authentication Policy Built-In Configurations

Cisco ISE is packaged with several default configurations that are part of common use cases.

**Table 42: Authentication Policy Configuration Defaults**

| Name                                                        | Path in the User Interface                                                   | Description                                                                                                                                                                                                              | Additional Information                                                                                                                                                                                                                                      |
|-------------------------------------------------------------|------------------------------------------------------------------------------|--------------------------------------------------------------------------------------------------------------------------------------------------------------------------------------------------------------------------|-------------------------------------------------------------------------------------------------------------------------------------------------------------------------------------------------------------------------------------------------------------|
| Default Network Access Allowed Protocols Access Service     | Policy > Policy Elements > Configuration > Allowed Protocols                 | This default is the built-in network access allowed protocols service to be used in authentication policies.                                                                                                             | You can use this access service for wired and wireless 802.1X, and wired MAB authentication policies.                                                                                                                                                       |
| Wired 802.1X Compound Condition                             | Policy > Policy Elements > Conditions > Authentication > Compound Conditions | This compound condition checks for the following attributes and values: <ul style="list-style-type: none"> <li>• RADIUS:Service-Type equals Framed</li> <li>• RADIUS:NAS-Port-Type equals Ethernet</li> </ul>            | This compound condition is used in the wired 802.1X authentication policy. Any request that matches the criteria specified in this policy would be evaluated based on the wired 802.1X authentication policy.                                               |
| Wireless 802.1X Compound Condition                          | Policy > Policy Elements > Conditions > Authentication > Compound Conditions | This compound condition checks for the following attributes and values: <ul style="list-style-type: none"> <li>• RADIUS:Service-Type equals Framed</li> <li>• RADIUS:NAS-Port-Type equals Wireless-IEEE802.11</li> </ul> | This compound condition is used in the wireless 802.1X authentication policy. Any request that matches the criteria specified in this policy would be evaluated based on the wireless 802.1X authentication policy.                                         |
| Wired MAB Compound Condition                                | Policy > Policy Elements > Conditions > Authentication > Compound Conditions | This compound condition checks for the following attributes and values: <ul style="list-style-type: none"> <li>• RADIUS:Service-Type equals Call-Check</li> <li>• RADIUS:NAS-Port-Type equals Ethernet</li> </ul>        | This compound condition is used in the wired MAB authentication policy. Any request that matches the criteria specified in this policy would be evaluated based on the wired MAB authentication policy.                                                     |
| Catalyst Switch Local Web Authentication Compound Condition | Policy > Policy Elements > Conditions > Authentication > Compound Conditions | This compound condition checks for the following attributes and values: <ul style="list-style-type: none"> <li>• RADIUS:Service-Type equals Outbound</li> <li>• RADIUS:NAS-Port-Type equals Ethernet</li> </ul>          | To use this compound condition, you must create an authentication policy that would check for this condition. You can also define an access service based on your requirements or use the default network access allowed protocols service for this policy. |

| Name                                                                      | Path in the User Interface                                                   | Description                                                                                                                                                                                                                       | Additional Information                                                                                                                                                                                                                                      |
|---------------------------------------------------------------------------|------------------------------------------------------------------------------|-----------------------------------------------------------------------------------------------------------------------------------------------------------------------------------------------------------------------------------|-------------------------------------------------------------------------------------------------------------------------------------------------------------------------------------------------------------------------------------------------------------|
| Wireless Lan Controller (WLC) Local Web Authentication Compound Condition | Policy > Policy Elements > Conditions > Authentication > Compound Conditions | This compound condition checks for the following attributes and values: <ul style="list-style-type: none"> <li>• RADIUS:Service-Type equals Outbound</li> <li>• RADIUS:NAS-Port-Type equals Wireless-IEEE802.11</li> </ul>        | To use this compound condition, you must create an authentication policy that would check for this condition. You can also define an access service based on your requirements or use the default network access allowed protocols service for this policy. |
| Wired 802.1X Authentication Policy                                        | Policy > Authentication > Rule-Based                                         | This policy uses the wired 802.1X compound condition and the default network access allowed protocols service. This policy will evaluate requests that match the criteria specified in the wired 802.1X compound condition.       | This default policy uses the internal endpoints database as its identity source. You can edit this policy to configure any identity source sequence or identity source based on your needs.                                                                 |
| Wireless 802.1X Authentication Policy                                     | Policy > Authentication > Rule-Based                                         | This policy uses the wireless 802.1X compound condition and the default network access allowed protocols service. This policy will evaluate requests that match the criteria specified in the wireless 802.1X compound condition. | This default policy uses the internal endpoints database as its identity source. You can edit this policy to configure any identity source sequence or identity source based on your needs.                                                                 |
| Wired MAB Authentication Policy                                           | Policy > Authentication > Rule-Based                                         | This policy uses the wired MAB compound condition and the default network access allowed protocols service. This policy will evaluate requests that match the criteria specified in the wired MAB compound condition.             | This default policy uses the internal endpoints database as its identity source.                                                                                                                                                                            |

**Related Topics**

[Network Access Service](#), on page 575

[Configure a Rule-Based Authentication Policy](#), on page 588

# View Authentication Results

Cisco ISE provides various ways to view real-time authentication summary.

## Before you begin

To perform the following task, you must be a Super Admin or System Admin.

---

**Step 1** Choose **Operations** > **RADIUS Livelog** to view real-time authentication summary.

**Step 2** You can view the authentication summary in the following ways:

- Hover your mouse cursor over the Status icon to view the results of the authentication and a brief summary. A pop-up with status details appears.
- Enter your search criteria in any one or more of the text boxes that appear at the top of the list, and press **Enter**, to filter your results.
- Click the magnifier icon in the **Details** column to view a detailed report.

**Note** As the **Authentication Summary** report or dashboard collects and displays the latest data corresponding to failed or passed authentications, the contents of the report appear after a delay of a few minutes.

---

## Authentication Dashlet

The Cisco ISE dashboard provides a summary of all authentications that take place in your network and for your devices. It provides at-a-glance information about authentications and authentication failures in the **Authentications** dashlet.

The **RADIUS Authentications** dashlet provides the following statistical information about the authentications that Cisco ISE has handled:

- The total number of RADIUS authentication requests that Cisco ISE has handled, including passed authentications, failed authentications, and simultaneous logins by the same user.
- The total number of failed RADIUS authentications requests that Cisco ISE has processed.

You can also view a summary of TACACS+ authentications. The TACACS+ Authentications dashlet provides statistical information for device authentications.

For more information about device administration authentications, see [TACACS Live Logs, on page 1155](#). For additional information about RADIUS Live Logs settings, see [RADIUS Live Logs, on page 1149](#).

### ISE Community Resource

For information on how to troubleshoot failed authentications and authorizations, see [How To: Troubleshoot ISE Failed Authentications & Authorizations](#).

## Authentication Reports and Troubleshooting Tools

Apart from the authentication details, Cisco ISE provides various reports and troubleshooting tools that you can use to efficiently manage your network.

There are various reports that you can run to understand the authentication trend and traffic in your network. You can generate reports for historical as well as current data. The following is a list of authentication reports:

- AAA Diagnostics
- RADIUS Accounting
- RADIUS Authentication
- Authentication Summary



---

**Note** You must enable IPv6 snooping on Cisco Catalyst 4000 Series switches, otherwise IPv6 address will not be mapped to the authentication sessions and will not be displayed in the show output. Use the following commands to enable IPv6 snooping:

```
vlan config <vlan-number>
 ipv6 snooping
 end
ipv6 nd rguard policy router
 device-role router
interface <access-interface>
 ipv6 nd rguard
interface <uplink-interface>
 ipv6 nd rguard attach-policy router
 end
```

---





## CHAPTER 21

# Manage Authorization Policies and Profiles

- [Cisco ISE Authorization Policies, on page 597](#)
- [Cisco ISE Authorization Profiles, on page 597](#)
- [Default Authorization Policy, Rule, and Profile Configuration, on page 601](#)
- [Configure Authorization Policies, on page 605](#)
- [Permissions for Authorization Profiles, on page 609](#)
- [Downloadable ACLs, on page 610](#)
- [Machine Access Restriction for Active Directory User Authorization, on page 611](#)

## Cisco ISE Authorization Policies

Authorization policies are a component of the Cisco ISE network authorization service. This service allows you to define authorization policies and configure authorization profiles for specific users and groups that access your network resources.

Authorization policies can contain conditional requirements that combine one or more identity groups using a compound condition that includes authorization checks that can return one or more authorization profiles. In addition, conditional requirements can exist apart from the use of a specific identity group (such as in using the default “Any”).

Authorization policies are used when creating authorization profiles in Cisco Identity Services Engine (Cisco ISE). An authorization policy is composed of authorization rules. Authorization rules have three elements: name, attributes, and permissions. The permission element is that maps to an authorization profile.

## Cisco ISE Authorization Profiles

Authorization policies associate rules with specific user and group identities to create the corresponding profiles. Whenever these rules match the configured attributes, the corresponding authorization profile that grants permission is returned by the policy and network access is authorized accordingly.

For example, authorization profiles can include a range of permissions that are contained in the following types:

- Standard profiles
- Exception profiles
- Device-based profiles

Profiles consist of attributes chosen from a set of resources, which are stored in any of the available vendor dictionaries, and these are returned when the compound condition for the specific authorization policy matches. Because authorization policies can include compound condition mapping to a single network service rule, these can also include a list of authorization checks.

For simple scenarios, all authorization checks are made using the AND Boolean operator within the rule. For advanced scenarios, any type of authorization verification expression can be used, but all these authorization verifications must comply with the authorization profiles to be returned. Authorization verifications typically comprise one or more conditions, including a user-defined name that can be added to a library, which can then be reused by other authorization policies.

#### Related Topics

- [Authorization Policy Terminology](#), on page 598
- [Authorization Policies and Supported Dictionaries](#), on page 600
- [Configure Authorization Policies](#), on page 605
- [Permissions for Authorization Profiles](#), on page 609
- [Configure Permissions for Downloadable ACLs](#), on page 610

## Authorization Policy Terminology

You can define authorization profiles and policies for network authorization of users to access Cisco ISE network and its resources. Cisco ISE also uses downloadable ACLs (DACLS), which are configured and implemented through authorization profiles. For more information about authorization profiles, see [Authorization Profile, on page 599](#). For more information about DACLS, see [Downloadable ACLs, on page 610](#).

## Network Authorization

Network authorization controls user access to the network and its resources and what each user can do on the system with those resources. Activate network authorization from Cisco ISE by defining sets of permissions that authorize read, write, and execute privileges. Cisco ISE lets you create a number of different authorization policies to suit your network needs. This release supports only RADIUS access to the Cisco ISE network and its resources.

## Policy Elements

Policy elements are components that define an authorization policy and are as follows:

- Rule name
- Identity groups
- Conditions
- Permissions

These policy elements are referenced when you create policy rules and your choice of conditions and attributes can create specific types of authorization profiles.

## Authorization Profile

An authorization profile acts as a container where a number of specific permissions allow access to a set of network services. The authorization profile is where you define a set of permissions to be granted for a network access request and can include:

- A profile name
- A profile description
- An associated ACL (Filter-ID)
- An associated DACL
- An associated VLAN
- An associated SGACL
- Any number of other dictionary-based attributes

## Authorization Policy

An authorization policy can consist of a single rule or a set of rules that are user-defined. These rules act to create a specific policy. For example, a standard policy can include the rule name using an If-Then convention that links a value entered for identity groups with specific conditions or attributes to produce a specific set of permissions that create a unique authorization profile. There are two authorization policy options you can set:

- First Matched Rules Apply
- Multiple Matched Rule Applies

These two options direct Cisco ISE to use either the first matched or the multiple matched rule type listed in the standard policy table when it matches the user's set of permissions. These are the two types of authorization policies that you can configure:

- **Standard**—Standard policies are policies created to remain in effect for long periods of time, to apply to a larger group of users, devices, or groups, and to allow access to specific or all network endpoints. Standard policies are intended to be stable and apply to a large groups of users, devices, and groups that share a common set of privileges.

Standard policies can be used as templates that you modify to serve the needs of a specific identity group, using specific conditions or permissions, to create another type of standard policy to meet the needs of new divisions, or user groups, devices, or network groups.

- **Exception**—By contrast, exception policies are appropriately named because this type of policy acts as an exception to the standard policies. Exception policies are intended for authorizing limited access that is based on a variety of factors, such as short-term policy duration, specific types of network devices, network endpoints or groups, or the need to meet special conditions or permissions or an immediate requirement.

Exception policies are created to meet an immediate or short-term need, such as authorizing a limited number of users, devices, or groups to access network resources. An exception policy lets you create a specific set of customized values for an identity group, condition, or permission that are tailored for one user or a subset of users. This allows you to create different or customized policies to meet your corporate, group, or network needs.

## Access Control Lists

An Access Control List (ACL) in the Cisco ISE system is a list of permissions attached to a specific object or network resource. An ACL specifies which users or groups are granted access to an object, as well as what operations are allowed on a given object or network resource. Each entry in a typical ACL specifies a subject and an operation or provides the state (such as, Permit or Deny).

## Authorization Policies and Supported Dictionaries

For authorization policy types, the verification must comply with the authorization profiles to be returned.

Verifications typically include one or more conditions that include a user-defined name that can then be added to a library and reused by other policies. You define conditions using the attributes from the Cisco ISE dictionary, which supports the following dictionaries:

- System-defined dictionary:
  - RADIUS
- RADIUS-vendor dictionaries
  - Airespace
  - Cisco
  - Cisco-BBSM
  - Cisco-VPN3000
  - Microsoft

## Guidelines for Configuring Authorization Policies and Profiles

Observe the following guidelines when managing or administering authorization policies and profiles:

- Rule names you create must use only the following supported characters:
  - Symbols: plus (+), hyphen (-), underscore (\_), period (.), and a space ( ).
  - Alphabetic characters: A-Z and a-z.
  - Numeric characters: 0-9.
- Identity groups default to “Any” (you can use this global default to apply to all users).
- Conditions allow you to set one or more policy values. However, conditions are optional and are not required to create an authorization policy. These are the two methods for creating conditions:
  - Choose an existing condition or attribute from a corresponding dictionary of choices.
  - Create a custom condition that allows you to select a suggested value or use a text box to enter a custom value.
- Condition names you create must use only the following supported characters:
  - Symbols: hyphen (-), underscore (\_), and period (.).

- Alphabetic characters: A-Z and a-z.
- Numeric characters: 0-9.
- Permissions are important when choosing an authorization profile to use for a policy. A permission can grant access to specific resources or allow you to perform specific tasks. For example, if a user belongs to a specific identity group (such as Device Admins), and the user meets the defined conditions (such as a site in Boston), then this user is granted the permissions associated with that group (such as access to a specific set of network resources or permission to perform a specific operation on a device).
- When you use the **radius** attribute **Tunnel-Private-Group-ID** in an authorization condition, you must mention both the tag and the value in the condition when the **EQUALS** operator is being used, for example:  

```
Tunnel-Private-Group-ID EQUALS (tag=0) 77
```
- Make sure that you click Save to save the new or modified policy or profile in the Cisco ISE database.



**Note** As of Cisco ISE 1.4, ANC replaces Endpoint Protection Services (EPS). ANC provides additional classifications, and performance improvements. While using ERS attributes in a policy might still work for some ANC actions some of the time, you should use ANC attributes. For example, **Session:EPSSStatus=Quarantine** may fail. Use **Session:ANCPolicy** as a condition in a policy.

## Default Authorization Policy, Rule, and Profile Configuration

The Cisco ISE software comes installed with a number of preinstalled default conditions, rules, and profiles that provide common settings that make it easier for you to create the rules and policies required in Cisco ISE authorization policies and profiles.

The table describes built-in configuration defaults that contain specified values in Cisco ISE.

**Table 43: Authorization Policy, Profile, and Rule Configuration Defaults**

| Name                                        | Path in the User Interface | Description | Additional Information |
|---------------------------------------------|----------------------------|-------------|------------------------|
| Authorization Policy Configuration Defaults |                            |             |                        |

| Name                                                   | Path in the User Interface                                                     | Description                                                                                                                                                                                                                   | Additional Information                                                                                                                                                                                                                                                         |
|--------------------------------------------------------|--------------------------------------------------------------------------------|-------------------------------------------------------------------------------------------------------------------------------------------------------------------------------------------------------------------------------|--------------------------------------------------------------------------------------------------------------------------------------------------------------------------------------------------------------------------------------------------------------------------------|
| Default Compound Conditions for Authorization Policies | Policy > Policy Elements > Conditions > Authorization                          | These are preinstalled configuration defaults for conditions, rules, and profiles to be used in authorization policies.                                                                                                       | You can use the related attributes for creating authorization policies: <ul style="list-style-type: none"> <li>• Wired 802.1x</li> <li>• Wired MAB</li> <li>• Wireless 802.1x</li> <li>• Catalyst Switch Local Web authentication</li> <li>• WLC Web authentication</li> </ul> |
| Wired MAB Compound Condition                           | Policy > Policy Elements > Conditions > Authorization > Compound Conditions    | This compound condition checks for the following attributes and values: <ul style="list-style-type: none"> <li>• RADIUS:Service-Type = Call-Check</li> <li>• RADIUS:NAS-Port-Type = Ethernet</li> </ul>                       | This compound condition is used in the Wired MAB authorization policy. Any request that matches the criteria specified in this policy would be evaluated based on the Wired MAB authorization policy.                                                                          |
| Wireless 802.1X Compound Condition                     | Policy > Policy Elements > Conditions > Authorization > Compound Conditions    | This compound condition checks for the following attributes and values: <ul style="list-style-type: none"> <li>• RADIUS:Service-Type = Framed</li> <li>• RADIUS:NAS-Port-Type = Wireless-IEEE802.11</li> </ul>                | This compound condition is used in the Wireless 802.1X authorization policy. Any request that matches the criteria specified in this policy would be evaluated based on the Wireless 802.1X authorization policy.                                                              |
| Authorization Profile Configuration Defaults           |                                                                                |                                                                                                                                                                                                                               |                                                                                                                                                                                                                                                                                |
| Blacklist_Access                                       | Policy > Policy Elements > Results > Authorization Profiles > Blacklist_Access | This authorization profile rejects access to devices that are block listed. All block listed devices are redirected to the following URL: <a href="http://localhost:8443/portal/Build">http://localhost:8443/portal/Build</a> | This default authorization profile is applied for all endpoints that are declared as “lost” in the My Devices Portal.                                                                                                                                                          |

| Name                                                                      | Path in the User Interface                                                    | Description                                                                                                                                                                                                                                                                                                                                                     | Additional Information                                                                                                                                                                                                    |
|---------------------------------------------------------------------------|-------------------------------------------------------------------------------|-----------------------------------------------------------------------------------------------------------------------------------------------------------------------------------------------------------------------------------------------------------------------------------------------------------------------------------------------------------------|---------------------------------------------------------------------------------------------------------------------------------------------------------------------------------------------------------------------------|
| Cisco_IP_Phones                                                           | Policy > Policy Elements > Results > Authorization Profiles > Cisco_IP_Phones | <p>This authorization profiles uses a configuration default profile with the following values:</p> <ul style="list-style-type: none"> <li>• Name: Cisco IP Phones</li> <li>• DACL: PERMIT_ALL_TRAFFIC</li> <li>• VSA: <code>comp-intel-as-voice</code></li> </ul> <p>This profile will evaluate requests that match the criteria specified in this profile.</p> | <p>This default authorization profile uses the DACL and vendor-specific attribute (VSA) to authorize all “voice” traffic (PERMIT_ALL_TRAFFIC).</p>                                                                        |
| Authorization Policy Configuration Defaults                               |                                                                               |                                                                                                                                                                                                                                                                                                                                                                 |                                                                                                                                                                                                                           |
| Wired 802.1X Compound Condition                                           | Policy > Policy Elements > Conditions > Authorization > Compound Conditions   | <p>This compound condition checks for the following attributes and values:</p> <ul style="list-style-type: none"> <li>• RADIUS:Service-Type = Framed</li> <li>• RADIUS:NAS-Port-Type = Ethernet</li> </ul>                                                                                                                                                      | <p>This compound condition is used in the Wired 802.1X authorization policy.</p> <p>Any request that matches the criteria specified in this policy would be evaluated based on the Wired 802.1X authorization policy.</p> |
| Catalyst Switch Local Web Authentication Compound Condition               | Policy > Policy Elements > Conditions > Authorization > Compound Conditions   | <p>This compound condition checks for the following attributes and values:</p> <ul style="list-style-type: none"> <li>• RADIUS:Service-Type = Outbound</li> <li>• RADIUS:NAS-Port-Type = Ethernet</li> </ul>                                                                                                                                                    | <p>To use this compound condition, you must create an authorization policy that would check for this condition.</p>                                                                                                       |
| Wireless Lan Controller (WLC) Local Web Authentication Compound Condition | Policy > Policy Elements > Conditions > Authorization > Compound Conditions   | <p>This compound condition checks for the following attributes and values:</p> <ul style="list-style-type: none"> <li>• RADIUS:Service-Type = Outbound</li> <li>• RADIUS:NAS-Port-Type = Wireless-IEEE802.11</li> </ul>                                                                                                                                         | <p>To use this compound condition, you must create an authorization policy that would check for this condition.</p>                                                                                                       |

| Name                                        | Path in the User Interface    | Description                                                                                                                                                                                                                                                                                                                 | Additional Information                                                                                                                      |
|---------------------------------------------|-------------------------------|-----------------------------------------------------------------------------------------------------------------------------------------------------------------------------------------------------------------------------------------------------------------------------------------------------------------------------|---------------------------------------------------------------------------------------------------------------------------------------------|
| Black List Default Authorization Rule       | Policy > Authorization Policy | This authorization policy uses a configuration default rule with the following values: <ul style="list-style-type: none"> <li>• Rule Name: Black List Default</li> <li>• Endpoint Identity Group: Blacklist</li> <li>• Conditions: Any</li> <li>• Permissions/Authorization Profile: Blacklist_Access</li> </ul>            | This default rule is designed to appropriately provision “lost” user devices until they are either removed from the system or “reinstated.” |
| Profiled Cisco IP Phones Authorization Rule | Policy > Authorization Policy | This authorization policy uses a configuration default rule with the following values: <ul style="list-style-type: none"> <li>• Rule Name: Profiled Cisco IP Phones</li> <li>• Endpoint Identity Group: Cisco-IP-Phones</li> <li>• Conditions: Any</li> <li>• Permissions/Authorization Profile: Cisco_IP_Phones</li> </ul> | This default rule uses Cisco IP Phones as its default endpoint identity group and the values listed in this table.                          |
| Authorization Rule Configuration Defaults   |                               |                                                                                                                                                                                                                                                                                                                             |                                                                                                                                             |
| Default Authorization Rule                  | Policy > Authorization Policy | This authorization policy uses a configuration default rule with the following values: <ul style="list-style-type: none"> <li>• Rule Name: Default</li> <li>• Endpoint Identity Group: Any</li> <li>• Conditions: Any</li> <li>• Authorization Profile: PermitAccess</li> </ul>                                             | This default rule uses “any” as its default endpoint identity group and the values listed in this table.                                    |



## Default Authorization Rules

The Cisco ISE software comes with a number of pre-configured authorization rules that make it easier for you to create the authorization policies and profiles. These rules are disabled by default. You can enable these rules based on your requirements.

**Table 44: Pre-configured Authorization Rules**

| Rule Name                     | Description                                                                                                              | Conditions                                                                                                                     | Permissions            |
|-------------------------------|--------------------------------------------------------------------------------------------------------------------------|--------------------------------------------------------------------------------------------------------------------------------|------------------------|
| Basic_Authenticated_Access    | To enable access to authenticated users.                                                                                 | Network_Access_Authentication_Passed                                                                                           | PermitAccess           |
| Wi-Fi_Redirect_to_Guest_Login | To redirect users to the CWA Portal.                                                                                     | Wireless_MAB                                                                                                                   | Cisco_WebAuth          |
| Wi-Fi_Guest_Access            | To permit Guest access, after a Guest user is authenticated from the WebAuth.                                            | (GuestType_Daily (default) OR GuestType_Weekly (default) OR GuestType_Contractor (default) ) AND (Wireless_MAB AND Guest_Flow) | Guest AND PermitAccess |
| Compliant_Devices_Access      | To enable access for compliant devices.                                                                                  | Compliant_Devices                                                                                                              | PermitAccess           |
| Employee_Onboarding           | Any wireless 802.1X authentication that uses MSCHAPv2 would be redirected to the Native Supplicant Provisioning process. | (Wireless_802.1X AND EAP-MSCHAPv2)                                                                                             | NSP_Onboard AND BYOD   |



**Note** The pre-configured authorization rules are available only on new installations. These rules are not available if you are upgrading from earlier versions of Cisco ISE.

## Configure Authorization Policies

The Authorization Policy page lets you display, create, duplicate, modify, or delete authorization policies. The following authorization policy profile sections reference example actions directed at a standard authorization policy. You can follow the same process for managing an exception authorization policy.

### Before you begin

Before you begin this procedure, you should have a basic understanding of simple and rule-based conditions, the basic building blocks of identity groups, conditions, and permissions, and how they are used in the Admin portal.

**Step 1** Choose **Policy > Authorization > Standard**.

**Step 2** Click the down arrow on the far-right and select either **Insert New Rule Above** or **Insert New Rule Below**.

**Step 3** Enter the rule name and select identity group, condition, attribute and permission for the authorization policy.

Not all attributes you select will include the “Equals,” “Not Equals,” “Matches,” “Starts With,” or “Not Starts With” operator options.

The “Matches” operator supports and uses regular expressions (REGEX) not wildcards.

**Note** You must use the “equals” operator for straight forward comparison. “Contains” operator can be used for multi-value attributes. “Matches” operator should be used for regular expression comparison. When “Matches” operator is used, regular expression will be interpreted for both static and dynamic values.

**Step 4** Click **Done**.

**Step 5** Click **Save** to save your changes to the Cisco ISE system database and create this new authorization policy.

### Related Topics

[Create Simple Conditions](#), on page 548

[Create Compound Conditions](#), on page 549

[Simple and Compound Conditions](#), on page 547

[Authorization Policy Settings](#), on page 1086

## Authorization Policy Attributes and Conditions

To reuse a valid attribute when creating authorization policy conditions, select it from a dictionary that contains the supported attributes. For example, Cisco ISE provides an attribute named `AuthenticationIdentityStore`, which is located in the `NetworkAccess` dictionary. This attribute identifies the last identity source that was accessed during the authentication of a user:

- When a single identity source is used during authentication, this attribute includes the name of the identity store in which the authentication succeeded.
- When an identity source sequence is used during authentication, this attribute includes the name of the last identity source accessed.

You can use the `AuthenticationStatus` attribute in combination with the `AuthenticationIdentityStore` attribute to define a condition that identifies the identity source to which a user has successfully been authenticated. For example, to check for a condition where a user authenticated using an LDAP directory (LDAP13) in the authorization policy, you can define the following reusable condition:

```
If NetworkAccess.AuthenticationStatus EQUALS AuthenticationPassed AND
NetworkAccess.AuthenticationIdentityStore EQUALS LDAP13
```



**Note** The `AuthenticationIdentityStore` represents a text field that allows you to enter data for the condition. Ensure that you enter or copy the name correctly into this field. If the name of the identity source changes, you must ensure to modify this condition to match the change to the identity source.

To define authorization conditions that are based on an endpoint identity group that has been previously authenticated, Cisco ISE supports authorization that was defined during endpoint identity group 802.1X authentication status. When Cisco ISE performs 802.1X authentication, it extracts the MAC address from the “Calling-Station-ID” field in the RADIUS request and uses this value to look up and populate the session cache for the device's endpoint identity group (defined as an endpointIDgroup attribute).

This process makes the endpointIDgroup attribute available for use in creating authorization policy conditions, and allows you to define an authorization policy based on endpoint identity group information using this attribute, in addition to user information.

The condition for the endpoint identity group can be defined in the ID Groups column of the authorization policy configuration page. Conditions that are based on user-related information need to be defined in the “Other Conditions” section of the authorization policy. If user information is based on internal user attributes, then use the ID Group attribute in the internal user dictionary. For example, you can enter the full value path in the identity group using a value like “User Identity Group:Employee:US”.

#### [ISE Community Resource](#)

For an example of how to configure authorization policies in Cisco ISE based on SSIDs, see [ISE Policies Based on SSID Configuration Example](#).

## Time and Date Conditions

Use the Policy Elements Conditions page to display, create, modify, delete, duplicate, and search time and date policy element conditions. Policy elements are shared objects that define a condition that is based on specific time and date attribute settings that you configure.

Time and date conditions let you set or limit permission to access Cisco ISE system resources to specific times and days as directed by the attribute settings you make.

#### Related Topics

[Time and Date Condition Settings](#), on page 1115

[Create Time and Date Conditions](#), on page 558

## Use IPv6 Condition Attributes in Authorization Policies

Cisco ISE can detect, manage, and secure IPv6 traffic from endpoints.

When an IPv6-enabled endpoint connects to the Cisco ISE network, it communicates with the Network Access Device (NAD) over an IPv6 network. The NAD conveys the accounting and profiling information from the endpoint (including IPv6 values) to Cisco ISE over an IPv4 network. You can configure authorization profiles and policies in Cisco ISE using the IPv6 attributes in your rule conditions to process such requests from IPv6-enabled endpoints and ensure that the endpoint is compliant.

You can use wildcard characters in IPv6 prefix and IPv6 interface values. For example: 2001:db8:1234::/48.

Supported IPv6 address formats include:

- Full notation: Eight groups of four hexadecimal digits separated by colons. For example, 2001:0db8:85a3:0000:0000:8a2e:0370:7334
- Shortened notation: Exclude leading zeros in a group; replace groups of zeros with two consecutive colons. For example: 2001:db8:85a3::8a2e:370:7334
- Dotted-quad notation (IPv4-mapped and IPv4 compatible-IPv6 addresses): For example, ::ffff:192.0.2.128

Supported IPv6 attributes include:

- NAS-IPv6-Address
- Framed-Interface-Id
- Framed-IPv6-Prefix
- Login-IPv6-Host
- Framed-IPv6-Route
- Framed-IPv6-Pool
- Delegated-IPv6-Prefix
- Framed-IPv6-Address
- DNS-Server-IPv6-Address
- Route-IPv6-Information
- Delegated-IPv6-Prefix-Pool
- Stateful-IPv6-Address-Pool

The following table lists Supported Cisco Attribute-Value pairs and their equivalent IETF attributes:

| Cisco Attribute-Value Pairs               | IETF Attributes            |
|-------------------------------------------|----------------------------|
| ipv6:addrv6=<ipv6 address>                | Framed-ipv6-Address        |
| ipv6:stateful-ipv6-address-pool=<name>    | Stateful-IPv6-Address-Pool |
| ipv6:delegated-ipv6-pool=<name>           | Delegated-IPv6-Prefix-Pool |
| ipv6:ipv6-dns-servers-addr=<ipv6 address> | DNS-Server-IPv6-Address    |

The RADIUS Live Logs page, RADIUS Authentication report, RADIUS Accounting report, Current Active Session report, RADIUS Error report, Misconfigured NAS report, EPS Audit report, and Misconfigured Supplicant report support IPv6 addresses. You can view the details about these sessions from the RADIUS Live Logs page or from any of these reports. You can filter the records by IPv4, IPv6, or MAC addresses.



**Note** If you connect an Android device to an IPv6 enabled DHCPv6 network, it receives only the link-local IPv6 address from the DHCP server. Hence, global IPv6 address is not displayed in the Live Logs and in the Endpoints page (**Work Centers > Network Access > Identities > Endpoints**).

The following procedure describes how to configure IPv6 attributes in authorization policies.

### Before you begin

Ensure that the NADs in your deployment support AAA with IPv6. See [AAA Support for IPv6](#) for information on how to enable AAA support for IPv6 on your NADs.

- 
- Step 1** Choose **Policy > Authorization > Standard**.
- Step 2** Click the down arrow on the far right and select either **Insert New Rule Above** or **Insert New Rule Below**.
- Step 3** Enter the rule name and specify the condition.  
From the RADIUS dictionary, choose the RADIUS IPv6 attribute, the operator, and the value.
- Step 4** Click **Done**.
- 

## Permissions for Authorization Profiles

Before you start configuring permissions for authorization profiles, make sure you:

- Understand the relationship between authorization policies and profiles.
- Are familiar with the **Authorization Profile** page.
- Know the basic guidelines to follow when configuring policies and profiles.
- Understand what comprises permissions in an authorization profile.

To work with authorization profiles, choose **Policy > Policy Elements > Results**. From the menu on the left, choose **Authorization > Authorization Profiles**.

Use the **Results** navigation pane as your starting point in the process for displaying, creating, modifying, deleting, duplicating, or searching policy element permissions for the different types of authorization profiles on your network. The **Results** pane initially displays Authentication, Authorization, Profiling, Posture, Client Provisioning, and Trustsec options.

Authorization profiles let you choose the attributes to be returned when a RADIUS request is accepted. Cisco ISE provides a mechanism where you can configure **Common Tasks Settings** to support commonly used attributes. You must enter the value for **Common Tasks Attributes**, which Cisco ISE translates to the underlying RADIUS values.

### ISE Community Resource

For an example of how to configure Media Access Control Security (MACsec) encryption between an 802.1x supplicant (Cisco AnyConnect Mobile Security) and an authenticator (switch), see [MACsec Switch-host Encryption with Cisco AnyConnect and ISE Configuration Example](#).

### Related Topics

- [Authorization Policies and Supported Dictionaries](#), on page 600
- [Guidelines for Configuring Authorization Policies and Profiles](#), on page 600
- [Configure Permissions for New Standard Authorization Profiles](#), on page 610
- [Default Authorization Policy, Rule, and Profile Configuration](#), on page 601
- [Default Authorization Rules](#), on page 605

## Configure Permissions for New Standard Authorization Profiles

- 
- Step 1** Choose **Policy > Policy Elements > Results > Authorization > Authorization Profiles**.
- Step 2** Click **Add**.
- Step 3** Enter values as required to configure a new authorization profile. Supported characters for the name field are: space, ! # \$ % & ' ( ) \* + , - . / ; = ? @ \_ { . Once you configure the profile, you can double-check the RADIUS syntax from the **Attributes Details** that dynamically appear at the bottom of the screen.
- Step 4** Click **Submit** to save your changes to the Cisco ISE system database to create an authorization profile.
- 

### Related Topics

[Authorization Profile Settings](#), on page 1129

## Downloadable ACLs

Access control lists (ACLs) are lists of access control entries (ACEs), which may be applied by a Policy Enforcement Point (for example, a switch) to a resource. Each ACE identifies the permissions allowed per user for that object, such as read, write, execute and more. For example, an ACL may be configured for use the Sales area of the network, with an ACE allowing Write permissions for the Sales group and a separate ACE allowing Read permissions for all other employees of the organization. With RADIUS protocol, ACLs grant authorization by filtering source and destination IP addresses, transport protocols, and additional parameters. Static ACLs reside on and are directly configured from the switch and can be applied in your authorization policies from the ISE GUI; downloadable ACLs (DACLs) can be configured, managed and applied in your authorization policies from the ISE GUI.

To implement DACLs in your network authorization policy in ISE:

1. Configure a new or existing DACL from **Policy > Policy Elements > Results > Downloadable ACLs**. For more information see [Configure Permissions for Downloadable ACLs, on page 610](#).
2. Configure a new or existing authorization profile from **Policy > Policy Elements > Results > Authorization Profiles**, using any of the DACLs you already configured.

### Related Topics

[Configure Permissions for Downloadable ACLs](#), on page 610

## Configure Permissions for Downloadable ACLs

With ISE, downloadable ACLs (DACLs) can be configured and implemented in your authorization policies for control of how the network is accessed by different users and groups of users. Default authorization DACLs are available with installation of ISE, including the following default profiles:

- DENY\_ALL\_TRAFFIC
- PERMIT\_ALL\_TRAFFIC

When working with DACLs, these defaults cannot be changed, but you can duplicate them in order to create additional, similar, DACLs.

- 
- Step 1** Choose **Policy > Policy Elements > Results > Authorization > Downloadable ACLs**.
- Step 2** Click **Add** from the top of the **Downloadable ACLs** table or alternatively, choose any of the existing DACLs and click **Duplicate** from the top of the table.
- Step 3** Enter or edit the desired values for the DACL, keeping in mind the following rules:
- Supported characters for the name field are: alphanumeric, hyphen(-), dot( .) and underscore( \_)
  - The keyword **Any** must be the source in all ACEs in the DACL. Once the DACL is pushed, the **Any** in the source is replaced with the IP address of the client that is connecting to the switch.
- Note** The **IP Version** field is noneditable when DACL is mapped to any authorization profile. In this case, remove the DACL reference from **Authorization Profiles**, edit the IP version and remap the DACL in **Authorization Profiles**.
- Step 4** Optionally, when you finish creating the complete list of ACEs, click **Check DACL Syntax** to validate the list. If there are validation errors, the check returns specific instructions identifying the invalid syntax in the window that opens automatically.
- Step 5** Click **Submit**.

---

#### Related Topics

[Configure Permissions for Downloadable ACLs](#), on page 610

## Machine Access Restriction for Active Directory User Authorization

Cisco ISE contains a Machine Access Restriction (MAR) component that provides an additional means of controlling authorization for Microsoft Active Directory-authentication users. This form of authorization is based on the machine authentication of the computer used to access the Cisco ISE network. For every successful machine authentication, Cisco ISE caches the value that was received in the RADIUS Calling-Station-ID attribute (attribute 31) as evidence of a successful machine authentication.

Cisco ISE retains each Calling-Station-ID attribute value in cache until the number of hours that was configured in the “Time to Live” parameter in the Active Directory Settings page expires. Once the parameter has expired, Cisco ISE deletes it from its cache.

When a user authenticates from an end-user client, Cisco ISE searches the cache for a Calling-Station-ID value from successful machine authentications for the Calling-Station-ID value that was received in the user authentication request. If Cisco ISE finds a matching user-authentication Calling-Station-ID value in the cache, this affects how Cisco ISE assigns permissions for the user that requests authentication in the following ways:

- If the Calling-Station-ID value matches one found in the Cisco ISE cache, then the authorization profile for a successful authorization is assigned.
- If the Calling-Station-ID value is not found to match one in the Cisco ISE cache, then the authorization profile for a successful user authentication without machine authentication is assigned.







## CHAPTER 22

# Configure Threat Centric NAC Service

- [Threat Centric NAC Service, on page 613](#)

## Threat Centric NAC Service

Threat Centric Network Access Control (TC-NAC) feature enables you to create authorization policies based on the threat and vulnerability attributes received from the threat and vulnerability adapters. Threat severity levels and vulnerability assessment results can be used to dynamically control the access level of an endpoint or a user.

You can configure the vulnerability and threat adapters to send high fidelity Indications of Compromise (IoC), Threat Detected events, and CVSS scores to Cisco ISE, so that threat-centric access policies can be created to change the privilege and context of an endpoint accordingly.

Cisco ISE supports the following adapters:

- SourceFire FireAMP
- Cognitive Threat Analytics (CTA) adapter
- Qualys



---

**Note** Only the Qualys Enterprise Edition is currently supported for TC-NAC flows.

---

- Rapid7 Nexpose
- Tenable Security Center

When a threat event is detected for an endpoint, you can select the MAC address of the endpoint on the **Compromised Endpoints** window and apply an ANC policy, such as Quarantine. Cisco ISE triggers CoA for that endpoint and applies the corresponding ANC policy. If ANC policy is not available, Cisco ISE triggers CoA for that endpoint and applies the original authorization policy. You can use the **Clear Threat and Vulnerabilities** option on the **Compromised Endpoints** window to clear the threat and vulnerabilities associated with an endpoint (from Cisco ISE system database).

The following attributes are listed under the Threat dictionary:

- CTA-Course\_Of\_Action (values can be Internal Blocking, Eradication, or Monitoring)

- Qualys-CVSS\_Base\_Score
- Qualys-CVSS\_Temporal\_Score
- Rapid7 Nexpose-CVSS\_Base\_Score
- Tenable Security Center-CVSS\_Base\_Score
- Tenable Security Center-CVSS\_Temporal\_Score

The valid range is from 0 to 10 for both Base Score and Temporal Score attributes.

When a vulnerability event is received for an endpoint, Cisco ISE triggers CoA for that endpoint. However, CoA is not triggered when a threat event is received.

You can create an authorization policy by using the vulnerability attributes to automatically quarantine the vulnerable endpoints based on the attribute values. For example:

```
Any Identity Group & Threat:Qualys-CVSS_Base_Score > 7.0 -> Quarantine
```

To view the logs of an endpoint that is automatically quarantined during CoA events, choose **Operations > Threat-Centric NAC Live Logs**. To view the logs of an endpoint that is quarantined manually, choose **Operations > Reports > Audit > Change Configuration Audit**.

Note the following points while enabling the Threat Centric NAC service:

- The Threat Centric NAC service requires a Cisco ISE Apex license.
- Threat Centric NAC service can be enabled on only one node in a deployment.
- You can add only one instance of an adapter per vendor for Vulnerability Assessment service. However, you can add multiple instances of FireAMP adapter.
- You can stop and restart an adapter without losing its configuration. After configuring an adapter, you can stop the adapter at any point of time. The adapter would remain in this state even when the ISE services are restarted. Select the adapter and click **Restart** to start the adapter again.




---

**Note** When an adapter is in Stopped state, you can edit only the name of the adapter instance; you cannot edit the adapter configuration or the advanced settings.

---

You can view the threat information for the endpoints on the following pages:

- **Home page > Threat dashboard**
- **Context Visibility > Endpoints > Compromised Endpoints**

The following alarms are triggered by the Threat Centric NAC service:

- Adapter not reachable (syslog ID: 91002): Indicates that the adapter cannot be reached.
- Adapter Connection Failed (syslog ID: 91018): Indicates that the adapter is reachable but the connection between the adapter and source server is down.
- Adapter Stopped Due to Error (syslog ID: 91006): This alarm is triggered if the adapter is not in the desired state. If this alarm is displayed, check the adapter configuration and server connectivity. Refer to the adapter logs for more details.

- **Adapter Error (syslog ID: 91009):** Indicates that the Qualys adapter is unable to establish a connection with or download information from the Qualys site.

The following reports are available for the Threat Centric NAC service:

- **Adapter Status:** The Adapter Status report displays the status of the threat and vulnerability adapters.
- **COA Events:** When a vulnerability event is received for an endpoint, Cisco ISE triggers CoA for that endpoint. The CoA Events report displays the status of these CoA events. It also displays the old and new authorization rules and the profile details for these endpoints.
- **Threat Events:** The Threat Events report provides a list of all the threat events that Cisco ISE receives from the various adapters that you have configured. Vulnerability Assessment events are not included in this report.
- **Vulnerability Assessment:** The Vulnerability Assessment report provides information about the assessments that are happening for your endpoints. You can view this report to check if the assessment is happening based on the configured policy.

You can view the following information from **Operations > Reports > Diagnostics > ISE Counters > Threshold Counter Trends:**

- Total number of events received
- Total number of threat events
- Total number of vulnerability events
- Total number of CoAs issued (to PSN)

The values for these attributes are collected every 5 minutes, so these values represent the count for the last 5 minutes.

The Threat dashboard contains the following dashlets:

- **Total Compromised Endpoints** dashlet displays the total number of endpoints (both connected and disconnected endpoints) that are currently impacted on the network.
- **Compromised Endpoints Over Time** dashlet displays a historical view of the impact on endpoints for the specified time period.
- **Top Threats** dashlet displays the top threats based on the number of endpoints impacted and the severity of the threat.
- You can use the **Threats Watchlist** dashlet to analyze the trend of selected events.

The size of the bubbles in the **Top Threats** dashlet indicates the number of endpoints impacted and the light shaded area indicates the number of disconnected endpoints. The color as well as the vertical scale indicate the severity of the threat. There are two categories of threat—Indicators and Incidents. The severity attribute for Indicator is "Likely\_Impact" and the severity attribute for Incident is "Impact\_Qualification".

The Compromised Endpoint window displays the matrix view of the endpoints that are impacted and the severity of the impact for each threat category. You can click on the device link to view the detailed threat information for an endpoint.

The Course Of Action chart displays the action taken (Internal Blocking, Eradication, or Monitoring) for the threat incidents based on the CTA-Course\_Of\_Action attribute received from the CTA adapter.

The Vulnerability dashboard on the Home page contains the following dashlets:

- **Total Vulnerable Endpoints** dashlet displays the total number of endpoints that have a CVSS score greater than the specified value. Also displays the total number of connected and disconnected endpoints that have a CVSS score greater than the specified value.
- **Top Vulnerability** dashlet displays the top vulnerabilities based on the number of endpoints impacted or the severity of the vulnerability. The size of the bubbles in the Top Vulnerability dashlet indicates the number of endpoints impacted and the light shaded area indicates the number of disconnected endpoints. The color as well as the vertical scale indicates the severity of the vulnerability.
- You can use the **Vulnerability Watchlist** dashlet to analyze the trend of selected vulnerabilities over a period of time. Click the search icon in the dashlet and enter the vendor-specific id ("qid" for Qualys ID number) to select and view the trend for that particular ID number.
- The **Vulnerable Endpoints Over Time** dashlet displays a historical view of the impact on endpoints over time.

The Endpoint Count By CVSS graph on the **Vulnerable Endpoints** window shows the number of endpoints that are affected and their CVSS scores. You can also view the list of affected endpoints on the **Vulnerable Endpoints** window. You can click the device link to view the detailed vulnerability information for each endpoint.

Threat Centric NAC service logs are included in the support bundle. Threat Centric NAC service logs are located at support/logs/TC-NAC/

## Enable Threat Centric NAC Service

To configure vulnerability and threat adapters, you must first enable the Threat Centric NAC service. This service can be enabled on only one Policy Service Node in your deployment.

### Step 1

### Step 2

Check the check box next to the PSN on which you want to enable the Threat Centric NAC service and click **Edit**.

### Step 3

Check the **Enable Threat Centric NAC Service** check box.

### Step 4

Click **Save**.

### Related Topics

[Add SourceFire FireAMP Adapter](#), on page 616

[Configure Cognitive Threat Analytics Adapter](#), on page 617

[Configure Authorization Profiles for CTA Adapter](#), on page 618

[Configure Authorization Policy using the Course of Action Attribute](#), on page 618

[Threat Centric NAC Service](#), on page 613

## Add SourceFire FireAMP Adapter

### Before you begin

- You must have an account with SourceFire FireAMP.

- You must deploy FireAMP clients on all endpoints.
- You must enable Threat Centric NAC service on the deployment node (see [Enable Threat Centric NAC Service, on page 616](#)).
- FireAMP adapter uses SSL for REST API calls (to the AMP cloud) and AMQP to receive the events. It also supports the use of proxy. FireAMP adapter uses port 443 for communication.

---

**Step 1**

**Step 2** Click **Add**.

**Step 3** Select **AMP : Threat** from the **Vendor** drop-down list.

**Step 4** Enter a name for the adapter instance.

**Step 5** Click **Save**.

**Step 6** Refresh the Vendor Instances listing window. You can configure the adapter only after the adapter status changes to **Ready to Configure** on the Vendor Instances listing window.

**Step 7** Click the **Ready to configure** link.

**Step 8** (Optional) If you have configured a SOCKS proxy server to route all the traffic, enter the hostname and the port number of the proxy server.

**Step 9** Select the cloud to which you want to connect. You can select US cloud or EU cloud.

**Step 10** Select the event source to which you want to subscribe. The following options are available:

- **AMP events only**
- **CTA events only**
- **CTA and AMP events**

**Step 11** Click the FireAMP link and login as admin in FireAMP. Click **Allow** in the **Applications** pane to authorize the Streaming Event Export request.

You will be redirected back to Cisco ISE.

**Step 12** Select the events (for example, suspicious download, connection to suspicious domain, executed malware, java compromise) that you want to monitor.

When you change the advanced settings or reconfigure an adapter, if there are any new events added to the AMP cloud, those events are also listed in the **Events Listing** window.

You can choose a log level for the adapter. The available options are: **Error**, **Info**, and **Debug**.

The summary of the adapter instance configuration will be displayed in the **Configuration Summary** window.

---

## Configure Cognitive Threat Analytics Adapter

### Before you begin

- You must enable Threat Centric NAC service on the deployment node (see [Enable Threat Centric NAC Service, on page 616](#)).


- Log in to Cisco Cognitive Threat Analytics (CTA) portal via <http://cognitive.cisco.com/login> and request CTA STIX/TAXII service. For more information, see [Cisco ScanCenter Administrator Guide](#).
- Cognitive Threat Analytics (CTA) adapter uses TAXII protocol with SSL to poll the CTA cloud for detected threats. It also supports the use of proxy.
- Import the adapter certificate in to the Trusted Certificate Store. Choose **Administration > System > Certificates > Trusted Certificates > Import** to import the certificate.



**Note** CTA works with user identities listed in the web proxy logs as IP addresses or usernames. Specifically, in the case of IP addresses, the IP address of a device that is available through the proxy logs may collide with the IP address of another device on the internal network. For example, roaming users connected via AnyConnect and a split-tunnel directly to the internet could acquire a local IP range address (for example, 10.0.0.X address), which may collide with an address in an overlapping private IP range used in an internal network. We recommend that you take into account the logical network architecture while defining the policies to avoid quarantine actions being applied on mismatched devices.

## Configure Authorization Profiles for CTA Adapter

For each threat event, the CTA adapter returns one of the following values for the Course of Action attribute: Internal Blocking, Monitoring, or Eradication. You can create authorization profiles based on these values.

- 
- Step 1** ChooseIn the Cisco ISE GUI, click the **Menu** icon () and choose **Policy > Policy Elements > Authorization > Authorization Profiles**.
  - Step 2** Click **Add**.
  - Step 3** Enter a name and description for the authorization profile.
  - Step 4** Select the Access Type.
  - Step 5** Enter the required details and click **Submit**.
- 

## Configure Authorization Policy using the Course of Action Attribute

You can use the CTA-Course\_Of\_Action attribute to configure authorization policies for the endpoints for which threat events are reported. This attribute is available in the Threat directory.

You can also create exception rules based on the CTA-Course\_Of\_Action attribute.

- 
- Step 1** The authorization policy page appears. You can edit an existing policy rule or create a new exception rule for the endpoints with threat events.
  - Step 2** Create a condition to check for the CTA-Course\_Of\_Action attribute value and assign the appropriate authorization profile. For example:  

```
Network_Access_Authentication_Passed AND ThreatCTA-Course_Of_Action CONTAINS Internal Blocking then blocking (authorization profile)
```

**Note** "Internal Blocking" is the recommended Course of Action attribute to be used for quarantining the endpoints.

**Step 3** Click **Save**.

---

When a threat event is received for an endpoint, Cisco ISE checks if there is any matching authorization policy for the endpoint and triggers CoA only if the endpoint is active. If the endpoint is offline, threat event details are added to the Threat Events report (Operations > Reports > Threat Centric NAC > Threat Events).



**Note** Sometimes CTA sends multiple risks and their associated Course of Action attributes in one incident. For example, it can send "Internal Blocking" and "Monitoring" (course of action attributes) in one incident. In this case, if you have configured an authorization policy to quarantine endpoints using "equals" operator, the endpoints will not be quarantined. For example:

```
CTA-Course_Of_Action EQUALS Internal Blocking then Quarantine_Systems (authorization profile)
```

In such cases, you must use "contains" operator in the authorization policy to quarantine the endpoints. For example:

```
CTA-Course_Of_Action CONTAINS Internal Blocking then Quarantine_Systems
```

---

## Support for Vulnerability Assessment in Cisco ISE

Cisco ISE integrates with the following Vulnerability Assessment (VA) Ecosystem Partners to obtain vulnerability results of endpoints that connect to the Cisco ISE network:

- **Qualys:** Qualys is a cloud-based assessment system with scanner appliances deployed in the network. Cisco ISE allows you to configure an adapter that communicates with Qualys and obtains the VA results. You can configure the adapter from the Admin portal. You need a Cisco ISE administrator account with Super Admin privileges to configure the adapter. The Qualys adapter uses REST APIs to communicate with the Qualys Cloud Service. You need a user account in Qualys with Manager privileges to access the REST APIs. Cisco ISE uses following Qualys REST APIs:
  - **Host Detection List API:** To check the last scan results of the endpoint
  - **Scan API:** To trigger an on-demand scan of the endpoint

Qualys enforces limits on the number of API calls that subscribed users can make. The default rate limit count is 300 per 24 hours. Cisco ISE uses Qualys API version 2.0 to connect to Qualys. Refer to the Qualys API V2 User Guide for more information on these API functions.

- **Rapid7 Nexpose:** Cisco ISE integrates with Rapid 7 Nexpose, a vulnerability management solution, to help detect vulnerabilities and enables you to respond to such threats quickly. Cisco ISE receives the vulnerability data from Nexpose and based on the policies that you configure in ISE, it quarantines the affected endpoints. From the Cisco ISE dashboard, you can view the affected endpoint and take appropriate action.

Cisco ISE has been tested with Nexpose Release 6.4.1.

- **Tenable SecurityCenter (Nessus scanner):** Cisco ISE integrates with Tenable SecurityCenter and receives the vulnerability data from Tenable Nessus scanner (managed by Tenable SecurityCenter) and based on the policies that you configure in ISE, it quarantines the affected endpoints. From the Cisco ISE dashboard, you can view the affected endpoints and take appropriate action.

Cisco ISE has been tested with Tenable SecurityCenter 5.3.2.

The results from the ecosystem partner are converted in to a Structured Threat Information Expression (STIX) representation and based on this value, a Change of Authorization (CoA) is triggered, if needed, and the appropriate level of access is granted to the endpoint.

The time taken to assess endpoints for vulnerabilities depends on various factors and hence VA cannot be performed in real time. The factors that affect the time taken to assess an endpoint for vulnerabilities include:

- Vulnerability assessment ecosystem
- Type of vulnerabilities scanned for
- Type of scans enabled
- Network and system resources allocated by the ecosystem for the scanner appliances

In this release of Cisco ISE, only endpoints with IPv4 addresses can be assessed for vulnerabilities.

## Enable and Configure Vulnerability Assessment Service

To enable and configure Vulnerability Assessment Service in Cisco ISE, perform the following tasks:

- 
- Step 1** [Enable Threat Centric NAC Service, on page 616.](#)
  - Step 2** To configure:
    - Qualys adapter, see [Configure Qualys Adapter, on page 621.](#)
    - Nexpose adapter, see [Configure Nexpose Adapter, on page 623.](#)
    - Tenable adapter, see [Configure Tenable Adapter, on page 625.](#)
  - Step 3** [Configure Authorization Profile, on page 628.](#)
  - Step 4** [Configure Exception Rule to Quarantine a Vulnerable Endpoint, on page 628.](#)
- 

## Enable Threat Centric NAC Service

To configure vulnerability and threat adapters, you must first enable the Threat Centric NAC service. This service can be enabled on only one Policy Service Node in your deployment.

- 
- Step 1**
  - Step 2** Check the check box next to the PSN on which you want to enable the Threat Centric NAC service and click **Edit**.
  - Step 3** Check the **Enable Threat Centric NAC Service** check box.
  - Step 4** Click **Save**.
- 

### Related Topics

- [Add SourceFire FireAMP Adapter, on page 616](#)
- [Configure Cognitive Threat Analytics Adapter, on page 617](#)
- [Configure Authorization Profiles for CTA Adapter, on page 618](#)



[Configure Authorization Policy using the Course of Action Attribute](#), on page 618  
[Threat Centric NAC Service](#), on page 613

## Configure Qualys Adapter

Cisco ISE supports the Qualys Vulnerability Assessment Ecosystem. You must create a Qualys adapter for Cisco ISE to communicate with Qualys and obtain the VA results.

### Before you begin

- You must have the following user accounts:
  - Admin user account in Cisco ISE with Super Admin privileges to be able to configure a vendor adapter.
  - User account in Qualys with Manager privileges
- Ensure that you have appropriate Qualys license subscriptions. You need access to the Qualys Report Center, Knowledge Base (KBX), and API. Contact your Qualys Account Manager for details.
- Import the Qualys server certificate in to the Trusted Certificates store in Cisco ISE (**Administration > Certificates > Certificate Management > Trusted Certificates > Import**). Ensure that the appropriate root and intermediate certificates are imported (or present) in the Cisco ISE Trusted Certificates store.
- Refer to the Qualys API Guide for the following configurations:
  - Ensure that you have enabled CVSS Scoring in Qualys (**Reports > Setup > CVSS Scoring > Enable CVSS Scoring**).
  - Ensure that you add the IP address and subnet mask of your endpoints in Qualys (**Assets > Host Assets**).
  - Ensure that you have the name of the Qualys option profile. The option profile is the scanner template that Qualys uses for scanning. We recommend that you use an option profile that includes authenticated scans (this option checks the MAC Address of the endpoint as well).
- Cisco ISE communicates with Qualys over HTTPS/SSL (port 443).

---

### Step 1

Click **Add**.

From the **Vendor** drop-down list, choose **Qualys:VA**.

Enter a name for the adapter instance. For example, `Qualys_Instance`.

The listing window appears with a list of configured adapter instances.

Refresh the Vendor Instances listing window. The status for the newly added `Qualys_Instance` adapter should change to **Ready to Configure**.

Click the **Ready to Configure** link.

Enter the following values in the Qualys configuration screen and click **Next**.

| Field Name             | Description                                                                                                      |
|------------------------|------------------------------------------------------------------------------------------------------------------|
| <b>REST API Host</b>   | The hostname of the server that hosts the Qualys cloud. Contact your Qualys representative for this information. |
| <b>REST API Port</b>   | 443                                                                                                              |
| <b>Username</b>        | User account in Qualys with Manager privileges.                                                                  |
| <b>Password</b>        | Password for the Qualys user account.                                                                            |
| <b>HTTP Proxy Host</b> | If you have a proxy server configured to route all Internet traffic, enter the hostname of the proxy server.     |
| <b>HTTP Proxy Port</b> | Enter the port number used by the proxy server.                                                                  |

If the connection to the Qualys server is established, the Scanner Mappings window appears with a list of Qualys scanners. The Qualys scanners from your network appear in this window.

**Step 8** Choose the default scanner that Cisco ISE will use for on-demand scans.

**Step 9** In the **PSN to Scanner Mapping** area, choose one or more Qualys scanner appliance(s) to the PSN node, and click **Next**.

The **Advanced Settings** window appears.

**Step 10** Enter the following values in the **Advanced Settings** window. The settings in this window determine whether an on-demand scan will be triggered or the last scan results will be used for VA.

| Field Name                                                  | Description                                                                                                                                                                                                                                                                                                |
|-------------------------------------------------------------|------------------------------------------------------------------------------------------------------------------------------------------------------------------------------------------------------------------------------------------------------------------------------------------------------------|
| <b>Option Profile</b>                                       | Choose the option profile that you want Qualys to use for scanning the endpoint. You can choose the default option profile, Initial Options.                                                                                                                                                               |
| <b>Last Scan Results - Check Settings</b>                   |                                                                                                                                                                                                                                                                                                            |
| <b>Last scan results check interval in minutes</b>          | (Impacts the access rate of Host Detection List API) Time interval in minutes after which the last scan results must be checked again. Valid range is between 1 and 2880.                                                                                                                                  |
| <b>Maximum results before last scan results are checked</b> | (Impacts the access rate of Host Detection List API) If the number of queued scan requests exceeds the maximum number specified here, the last scan results are checked before the time interval specified in <b>Last scan results check interval in minutes</b> field. Valid range is between 1 and 1000. |
| <b>Verify MAC address</b>                                   | True or False. When set to true, the last scan results from Qualys would be used only if it includes the MAC address of the endpoint.                                                                                                                                                                      |
| <b>Scan Settings</b>                                        |                                                                                                                                                                                                                                                                                                            |
| <b>Scan trigger interval in minutes</b>                     | (Impacts the access rate of Scan API) Time interval in minutes after which an on-demand scan is triggered. Valid range is between 1 and 2880.                                                                                                                                                              |
| <b>Maximum requests before scan is triggered</b>            | (Impacts the access rate of Scan API) If the number of queued scan requests exceeds the maximum number specified here, an on-demand scan would be triggered before the time interval specified in <b>Scan trigger interval in minutes</b> field. Valid range is between 1 and 1000.                        |

| Field Name                                                        | Description                                                                                                                                                                                                                                                                                                                                |
|-------------------------------------------------------------------|--------------------------------------------------------------------------------------------------------------------------------------------------------------------------------------------------------------------------------------------------------------------------------------------------------------------------------------------|
| <b>Scan status check interval in minutes</b>                      | Time interval in minutes after which Cisco ISE communicates with Qualys to check the status of the scan. Valid range is between 1 and 60.                                                                                                                                                                                                  |
| <b>Number of scans that can be triggered concurrently</b>         | (This option depends on the number of scanners you have mapped to each PSN in the Scanner Mappings screen) Each scanner can process only one request at a time. If you have mapped more than one scanner to the PSNs, then you can increment this value based on the number of scanners you have chosen. Valid range is between 1 and 200. |
| <b>Scan timeout in minutes</b>                                    | Time in minutes after which the scan request will time out. If a scan request times out, an alarm is generated. Valid range is between 20 and 1440.                                                                                                                                                                                        |
| <b>Maximum number of IP addresses to be submitted per scanner</b> | Indicates the number of requests that can be queued into a single request to be sent to Qualys for processing. Valid range is between 1 and 1000.                                                                                                                                                                                          |
| <b>Choose the log level for adapter log files</b>                 | Choose a log level for the adapter. The available options are ERROR, INFO, DEBUG, and TRACE.                                                                                                                                                                                                                                               |

**Step 11** Click **Next** to review the Configuration Settings.

**Step 12** Click **Finish**.

## Configure Nexpose Adapter

You must create a Nexpose adapter for Cisco ISE to communicate with Nexpose and obtain the VA results.

### Before you begin

- Ensure that you have enabled the Threat-Centric NAC service in Cisco ISE.
- Log in to Nexpose Security Console and create a user account with the following privileges:
  - Manage sites
  - Create reports
- Import the Nexpose server certificate in to the Trusted Certificates store in Cisco ISE (**Administration > Certificates > Certificate Management > Trusted Certificates > Import**). Ensure that the appropriate root and intermediate certificates are imported (or present) in the Cisco ISE Trusted Certificates store.
- Cisco ISE communicates with Nexpose over HTTPS/SSL (port 3780).

**Step 1**

**Step 2** Click **Add**.

**Step 3** From the **Vendor** drop-down list, choose **Rapid7 Nexpose:VA**.

**Step 4** Enter a name for the adapter instance. For example, Nexpose.

The listing window appears with a list of configured adapter instances.

**Step 5** Refresh the Vendor Instances listing window. The status for the newly added Nexpose adapter should change to **Ready to Configure**.

**Step 6** Click the **Ready to Configure** link.

**Step 7** Enter the following values in the Nexpose configuration screen and click **Next**.

| Field Name      | Description                                                                                                  |
|-----------------|--------------------------------------------------------------------------------------------------------------|
| Nexpose Host    | The hostname of the Nexpose server.                                                                          |
| Nexpose Port    | 3780.                                                                                                        |
| Username        | Nexpose Admin user account.                                                                                  |
| Password        | Password for the Nexpose Admin user account.                                                                 |
| HTTP Proxy Host | If you have a proxy server configured to route all Internet traffic, enter the hostname of the proxy server. |
| HTTP Proxy Port | Enter the port number used by the proxy server.                                                              |

**Step 8** Click **Next** to configure Advanced Settings.

**Step 9** Enter the following values in the **Advanced Settings** window. The settings in this window determine whether an on-demand scan will be triggered or the last scan results will be used for VA.

| Field Name                                                                          | Description                                                                                                                                                                                                                                                     |
|-------------------------------------------------------------------------------------|-----------------------------------------------------------------------------------------------------------------------------------------------------------------------------------------------------------------------------------------------------------------|
| <b>Settings for checking latest scan results</b>                                    |                                                                                                                                                                                                                                                                 |
| <b>Interval between checking the latest scan results in minutes</b>                 | Time interval in minutes after which the last scan results must be checked again. Valid range is between 1 and 2880.                                                                                                                                            |
| <b>Number of pending requests that can trigger checking the latest scan results</b> | If the number of queued scan requests exceeds the maximum number specified here, the last scan results are checked before the time interval specified in Interval between checking the latest scan results in minutes field. Valid range is between 1 and 1000. |
| <b>Verify MAC address</b>                                                           | True or False. When set to true, the last scan results from Nexpose would be used only if it includes the MAC address of the endpoint.                                                                                                                          |
| <b>Scan settings</b>                                                                |                                                                                                                                                                                                                                                                 |
| <b>Scan trigger interval for each site in minutes</b>                               | Time interval in minutes after which a scan is triggered. Valid range is between 1 and 2880.                                                                                                                                                                    |

| Field Name                                                                 | Description                                                                                                                                                                                                               |
|----------------------------------------------------------------------------|---------------------------------------------------------------------------------------------------------------------------------------------------------------------------------------------------------------------------|
| <b>Settings for checking latest scan results</b>                           |                                                                                                                                                                                                                           |
| <b>Number of pending requests before a scan is triggered for each site</b> | If the number of queued scan requests exceeds the maximum number specified here, a scan would be triggered before the time interval specified in <b>Scan timeout in minutes</b> field. Valid range is between 1 and 1000. |
| <b>Scan timeout in minutes</b>                                             | Time in minutes after which the scan request will time out. If a scan request times out, an alarm is generated. Valid range is between 20 and 1440.                                                                       |
| <b>Number of sites for which scans could be triggered concurrently</b>     | The number of sites for which scans can be run concurrently. Valid range is between 1 and 200.                                                                                                                            |
| <b>Timezone</b>                                                            | Choose the time zone based on the time zone that is configured in the Nexpose server.                                                                                                                                     |
| <b>Http timeout in seconds</b>                                             | Time interval in seconds for Cisco ISE to wait for a response from Nexpose. Valid range is between 5 and 1200.                                                                                                            |
| <b>Choose the log level for adapter log files</b>                          | Choose a log level for the adapter. The available options are ERROR, INFO, DEBUG, and TRACE.                                                                                                                              |

**Step 10** Click **Next** to review the Configuration Settings.

**Step 11** Click **Finish**.

## Configure Tenable Adapter

You must create a Tenable adapter for Cisco ISE to communicate with Tenable SecurityCenter (Nessus scanner) and obtain the VA results.

### Before you begin



**Note** You must configure the following in Tenable SecurityCenter before you can configure the Tenable Adapter in Cisco ISE. Refer to Tenable SecurityCenter Documentation for these configurations.

- You must have Tenable Security Center and Tenable Nessus Vulnerability Scanner installed. While registering the Tenable Nessus scanner, ensure that you choose **Managed by SecurityCenter** in the **Registration** field.
- Create a user account with Security Manager privilege in Tenable SecurityCenter.
- Create a repository in SecurityCenter (Log in to Tenable SecurityCenter with Admin credentials and choose **Repository > Add**).
- Add the endpoint IP range to be scanned in the repository.

- Add Nessus scanner.
- Create scan zones and assign IP addresses to the scan zones and scanners that are mapped to these scan zones.
- Create a scan policy for ISE.
- Add an active scan and associate it with the ISE scan policy. Configure settings and targets (IP/DNS names).
- Export System and Root certificates from Tenable SecurityCenter and import it in to the Trusted Certificates store in Cisco ISE (**Administration > Certificates > Certificate Management > Trusted Certificates > Import**). Ensure that the appropriate root and intermediate certificates are imported (or present) in the Cisco ISE Trusted Certificates store.
- Cisco ISE communicates with Tenable SecurityCenter over HTTPS/SSL (port 443).

**Step 1**

**Step 2** Click **Add**.

**Step 3** From the **Vendor** drop-down list, choose **Tenable Security Center:VA**.

**Step 4** Enter a name for the adapter instance. For example, Tenable.

The listing window appears with a list of configured adapter instances.

**Step 5** Refresh the Vendor Instances listing window. The status for the newly added Tenable adapter should change to **Ready to Configure**.

**Step 6** Click the **Ready to Configure** link.

**Step 7** Enter the following values in the Tenable SecurityCenter configuration window and click **Next**.

| Field Name                         | Description                                                                                                  |
|------------------------------------|--------------------------------------------------------------------------------------------------------------|
| <b>Tenable SecurityCenter Host</b> | The hostname of the Tenable SecurityCenter.                                                                  |
| <b>Tenable SecurityCenter Port</b> | 443                                                                                                          |
| <b>Username</b>                    | Username of the user account that has Security Manager privileges in Tenable SecurityCenter.                 |
| <b>Password</b>                    | Password of the user account that has Security Manager privileges in Tenable SecurityCenter.                 |
| <b>HTTP Proxy Host</b>             | If you have a proxy server configured to route all Internet traffic, enter the hostname of the proxy server. |
| <b>HTTP Proxy Port</b>             | Enter the port number used by the proxy server.                                                              |

**Step 8** Click **Next**.

**Step 9** Enter the following values in the **Advanced Settings** window. The settings in this window determine whether an on-demand scan will be triggered or the last scan results will be used for VA.

| Field Name                                                                          | Description                                                                                                                                                                                                                                                                                   |
|-------------------------------------------------------------------------------------|-----------------------------------------------------------------------------------------------------------------------------------------------------------------------------------------------------------------------------------------------------------------------------------------------|
| <b>Repository</b>                                                                   | Choose the repository that you created in Tenable SecurityCenter.                                                                                                                                                                                                                             |
| <b>Scan Policy</b>                                                                  | Choose the scan policy that you have created for ISE in Tenable SecurityCenter.                                                                                                                                                                                                               |
| <b>Settings for checking latest scan results</b>                                    |                                                                                                                                                                                                                                                                                               |
| <b>Interval between checking the latest scan results in minutes</b>                 | Time interval in minutes after which the last scan results must be checked again. Valid range is between 1 and 2880.                                                                                                                                                                          |
| <b>Number of pending requests that can trigger checking the latest scan results</b> | If the number of queued scan requests exceeds the maximum number specified here, the last scan results are checked before the time interval specified in the <b>Interval between checking the latest scan results in minutes</b> field. Valid range is between 1 and 1000. The default is 10. |
| <b>Verify MAC address</b>                                                           | True or False. When set to true, the last scan results from Tenable SecurityCenter would be used only if it includes the MAC address of the endpoint.                                                                                                                                         |
| <b>Scan Settings</b>                                                                |                                                                                                                                                                                                                                                                                               |
| <b>Scan trigger interval for each site in minutes</b>                               | Time interval in minutes after which an on-demand scan is triggered. Valid range is between 1 and 2880.                                                                                                                                                                                       |
| <b>Number of pending requests before a scan is triggered</b>                        | If the number of queued scan requests exceeds the maximum number specified here, an on-demand scan would be triggered before the time interval specified in <b>Scan trigger interval for each site in minutes</b> field. Valid range is between 1 and 1000.                                   |
| <b>Scan timeout in minutes</b>                                                      | Time in minutes after which the scan request times out. If a scan request times out, an alarm is generated. Valid range is between 20 and 1440.                                                                                                                                               |
| <b>Number of scans that could run in parallel</b>                                   | The number of scans that can be run concurrently. Valid range is between 1 and 200.                                                                                                                                                                                                           |
| <b>Http timeout in seconds</b>                                                      | Time interval in seconds for Cisco ISE to wait for a response from Tenable SecurityCenter. Valid range is between 5 and 1200.                                                                                                                                                                 |
| <b>Choose the log level for adapter log files</b>                                   | Choose a log level for the adapter. The available options are ERROR, INFO, DEBUG, and TRACE.                                                                                                                                                                                                  |

**Step 10**

Click **Next** to review the Configuration Settings.

**Step 11**

Click **Finish**.

## Configure Authorization Profile

The authorization profile in Cisco ISE now includes an option to scan endpoints for vulnerabilities. You can choose to run the scan periodically and also specify the time interval for these scans. After you define the authorization profile, you can apply it to an existing authorization policy rule or create a new authorization policy rule.

### Before you begin

You must have enabled the Threat Centric NAC service and configured a vendor adapter.

---

#### Step 1

**Step 2** Create a new authorization profile or edit an existing profile.

**Step 3** From the **Common Tasks** area, check the **Assess Vulnerabilities** check box.

**Step 4** From the **Adapter Instance** drop-down list, choose the vendor adapter that you have configured. For example, Qualys\_Instance.

**Step 5** Enter the scan interval in hours in the Trigger scan if the time since last scan is greater than text box. Valid range is between 1 and 9999.

**Step 6** Check the **Assess periodically using above interval** check box.

**Step 7** Click **Submit**.

---

## Configure Exception Rule to Quarantine a Vulnerable Endpoint

You can use the following Vulnerability Assessment attributes to configure an exception rule and provide limited access to vulnerable endpoints:

- Threat:Qualys-CVSS\_Base\_Score
- Threat:Qualys-CVSS\_Temporal\_Score
- Rapid7 Nexpose-CVSS\_Base\_Score
- Tenable Security Center-CVSS\_Base\_Score
- Tenable Security Center-CVSS\_Temporal\_Score

These attributes are available in the Threat directory. Valid value ranges from 0 to 10.

You can choose to quarantine the endpoint, provide limited access (redirect to a different portal), or reject the request.

---

**Step 1** The authorization policy page appears. You can edit an existing policy rule or create a new exception rule to check for VA attributes.

**Step 2** Create a condition to check for the Qualys score and assign the appropriate authorization profile. For example:  
Any Identity Group & Threat:Qualys-CVSS\_Base\_Score > 5 -> Quarantine (authorization profile)

**Step 3** Click **Save**.

---



## Vulnerability Assessment Logs

Cisco ISE provides the following logs for troubleshooting VA services.

- `vaservice.log`—Contains VA core information and is available in the node that runs the TC-NAC service.
- `varuntime.log`—Contains information about the endpoint and the VA flow; is available in the Monitoring node and the node that runs the TC-NAC service.
- `vaaggregation.log`—Contains hourly aggregation details about the endpoint vulnerability and is available in the Primary Administration Node.





## CHAPTER 23

# Configure Smart Licensing and Smart Call Home Services

---

- [Smart Call Home, on page 631](#)

## Smart Call Home

Smart Call Home (SCH) monitors Cisco ISE devices in your network and notifies you via email about the critical events. Emails contain real-time alerts with environmental information and remediation advice.

When you activate Smart Licensing from Cisco ISE, the SCH capabilities are enabled by default. Otherwise, to enable SCH, you must register Cisco ISE for the SCH service. See [Register for Smart Call Home Service, on page 632](#) for information on how to enable the SCH feature.

After you activate Smart Licensing or register for the SCH service, you can choose to do one of the following:

- Enable only Anonymous Reporting. The Anonymous Reporting feature of SCH provides minimal health information about the Cisco ISE devices in your network.
- Enable the full set of features offered by SCH.

For more information about enabling the SCH capabilities, see [Register for Smart Call Home Service, on page 632](#).

## Smart Call Home Profiles

Smart Call Home profiles determine the types of events that are monitored on your device. Cisco ISE includes the following default profiles:

- ciscotac-1 - Used for anonymous reporting
- isesch-1 - Used for Smart Call Home functionality

You cannot edit the default profile that is used for anonymous reporting (ciscotac-1).

## Anonymous Reporting

Cisco ISE securely collects non-sensitive information about your deployment, network access devices, profiler, and other services that you are using. This data is collected to better understand Cisco ISE usage and to improve the product and the various services that it offers.

By default, anonymous reporting is enabled. If you want to disable anonymous reporting, you can do so from the ISE Admin Portal (Administration > System > Settings > Smart Call Home).

## Register for Smart Call Home Service



**Note** If you have activated Smart Licensing from Cisco ISE, you don't have to register for the Smart Call Home (SCH) service. With Smart Licensing, the SCH capabilities are enabled by default. The Registration Status in the Smart Call Home page would be Active. You can choose to enable only Anonymous Reporting or enable the full set of features offered by SCH.

To enable SCH services without Smart Licensing, you must first register Cisco ISE for the SCH service. You can only do so from a standalone node or a Primary Administration Node.

---

**Step 1** Choose **Administration > System > Settings > Smart Call Home**.

**Step 2** Choose one of the following:

- Turn on full SCH capability
- Keep the default SCH telemetry settings and send only anonymous data
- Disable everything

**Step 3** (Only if you choose the **Turn on full SCH Capability** option) Enter your e-mail address in the Registration Status area.

**Step 4** (Optional) Check the **Transport Gateway** check box and enter the Transport Gateway URL.

**Step 5** Click **Save**.

You will receive an e-mail with the activation link, if you have chosen to turn on full SCH capability. Click the activation link and follow the instructions provided to complete the registration.

---



## CHAPTER 24

# Cisco ISE Endpoint Profiling Policies

- [Cisco ISE Profiling Service, on page 633](#)
- [Configure Profiling Service in Cisco ISE Nodes, on page 636](#)
- [Network Probes Used by Profiling Service, on page 636](#)
- [Configure Probes for Each Cisco ISE Node, on page 646](#)
- [Setup CoA, SNMP RO Community, and Endpoint Attribute Filter, on page 647](#)
- [Attribute Filters for ISE Database Persistence and Performance, on page 650](#)
- [Attributes Collection from Cisco IOS Sensor-Embedded Switches, on page 653](#)
- [Profiler Conditions, on page 655](#)
- [Profiling Network Scan Actions, on page 655](#)
- [Create a Profiler Condition, on page 672](#)
- [Endpoint Profiling Policy Rules, on page 672](#)
- [Create Endpoint Profiling Policies, on page 673](#)
- [Predefined Endpoint Profiling Policies, on page 676](#)
- [Endpoint Profiling Policies Grouped into Logical Profiles, on page 679](#)
- [Profiling Exception Actions, on page 680](#)
- [Create Endpoints with Static Assignments of Policies and Identity Groups, on page 681](#)
- [Identified Endpoints, on page 685](#)
- [Create Endpoint Identity Groups, on page 687](#)
- [Profiler Feed Service, on page 689](#)
- [Profiler Reports, on page 693](#)
- [Detect Anomalous Behavior of Endpoints , on page 693](#)
- [Cisco ISE Integration with Cisco NAC Appliance, on page 695](#)
- [Create Endpoints with Static Assignments of Policies and Identity Groups, on page 697](#)
- [Identified Endpoints, on page 701](#)
- [Anycast and Profiler Services, on page 705](#)

## Cisco ISE Profiling Service

The profiling service in Cisco Identity Services Engine (ISE) identifies the devices that connect to your network and their location. The endpoints are profiled based on the endpoint profiling policies configured in Cisco ISE. Cisco ISE then grants permission to the endpoints to access the resources in your network based on the result of the policy evaluation.

The profiling service:

- Facilitates an efficient and effective deployment and ongoing management of authentication by using IEEE standard 802.1X port-based authentication access control, MAC Authentication Bypass (MAB) authentication, and Network Admission Control (NAC) for any enterprise network of varying scale and complexity.
- Identifies, locates, and determines the capabilities of all of the attached network endpoints regardless of endpoint types.
- Protects against inadvertently denying access to some endpoints.

#### [ISE Community Resource](#)

[ISE Endpoint Profiles](#)

[How To: ISE Profiling Design Guide](#)

## Profiler Work Center

The Profiler Work Center menu (Work Centers > Profiler) contains all the profiler pages, which acts as a single start point for ISE administrators. The Profiler Work Center menu contains the following options: Overview, Ext ID Stores, Network Devices, Endpoint Classification, Node Config, Feeds, Manual Scans, Policy Elements, Profiling Policies, Authorization Policy, Troubleshoot, Reports, Settings, and Dictionaries.

## Profiler Dashboard

The Profiler dashboard (Work Centers > Profiler > Endpoint Classification) is a centralized monitoring tool for the profiles, endpoints, and assets in your network. The dashboard represents data in both graphical and table formats. The Profiles dashlet displays the logical and endpoint profiles that are currently active in the network. The Endpoints dashlet displays the identity group, PSNs, OS types of the endpoints that connect to your network. The Assets dashlet displays flows such as Guest, BYOD, and Corporate. The table displays the various endpoints that are connected and you can also add new endpoints.

## Endpoint Inventory Using Profiling Service

You can use the profiling service to discover, locate, and determine the capabilities of all the endpoints connected to your network. You can ensure and maintain appropriate access of endpoints to the enterprise network, regardless of their device types.

The profiling service collects attributes of endpoints from the network devices and the network, classifies endpoints into a specific group according to their profiles, and stores endpoints with their matched profiles in the Cisco ISE database. All the attributes that are handled by the profiling service need to be defined in the profiler dictionaries.

The profiling service identifies each endpoint on your network, and groups those endpoints according to their profiles to an existing endpoint identity group in the system, or to a new group that you can create in the system. By grouping endpoints, and applying endpoint profiling policies to the endpoint identity group, you can determine the mapping of endpoints to the corresponding endpoint profiling policies.

## Cisco ISE Profiler Queue Limit Configuration

Cisco ISE profiler collects a significant amount of endpoint data from the network in a short period of time. It causes Java Virtual Machine (JVM) memory utilization to go up due to accumulated backlog when some of the slower Cisco ISE components process the data generated by the profiler, which results in performance degradation and stability issues.

To ensure that the profiler does not increase the JVM memory utilization and prevent JVM to go out of memory and restart, limits are applied to the following internal components of the profiler:

- **Endpoint Cache:** Internal cache is limited in size that has to be purged periodically (based on least recently used strategy) when the size exceeds the limit.
- **Forwarder:** The main ingress queue of endpoint information collected by the profiler.
- **Event Handler:** An internal queue that disconnects a fast component, which feeds data to a slower processing component (typically related to a database query).

### Endpoint Cache

- `maxEndPointsInLocalDb = 100000` (endpoint objects in cache)
- `endPointsPurgeIntervalSec = 300` (endpoint cache purge thread interval in seconds)
- `numberOfProfilingThreads = 8` (number of threads)

The limit is applicable to all profiler internal event handlers. A monitoring alarm is triggered when queue size limit is reached.

### Cisco ISE Profiler Queue Size Limits

- `forwarderQueueSize = 5000` (endpoint collection events)
- `eventHandlerQueueSize = 10000` (events)

### Event Handlers

- **NetworkDeviceEventHandler:** For network device events, in addition to filtering duplicate Network Access Device (NAD) IP addresses, which are already cached.
- **ARPCacheEventHandler:** For ARP Cache events.

## Martian IP Addresses

Martian IP addresses are not displayed in **Context Visibility > Endpoints** and **Work Centers > Profiler > Endpoint Classification** windows as the RADIUS parser removes such addresses before they reach the profiling service. Martian IP addresses are a security concern as they are vulnerable to attacks. However, martian IP addresses are displayed in MnT logs for auditing purposes. This behaviour stands true in the case of multicast IP addresses as well. For more information on Martian IP addresses, see [https://www.cisco.com/assets/sol/sb/Switches\\_Emulators\\_v2\\_3\\_5\\_xx/help/250/index.html#page/tesla\\_250\\_olh/martian\\_addresses.html](https://www.cisco.com/assets/sol/sb/Switches_Emulators_v2_3_5_xx/help/250/index.html#page/tesla_250_olh/martian_addresses.html)

## Configure Profiling Service in Cisco ISE Nodes

You can configure the profiling service that provides you a contextual inventory of all the endpoints that are using your network resources in any Cisco ISE-enabled network.

You can configure the profiling service to run on a single Cisco ISE node that assumes all Administration, Monitoring, and Policy Service personas by default.

In a distributed deployment, the profiling service runs only on Cisco ISE nodes that assume the Policy Service persona and does not run on other Cisco ISE nodes that assume the Administration and Monitoring personas.

---

### Step 1

**Step 2** Choose a Cisco ISE node that assumes the Policy Service persona.

**Step 3** Click **Edit** in the Deployment Nodes page.

**Step 4** On the **General Settings** tab, check the **Policy Service** check box. If the Policy Service check box is unchecked, both the session services and the profiling service check boxes are disabled.

**Step 5** Perform the following tasks:

- a) Check the **Enable Session Services** check box to run the Network Access, Posture, Guest, and Client Provisioning session services.
- b) Check the **Enable Profiling Services** check box to run the profiling service.
- c) Check the **Enable Device Admin Service** check box to run the device administration service to control and audit an enterprise's network devices.

**Step 6** Click **Save** to save the node configuration.

---

## Network Probes Used by Profiling Service

Network probe is a method used to collect an attribute or a set of attributes from an endpoint on your network. The probe allows you to create or update endpoints with their matched profile in the Cisco ISE database.

Cisco ISE can profile devices using a number of network probes that analyze the behavior of devices on the network and determine the type of the device. Network probes help you to gain more network visibility.

## IP Address and MAC Address Binding

You can create or update endpoints only by using their MAC addresses in an enterprise network. If you do not find an entry in the ARP cache, then you can create or update endpoints by using the L2 MAC address of an HTTP packet and the IN\_SRC\_MAC of a NetFlow packet in Cisco ISE. The profiling service is dependent on L2 adjacency when endpoints are only a hop away. When endpoints are L2 adjacent, the IP addresses and MAC addresses of endpoints are already mapped, and there is no need for IP-MAC cache mapping.

If endpoints are not L2 adjacent and are multiple hops away, mapping may not be reliable. Some of the known attributes of NetFlow packets that you collect include PROTOCOL, L4\_SRC\_PORT, IPV4\_SRC\_ADDR, L4\_DST\_PORT, IPV4\_DST\_ADDR, IN\_SRC\_MAC, OUT\_DST\_MAC, IN\_SRC\_MAC, and OUT\_SRC\_MAC. When endpoints are not L2 adjacent and are multiple L3 hops away, the IN\_SRC\_MAC attributes carry only the MAC addresses of L3 network devices. When the HTTP probe is enabled in Cisco



ISE, you can create endpoints only by using the MAC addresses of HTTP packets, because the HTTP request messages do not carry IP addresses and MAC addresses of endpoints in the payload data.

Cisco ISE implements an ARP cache in the profiling service, so that you can reliably map the IP addresses and the MAC addresses of endpoints. For the ARP cache to function, you must enable either the DHCP probe or the RADIUS probe. The DHCP and RADIUS probes carry the IP addresses and the MAC addresses of endpoints in the payload data. The `dhcp-requested-address` attribute in the DHCP probe and the `Framed-IP-address` attribute in the RADIUS probe carry the IP addresses of endpoints, along with their MAC addresses, which can be mapped and stored in the ARP cache.

## NetFlow Probe

Cisco ISE profiler implements Cisco IOS NetFlow Version 9. We recommend using NetFlow Version 9, which has additional functionality needed to enhance the profiler to support the Cisco ISE profiling service.

You can collect NetFlow Version 9 attributes from the NetFlow-enabled network access devices to create an endpoint, or update an existing endpoint in the Cisco ISE database. You can configure NetFlow Version 9 to attach the source and destination MAC addresses of endpoints and update them. You can also create a dictionary of NetFlow attributes to support NetFlow-based profiling.

For more information on the NetFlow Version 9 Record Format, see Table 6, “NetFlow Version 9 Field Type Definitions” of the NetFlow Version 9 Flow-Record Format document.

In addition, Cisco ISE supports NetFlow versions earlier than Version 5. If you use NetFlow Version 5 in your network, then you can use Version 5 only on the primary network access device (NAD) at the access layer because it will not work anywhere else.

Cisco IOS NetFlow Version 5 packets do not contain MAC addresses of endpoints. The attributes that are collected from NetFlow Version 5 cannot be directly added to the Cisco ISE database. You can discover endpoints by using their IP addresses, and append the NetFlow Version 5 attributes to endpoints, which can be done by combining IP addresses of the network access devices and IP addresses obtained from the NetFlow Version 5 attributes. However, these endpoints must have been previously discovered with the RADIUS or SNMP probe.

The MAC address is not a part of IP flows in earlier versions of NetFlow Version 5, which requires you to profile endpoints with their IP addresses by correlating the attributes information collected from the network access devices in the endpoints cache.

For more information on the NetFlow Version 5 Record Format, see Table 2, “Cisco IOS NetFlow Flow Record and Export Format Content Information” of the NetFlow Services Solutions Guide.

## DHCP Probe

The Dynamic Host Configuration Protocol probe in your Cisco ISE deployment allows the Cisco ISE profiling service to reprofile endpoints based only on new requests of INIT-REBOOT and SELECTING message types. Though other DHCP message types such as RENEWING and REBINDING are processed, they are not used for profiling endpoints. Any attribute parsed out of DHCP packets is mapped to endpoint attributes.

### DHCPREQUEST Message Generated During INIT-REBOOT State

If the DHCP client checks to verify a previously allocated and cached configuration, then the client must not fill in the Server identifier (`server-ip`) option. Instead it should fill in the Requested IP address (`requested-ip`) option with the previously assigned IP address, and fill in the Client IP Address (`ciaddr`) field with zero in its

DHCPREQUEST message. The DHCP server will then send a DHCPNAK message to the client if the Requested IP address is incorrect or the client is located in the wrong network.

### DHCPREQUEST Message Generated During SELECTING State

The DHCP client inserts the IP address of the selected DHCP server in the Server identifier (server-ip) option, fills in the Requested IP address (requested-ip) option with the value of the Your IP Address (yiaddr) field from the chosen DHCP OFFER by the client, and fills in the “ciaddr” field with zero.

*Table 45: DHCP Client Messages from Different States*

| —                 | INIT-REBOOT | SELECTING | RENEWING   | REBINDING  |
|-------------------|-------------|-----------|------------|------------|
| broadcast/unicast | broadcast   | broadcast | unicast    | broadcast  |
| server-ip         | MUST NOT    | MUST      | MUST NOT   | MUST NOT   |
| requested-ip      | MUST        | MUST      | MUST NOT   | MUST NOT   |
| ciaddr            | zero        | zero      | IP address | IP address |

## Wireless LAN Controller Configuration in DHCP Bridging Mode

We recommend that you configure wireless LAN controllers (WLCs) in Dynamic Host Configuration Protocol (DHCP) bridging mode, where you can forward all the DHCP packets from the wireless clients to Cisco ISE. You must uncheck the Enable DHCP Proxy check box available in the WLC web interface: **Controller > Advanced > DHCP Master Controller Mode > DHCP Parameters**. You must also ensure that the DHCP IP helper command points to the Cisco ISE Policy Service node.

## DHCP SPAN Probe

The DHCP Switched Port Analyzer (SPAN) probe, when initialized in a Cisco ISE node, listens to network traffic, which are coming from network access devices on a specific interface. You need to configure network access devices to forward DHCP SPAN packets to the Cisco ISE profiler from the DHCP servers. The profiler receives these DHCP SPAN packets and parses them to capture the attributes of an endpoint, which can be used for profiling endpoints.

For example,

```
switch(config)# monitor session 1 source interface Gi1/0/4
switch(config)# monitor session 1 destination interface Gi1/0/2
```

## HTTP Probe

In HTTP probe, the identification string is transmitted in an HTTP request-header field User-Agent, which is an attribute that can be used to create a profiling condition of IP type, and to check the web browser information. The profiler captures the web browser information from the User-Agent attribute along with other HTTP attributes from the request messages, and adds them to the list of endpoint attributes.

Cisco ISE listens to communication from the web browsers on both port 80 and port 8080. Cisco ISE provides many default profiles, which are built in to the system to identify endpoints based on the User-Agent attribute.

HTTP probe is enabled by default. Multiple ISE services such as CWA, Hotspot, BYOD, MDM, and Posture rely on URL-redirection of the client's web browser. The redirected traffic includes the RADIUS session ID of the connected endpoint. When a PSN terminates these URL-redirectioned flows, it has visibility into the decrypted HTTPS data. Even when the HTTP probe is disabled on the PSN, the node will parse the browser user agent string from the web traffic and correlate the data to the endpoint based on its associated session ID. When browser strings are collected through this method, the source of the data is listed as Guest Portal or CP (Client Provisioning) rather than HTTP Probe.

## HTTP SPAN Probe

The HTTP probe in your Cisco ISE deployment, when enabled with the Switched Port Analyzer (SPAN) probe, allows the profiler to capture HTTP packets from the specified interfaces. You can use the SPAN capability on port 80, where the Cisco ISE server listens to communication from the web browsers.

HTTP SPAN collects HTTP attributes of an HTTP request-header message along with the IP addresses in the IP header (L3 header), which can be associated to an endpoint based on the MAC address of an endpoint in the L2 header. This information is useful for identifying different mobile and portable IP-enabled devices such as Apple devices, and computers with different operating systems. Identifying different mobile and portable IP-enabled devices is made more reliable because the Cisco ISE server redirects captures during a guest login or client provisioning download. This allows the profiler to collect the User-Agent attribute and other HTTP attributes, from the request messages and then identify devices such as Apple devices.

## Unable to Collect HTTP Attributes in Cisco ISE Running on VMware

If you deploy Cisco ISE on an ESX server (VMware), the Cisco ISE profiler collects the Dynamic Host Configuration Protocol traffic but does not collect the HTTP traffic due to configuration issues on the vSphere client. To collect HTTP traffic on a VMware setup, configure the security settings by changing the Promiscuous Mode to Accept from Reject (by default) of the virtual switch that you create for the Cisco ISE profiler. When the Switched Port Analyzer (SPAN) probe for DHCP and HTTP is enabled, Cisco ISE profiler collects both the DHCP and HTTP traffic.

## pxGrid Probe

The pxGrid probe leverages Cisco pxGrid for receiving endpoint context from external sources. Prior to Cisco ISE 2.4, Cisco ISE served only as a publisher and shared various context information such as session identity and group information as well as configuration elements to external subscribers. With the introduction of the pxGrid probe in Cisco ISE 2.4, other solutions serve as the publishers and Cisco ISE Policy Service nodes become the subscribers.

The pxGrid probe is based on pxGrid v2 specification using the Endpoint Asset topic */topic/com.cisco.endpoint.asset* with Service Name *com.cisco.endpoint.asset*. The following table displays the topic attributes all of which are preceded by the prefix *asset*.

**Table 46: Endpoint Asset Topic**

| Attribute Name        | Type   | Description |
|-----------------------|--------|-------------|
| <b>assetId</b>        | Long   | Asset ID    |
| <b>assetName</b>      | String | Asset name  |
| <b>assetIpAddress</b> | String | IP address  |

|                              |        |                                  |
|------------------------------|--------|----------------------------------|
| <b>assetMacAddress</b>       | String | MAC address                      |
| <b>assetVendor</b>           | String | Manufacturer                     |
| <b>assetProductId</b>        | String | Product Code                     |
| <b>assetSerialNumber</b>     | String | Serial Number                    |
| <b>assetDeviceType</b>       | String | Device Type                      |
| <b>assetSwRevision</b>       | String | S/W Revision number              |
| <b>assetHwRevision</b>       | String | H/W Revision number              |
| <b>assetProtocol</b>         | String | Protocol                         |
| <b>assetConnectedLinks</b>   | Array  | Array of Network Link objects    |
| <b>assetCustomAttributes</b> | Array  | Array of Custom name-value pairs |

In addition to the attributes commonly used to track networked assets such as device MAC address (`assetMacAddress`) and IP address (`assetIpAddress`), the topic allows vendors to publish unique endpoint information as Custom Attributes (`assetCustomAttributes`). The use of Endpoint Custom Attributes in Cisco ISE makes the topic extensible to a variety of use cases without requiring schema updates for each new set of unique vendor attributes shared over pxGrid.

## RADIUS Probe

You can configure Cisco ISE for authentication with RADIUS, where you can define a shared secret that you can use in client-server transactions. With the RADIUS request and response messages that are received from the RADIUS servers, the profiler can collect RADIUS attributes, which can be used for profiling endpoints.

Cisco ISE can function as a RADIUS server, and a RADIUS proxy client to other RADIUS servers. When it acts as a proxy client, it uses external RADIUS servers to process RADIUS requests and response messages.

The RADIUS probe also collects attributes sent in RADIUS accounting packets by device sensors. For more information, see [Attributes Collection from Cisco IOS Sensor-Embedded Switches, on page 653](#) and [Configuration Checklist for Cisco IOS Sensor-Enabled Network Access Devices, on page 653](#).

The RADIUS probe is running by default, even for systems not configured for Profiling Service to ensure ISE can track endpoint authentication and authorization details for use in Context Visibility Services. The RADIUS probe and Profiling Services are also used to track the creation and update times for registered endpoints for purposes of purge operations.

**Table 47: Common Attributes Collected Using the RADIUS Probe**

| User Name         | Calling Station ID | Called Station ID     | Framed IP Address    |
|-------------------|--------------------|-----------------------|----------------------|
| NAS-IP-Address    | NAS-Port-Type      | NAS-Port-Id           | NAS-Identifier       |
| Device Type (NAD) | Location (NAD)     | Authentication Policy | Authorization Policy |



**Note** When an accounting stop is received, it triggers the Cisco ISE to reprofile the corresponding endpoint if it was originally profiled with an IP address. Therefore if you have custom profiles for endpoints profiled with IP addresses, the only way to meet the total certainty factor for these profiles is to match on the corresponding IP address.

## Network Scan (NMAP) Probe

Cisco ISE enables you to detect devices in a subnet by using the NMAP security scanner. You enable the NMAP probe on the Policy Service node that is enabled to run the profiling service. You use the results from that probe in an endpoint profiling policy.

Each NMAP manual subnet scan has a unique numeric ID that is used to update an endpoint source information with that scan ID. Upon detection of endpoints, the endpoint source information can also be updated to indicate that it is discovered by the Network Scan probe.

The NMAP manual subnet scan is useful for detecting devices such as printers with a static IP address assigned to them that are connected constantly to the Cisco ISE network, and therefore these devices cannot be discovered by other probes.

### NMAP Scan Limitations

Scanning a subnet is highly resource intensive. Scanning a subnet is lengthy process that depends on the size and density of the subnet. Number of active scans is always restricted to one scan, which means that you can scan only a single subnet at a time. You can cancel a subnet scan at any time while the subnet scan is in progress. You can use the **Click** to see latest scan results link to view the most recent network scan results that are stored in **Work Centers > Profiler > Manual Scans > Manual NMAP Scan Results**.

### Manual NMAP Scan

The following NMAP command scans a subnet and sends the output to nmapSubnet.log:

```
nmap -O -sU -p U:161,162 -oN /opt/CSCOcsm/logs/nmapSubnet.log
--append-output -oX - <subnet>
```

**Table 48: NMAP Commands for a Manual Subnet Scan**

|                  |                                                     |
|------------------|-----------------------------------------------------|
| -O               | Enables OS detection                                |
| -sU              | UDP scan                                            |
| -p <port ranges> | Scans only specified ports. For example, U:161, 162 |
| oN               | Normal output                                       |
| oX               | XML output                                          |

## SNMP Read Only Community Strings for NMAP Manual Subnet Scan

The NMAP manual subnet scan is augmented with an SNMP Query whenever the scan discovers that UDP port 161 is open on an endpoint that results in more attributes being collected. During the NMAP manual subnet scan, the Network Scan probe detects whether SNMP port 161 is open on the device. If the port is open, an SNMP Query is triggered with a default community string (public) with SNMP version 2c.

If the device supports SNMP and the default Read Only community string is set to public, you can obtain the MAC address of the device from the MIB value “ifPhysAddress”.

In addition, you can configure additional SNMP Read Only community strings separated by a comma for the NMAP manual network scan in the **Profiler Configuration** window. You can also specify new Read Only community strings for an SNMP MIB walk with SNMP versions 1 and 2c. For information on configuring SNMP Read Only community strings, see [Setup CoA, SNMP RO Community, and Endpoint Attribute Filter, on page 647](#).

## Manual NMAP Scan Results

The most recent network scan results are stored in Work Centers > Profiler > Manual Scans > Manual NMAP Scan Results. The Manual NMAP Scan Results page displays only the most recent endpoints that are detected, along with their associated endpoint profiles, their MAC addresses, and their static assignment status as the result of a manual network scan you perform on any subnet. This page allows you to edit points that are detected from the endpoint subnet for better classification, if required.

Cisco ISE allows you to perform the manual network scan from the Policy Service nodes that are enabled to run the profiling service. You must choose the Policy Service node from the primary Administration ISE node user interface in your deployment to run the manual network scan from the Policy Service node. During the manual network scan on any subnet, the Network Scan probe detects endpoints on the specified subnet, their operating systems, and check UDP ports 161 and 162 for an SNMP service.

Given below is additional information related to the manual NMAP scan results:

- To detect unknown endpoints, NMAP should be able to learn the IP/MAC binding via NMAP or a supporting SNMP scan.
- ISE learns IP/MAC binding of known endpoints via Radius authentication or DHCP profiling.
- The IP/MAC bindings are not replicated across PSN nodes in a deployment. Therefore, you must trigger the manual scan from the PSN, which has the IP/MAC binding in its local database (for example, the PSN against which a mac address was last authenticated with).
- The NMAP scan results do not display any information related to an endpoint that NMAP had previously scanned, manually or automatically.

### Additional Information

Given below is additional information related to the manual NMAP scan results:

- To detect unknown endpoints, NMAP should be able to learn the IP/MAC binding via NMAP or a supporting SNMP scan.
- ISE learns IP/MAC binding of known endpoints via Radius authentication or DHCP profiling.
- The IP/MAC bindings are not replicated across PSN nodes in a deployment. Therefore, you must trigger the manual scan from the PSN, which has the IP/MAC binding in its local database (for example, the PSN against which a mac address was last authenticated with).
- The NMAP scan results do not display any information related to an endpoint that NMAP had previously scanned, manually or automatically.

## DNS Probe

The Domain Name Service (DNS) probe in your Cisco ISE deployment allows the profiler to lookup an endpoint and get the fully qualified domain name (FQDN). After an endpoint is detected in your Cisco ISE-enabled network, a list of endpoint attributes is collected from the NetFlow, DHCP, DHCP SPAN, HTTP, RADIUS, or SNMP probes.

When you deploy Cisco ISE in a standalone or in a distributed environment for the first time, you are prompted to run the setup utility to configure the Cisco ISE appliance. When you run the setup utility, you will configure the Domain Name System (DNS) domain and the primary nameserver (primary DNS server), where you can configure one or more nameservers during setup. You can also change or add DNS nameservers later after deploying Cisco ISE using the CLI commands.

## DNS FQDN Lookup

Before a DNS lookup can be performed, one of the following probes must be started along with the DNS probe: DHCP, DHCP SPAN, HTTP, RADIUS, or SNMP. This allows the DNS probe in the profiler to do a reverse DNS lookup (FQDN lookup) against specified name servers that you define in your Cisco ISE deployment. A new attribute is added to the attribute list for an endpoint, which can be used for an endpoint profiling policy evaluation. The FQDN is the new attribute that exists in the system IP dictionary. You can create an endpoint profiling condition to validate the FQDN attribute and its value for profiling. The following are the specific endpoint attributes that are required for a DNS lookup and the probe that collects these attributes:

- The dhcp-requested-address attribute—An attribute collected by the DHCP and DHCP SPAN probes.
- The SourceIP attribute—An attribute collected by the HTTP probe
- The Framed-IP-Address attribute—An attribute collected by the RADIUS probe
- The cdpCacheAddress attribute—An attribute collected by the SNMP probe

## Configure Call Station ID Type in the WLC Web Interface

You can use the WLC web interface to configure Call Station ID Type information. You can go to the Security tab of the WLC web interface to configure the calling station ID in the RADIUS Authentication Servers page. The MAC Delimiter field is set to Colon by default in the WLC user interface.

For more information on how to configure in the WLC web interface, see Chapter 6, “Configuring Security Solutions” in the Cisco Wireless LAN Controller Configuration Guide, Release 7.2.

For more information on how to configure in the WLC CLI using the config radius callStationIdType command, see Chapter 2, “Controller Commands” in the Cisco Wireless LAN Controller Command Reference Guide, Release 7.2.

- 
- Step 1** Log in to your Wireless LAN Controller user interface.
  - Step 2** Click **Security**.
  - Step 3** Expand **AAA**, and then choose **RADIUS > Authentication**.
  - Step 4** Choose **System MAC Address** from the Call Station ID Type drop-down list.
  - Step 5** Check the **AES Key Wrap** check box when you run Cisco ISE in FIPS mode.

**Step 6** Choose **Colon** from the MAC Delimiter drop-down list.

## SNMP Query Probe

In addition to configuring the SNMP Query probe in the Edit Node page, you must configure other Simple Management Protocol settings in the following location: **Administration > Network Resources > Network Devices**.

You can configure SNMP settings in the new network access devices (NADs) in the Network Devices list page. The polling interval that you specify in the SNMP query probe or in the SNMP settings in the network access devices query NADs at regular intervals.

You can turn on and turn off SNMP querying for specific NADs based on the following configurations:

- SNMP query on Link up and New MAC notification turned on or turned off
- SNMP query on Link up and New MAC notification turned on or turned off for Cisco Discovery Protocol information
- SNMP query timer for once an hour for each switch by default

For an iDevice, and other mobile devices that do not support SNMP, the MAC address can be discovered by the ARP table, which can be queried from the network access device by an SNMP Query probe.

## Cisco Discovery Protocol Support with SNMP Query

When you configure SNMP settings on the network devices, you must ensure that the Cisco Discovery Protocol is enabled (by default) on all the ports of the network devices. If you disable the Cisco Discovery Protocol on any of the ports on the network devices, then you may not be able to profile properly because you will miss the Cisco Discovery Protocol information of all the connected endpoints. You can enable the Cisco Discovery Protocol globally by using the `cdp run` command on a network device, and enable the Cisco Discovery Protocol by using the `cdp enable` command on any interface of the network access device. To disable the Cisco Discovery Protocol on the network device and on the interface, use the `no` keyword at the beginning of the commands.

## Link Layer Discovery Protocol Support with SNMP Query

The Cisco ISE profiler uses an SNMP Query to collect LLDP attributes. You can also collect LLDP attributes from a Cisco IOS sensor, which is embedded in the network device, by using the RADIUS probe. The following are the default LLDP configuration settings that you can use to configure LLDP global configuration and LLDP interface configuration commands on the network access devices.

*Table 49: Default LLDP Configuration*

| Attribute                            | Setting     |
|--------------------------------------|-------------|
| LLDP global state                    | Disabled    |
| LLDP holdtime (before discarding)    | 120 seconds |
| LLDP timer (packet update frequency) | 30 seconds  |
| LLDP reinitialization delay          | 2 seconds   |



| Attribute            | Setting                               |
|----------------------|---------------------------------------|
| LLDP tlv-select      | Enabled to send and receive all TLVs. |
| LLDP interface state | Enabled                               |
| LLDP receive         | Enabled                               |
| LLDP transmit        | Enabled                               |
| LLDP med-tnv-select  | Enabled to send all LLDP-MED TLVs     |

### CDP and LLDP Capability Codes Displayed in a Single Character

The Attribute List of an endpoint displays a single character value for the `lldpCacheCapabilities` and `lldpCapabilitiesMapSupported` attributes. The values are the Capability Codes that are displayed for the network access device that runs CDP and LLDP.

#### Example 1

```
lldpCacheCapabilities S
lldpCapabilitiesMapSupported S
```

#### Example 2

```
lldpCacheCapabilities B;T
lldpCapabilitiesMapSupported B;T
```

#### Example 3

```
Switch#show cdp neighbors
Capability Codes:
R - Router, T - Trans Bridge, B - Source Route Bridge, S - Switch, H - Host, I - IGMP,
r - Repeater, P - Phone, D - Remote, C - CVTA, M - Two-port Mac Relay
...
Switch#

Switch#show lldp neighbors
Capability codes:
(R) Router, (B) Bridge, (T) Telephone, (C) DOCSIS Cable Device
(W) WLAN Access Point, (P) Repeater, (S) Station, (O) Other
...
Switch#
```

## SNMP Trap Probe

The SNMP Trap receives information from the specific network access devices that support MAC notification, linkup, linkdown, and informs. The SNMP Trap probe receives information from the specific network access devices when ports come up or go down and endpoints disconnect from or connect to your network.

For SNMP Trap to be fully functional and create endpoints, you must enable SNMP Query so that the SNMP Query probe triggers a poll event on the particular port of the network access device when a trap is received. To make this feature fully functional, you should configure the network access device and SNMP Trap.



**Note** Cisco ISE does not support SNMP Traps that are received from the Wireless LAN Controllers (WLCs) and Access Points (APs).

## Active Directory Probe

The Active Directory (AD) probe:

- Improves the fidelity of OS information for Windows endpoints. Microsoft AD tracks detailed OS information for AD-joined computers including version and service pack levels. The AD probe retrieves this information directly using the AD Runtime connector to provide a highly reliable source of client OS information.
- Helps distinguish between corporate and non-corporate assets. A basic but important attribute available to the AD probe is whether an endpoint exists in AD. This information can be used to classify an endpoint contained in the AD as a managed device or corporate asset.

You can enable the AD probe under **Administration > System > Deployment > Profiling Configuration**. When this probe is enabled, Cisco ISE fetches the AD attributes for a new endpoint as soon as it receives a hostname. The hostname is typically learned from the DHCP or DNS probes. Once successfully retrieved, ISE does not attempt to query AD again for the same endpoint until a the rescan timer expires. This is to limit the load on AD for attribute queries. The rescan timer is configurable in the **Days Before Rescan** field (**Administration > System > Deployment > Profiling Configuration > Active Directory**). If there is additional profiling activity on the endpoint, the AD is queried again.

The following AD probe attributes can be matched in the **Policy > Policy Elements > Profiling** using the **ACTIVEDIRECTORY** condition. AD attributes collected using the AD Probe appear with the prefix “AD” in the endpoint details on the **Context Visibility > Endpoints** window.

- AD-Host-Exists
- AD-Join-Point
- AD-Operating-System
- AD-OS-Version
- AD-Service-Pack

## Configure Probes for Each Cisco ISE Node

You can configure one or more probes on the Profiling Configuration tab per Cisco ISE node in your deployment that assumes the Policy Service persona, which could be:

- A standalone node: If you have deployed Cisco ISE on a single node that assumes all Administration, Monitoring, and Policy Service personas by default.


- **Multiple nodes:** If you have registered more than one node in your deployment that assume Policy Service persona.



**Note** Not all probes are enabled by default. Some probes are partially enabled even when they are not explicitly enabled by a check mark. The profiling configuration is currently unique to each PSN. We recommend that each PSN in the deployment should be configured with identical profiler configuration settings.

### Before you begin

You can configure the probes per Cisco ISE node only from the Administration node, which is unavailable on the secondary Administration node in a distributed deployment.

- 
- Step 1** Choose In the Cisco ISE GUI, click the **Menu** icon () and choose **Administration > System > Deployment**.
  - Step 2** Choose a Cisco ISE node that assumes the Policy Service persona.
  - Step 3** Click **Edit** in the Deployment Nodes page.
  - Step 4** On the **General Settings** tab, check the **Policy Service** check box. If the Policy Service check box is unchecked, both the session services and the profiling service check boxes are disabled.
  - Step 5** Check the **Enable Profiling Services** check box.
  - Step 6** Click the **Profiling Configuration** tab.
  - Step 7** Configure the values for each probe.
  - Step 8** Click **Save** to save the probe configuration.
- 

## Setup CoA, SNMP RO Community, and Endpoint Attribute Filter

Cisco ISE allows a global configuration to issue a Change of Authorization (CoA) in the Profiler Configuration page that enables the profiling service with more control over endpoints that are already authenticated.

In addition, you can configure additional SNMP Read Only community strings separated by a comma for the NMAP manual network scan in the Profiler Configuration page. The SNMP RO community strings are used in the same order as they appear in the Current custom SNMP community strings field.

You can also configure endpoint attribute filtering in the Profiler Configuration page.

- 
- Step 1** Choose **Administration > System > Settings > Profiling**.
  - Step 2** Choose one of the following settings to configure the CoA type:
    - **No CoA** (default)—You can use this option to disable the global configuration of CoA. This setting overrides any configured CoA per endpoint profiling policy. If the goal is only visibility, retain the default value as **No CoA**.
    - **Port Bounce**—You can use this option, if the switch port exists with only one session. If the port exists with multiple sessions, then use the Reauth option. If the goal is to immediately update the access policy based on profile changes, select the **Port Bounce** option, this will ensure that any clientless endpoints is reauthorized, and IP address is refreshed, if required.

- **Reauth**—You can use this option to enforce reauthentication of an already authenticated endpoint when it is profiled. Select the **Reauth** option, if no VLAN or address change is expected following the reauthorization of the current session.

**Note** If you have multiple active sessions on a single port, the profiling service issues a CoA with the **Reauth** option even though you have configured CoA with the **Port Bounce** option. This function avoids disconnecting other sessions, a situation that might occur with the **Port Bounce** option.

**Step 3** Enter new SNMP community strings separated by a comma for the NMAP manual network scan in the **Change Custom SNMP Community Strings** field, and re-enter the strings in the **Confirm Custom SNMP Community Strings** field for confirmation.

The default SNMP community string used is *public*. Click **Show** in the **Current Custom SNMP Community Strings** section to verify this.

**Step 4** Check the **Endpoint Attribute Filter** check box to enable endpoint attribute filtering.

On enabling the **Endpoint Attribute Filter**, the Cisco ISE profiler only keeps significant attributes and discards all other attributes. For more information, see [Global Setting to Filter Endpoint Attributes, on page 651](#) and [Attribute Filters for ISE Database Persistence and Performance, on page 650](#) sections. As a best practice, we recommend you to enable **Endpoint Attribute Filter** in production deployments.

**Step 5** Click **Save**.

## Global Configuration of Change of Authorization for Authenticated Endpoints

You can use the global configuration feature to disable change of authorization (CoA) by using the default No CoA option or enable CoA by using port bounce and reauthentication options. If you have configured Port Bounce for CoA in Cisco ISE, the profiling service may still issue other CoAs as described in the “CoA Exemptions” section.

The global configuration chosen dictates the default CoA behavior only in the absence of more specific settings. See [Change of Authorization Configuration for Each Endpoint Profiling Policy, on page 674](#).

You can use the RADIUS probe or the Monitoring persona REST API to authenticate the endpoints. You can enable the RADIUS probe, which allows faster performance. If you have enabled CoA, then we recommend that you enable the RADIUS probe in conjunction with your CoA configuration in the Cisco ISE application for faster performance. The profiling service can then issue an appropriate CoA for endpoints by using the RADIUS attributes that are collected.

If you have disabled the RADIUS probe in the Cisco ISE application, then you can rely on the Monitoring persona REST API to issue CoAs. This allows the profiling service to support a wider range of endpoints. In a distributed deployment, your network must have at least one Cisco ISE node that assumes the Monitoring persona to rely on the Monitoring persona REST API to issue a CoA.

Cisco ISE arbitrarily will designate either the primary or secondary Monitoring node as the default destination for REST queries in your distributed deployment, because both the primary and secondary Monitoring nodes have identical session directory information.

## Use Cases for Issuing Change of Authorization

The profiling service issues the change of authorization in the following cases:

- Endpoint deleted: When an endpoint is deleted from the Endpoints page and the endpoint is disconnected or removed from the network.
- An exception action is configured: If you have an exception action configured per profile that leads to an unusual or an unacceptable event from that endpoint. The profiling service moves the endpoint to the corresponding static profile by issuing a CoA.
- An endpoint is profiled for the first time: When an endpoint is not statically assigned and profiled for the first time; for example, the profile changes from an unknown to a known profile.
  - An endpoint identity group has changed: When an endpoint is added or removed from an endpoint identity group that is used by an authorization policy.

The profiling service issues a CoA when there is any change in an endpoint identity group, and the endpoint identity group is used in the authorization policy for the following:

- The endpoint identity group changes for endpoints when they are dynamically profiled
  - The endpoint identity group changes when the static assignment flag is set to true for a dynamic endpoint
- 
- An endpoint profiling policy has changed and the policy is used in an authorization policy: When an endpoint profiling policy changes, and the policy is included in a logical profile that is used in an authorization policy. The endpoint profiling policy may change due to the profiling policy match or when an endpoint is statically assigned to an endpoint profiling policy, which is associated to a logical profile. In both the cases, the profiling service issues a CoA, only when the endpoint profiling policy is used in an authorization policy.

## Exemptions for Issuing a Change of Authorization

The profiling service does not issue a CoA when there is a change in an endpoint identity group and the static assignment is already true.

Cisco ISE does not issue a CoA for the following reasons:

- An Endpoint disconnected from the network—When an endpoint disconnected from your network is discovered.
- Authenticated wired (Extensible Authentication Protocol) EAP-capable endpoint—When an authenticated wired EAP-capable endpoint is discovered.
- Multiple active sessions per port—When you have multiple active sessions on a single port, the profiling service issues a CoA with the Reauth option even though you have configured CoA with the Port Bounce option.
- Packet-of-Disconnect CoA (Terminate Session) when a wireless endpoint is detected—If an endpoint is discovered as wireless, then a Packet-of-Disconnect CoA (Terminate-Session) is issued instead of the Port Bounce CoA. The benefit of this change is to support the Wireless LAN Controller (WLC) CoA.
- Profiler CoA is suppressed when the **Suppress Profiler CoA for endpoints in Logical Profile** option is used for the configured logical profile in the Authorization Profile. Profiler CoA will be triggered for all other endpoints by default.

- Global No CoA Setting overrides Policy CoA—Global No CoA overrides all configuration settings in endpoint profiling policies as there is no CoA issued in Cisco ISE irrespective of CoA configured per endpoint profiling policy.



**Note** No CoA and Reauth CoA configurations are not affected, and the profiler service applies the same CoA configuration for wired and wireless endpoints.

## Change of Authorization Issued for Each Type of CoA Configuration

*Table 50: Change of Authorization Issued for Each Type of CoA Configuration*

| Scenarios                                                     | No CoA Configuration | Port Bounce Configuration                    | Reauth Configuration | Additional Information                                                                      |
|---------------------------------------------------------------|----------------------|----------------------------------------------|----------------------|---------------------------------------------------------------------------------------------|
| Global CoA configuration in Cisco ISE (typical configuration) | No CoA               | Port Bounce                                  | Reauthentication     | —                                                                                           |
| An endpoint is disconnected on your network                   | No CoA               | No CoA                                       | No CoA               | Change of authorization is determined by the RADIUS attribute Acct-Status -Type value Stop. |
| Wired with multiple active sessions on the same switch port   | No CoA               | Reauthentication                             | Reauthentication     | Reauthentication avoids disconnecting other sessions.                                       |
| Wireless endpoint                                             | No CoA               | Packet-of-Disconnect CoA (Terminate Session) | Reauthentication     | Support to Wireless LAN Controller.                                                         |
| Incomplete CoA data                                           | No CoA               | No CoA                                       | No CoA               | Due to missing RADIUS attributes.                                                           |

## Attribute Filters for ISE Database Persistence and Performance

Cisco ISE implements filters for Dynamic Host Configuration Protocol (both DHCP Helper and DHCP SPAN), HTTP, RADIUS, and Simple Network Management Protocol probes except for the NetFlow probe to address performance degradation. Each probe filter contains the list of attributes that are temporal and irrelevant for endpoint profiling and removes those attributes from the attributes collected by the probes.

The isebootstrap log (isebootstrap-yyyymmdd-xxxxxx.log) contains messages that handles the creation of dictionaries and with filtering of attributes from the dictionaries. You can also configure to log a debug message when endpoints go through the filtering phase to indicate that filtering has occurred.

The Cisco ISE profiler invokes the following endpoint attribute filters:

- A DHCP filter for both the DHCP Helper and DHCP SPAN contains all the attributes that are not necessary and they are removed after parsing DHCP packets. The attributes after filtering are merged with existing attributes in the endpoint cache for an endpoint.
- An HTTP filter is used for filtering attributes from HTTP packets, where there is no significant change in the set of attributes after filtering.
- A RADIUS filter is used once the syslog parsing is complete and endpoint attributes are merged into the endpoint cache for profiling.
- SNMP filter for SNMP Query includes separate CDP and LLDP filters, which are all used for SNMP-Query probe.

## Global Setting to Filter Endpoint Attributes

You can reduce the number of persistence events and replication events by reducing the number of endpoint attributes that do not change frequently at the collection point. Enabling the **EndPoint Attribute Filter** will have the Cisco ISE profiler only to keep significant attributes and discard all other attributes. Significant attributes are those used by the Cisco ISE system or those used specifically in an endpoint profiling policy or rule.

To enable the **EndPoint Attribute Filter**, see the [Setup CoA, SNMP RO Community, and Endpoint Attribute Filter, on page 647](#) section.

An allowed list is a set of attributes that are used in custom endpoint profiling policies for profiling endpoints, and that are essential for Change of Authorization (CoA), Bring Your Own Device (BYOD), Device Registration WebAuth (DRW), and so on to function in Cisco ISE as expected. The allowed list is always used as a criteria when ownership changes for the endpoint (when attributes are collected by multiple Policy Service nodes) even when disabled.

By default, the allowed list is disabled and the attributes are dropped only when the attribute filter is enabled. The allowed list is dynamically updated when endpoint profiling policies change including from the feed to include new attributes in the profiling policies. Any attribute that is not present in the allowed list is dropped immediately at the time of collection, and the attribute is not used for profiling endpoints. When combined with the buffering, the number of persistence events can be reduced.

You must ensure that the allowed list contains a set of attributes determined from the following two sources:

- A set of attributes that are used in the default profiles so that you can match endpoints to the profiles.
- A set of attributes that are essential for Change of Authorization (CoA), Bring Your Own Device (BYOD), Device Registration WebAuth (DRW), and so on to function as expected.



**Note** To add an new attribute to the allowed list, the administrator needs to create a new profiler condition and policy that uses the attribute. This new attribute will be automatically added to the allowed list of stored and replicated attributes.

**Table 51: Allowed Attributes**

|            |                  |
|------------|------------------|
| AAA-Server | BYODRegistration |
|------------|------------------|

|                           |                             |
|---------------------------|-----------------------------|
| Calling-Station-ID        | Certificate Expiration Date |
| Certificate Issue Date    | Certificate Issuer Name     |
| Certificate Serial Number | Description                 |
| DestinationIPAddress      | Device Identifier           |
| Device Name               | DeviceRegistrationStatus    |
| EndPointPolicy            | EndPointPolicyID            |
| EndPointProfilerServer    | EndPointSource              |
| FQDN                      | FirstCollection             |
| Framed-IP-Address         | IdentityGroup               |
| IdentityGroupID           | IdentityStoreGUID           |
| IdentityStoreName         | L4_DST_PORT                 |
| LastNmapScanTime          | MACAddress                  |
| MatchedPolicy             | MatchedPolicyID             |
| NADAddress                | NAS-IP-Address              |
| NAS-Port-Id               | NAS-Port-Type               |
| NmapScanCount             | NmapSubnetScanID            |
| OS Version                | OUI                         |
| PolicyVersion             | PortalUser                  |
| PostureApplicable         | Product                     |
| RegistrationTimeStamp     | —                           |
| StaticAssignment          | StaticGroupAssignment       |
| TimeToProfile             | Total Certainty Factor      |
| User-Agent                | cdpCacheAddress             |
| cdpCacheCapabilities      | cdpCacheDeviceId            |
| cdpCachePlatform          | cdpCacheVersion             |
| ciaddr                    | dhcp-class-identifier       |
| dhcp-requested-address    | host-name                   |
| hrDeviceDescr             | ifIndex                     |
| ip                        | lldpCacheCapabilities       |



|                              |                       |
|------------------------------|-----------------------|
| lldpCapabilitiesMapSupported | lldpSystemDescription |
| operating-system             | sysDescr              |
| 161-udp                      | —                     |

## Attributes Collection from Cisco IOS Sensor-Embedded Switches

An Cisco IOS sensor integration allows Cisco ISE run time and the Cisco ISE profiler to collect any or all of the attributes that are sent from the switch. You can collect DHCP, CDP, and LLDP attributes directly from the switch by using the RADIUS protocol. The attributes that are collected for DHCP, CDP, and LLDP are then parsed and mapped to attributes in the profiler dictionaries in the following location: **Policy > Policy Elements > Dictionaries**.

For information about the supported Catalyst platforms for Device sensors, see <https://communities.cisco.com/docs/DOC-72932>.

### Cisco IOS Sensor-Embedded Network Access Devices

Integrating Cisco IOS sensor embedded network access devices with Cisco ISE involves the following components:

- A Cisco IOS sensor
- Data collector that is embedded in the network access device (switch) for gathering DHCP, CDP, and LLDP data
- Analyzers for processing the data and determining the device-type of endpoints

There are two ways of deploying an analyzer, but they are not expected to be used in conjunction with each other:

- An analyzer can be deployed in Cisco ISE
- Analyzers can be embedded in the switch as the sensor

### Configuration Checklist for Cisco IOS Sensor-Enabled Network Access Devices

This section summarizes a list of tasks that you must configure in the Cisco IOS sensor-enabled switches and Cisco ISE to collect DHCP, CDP, and LLDP attributes directly from the switch:

- Ensure that the RADIUS probe is enabled in Cisco ISE.
- Ensure that network access devices support an IOS sensor for collecting DHCP, CDP, and LLDP information.
- Ensure that network access devices run the following CDP and LLDP commands to capture CDP and LLDP information from endpoints:

```
cdp enable
lldp run
```

- Ensure that session accounting is enabled separately by using the standard AAA and RADIUS commands.

For example, use the following commands:

```
aaa new-model
aaa accounting dot1x default start-stop group radius

radius-server host <ip> auth-port <port> acct-port <port> key <shared-secret>
radius-server vsa send accounting
```

- Ensure that you run IOS sensor-specific commands.

- Enabling Accounting Augmentation

You must enable the network access devices to add Cisco IOS sensor protocol data to the RADIUS accounting messages and to generate additional accounting events when it detects new sensor protocol data. This means that any RADIUS accounting message should include all CDP, LLDP, and DHCP attributes.

Enter the following global command:

```
device-sensor accounting
```

- Disabling Accounting Augmentation

To disable (accounting) network access devices and add Cisco IOS sensor protocol data to the RADIUS accounting messages for sessions that are hosted on a given port (if the accounting feature is globally enabled), enter the following command at the appropriate port:

```
no device-sensor accounting
```

- TLV Change Tracking

By default, for each supported peer protocol, client notifications and accounting events are generated only when an incoming packet includes a type, length, and value (TLV) that has not been received previously in the context of a given session.

You must enable client notifications and accounting events for all TLV changes where there are either new TLVs, or where previously received TLVs have different values. Enter the following command:

```
device-sensor notify all-changes
```

- Be sure that you disable the Cisco IOS Device Classifier (local analyzer) in the network access devices.

Enter the following command:

```
no macro auto monitor
```




---

**Note** This command prevents network access devices from sending two identical RADIUS accounting messages per change.

---

# Profiler Conditions

Profiling conditions are policy elements and are similar to other conditions. However unlike authentication, authorization, and guest conditions, the profiling conditions can be based on a limited number of attributes. The Profiler Conditions page lists the attributes that are available in Cisco ISE and their description.

Profiler conditions can be one of the following:

- **Cisco Provided:** Cisco ISE includes predefined profiling conditions when deployed and they are identified as Cisco Provided in the Profiler Conditions window. You cannot delete Cisco Provided profiling conditions.

You can also find Cisco Provided conditions in the System profiler dictionaries in the following location: **Policy > Policy Elements > Dictionaries > System.**

For example, MAC dictionary. For some products, the OUI (Organizationally Unique Identifier) is a unique attribute that you can use it first for identifying the manufacturing organization of devices. It is a component of the device MAC address. The MAC dictionary contains the MACAddress and OUI attributes.

- **Administrator Created:** Profiler conditions that you create as an administrator of Cisco ISE or predefined profiling conditions that are duplicated are identified as Administrator Created. You can create a profiler condition of DHCP, MAC, SNMP, IP, RADIUS, NetFlow, CDP, LLDP, and NMAP types using the profiler dictionaries in the **Profiler Conditions** window.

Although, the recommended upper limit for the number of profiling policies is 1000, you can stretch up to 2000 profiling policies.

# Profiling Network Scan Actions

An endpoint scan action is a configurable action that can be referred to in an endpoint profiling policy, and that is triggered when the conditions that are associated with the network scan action are met.

An endpoint scan is used to scan endpoints in order to limit resources usage in the Cisco ISE system. A network scan action scans a single endpoint, unlike resource-intensive network scans. It improves the overall classification of endpoints, and redefines an endpoint profile for an endpoint. Endpoint scans can be processed only one at a time.

You can associate a single network scan action to an endpoint profiling policy. Cisco ISE predefines three scanning types for a network scan action, which can include one or all three scanning types: for instance, an OS-scan, an SNMPPortsAndOS-scan, and a CommonPortsAndOS-scan. You cannot edit or delete OS-scan, SNMPPortsAndOS-scan, and CommonPortsAndOS-scans, which are predefined network scan actions in Cisco ISE. You can also create a new network scan action of your own.

Once an endpoint is appropriately profiled, the configured network scan action cannot be used against that endpoint. For example, scanning an Apple-Device allows you to classify the scanned endpoint to an Apple device. Once an OS-scan determines the operating system that an endpoint is running, it is no longer matched to an Apple-Device profile, but it is matched to an appropriate profile for an Apple device.

## Create a New Network Scan Action

A network scan action that is associated with an endpoint profiling policy scans an endpoint for an operating system, Simple Network Management Protocol (SNMP) ports, and common ports. Cisco provides network scan actions for the most common NMAP scans, but you can also create one of your own.

When you create a new network scan, you define the type of information that the NMAP probe will scan for.

### Before you begin

The Network Scan (NMAP) probe must be enabled before you can define a rule to trigger a network scan action. The procedure for that is described in [Configure Probes for Each Cisco ISE Node](#).

- 
- Step 1** Choose **Policy > Policy Elements > Results > Profiling > Network Scan (NMAP) Actions**. Alternatively, you can choose **Work Centers > Profiler > Policy Elements > NMAP Scan Actions**.
- Step 2** Click **Add**.
- Step 3** Enter a name and description for the network scan action that you want to create.
- Step 4** Check one or more check boxes when you want to scan an endpoint for the following:
- Scan OS: To scan for an operating system
  - Scan SNMP Port: To scan SNMP ports (161, 162)
  - Scan Common Port: To scan common ports.
  - Scan Custom Ports: To scan custom ports.
  - Scan Include Service Version Information: To scan the version information, which may contain detailed description of the device.
  - Run SMB Discovery Script: To scan SMB ports (445 and 139) to retrieve information such as the OS and computer name.
  - Skip NMAP Host Discovery: To skip the initial host discovery stage of the NMAP scan.
- Note** The Skip NMAP Host Discovery option is selected by default for automatic NMAP scan, however, you must select it to run manual NMAP scan.
- Step 5** Click **Submit**.
- 

## NMAP Operating System Scan

The operating system scan (OS-scan) type scans for an operating system (and OS version) that an endpoint is running. This is a resource intensive scan.

The NMAP tool has limitations on OS-scan which may cause unreliable results. For example, when scanning an operating system of network devices such as switches and routers, the NMAP OS-scan may provide an incorrect operating-system attribute for those devices. Cisco ISE displays the operating-system attribute, even if the accuracy is not 100%.

You should configure endpoint profiling policies that use the NMAP operating-system attribute in their rules to have low certainty value conditions (Certainty Factor values). We recommend that whenever you create

an endpoint profiling policy based on the NMAP:operating-system attribute, include an AND condition to help filter out false results from NMAP.

The following NMAP command scans the operating system when you associate Scan OS with an endpoint profiling policy:

```
nmap -sS -O -F -oN /opt/CSCOcpm/logs/nmap.log --append-output -oX - <IP-address>
```

The following NMAP command scans a subnet and sends the output to nmapSubnet.log:

```
nmap -O -sU -p U:161,162 -oN /opt/CSCOcpm/logs/nmapSubnet.log
--append-output -oX - <subnet>
```

**Table 52: NMAP Commands for a Manual Subnet Scan**

|                  |                                                     |
|------------------|-----------------------------------------------------|
| -O               | Enables OS detection                                |
| -sU              | UDP scan                                            |
| -p <port ranges> | Scans only specified ports. For example, U:161, 162 |
| oN               | Normal output                                       |
| oX               | XML output                                          |

## Operating System Ports

The following table lists the TCP ports that NMAP uses for OS scanning. In addition, NMAP uses ICMP and UDP port 51824.

|     |     |     |     |     |     |     |     |     |
|-----|-----|-----|-----|-----|-----|-----|-----|-----|
| 1   | 3   | 4   | 6   | 7   | 9   | 13  | 17  | 19  |
| 20  | 21  | 22  | 23  | 24  | 25  | 26  | 30  | 32  |
| 33  | 37  | 42  | 43  | 49  | 53  | 70  | 79  | 80  |
| 81  | 82  | 83  | 84  | 85  | 88  | 89  | 90  | 99  |
| 100 | 106 | 109 | 110 | 111 | 113 | 119 | 125 | 135 |
| 139 | 143 | 144 | 146 | 161 | 163 | 179 | 199 | 211 |
| 212 | 222 | 254 | 255 | 256 | 259 | 264 | 280 | 301 |
| 306 | 311 | 340 | 366 | 389 | 406 | 407 | 416 | 417 |
| 425 | 427 | 443 | 444 | 445 | 458 | 464 | 465 | 481 |
| 497 | 500 | 512 | 513 | 514 | 515 | 524 | 541 | 543 |
| 544 | 545 | 548 | 554 | 555 | 563 | 587 | 593 | 616 |
| 617 | 625 | 631 | 636 | 646 | 648 | 666 | 667 | 668 |
| 683 | 687 | 691 | 700 | 705 | 711 | 714 | 720 | 722 |
| 726 | 749 | 765 | 777 | 783 | 787 | 800 | 801 | 808 |
| 843 | 873 | 880 | 888 | 898 | 900 | 901 | 902 | 903 |

|      |      |      |      |           |           |           |           |           |
|------|------|------|------|-----------|-----------|-----------|-----------|-----------|
| 911  | 912  | 981  | 987  | 990       | 992       | 993       | 995       | 999       |
| 1000 | 1001 | 1002 | 1007 | 1009      | 1010      | 1011      | 1021      | 1022      |
| 1023 | 1024 | 1025 | 1026 | 1027      | 1028      | 1029      | 1030      | 1031      |
| 1032 | 1033 | 1034 | 1035 | 1036      | 1037      | 1038      | 1039      | 1040-1100 |
| 1102 | 1104 | 1105 | 1106 | 1107      | 1108      | 1110      | 1111      | 1112      |
| 1113 | 1114 | 1117 | 1119 | 1121      | 1122      | 1123      | 1124      | 1126      |
| 1130 | 1131 | 1132 | 1137 | 1138      | 1141      | 1145      | 1147      | 1148      |
| 1149 | 1151 | 1152 | 1154 | 1163      | 1164      | 1165      | 1166      | 1169      |
| 1174 | 1175 | 1183 | 1185 | 1186      | 1187      | 1192      | 1198      | 1199      |
| 1201 | 1213 | 1216 | 1217 | 1218      | 1233      | 1234      | 1236      | 1244      |
| 1247 | 1248 | 1259 | 1271 | 1272      | 1277      | 1287      | 1296      | 1300      |
| 1301 | 1309 | 1310 | 1311 | 1322      | 1328      | 1334      | 1352      | 1417      |
| 1433 | 1434 | 1443 | 1455 | 1461      | 1494      | 1500      | 1501      | 1503      |
| 1521 | 1524 | 1533 | 1556 | 1580      | 1583      | 1594      | 1600      | 1641      |
| 1658 | 1666 | 1687 | 1688 | 1700      | 1717      | 1718      | 1719      | 1720      |
| 1721 | 1723 | 1755 | 1761 | 1782      | 1783      | 1801      | 1805      | 1812      |
| 1839 | 1840 | 1862 | 1863 | 1864      | 1875      | 1900      | 1914      | 1935      |
| 1947 | 1971 | 1972 | 1974 | 1984      | 1998-2010 | 2013      | 2020      | 2021      |
| 2022 | 2030 | 2033 | 2034 | 2035      | 2038      | 2040-2043 | 2045-2049 | 2065      |
| 2068 | 2099 | 2100 | 2103 | 2105-2107 | 2111      | 2119      | 2121      | 2126      |
| 2135 | 2144 | 2160 | 2161 | 2170      | 2179      | 2190      | 2191      | 2196      |
| 2200 | 2222 | 2251 | 2260 | 2288      | 2301      | 2323      | 2366      | 2381-2383 |
| 2393 | 2394 | 2399 | 2401 | 2492      | 2500      | 2522      | 2525      | 2557      |
| 2601 | 2602 | 2604 | 2605 | 2607      | 2608      | 2638      | 2701      | 2702      |
| 2710 | 2717 | 2718 | 2725 | 2800      | 2809      | 2811      | 2869      | 2875      |
| 2909 | 2910 | 2920 | 2967 | 2968      | 2998      | 3000      | 3001      | 3003      |
| 3005 | 3006 | 3007 | 3011 | 3013      | 3017      | 3030      | 3031      | 3052      |
| 3071 | 3077 | 3128 | 3168 | 3211      | 3221      | 3260      | 3261      | 3268      |
| 3269 | 3283 | 3300 | 3301 | 3306      | 3322      | 3323      | 3324      | 3325      |

|           |           |           |      |      |      |           |      |      |
|-----------|-----------|-----------|------|------|------|-----------|------|------|
| 3333      | 3351      | 3367      | 3369 | 3370 | 3371 | 3372      | 3389 | 3390 |
| 3404      | 3476      | 3493      | 3517 | 3527 | 3546 | 3551      | 3580 | 3659 |
| 3689      | 3690      | 3703      | 3737 | 3766 | 3784 | 3800      | 3801 | 3809 |
| 3814      | 3826      | 3827      | 3828 | 3851 | 3869 | 3871      | 3878 | 3880 |
| 3889      | 3905      | 3914      | 3918 | 3920 | 3945 | 3971      | 3986 | 3995 |
| 3998      | 4000-4006 | 4045      | 4111 | 4125 | 4126 | 4129      | 4224 | 4242 |
| 4279      | 4321      | 4343      | 4443 | 4444 | 4445 | 4446      | 4449 | 4550 |
| 4567      | 4662      | 4848      | 4899 | 4900 | 4998 | 5000-5004 | 5009 | 5030 |
| 5033      | 5050      | 5051      | 5054 | 5060 | 5061 | 5080      | 5087 | 5100 |
| 5101      | 5102      | 5120      | 5190 | 5200 | 5214 | 5221      | 5222 | 5225 |
| 5226      | 5269      | 5280      | 5298 | 5357 | 5405 | 5414      | 5431 | 5432 |
| 5440      | 5500      | 5510      | 5544 | 5550 | 5555 | 5560      | 5566 | 5631 |
| 5633      | 5666      | 5678      | 5679 | 5718 | 5730 | 5800      | 5801 | 5802 |
| 5810      | 5811      | 5815      | 5822 | 5825 | 5850 | 5859      | 5862 | 5877 |
| 5900-5907 | 5910      | 5911      | 5915 | 5922 | 5925 | 5950      | 5952 | 5959 |
| 5960-5963 | 5987-5989 | 5998-6007 | 6009 | 6025 | 6059 | 6100      | 6101 | 6106 |
| 6112      | 6123      | 6129      | 6156 | 6346 | 6389 | 6502      | 6510 | 6543 |
| 6547      | 6565-6567 | 6580      | 6646 | 6666 | 6667 | 6668      | 6669 | 6689 |
| 6692      | 6699      | 6779      | 6788 | 6789 | 6792 | 6839      | 6881 | 6901 |
| 6969      | 7000      | 7001      | 7002 | 7004 | 7007 | 7019      | 7025 | 7070 |
| 7100      | 7103      | 7106      | 7200 | 7201 | 7402 | 7435      | 7443 | 7496 |
| 7512      | 7625      | 7627      | 7676 | 7741 | 7777 | 7778      | 7800 | 7911 |
| 7920      | 7921      | 7937      | 7938 | 7999 | 8000 | 8001      | 8002 | 8007 |
| 8008      | 8009      | 8010      | 8011 | 8021 | 8022 | 8031      | 8042 | 8045 |
| 8080-8090 | 8093      | 8099      | 8100 | 8180 | 8181 | 8192      | 8193 | 8194 |
| 8200      | 8222      | 8254      | 8290 | 8291 | 8292 | 8300      | 8333 | 8383 |
| 8400      | 8402      | 8443      | 8500 | 8600 | 8649 | 8651      | 8652 | 8654 |
| 8701      | 8800      | 8873      | 8888 | 8899 | 8994 | 9000      | 9001 | 9002 |
| 9003      | 9009      | 9010      | 9011 | 9040 | 9050 | 9071      | 9080 | 9081 |

|       |       |       |       |       |       |       |       |       |
|-------|-------|-------|-------|-------|-------|-------|-------|-------|
| 9090  | 9091  | 9099  | 9100  | 9101  | 9102  | 9103  | 9110  | 9111  |
| 9200  | 9207  | 9220  | 9290  | 9415  | 9418  | 9485  | 9500  | 9502  |
| 9503  | 9535  | 9575  | 9593  | 9594  | 9595  | 9618  | 9666  | 9876  |
| 9877  | 9878  | 9898  | 9900  | 9917  | 9929  | 9943  | 9944  | 9968  |
| 9998  | 9999  | 10000 | 10001 | 10002 | 10003 | 10004 | 10009 | 10010 |
| 10012 | 10024 | 10025 | 10082 | 10180 | 10215 | 10243 | 10566 | 10616 |
| 10617 | 10621 | 10626 | 10628 | 10629 | 10778 | 11110 | 11111 | 11967 |
| 12000 | 12174 | 12265 | 12345 | 13456 | 13722 | 13782 | 13783 | 14000 |
| 14238 | 14441 | 14442 | 15000 | 15002 | 15003 | 15004 | 15660 | 15742 |
| 16000 | 16001 | 16012 | 16016 | 16018 | 16080 | 16113 | 16992 | 16993 |
| 17877 | 17988 | 18040 | 18101 | 18988 | 19101 | 19283 | 19315 | 19350 |
| 19780 | 19801 | 19842 | 20000 | 20005 | 20031 | 20221 | 20222 | 20828 |
| 21571 | 22939 | 23502 | 24444 | 24800 | 25734 | 25735 | 26214 | 27000 |
| 27352 | 27353 | 27355 | 27356 | 27715 | 28201 | 30000 | 30718 | 30951 |
| 31038 | 31337 | 32768 | 32769 | 32770 | 32771 | 32772 | 32773 | 32774 |
| 32775 | 32776 | 32777 | 32778 | 32779 | 32780 | 32781 | 32782 | 32783 |
| 32784 | 32785 | 33354 | 33899 | 34571 | 34572 | 34573 | 34601 | 35500 |
| 36869 | 38292 | 40193 | 40911 | 41511 | 42510 | 44176 | 44442 | 44443 |
| 44501 | 45100 | 48080 | 49152 | 49153 | 49154 | 49155 | 49156 | 49157 |
| 49158 | 49159 | 49160 | 49161 | 49163 | 49165 | 49167 | 49175 | 49176 |
| 49400 | 49999 | 50000 | 50001 | 50002 | 50003 | 50006 | 50300 | 50389 |
| 50500 | 50636 | 50800 | 51103 | 51493 | 52673 | 52822 | 52848 | 52869 |
| 54045 | 54328 | 55055 | 55056 | 55555 | 55600 | 56737 | 56738 | 57294 |
| 57797 | 58080 | 60020 | 60443 | 61532 | 61900 | 62078 | 63331 | 64623 |
| 64680 | 65000 | 65129 | 65389 |       |       |       |       |       |

## NMAP SNMP Port Scan

The SNMPPortsAndOS-scan type scans an operating system (and OS version) that an endpoint is running and triggers an SNMP Query when SNMP ports (161 and 162) are open. It can be used for endpoints that are identified and matched initially with an Unknown profile for better classification.



The following NMAP command scans SNMP ports (UDP 161 and 162) when you associate the Scan SNMP Port with an endpoint profiling policy:

```
nmap -sU -p U:161,162 -oN /opt/CSCOcpm/logs/nmap.log --append-output -oX - <IP-address>
```

**Table 53: NMAP Commands for an Endpoint SNMP Port Scan**

|                  |                                                                      |
|------------------|----------------------------------------------------------------------|
| -sU              | UDP scan.                                                            |
| -p <port-ranges> | Scans only specified ports. For example, scans UDP ports 161 and 162 |
| oN               | Normal output.                                                       |
| oX               | XML output.                                                          |
| IP-address       | IP-address of an endpoint that is scanned.                           |

## NMAP Common Ports Scan

The CommonPortsAndOS-scan type scans an operating system (and OS version) that an endpoint is running and common ports (TCP and UDP), but not SNMP ports. The following NMAP command scans common ports when you associate Scan Common Port with an endpoint profiling policy:  
 nmap -sTU -p T:21,22,23,25,53,80,110,135,139,143,443,445,3306,3389,8080,U:53,67,68,123,135,137,138,139,161,445,500,520,631,1434,1900 -oN /opt/CSCOcpm/logs/nmap.log --append-output -oX - <IP address>

**Table 54: NMAP Commands for an Endpoint Common Ports Scan**

|                  |                                                                                                                                                       |
|------------------|-------------------------------------------------------------------------------------------------------------------------------------------------------|
| -sTU             | Both TCP connect scan and UDP scan.                                                                                                                   |
| -p <port ranges> | Scans TCP ports: 21,22,23,25,53,80,110,135,139,143, 443,445,3306,3389,8080 and UDP ports: 53,67,68,123,135,137, 138,139,161,445,500,520,631,1434,1900 |
| oN               | Normal output.                                                                                                                                        |
| oX               | XML output.                                                                                                                                           |
| IP address       | IP address of an endpoint that is scanned.                                                                                                            |

## Common Ports

The following table lists the common ports that NMAP uses for scanning.

**Table 55: Common Ports**

| TCP Ports |         | UDP Ports |         |
|-----------|---------|-----------|---------|
| Ports     | Service | Ports     | Service |
| 21/tcp    | ftp     | 53/udp    | domain  |
| 22/tcp    | ssh     | 67/udp    | dhcps   |
| 23/tcp    | telnet  | 68/udp    | dhcpc   |
| 25/tcp    | smtp    | 123/udp   | ntp     |

| TCP Ports |              | UDP Ports |              |
|-----------|--------------|-----------|--------------|
| Ports     | Service      | Ports     | Service      |
| 53/tcp    | domain       | 135/udp   | msrpc        |
| 80/tcp    | http         | 137/udp   | netbios-ns   |
| 110/tcp   | pop3         | 138/udp   | netbios-dgm  |
| 135/tcp   | msrpc        | 139/udp   | netbios-ssn  |
| 139/tcp   | netbios-ssn  | 161/udp   | snmp         |
| 143/tcp   | imap         | 445/udp   | microsoft-ds |
| 443/tcp   | https        | 500/udp   | isakmp       |
| 445/tcp   | microsoft-ds | 520/udp   | route        |
| 3389/tcp  | ms-term-serv | 1434/udp  | ms-sql-m     |
| 8080/tcp  | http-proxy   | 1900/udp  | upnp         |

## NMAP Custom Ports Scan

In addition to the common ports, you can use custom ports (**Work Centers > Profiler > Policy Elements > NMAP Scan Actions** or **Policy > Policy Elements > Results > Profiling > Network Scan (NMAP) Actions**) to specify automatic and manual NMAP scan actions. NMAP probes collect the attributes from endpoints via the specified custom ports that are open. These attributes are updated in the endpoint's attribute list in the ISE Identities page (**Work Centers > Network Access > Identities > Endpoints**). You can specify up to 10 UDP and 10 TCP ports for each scan action. You cannot use the same port numbers that you have specified as common ports. See [Configure Profiler Policies Using the McAfee ePolicy Orchestrator](#) for more information.

## NMAP Include Service Version Information Scan

The Include Service Version Information NMAP probe automatically scans the endpoints to better classify them, by collecting information about services running on the device. The service version option can be combined with common ports or custom ports.

Example:

CLI Command: `nmap -sV -p T:8083 172.21.75.217`

Output:

| Port     | State | Service | Version                                                                                                                     |
|----------|-------|---------|-----------------------------------------------------------------------------------------------------------------------------|
| 8083/tcp | open  | http    | McAfee ePolicy Orchestrator Agent 4.8.0.1500 (ePOServerName: WIN2008EPO, AgentGuid: {15D79A24-33BA-407E-7C8E-15790A2433BA}) |

## NMAP SMB Discovery Scan

NMAP SMB Discovery scan helps differentiate the Windows versions, and results in a better endpoint profiling. You can configure the NMAP scan action to run the SMB discovery script that is provided by NMAP.

The NMAP scan action is incorporated within the windows default policies and when the endpoint matches the policy and the scanning rule, the endpoint is scanned and the result helps to determine the exact windows version. The policy will be then configured on the feed service and new pre-defined NMAP scan is created with the SMB discovery option.

The NMAP scan action is invoked by the Microsoft-Workstation policies and the result of the scan is saved on the endpoint under the operating system attribute and leveraged to the Windows policies. You can also find the SMB Discovery script option in the manual scan on the subnet.



---

**Note** For SMB discovery, be sure to enable the Windows file sharing option in the endpoint.

---

### SMB Discovery Attributes

When the SMB discovery script is executed on the endpoint, new SMB discovery attributes, such as SMB.Operating-system, are added to the endpoint. These attributes are considered for updating the Windows endpoint profiling policies on the feed service. When a SMB discovery script is run, the SMB discovery attribute is prefixed with SMB, such as SMB.operating-system, SMB.lanmanager, SMB.server, SMB.fqdn, SMB.domain, SMB.workgroup, and SMB.cpe.

### Skip NMAP Host Discovery

Scanning every port of every single IP address is a time-consuming process. Depending on the purpose of the scan, you can skip the NMAP host discovery of active endpoints.

If a NMAP scan is triggered after the classification of an endpoint, the profiler always skips the host discovery of the endpoint. However, if a manual scan action is triggered after enabling the Skip NMAP Host Discovery Scan, then host discovery is skipped.

### NMAP Scan Workflow

Steps to be followed to perform a NMAP scan:

#### Before you begin

In order to run NMAP SMB discovery script, you must enable the file sharing in your system. Refer to the [Enable File Sharing to Run NMAP SMB Discovery Script](#) topic for an example.

- 
- Step 1** [Create an SMB Scan Action.](#)
  - Step 2** [Configure the Profiler Policy Using the SMB Scan Action.](#)
  - Step 3** [Add a New Condition Using the SMB Attribute.](#)
-

## Create an SMB Scan Action

- Step 1**
- Step 2** Enter the **Action Name** and **Description**.
- Step 3** Check the **Run SMB Discovery Script** checkbox.
- Step 4** Click **Add** to create the network access users.

The screenshot shows the Cisco Identity Services Engine (ISE) GUI. The breadcrumb navigation is: Policy > Profiling > Results > Network Scan (NMAP) Actions. The main configuration area is titled "Network Scan (NMAP) Action". It contains the following fields and options:

- Action Name:** SMBScanAction
- Description:** SMBScanAction
- System Type:** Administrator Created
- Scan Options:**
  - OS
  - SNMP Port
  - Common Port <sup>i</sup>
  - Custom ports <sup>i</sup>
  - Include service version information <sup>i</sup>
  - Run SAMBA Discovery script
  - Skip NMAP Host Discovery <sup>i</sup>

At the bottom of the form are "Save" and "Reset" buttons.


### What to do next

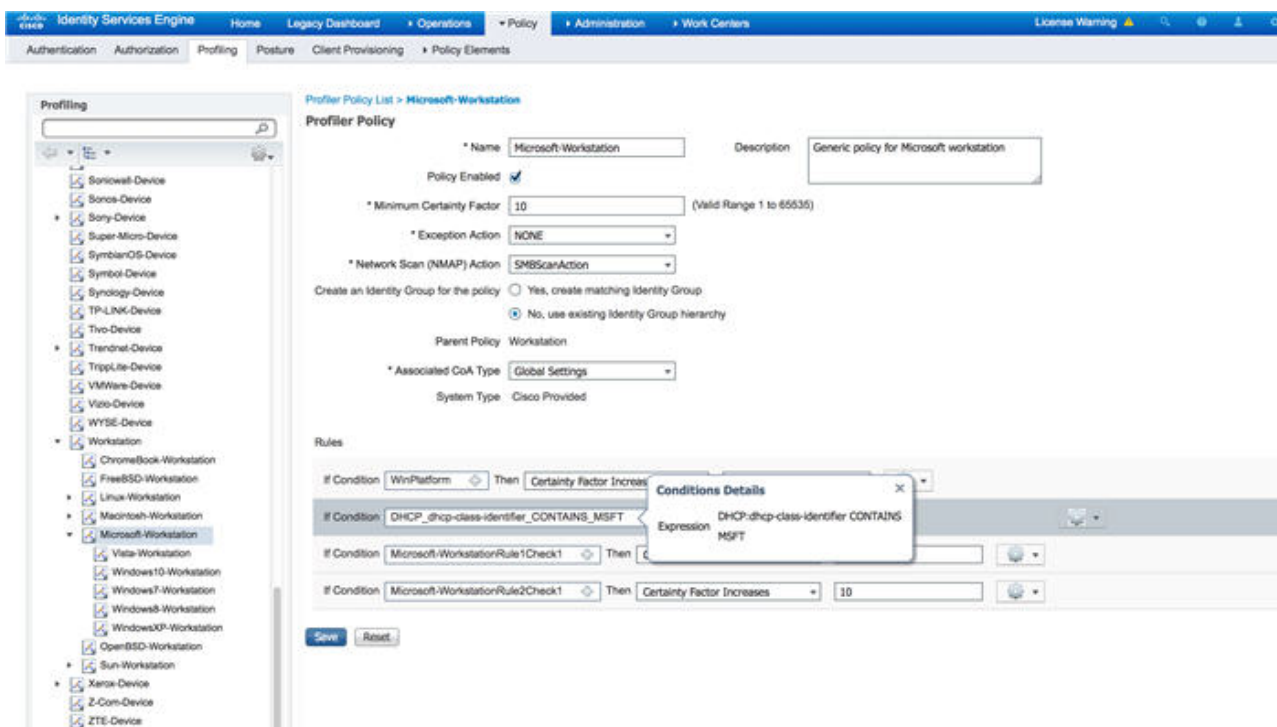
You should configure the profiler policy using the SMB scan action.

## Configure the Profiler Policy Using the SMB Scan Action

### Before you begin

You must create a new profiler policy to scan an endpoint with the SMB scan action. For example, you can scan a Microsoft Workstation by specifying a rule that if the DHCP class identifier contains the MSFT attribute, then a network action should be taken.

- Step 1** ChooseIn the Cisco ISE GUI, click the **Menu** icon () and choose **Policy > Profiling > Add**.
- Step 2** Enter the **Name** and **Description**.
- Step 3** In the drop-down, select the scan action (for example, SMBScanAction) that you had created.  
**Network Scan (NMAP) Action**



**What to do next**

You should add a new condition using the SMB attribute.

**Add a New Condition Using the SMB Attribute**

**Before you begin**

You should create a new profiler policy to scan the version of an endpoint. For example, you can scan for Windows 7 under the Microsoft Workstation parent policy.

- Step 1** Choose In the Cisco ISE GUI, click the **Menu** icon (☰) and choose **Policy > Profiling > Add**.
- Step 2** Enter the **Name** (for example, Windows-7Workstation) and **Description**.
- Step 3** In the **Network Scan (NMAP) Action** drop-down, select **None**.
- Step 4** In the **Parent Policy** drop-down choose the Microsoft-Workstation policy.

## Enable File Sharing to Run NMAP SMB Discovery Script

Profiler Policy List > **Windows7-Workstation**

**Profiler Policy**

\* Name:  Description:

Policy Enabled:

\* Minimum Certainty Factor:  (Valid Range 1 to 65535)

\* Exception Action:

\* Network Scan (NMAP) Action:

Create an Identity Group for the policy:  Yes, create matching Identity Group  
 No, use existing Identity Group hierarchy

\* Parent Policy:

\* Associated CoA Type:

System Type: Cisco Provided

**Rules**

If Condition:  Then:

If Condition:  Then:

If Condition:  Then:

If Condition:  Then:

## Enable File Sharing to Run NMAP SMB Discovery Script

Given below is an example to enable file sharing in Windows OS version 7, to run the NMAP SMB discovery script.

- Step 1** Choose **Control Panel > Network and Internet**.
- Step 2** Click **Network and Sharing Center**.
- Step 3** Click **Change Advanced Sharing Settings**.
- Step 4** Click **Turn on File and Printer Sharing**.
- Step 5** Enable the following options: **Enable File Sharing for Devices That Use 40- or 56-bit Encryption** and **Turn on Password Protected Sharing**.
- Step 6** Click **Save Changes**.
- Step 7** Configure the Firewall settings.
- In the Control Panel, navigate to **System and Security > Windows Firewall > Allow a Program Through Windows Firewall**.
  - Check the **File and Printer Sharing** check box.
  - Click **OK**.
- Step 8** Configure the shared folder.
- Right-click the destination folder, and select **Properties**.
  - Click the **Sharing** tab, and click **Share**.
  - In the **File Sharing** dialog box, add the required names and click **Share**.
  - Click **Done** after the selected folder is shared.

- e) Click **Advanced Sharing** and select the **Share This Folder** check box.
- f) Click **Permissions**.
- g) In the **Permissions for Scans** dialog box, choose **Everyone** and check the **Full Control** check box.
- h) Click **OK**.

## Exclude Subnets from NMAP Scan

You can perform an NMAP scan to identify an endpoint's OS or SNMP port.

When performing the NMAP scan, you can exclude a whole subnet or IP range that should not be scanned by NMAP. You can configure the subnet or IP range in the **NMAP Scan Subnet Exclusions** window (**Work Centers > Profiler > Settings > NMAP Scan Subnet Exclusions**). This helps limit the load on your network and saves a considerable amount of time.

For Manual NMAP scan, you can use the **Run Manual NMAP Scan** window (**Work Centers > Profiler > Manual Scans > Manual NMAP Scan > Configure NMAP Scan Subnet Exclusions At**) to specify the subnet or IP range.

## Manual NMAP Scan Settings

You can perform a manual NMAP scan (**Work Centers > Profiler > Manual Scans > Manual NMAP Scan**) using the scan options that are available for automatic NMAP scan. You can choose either the scan options or the predefined ones.

*Table 56: Manual NMAP Scan Settings*

| Field Name                                      | Usage Guidelines                                                                                                                                                                                                                                 |
|-------------------------------------------------|--------------------------------------------------------------------------------------------------------------------------------------------------------------------------------------------------------------------------------------------------|
| <b>Node</b>                                     | Choose the ISE node from which the NMAP scan is run.                                                                                                                                                                                             |
| <b>Manual Scan Subnet</b>                       | Enter the range of subnet IP addresses of endpoints for which you want to run the NMAP scan.                                                                                                                                                     |
| <b>Configure NMAP Scan Subnet Exclusions At</b> | You will be directed to the <b>Work Centers &gt; Profiler &gt; Settings &gt; NMAP Scan Subnet Exclusions</b> window. Specify the IP address and subnet mask that should be excluded. If there is a match, the NMAP scan is not run.              |
| <b>NMAP Scan Subnet</b>                         | You can do one of the following: <ul style="list-style-type: none"> <li>• Specify Scan Options</li> <li>• Select an Existing NMAP Scan</li> </ul>                                                                                                |
| <b>Specify Scan Options</b>                     | Select the required scan options: OS, SNMP Port, Common Ports, Custom Ports, Include Service Version Information, Run SMB Discovery Script, Skip NMAP Host Discovery. See <a href="#">Create a New Network Scan Action</a> for more information. |

| Field Name                    | Usage Guidelines                                                                                                    |
|-------------------------------|---------------------------------------------------------------------------------------------------------------------|
| Select an Existing NMAP Scan  | Displays the <b>Existing NMAP Scan Actions</b> drop-down list that displays the default profiler NMAP scan actions. |
| Reset to Default Scan Options | Click this option to restore default settings (all scan options are checked).                                       |
| Save as NMAP Scan Action      | Enter an action name and a description.                                                                             |

## Run a Manual NMAP Scan

### Step 1

**Step 2** In the **Node** drop-down list, select the ISE node from which you intend to run the NMAP scan.

**Step 3** In the **Manual Scan Subnet** text box, enter the subnet address whose endpoints you intend to check for open ports.

**Step 4** Select one of the following:

- a) Choose **Specify Scan Options**, and on the right side of the page, choose the required scan options. Refer to the [Create a New Network Scan Action](#) page for more information.
- b) Choose **Select An Existing NMAP Scan Action** to select the default NMAP scan action, such as MCAFeeEPOOrchestratorClientScan.

**Step 5** Click **Run Scan**.

## Configure Profiler Policies Using the McAfee ePolicy Orchestrator

Cisco ISE profiling services can detect if the McAfee ePolicy Orchestrator (McAfee ePO) client is present on the endpoint. This helps in determining if a given endpoint belongs to your organization.

The entities involved in the process are:

- ISE Server
- McAfee ePO Server
- McAfee ePO Agent

Cisco ISE provides an in-built NMAP scan action (MCAFeeEPOOrchestratorClientscan) to check if the McAfee agent is running on an endpoint using NMAP McAfee script on the configured port. You can also create new NMAP scan options using the custom ports (for example, 8082). You can configure a new NMAP scan action using the McAfee ePO software by following the steps below:

**Step 1** [Configure the McAfee ePo NMAP Scan Action.](#)

**Step 2** [Configure the McAfee ePO Agent.](#)

**Step 3** [Configure Profiler Policies Using the McAfee ePO NMAP Scan Action.](#)



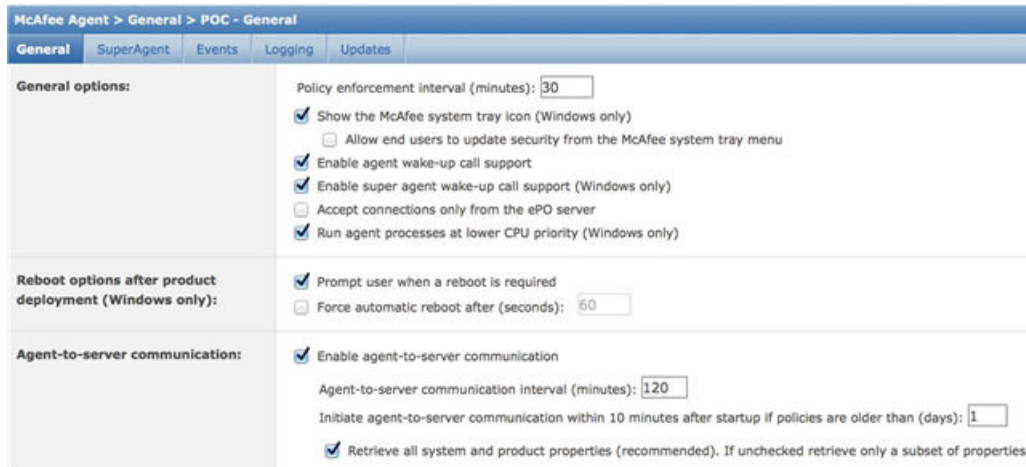
### Configure the McAfee ePo NMAP Scan Action

- Step 1** Choose **Work Centers > Profiler > Policy Elements > Network Scan (NMAP) Actions**.
- Step 2** Click **Add**.
- Step 3** Enter the **Action Name** and **Description**.
- Step 4** In the **Scan Options**, select **Custom Ports**.
- Step 5** In the **Custom Ports** dialog box, add the required TCP port. The 8080 TCP port is enabled by default for McAfee ePO.
- Step 6** Check the **Include Service Version Information** checkbox.
- Step 7** Click **Submit**.

### Configure the McAfee ePO Agent

- Step 1** In your McAfee ePO server, check the recommended settings to facilitate the communication between the McAfee ePO agent and the ISE server.

*Figure 55: McAfee ePO Agent Recommended Options*



- Step 2** Verify that the **Accept Connections Only From The ePO Server** is unchecked.

### Configure Profiler Policies Using the McAfee ePO NMAP Scan Action

- Step 1** Choose **Policy > Profiling > Add**.
- Step 2** Enter the **Name** and **Description**.
- Step 3** In the **Network Scan (NMAP) Action** drop-down list, select the required action (for example, MCAFeeEPOOrchestratorClientscan).
- Step 4** Create the parent profiler policy (for example, Microsoft-Workstation containing a rule to check if the DHCP class identifier contains the MSFT attribute).

Profiler Policy List > Microsoft-Workstation

Profiler Policy

\* Name  Description

Policy Enabled

\* Minimum Certainty Factor  (Valid Range 1 to 65535)

\* Exception Action

\* Network Scan (NMAP) Action

Create an Identity Group for the policy  Yes, create matching Identity Group  
 No, use existing Identity Group hierarchy

Parent Policy Workstation

\* Associated CoA Type

System Type Cisco Provided

Rules

If Condition  Then

If Condition  Then

If Condition  Then

If Condition  Then

**Conditions Details**

Expression DHCP:dhcp-class-identifier CONTAINS MSFT

**Step 5** Create a new policy (for example CorporateDevice) within the parent NMAP McAfee ePO policy (for example, Microsoft-Workstation) to check if the McAfee ePO agent is installed on the endpoint.

Endpoints that meet the condition are profiled as corporate devices. You can use the policy to move endpoints profiled with McAfee ePO agent to a new VLAN.

Profiler Policy List > New Profiler Policy

**Profiler Policy**

\* Name: CorporateDevice Description: [ ]

Policy Enabled:

\* Minimum Certainty Factor: 10 (Valid Range 1 to 65535)

\* Exception Action: NONE

\* Network Scan (NMAP) Action: NONE

Create an Identity Group for the policy:  Yes, create matching Identity Group  
 No, use existing Identity Group hierarchy

\* Parent Policy: Microsoft-Workstation

\* Associated CoA Type: Global Settings

System Type: [ ]

---

Rules

If Condition: NMAPEXension\_8081-tcp\_CONTAINS\_Mc...

**Conditions Details**

Expression: NMAPEXension:8081-tcp CONTAINS McAfee ePolicy Orchestrator Agent

Submit Cancel

## Profiler Endpoint Custom Attributes

Choose **Administration > Identity Management > Settings > Endpoint Custom Attributes** to assign attributes to endpoints, besides the attributes that the endpoint gathers from the probe. The endpoint custom attributes can be used in authorization policies to profile endpoints.

You can create a maximum of 100 endpoint custom attributes. The types of endpoint custom attributes supported are: Int, String, Long, Boolean, and Float.

You can add values for the endpoint custom attributes in the **Context Directory > Endpoints > Endpoint Classification** window.

Use cases for endpoint custom attributes include, to allow or block devices based on certain attributes or to assign certain privileges based on the authorization.

### Using Endpoint Custom Attributes in Authorization Policy

The endpoint custom attributes section allows you to configure extra attributes. Each definition consists of the attribute and type (String, Int, Boolean, Float, Long). You can profile devices using endpoint custom attributes.



**Note** You must have a plus or higher license to add custom attributes to the endpoints.

The following steps show how to create an authorization policy using endpoint custom attributes.

**Step 1** Create the endpoint custom attributes and assign values.

- a) Choose **Administration > Identity Management > Settings > Endpoint Custom Attributes** page.
- b) In the **Endpoint Custom Attributes** area, enter the **Attribute Name** (for example, deviceType), Data Type (for example, String) and Parameters.
- c) Click **Save**.

- d) Choose **Context Visibility > Endpoints > Summary**.
- e) Assign the custom attribute values.
  - Check the required MAC address check box, and click **Edit**.
  - Or, click the required MAC address, and on the Endpoints page, click **Edit**.
- f) In the **Edit Endpoint** dialog box, in the **Custom Attribute** area enter the required attribute values (for example, deviceType = Apple-iPhone).
- g) Click **Save**.

**Step 2** Create an authorization policy using the custom attributes and values.

- a) Navigate to the authorization policy page.
  - Choose **Work Centers > Profiler > Authorization Policy**.
  - Or, choose **Policy > Authorization**.
- b) Create the authorization policy by selecting the custom attributes from the Endpoints dictionary (for example, Rule Name: Corporate Devices, Conditions:EndPoints:deviceType Contains Apple-iPhone, Permissions: then PermitAccess).
- c) Click **Save**.

---

#### Related Topics

[Profiler Endpoint Custom Attributes](#), on page 671

## Create a Profiler Condition

Endpoint profiling policies in Cisco ISE allow you to categorize discovered endpoints on your network, and assign them to specific endpoint identity groups. These endpoint profiling policies are made up of profiling conditions that Cisco ISE evaluates to categorize and group endpoints.

#### Before you begin

To perform the following task, you must be a Super Admin or Policy Admin.

- Step 1** Choose **Policy > Policy Elements > Conditions > Profiling > Add**.
- Step 2** Enter values for the fields as described in the [Endpoint Profiling Policies Settings, on page 1087](#).
- Step 3** Click **Submit** to save the profiler condition.
- Step 4** Repeat this procedure to create more conditions.

---

#### Related Topics

[Profiler Conditions](#), on page 550

## Endpoint Profiling Policy Rules

You can define a rule that allows you to choose one or more profiling conditions from the library that are previously created and saved in the policy elements library, and to associate an integer value for the certainty

factor for each condition, or associate either an exception action or a network scan action for that condition. The exception action or the network scan action is used to trigger the configurable action while Cisco ISE is evaluating the profiling policies with respect to the overall classification of endpoints.

When the rules in a given policy are evaluated separately with an OR operator, the certainty metric for each rule contributes to the overall matching of the endpoint profiles into a specific category of endpoints. If the rules of an endpoint profiling policy match, then the profiling policy and the matched policy are the same for that endpoint when they are dynamically discovered on your network.

### Logically Grouped Conditions in Rules

An endpoint profiling policy (profile) contains a single condition or a combination of multiple single conditions that are logically combined using an AND or OR operator, against which you can check, categorize, and group endpoints for a given rule in a policy.

A condition is used to check the collected endpoint attribute value against the value specified in the condition for an endpoint. If you map more than one attribute, you can logically group the conditions, which helps you to categorize endpoints on your network. You can check endpoints against one or more such conditions with a corresponding certainty metric (an integer value that you define) associated with it in a rule or trigger an exception action that is associated to the condition or a network scan action that is associated to the condition.

### Certainty Factor

The minimum certainty metric in the profiling policy evaluates the matching profile for an endpoint. Each rule in an endpoint profiling policy has a minimum certainty metric (an integer value) associated to the profiling conditions. The certainty metric is a measure that is added for all the valid rules in an endpoint profiling policy, which measures how each condition in an endpoint profiling policy contributes to improve the overall classification of endpoints.

The certainty metric for each rule contributes to the overall matching of the endpoint profiles into a specific category of endpoints. The certainty metric for all the valid rules are added together to form the matching certainty. It must exceed the minimum certainty factor that is defined in an endpoint profiling policy. By default, the minimum certainty factor for all new profiling policy rules and predefined profiling policies is 10.

## Create Endpoint Profiling Policies

You can create new profiling policies to profile endpoints by using the following options in the New Profiler Policy page:

- Policy Enabled
- Create an Identity Group for the policy to create a matching endpoint identity group or use the endpoint identity group hierarchy
- Parent Policy
- Associated CoA Type




---

**Note** When you choose to create an endpoint policy in the **Profiling Policies** window, do not use the Stop button on your web browsers. This action leads to the following: stops loading the **New Profiler Policy** window, loads other list pages and the menus within the list pages when you access them, and prevents you from performing operations on all the menus within the list pages except the Filter menus. You might need to log out of Cisco ISE, and then log in again to perform operations on all the menus within the list pages.

---

You can create a similar characteristic profiling policy by duplicating an endpoint profiling policy through which you can modify an existing profiling policy instead of creating a new profiling policy by redefining all conditions.

- 
- Step 1** Choose **Policy > Profiling > Profiling Policies**.
  - Step 2** Click **Add**.
  - Step 3** Enter a name and description for the new endpoint policy that you want to create. The **Policy Enabled** check box is checked by default to include the endpoint profiling policy for validation when you profile an endpoint.
  - Step 4** Enter a value for the minimum certainty factor within the valid range 1 to 65535.
  - Step 5** Click the arrow next to the **Exception Action** drop-down list to associate an exception action or click the arrow next to the **Network Scan (NMAP) Action** drop-down list to associate a network scan action.
  - Step 6** Choose one of the following options for **Create an Identity Group for the policy**:
    - **Yes, create matching Identity Group**
    - **No, use existing Identity Group hierarchy**
  - Step 7** Click the arrow next to the **Parent Policy** drop-down list to associate a parent policy to the new endpoint policy.
  - Step 8** Choose a CoA type to be associated in the **Associated CoA Type** drop-down list.
  - Step 9** Click in the rule to add conditions and associate an integer value for the certainty factor for each condition or associate either an exception action or a network scan action for that condition for the overall classification of an endpoint.
  - Step 10** Click **Submit** to add an endpoint policy or click the **Profiler Policy List** link from the New Profiler Policy page to return to the Profiling Policies page.
- 

## Change of Authorization Configuration for Each Endpoint Profiling Policy

In addition to the global configuration of change of authorization (CoA) types in Cisco ISE, you can also configure to issue a specific type of CoA associated for each endpoint profiling policy.

The global No CoA type configuration overrides each CoA type configured in an endpoint profiling policy. If the global CoA type is set other than the No CoA type, then each endpoint profiling policy is allowed to override the global CoA configuration.

When a CoA is triggered, each endpoint profiling policy can determine the actual CoA type, as follows:

- **General Setting**—This is the default setting for all the endpoint profiling policies that issues a CoA per global configuration.

- No CoA—This setting overrides any global configuration and disables CoA for the profile.
- Port Bounce—This setting overrides the global Port Bounce and Reauth configuration types, and issues port bounce CoA.
- Reauth—This setting overrides the global Port Bounce and Reauth configuration types, and issues reauthentication CoA.



**Note** If the profiler global CoA configuration is set to Port Bounce (or Reauth), ensure that you configure corresponding endpoint profiling policies with No CoA, the per-policy CoA option so that the BYOD flow does not break for your mobile devices.

See the summary of configuration below combined for all the CoA types and the actual CoA type issued in each case based on the global and endpoint profiling policy settings.

*Table 57: CoA Type Issued for Various Combination of Configuration*

| Global CoA Type | Default CoA Type set per Policy | No coA Type per Policy | Port Bounce Type per Policy | Reauth Type per Policy |
|-----------------|---------------------------------|------------------------|-----------------------------|------------------------|
| No CoA          | No CoA                          | No CoA                 | No CoA                      | No CoA                 |
| Port Bounce     | Port Bounce                     | No CoA                 | Port Bounce                 | Re-Auth                |
| Reauth          | Reauth                          | No CoA                 | Port Bounce                 | Re-Auth                |

## Import Endpoint Profiling Policies

You can import endpoint profiling policies from a file in XML by using the same format that you can create in the export function. If you import newly created profiling policies that have parent policies associated, then you must have defined parent policies before you define child policies.

The imported file contains the hierarchy of endpoint profiling policies that contain the parent policy first, then the profile that you imported next along with the rules and checks that are defined in the policy.

- 
- Step 1** Choose **Policy > Profiling > Profiling > Profiling Policies**.
  - Step 2** Click **Import**.
  - Step 3** Click **Browse** to locate the file that you previously exported and want to import.
  - Step 4** Click **Submit**.
  - Step 5** Click the **Profiler Policy List** link to return to the **Profiling Policies** window.
-

## Export Endpoint Profiling Policies

You can export endpoint profiling policies to other Cisco ISE deployments. Or, you can use the XML file as a template for creating your own policies to import. You can also download the file to your system in the default location, which can be used for importing later.

A dialog appears when you want to export endpoint profiling policies, which prompts you to open the profiler\_policies.xml with an appropriate application or save it. This is a file in XML format that you can open in a web browser, or in other appropriate applications.

---

**Step 1** Choose **Policy > Profiling > Profiling > Profiling Policies**.

**Step 2** Choose **Export**, and choose one of the following:

- **Export Selected:** You can export only the selected endpoint profiling policies in the **Profiling Policies** window.
- **Export Selected with Endpoints:** You can export the selected endpoint profiling policies, and the endpoints that are profiled with the selected endpoint profiling policies.
- **Export All:** By default, you can export all the profiling policies in the **Profiling Policies** window.

**Step 3** Click **OK** to export the endpoint profiling policies in the profiler\_policies.xml file.

---

## Predefined Endpoint Profiling Policies

Cisco ISE includes predefined default profiling policies when Cisco ISE is deployed, and their hierarchical construction allows you to categorize identified endpoints on your network, and assign them to a matching endpoint identity groups. Because endpoint profiling policies are hierarchical, you can find that the **Profiling Policies** window displays the list of generic (parent) policies for devices and child policies to which their parent policies are associated in the Profiling Policies listing window.

The **Profiling Policies** window displays endpoint profiling policies with their names, type, description and the status, if enabled or not for validation.

The endpoint profiling policy types are classified as follows:

- **Cisco Provided:** Endpoint profiling policies that are predefined in Cisco ISE are identified as the Cisco Provided type.
  - **Administrator Modified:** Endpoint profiling policies are identified as the Administrator Modified type when you modify predefined endpoint profiling policies. Cisco ISE overwrites changes that you have made in the predefined endpoint profiling policies during upgrade.
- **Administrator Created:** Endpoint profiling policies that you create or when you duplicate Cisco-provided endpoint profiling policies are identified as the Administrator Created type.

We recommend that you create a generic policy (a parent) for a set of endpoints from which its children can inherit the rules and conditions. If an endpoint has to be classified, then the endpoint profile has to first match the parent, and then its descendant (child) policies when you are profiling an endpoint.

For example, Cisco-Device is a generic endpoint profiling policy for all Cisco devices, and other policies for Cisco devices are children of Cisco-Device. If an endpoint has to be classified as a Cisco-IP-Phone 7960, then



the endpoint profile for this endpoint has to first match the parent Cisco-Device policy, its child Cisco-IP-Phone policy, and then the Cisco-IP-Phone 7960 profiling policy for better classification.



**Note** Cisco ISE will not overwrite the Administrator Modified policies nor their children policies even if they are still labeled as Cisco Provided. If an Administrator Modified policy is deleted, it reverts back to the previous Cisco Provided policy. Next time when Feed Update happens, all children policies are updated.

## Predefined Endpoint Profiling Policies Overwritten During Upgrade

You can edit existing endpoint profiling policies in the Profiling Policies page. You must also save all your configurations in a copy of the predefined endpoint profiles when you want to modify the predefined endpoint profiling policies.

During an upgrade, Cisco ISE overwrites any configuration that you have saved in the predefined endpoint profiles.

## Unable to Delete Endpoint Profiling Policies

You can delete selected or all the endpoint profiling policies in the **Profiling Policies** window. By default, you can delete all the endpoint profiling policies from the **Profiling Policies** window. When you select all the endpoint profiling policies and try to delete them in the **Profiling Policies** window, some of them may not be deleted, if the endpoint profiling policies are mapped to other endpoint profiling policies or mapped to an authorization policy.

- You cannot delete Cisco Provided endpoint profiling policies.
- You cannot delete a parent profile in the **Profiling Policies** window when an endpoint profile is defined as a parent to other endpoint profiles. For example, Cisco-Device is a parent to other endpoint profiling policies for Cisco devices.
- You cannot delete an endpoint profile when it is mapped to an authorization policy. For example, Cisco-IP-Phone is mapped to the Profiled Cisco IP Phones authorization policy, and it is a parent to other endpoint profiling policies for Cisco IP Phones.

## Predefined Profiling Policies for Draeger Medical Devices

Cisco ISE contains default endpoint profiling policies that include a generic policy for Draeger medical devices, a policy for Draeger-Delta medical device, and a policy for Draeger-M300 medical device. Both the medical devices share ports 2050 and 2150, and therefore you cannot classify the Draeger-Delta and Draeger-M300 medical devices when you are using the default Draeger endpoint profiling policies.

If these Draeger devices share ports 2050 and 2150 in your environment, you must add a rule in addition to checking for the device destination IP address in the default Draeger-Delta and Draeger-M300 endpoint profiling policies so that you can distinguish these medical devices.

Cisco ISE includes the following profiling conditions that are used in the endpoint profiling policies for the Draeger medical devices:

- Draeger-Delta-PortCheck1 that contains port 2000

- Draeger-Delta-PortCheck2 that contains port 2050
- Draeger-Delta-PortCheck3 that contains port 2100
- Draeger-Delta-PortCheck4 that contains port 2150
- Draeger-M300PortCheck1 that contains port 1950
- Draeger-M300PortCheck2 that contains port 2050
- Draeger-M300PortCheck3 that contains port 2150

## Endpoint Profiling Policy for Unknown Endpoints

An endpoint that does not match existing profiles and cannot be profiled in Cisco ISE is an unknown endpoint. An unknown profile is the default system profiling policy that is assigned to an endpoint, where an attribute or a set of attributes collected for that endpoint do not match with existing profiles in Cisco ISE.

An Unknown profile is assigned in the following scenarios:

- When an endpoint is dynamically discovered in Cisco ISE, and there is no matching endpoint profiling policy for that endpoint, it is assigned to the unknown profile.
- When an endpoint is statically added in Cisco ISE, and there is no matching endpoint profiling policy for a statically added endpoint, it is assigned to the unknown profile.

If you have statically added an endpoint to your network, the statically added endpoint is not profiled by the profiling service in Cisco ISE. You can change the unknown profile later to an appropriate profile and Cisco ISE will not reassign the profiling policy that you have assigned.

## Endpoint Profiling Policy for Statically Added Endpoints

For the endpoint that is statically added to be profiled, the profiling service computes a profile for the endpoint by adding a new `MATCHEDPROFILE` attribute to the endpoint. The computed profile is the actual profile of an endpoint if that endpoint is dynamically profiled. This allows you to find the mismatch between the computed profile for statically added endpoints and the matching profile for dynamically profiled endpoints.

## Endpoint Profiling Policy for Static IP Devices

If you have an endpoint with a statically assigned IP address, you can create a profile for such static IP devices.

You must enable the RADIUS probe or SNMP Query and SNMP Trap probes to profile an endpoint that has a static IP address.

## Endpoint Profiling Policy Matching

Cisco ISE always considers a chosen policy for an endpoint that is the matched policy rather than an evaluated policy when the profiling conditions that are defined in one or more rules are met in a profiling policy. Here, the status of static assignment for that endpoint is set to false in the system. But, this can be set to true after it is statically reassigned to an existing profiling policy in the system, by using the static assignment feature during an endpoint editing.

The following apply to the matched policies of endpoints:

- For statically assigned endpoint, the profiling service computes the MATCHEDPROFILE.
- For dynamically assigned endpoints, the MATCHEDPROFILES are identical to the matching endpoint profiles.

You can determine a matching profiling policy for dynamic endpoints using one or more rules that are defined in a profiling policy and assign appropriately an endpoint identity group for categorization.

When an endpoint is mapped to an existing policy, the profiling service searches the hierarchy of profiling policies for the closest parent profile that has a matching group of policies and assigns the endpoint to the appropriate endpoint policy.

## Endpoint Profiling Policies Used for Authorization

You can use an endpoint profiling policy in authorization rules, where you can create a new condition to include a check for an endpoint profiling policy as an attribute, and the attribute value assumes the name of the endpoint profiling policy. You can select an endpoint profiling policy from the endpoints dictionary, which includes the following attributes: PostureApplicable, EndPointPolicy, LogicalProfile, and BYODRegistration.

The attribute value for PostureApplicable is auto set based on the operating system. It is set to *No* for IOS and Android devices because AnyConnect support is not available on those platforms to perform Posture. The value is set as *Yes* for Mac OSX and Windows devices.

You can define an authorization rule that includes a combination of EndPointPolicy, BYODRegistration, and identity groups.

## Endpoint Profiling Policies Grouped into Logical Profiles

A logical profile is a container for a category of profiles or associated profiles, irrespective of Cisco-provided or administrator-created endpoint profiling policies. An endpoint profiling policy can be associated to multiple logical profiles.

You can use the logical profile in an authorization policy condition to help create an overall network access policy for a category of profiles. You can create a simple condition for authorization, which can be included in the authorization rule. The attribute-value pair that you can use in the authorization condition is the logical profile (attribute) and the name of the logical profile (value), which can be found in the EndPoints systems dictionary.

For example, you can create a logical profile for all mobile devices like Android, Apple iPhone, or Blackberry by assigning matching endpoint profiling policies for that category to the logical profile. Cisco ISE contains IP-Phone, a default logical profile for all the IP phones, which includes IP-Phone, Cisco-IP-Phone, Nortel-IP-Phone-2000-Series, and Avaya-IP-Phone profiles.

## Create Logical Profiles

You can create a logical profile that you can use to group a category of endpoint profiling policies, which allows you to create an overall category of profiles or associated profiles. You can also remove the endpoint profiling policies from the assigned set moving them back to the available set. For more information about Logical Profiles, see [Endpoint Profiling Policies Grouped into Logical Profiles, on page 679](#).

- 
- Step 1** Choose **Policy > Profiling > Profiling > Logical Profiles**.
- Step 2** Click **Add**.
- Step 3** Enter a name and description for the new logical profile in the text boxes for **Name** and **Description**.
- Step 4** Choose endpoint profiling policies from the **Available Policies** to assign them in a logical profile.
- Step 5** Click the right arrow to move the selected endpoint profiling policies to the **Assigned Policies**.
- Step 6** Click **Submit**.
- 

## Profiling Exception Actions

An exception action is a single configurable action that can be referred to in an endpoint profiling policy, and that is triggered when the exception conditions that are associated with the action are met.

Exception Actions can be any one of the following types:

- **Cisco-provided**—You can not delete Cisco-provided exception actions. Cisco ISE triggers the following noneditable profiling exception actions from the system when you want to profile endpoints in Cisco ISE:
  - **Authorization Change**—The profiling service issues a change of authorization when an endpoint is added or removed from an endpoint identity group that is used by an authorization policy.
  - **Endpoint Delete**—An exception action is triggered in Cisco ISE and a CoA is issued when an endpoint is deleted from the system in the Endpoints page, or reassigned to the unknown profile from the edit page on a Cisco ISE network.
  - **FirstTimeProfiled**—An exception action is triggered in Cisco ISE and a CoA is issued when an endpoint is profiled in Cisco ISE for the first time, where the profile of that endpoint changes from an unknown profile to an existing profile but that endpoint is not successfully authenticated on a Cisco ISE network.
- **Administrator-created**—Cisco ISE triggers profiling exception actions that you create.

## Create Exception Actions

You can define and associate one or more exception rules to a single profiling policy. This association triggers an exception action (a single configurable action) when the profiling policy matches and at least one of the exception rules matches in the profiling endpoints in Cisco ISE.

- 
- Step 1** Choose **Policy > Policy Elements > Results > Profiling > Exception Actions**.
- Step 2** Click **Add**.
- Step 3** Enter a name and description for the exception action in the text boxes for **Name** and **Description**.
- Step 4** Check the **CoA Action** check box.
- Step 5** Click the **Policy Assignment** drop-down list to choose an endpoint policy.

**Step 6** Click **Submit**.

## Create Endpoints with Static Assignments of Policies and Identity Groups

You can create a new endpoint statically by using the MAC address of an endpoint in the Endpoints page. You can also choose an endpoint profiling policy and an identity group in the Endpoints page for static assignment.

The regular and mobile device (MDM) endpoints are displayed in the Endpoints Identities list. In the listing page, columns for attributes like Hostname, Device Type, Device Identifier for MDM endpoints are displayed. Other columns like Static Assignment and Static Group Assignment are not displayed by default.



**Note** You cannot add, edit, delete, import, or export MDM Endpoints using this page.

- Step 1** Choose **Work Centers > Network Access > Identities > Endpoints**.
- Step 2** Click **Add**.
- Step 3** Enter the MAC address of an endpoint in hexadecimal format and separated by a colon.
- Step 4** Choose a matching endpoint policy from the **Policy Assignment** drop-down list to change the static assignment status from dynamic to static.
- Step 5** Check the **Static Assignment** check box to change the status of static assignment that is assigned to the endpoint from dynamic to static.
- Step 6** Choose an endpoint identity group to which you want to assign the newly created endpoint from the **Identity Group Assignment** drop-down list.
- Step 7** Check the **Static Group Assignment** check box to change the dynamic assignment of an endpoint identity group to static.
- Step 8** Click **Submit**.

## Import Endpoints Using a CSV File

You can import endpoints from a CSV file that you have created from a Cisco ISE template and update it with endpoint details. Endpoints exported from Cisco ISE contains around 90 attributes and therefore cannot be imported directly into another ISE deployment. If columns that are not allowed for import are present in the CSV file, a message with the list of attributes that cannot be imported is displayed. You must delete the specified columns before trying to import the file again.

There are about 31 attributes that can be imported. The list includes MACAddress, EndPointPolicy, and IdentityGroup. Optional attributes are:

|                      |                      |              |
|----------------------|----------------------|--------------|
| Description          | PortalUser           | LastName     |
| PortalUser.GuestType | PortalUser.FirstName | EmailAddress |

|                                |                          |                  |
|--------------------------------|--------------------------|------------------|
| PortalUser.Location            | Device Type              | host-name        |
| PortalUser.GuestStatus         | StaticAssignment         | Location         |
| PortalUser.CreationType        | StaticGroupAssignment    | MDMEnrolled      |
| PortalUser.EmailAddress        | User-Name                | MDMOSVersion     |
| PortalUser.PhoneNumber         | DeviceRegistrationStatus | MDMServerName    |
| PortalUser.LastName            | AUPAccepted              | MDMServerID      |
| PortalUser.GuestSponsor        | FirstName                | BYODRegistration |
| CUSTOM.<custom attribute name> | —                        | —                |

The file header has to be in the format as specified in the default import template so that the list of endpoints appear in this order: MACAddress, EndpointPolicy, IdentityGroup <List of attributes listed above as optional attributes>. You can create the following file templates:

- MACAddress
- MACAddress, EndPointPolicy
- MACAddress, EndPointPolicy, IdentityGroup
- MACAddress, EndPointPolicy, IdentityGroup, <List of attributes listed above as optional attributes>

All attribute values, except MAC address, are optional for importing endpoints from a CSV file. If you want to import endpoints without certain values, the values are still separated by a comma. For example,

- MAC1, Endpoint Policy1, Endpoint Identity Group1
- MAC2
- MAC3, Endpoint Policy3
- MAC4, , Endpoint Identity Group4
- MAC5, , Endpoint Identity Group5, MyDescription, MyPortalUser, and so on

To import the endpoints using a CSV file:

- 
- Step 1** Choose **Context Visibility > Endpoints > Import** .
  - Step 2** Click **Import From File**.
  - Step 3** Click **Browse** to locate the CSV file that you have already created.
  - Step 4** Click **Submit**.
- 

To import endpoint custom attributes, you have to create the same custom attributes as in the CSV file in the **Administration > Identity Management > Settings > Endpoint Custom Attributes** window using the correct data types. These attributes have to be prefixed with CUSTOM to differentiate them from endpoint attributes.

## Default Import Template Available for Endpoints

You can generate a template in which you can update endpoints that can be used to import endpoints. By default, you can use the Generate a Template link to create a CSV file in the Microsoft Office Excel application and save the file locally on your system. The file can be found in **Context Visibility > Endpoints > Import > Import From File**. You can use the Generate a Template link to create a template, and the Cisco ISE server will display the Opening template.csv dialog. This dialog allows you to open the default template.csv file, or save the template.csv file locally on your system. If you choose to open the template.csv file from the dialog, the file opens in the Microsoft Office Excel application. The default template.csv file contains a header row that displays the MAC address, Endpoint Policy, and Endpoint Identity Group, and other optional attributes.

You must update the MAC addresses of endpoints, endpoint profiling policies, endpoint identity groups along with any of the optional attribute values you wish to import, and save the file with a new file name. This file can be used to import endpoints. See the header row in the template.csv file that is created when you use the Generate a Template link.

**Table 58: CSV Template File**

| MAC               | EndpointPolicy | IdentityGroup | Other Optional Attributes |
|-------------------|----------------|---------------|---------------------------|
| 11:11:11:11:11:11 | Android        | Profiled      | <Empty>/<Value>           |

## Unknown Endpoints Reprofiled During Import

If the file used for import contains endpoints that have their MAC addresses, and their assigned endpoint profiling policies is the Unknown profile, then those endpoints are immediately reprofiled in Cisco ISE to the matching endpoint profiling policies during import. However, they are not statically assigned to the Unknown profile. If endpoints do not have endpoint profiling policies assigned to them in the CSV file, then they are assigned to the Unknown profile, and then reprofiled to the matching endpoint profiling policies. See below how Cisco ISE reprofiles Unknown profiles that match the Xerox\_Device profile during import and also how Cisco ISE reprofiles an endpoint that is unassigned.

**Table 59: Unknown Profiles: Import from a File**

| MAC Address       | Endpoint Profiling Policy Assigned Before Import in Cisco ISE                                                                      | Endpoint Profiling Policy Assigned After Import in Cisco ISE |
|-------------------|------------------------------------------------------------------------------------------------------------------------------------|--------------------------------------------------------------|
| 00:00:00:00:01:02 | Unknown                                                                                                                            | Xerox-Device                                                 |
| 00:00:00:00:01:03 | Unknown                                                                                                                            | Xerox-Device                                                 |
| 00:00:00:00:01:04 | Unknown                                                                                                                            | Xerox-Device                                                 |
| 00:00:00:00:01:05 | If no profile is assigned to an endpoint, then it is assigned to the Unknown profile, and also reprofiled to the matching profile. | Xerox-Device                                                 |

## Endpoints with Invalid Attributes Not Imported

If any of the endpoints present in the CSV file have invalid attributes, then the endpoints are not imported and an error message is displayed.

For example, if endpoints are assigned to invalid profiles in the file used for import, then they are not imported because there are no matching profiles in Cisco ISE. See below how endpoints are not imported when they are assigned to invalid profiles in the CSV file.

**Table 60: Invalid Profiles: Import from a File**

| MAC Address       | Endpoint Profiling Policy Assigned Before Import in Cisco ISE                                                                                                                                                                                        | Endpoint Profiling Policy Assigned After Import in Cisco ISE                    |
|-------------------|------------------------------------------------------------------------------------------------------------------------------------------------------------------------------------------------------------------------------------------------------|---------------------------------------------------------------------------------|
| 00:00:00:00:01:02 | Unknown                                                                                                                                                                                                                                              | Xerox-Device                                                                    |
| 00:00:00:00:01:05 | If an endpoint such as 00:00:00:00:01:05 is assigned to an invalid profile other than the profiles that are available in Cisco ISE, then Cisco ISE displays a warning message that the policy name is invalid and the endpoint will not be imported. | The endpoint is not imported because there is no matching profile in Cisco ISE. |

## Import Endpoints from LDAP Server

You can import the MAC addresses, the associated profiles, and the endpoint identity groups of endpoints securely from an LDAP server.

### Before you begin

Before you begin to import endpoints, ensure that you have installed the LDAP server.

You have to configure the connection settings and query settings before you can import from an LDAP server. If the connection settings or query settings are configured incorrectly in Cisco ISE, then the “LDAP import failed:” error message appears.

- 
- Step 1** Choose **Context Visibility > Endpoints > Import > Import from LDAP**.
  - Step 2** Enter the values for the connection settings.
  - Step 3** Enter the values for the query settings.
  - Step 4** Click **Submit**.
- 

## Export Endpoints Using CSV File

You can export all the endpoints or only the selected endpoints using a CSV file. The endpoints are listed with around 90 attributes along with their MAC addresses, endpoint profiling policies, and endpoint identity groups. The custom attributes are also exported to the CSV file and are prefixed with CUSTOM to differentiate them from other endpoint attributes.





---

**Note** To import endpoint custom attributes that are exported from one deployment to another, you must create the same custom attributes in the **Administration > Identity Management > Settings > Endpoint Custom Attributes** window and use the same data type as specified in the original deployment.

---

**Export All** exports all the endpoints in Cisco ISE, whereas **Export Selected** exports only the endpoints selected by the user. By default, the profiler\_endpoints.csv is the CSV file and Microsoft Office Excel is the default application to open the CSV file.

To export the endpoints using a CSV file:

---

**Step 1** Choose **Context Visibility > Endpoints**.

**Step 2** From the **Export** drop-down list, choose one of the following options:

**Step 3** Click **OK** to save the CSV file.

Most of the attributes in the exported spreadsheet are simple. The following attributes require an explanation:

- *UpdateTime*: The last time that the profiler updated the endpoint, due to a change to an endpoint attribute. The value is 0 if there have been no updates since the endpoint session started. It will be blank briefly, during an update
- *InactivityTime*: Time since the endpoint was active.

---

## Identified Endpoints

Cisco ISE displays identified endpoints that connect to your network and use resources on your network in the **Endpoints** window. An endpoint is typically a network-capable device that connect to your network through wired and wireless network access devices and VPN. Endpoints can be personal computers, laptops, IP phones, smart phones, gaming consoles, printers, fax machines, and so on.

The MAC address of an endpoint, expressed in hexadecimal form, is always the unique representation of an endpoint, but you can also identify an endpoint with a varying set of attributes and the values associated to them, called an attribute-value pair. You can collect a varying set of attributes for endpoints based on the endpoint capability, the capability and configuration of the network access devices and the methods (probes) that you use to collect these attributes.

### Dynamically Profiled Endpoints

When endpoints are discovered on your network, they can be profiled dynamically based on the configured profiling endpoint profiling policies, and assigned to the matching endpoint identity groups depending on their profiles.

### Statically Profiled Endpoints

An endpoint can be profiled statically when you create an endpoint with its MAC address and associate a profile to it along with an endpoint identity group in Cisco ISE. Cisco ISE does not reassign the profiling policy and the identity group for statically assigned endpoints.

### Unknown Endpoints

If you do not have a matching profiling policy for an endpoint, you can assign an unknown profiling policy (Unknown) and the endpoint therefore will be profiled as Unknown. The endpoint profiled to the Unknown endpoint policy requires that you create a profile with an attribute or a set of attributes collected for that endpoint. The endpoint that does not match any profile is grouped within the Unknown endpoint identity group.

## Identified Endpoints Locally Stored in Policy Service Nodes Database

Cisco ISE writes identified endpoints locally in the Policy Service node database. After storing endpoints locally in the database, these endpoints are then made available (remote write) in the Administration node database only when significant attributes change in the endpoints, and replicated to the other Policy Service nodes database.

The following are the significant attributes:

- ip
- EndPointPolicy
- MatchedValue
- StaticAssignment
- StaticGroupAssignment
- MatchedPolicyID
- NmapSubnetScanID
- PortalUser
- DeviceRegistrationStatus
- BYODRegistration

When you change endpoint profile definitions in Cisco ISE, all endpoints have to be reprofiled. A Policy Service node that collects the attributes of endpoints is responsible for reprofiling of those endpoints.

When a Policy Service node starts collecting attributes about an endpoint for which attributes were initially collected by a different Policy Service node, then the endpoint ownership changes to the current Policy Service node. The new Policy Service node will retrieve the latest attributes from the previous Policy Service node and reconcile the collected attributes with those attributes that were already collected.

When a significant attribute changes in the endpoint, attributes of the endpoint are automatically saved in the Administration node database so that you have the latest significant change in the endpoint. If the Policy Service node that owns an endpoint is not available for some reasons, then the Administrator ISE node will reprofile an endpoint that lost the owner and you have to configure a new Policy Service node for such endpoints.

## Policy Service Nodes in Cluster

Cisco ISE uses Policy Service node group as a cluster that allows to exchange endpoint attributes when two or more nodes in the cluster collect attributes for the same endpoint. We recommend to create clusters for all Policy Service nodes that reside behind a load balancer.

If a different node other than the current owner receives attributes for the same endpoint, it sends a message across the cluster requesting the latest attributes from the current owner to merge attributes and determine if a change of ownership is needed. If you have not defined a node group in Cisco ISE, it is assumed that all nodes are within one cluster.

There are no changes made to endpoint creation and replication in Cisco ISE. Only the change of ownership for endpoints is decided based on an allowed list of attributes used for profiling that are built from static attributes and dynamic attributes.

Upon subsequent attributes collection, the endpoint is updated on the Administration node, if any one of the following attributes changes:

- ip
- EndPointPolicy
- MatchedValue
- StaticAssignment
- StaticGroupAssignment
- MatchedPolicyID
- NmapSubnetScanID
- PortalUser
- DeviceRegistrationStatus
- BYODRegistration

When an endpoint is edited and saved in the Administration node, the attributes are retrieved from the current owner of the endpoint.

## Create Endpoint Identity Groups

Cisco ISE groups endpoints that it discovers in to the corresponding endpoint identity groups. Cisco ISE comes with several system-defined endpoint identity groups. You can also create additional endpoint identity groups from the **Endpoint Identity Groups** window. You can edit or delete the endpoint identity groups that you have created. You can only edit the description of the system-defined endpoint identity groups. You cannot edit the name of these groups or delete them.

- 
- Step 1** Choose **Administration** > **Identity Management** > **Groups** > **Endpoint Identity Groups**.
  - Step 2** Click **Add**.
  - Step 3** Enter the **Name** for the endpoint identity group that you want to create (do not include spaces in the name of the endpoint identity group).
  - Step 4** Enter the **Description** for the endpoint identity group that you want to create.
  - Step 5** Click the **Parent Group** drop-down list to choose an endpoint identity group to which you want to associate the newly created endpoint identity group.
  - Step 6** Click **Submit**.
-

## Identified Endpoints Grouped in Endpoint Identity Groups

Cisco ISE groups discovered endpoints into their corresponding endpoint identity groups based on the endpoint profiling policies. Profiling policies are hierarchical, and they are applied at the endpoint identity groups level in Cisco ISE. By grouping endpoints to endpoint identity groups, and applying profiling policies to endpoint identity groups, Cisco ISE enables you to determine the mapping of endpoints to the endpoint profiles by checking corresponding endpoint profiling policies.

Cisco ISE creates a set of endpoint identity groups by default, and allows you to create your own identity groups to which endpoints can be assigned dynamically or statically. You can create an endpoint identity group and associate the identity group to one of the system-created identity groups. You can also assign an endpoint that you create statically to any one of the identity groups that exists in the system, and the profiling service cannot reassign the identity group.

## Default Endpoint Identity Groups Created for Endpoints

Cisco ISE creates the following endpoint identity groups:

- **blacklist:** This endpoint identity group includes endpoints that are statically assigned to this group in Cisco ISE and endpoints that are blocked in the device registration portal. An authorization profile can be defined in Cisco ISE to permit, or deny network access to endpoints in this group.
- **GuestEndpoints:** This endpoint identity group includes endpoints that are used by guest users.
- **Profiled:** This endpoint identity group includes endpoints that match endpoint profiling policies except Cisco IP phones and workstations in Cisco ISE.
- **RegisteredDevices:** This endpoint identity group includes endpoints, which are registered devices that are added by an employee through the devices registration portal. The profiling service continues to profile these devices normally when they are assigned to this group. Endpoints are statically assigned to this group in Cisco ISE, and the profiling service cannot reassign them to any other identity group. These devices will appear like any other endpoint in the endpoints list. You can edit, delete, and block these devices that you added through the device registration portal from the endpoints list in the Endpoints window in Cisco ISE. Devices that you have blocked in the device registration portal are assigned to the blacklist endpoint identity group, and an authorization profile that exists in Cisco ISE redirects blocked devices to a URL, which displays “Unauthorised Network Access”, a default portal page to the blocked devices.
- **Unknown:** This endpoint identity group includes endpoints that do not match any profile in Cisco ISE.

In addition to the above system created endpoint identity groups, Cisco ISE creates the following endpoint identity groups, which are associated to the Profiled (parent) identity group. A parent group is the default identity group that exists in the system:

- **Cisco-IP-Phone:** An identity group that contains all the profiled Cisco IP phones on your network.
- **Workstation:** An identity group that contains all the profiled workstations on your network.

## Endpoint Identity Groups Created for Matched Endpoint Profiling Policies

If you have an endpoint policy that matches an existing policy, then the profiling service can create a matching endpoint identity group. This identity group becomes the child of the Profiled endpoint identity group. When you create an endpoint policy, you can check the Create Matching Identity Group check box in the Profiling

Policies page to create a matching endpoint identity group. You cannot delete the matching identity group unless the mapping of the profile is removed.

## Add Static Endpoints in Endpoint Identity Groups

You can add or remove statically added endpoints in any endpoint identity group.

You can add endpoints from the Endpoints widget only to a specific identity group. If you add an endpoint to the specific endpoint identity group, then the endpoint is moved from the endpoint identity group where it was dynamically grouped earlier.

Upon removal from the endpoint identity group where you recently added an endpoint, the endpoint is reprofiled back to the appropriate identity group. You do not delete endpoints from the system but only remove them from the endpoint identity group.

- 
- Step 1** Choose **Administration** > **Identity Management** > **Groups** > **Endpoint Identity Groups**.
  - Step 2** Choose an endpoint identity group, and click **Edit**.
  - Step 3** Click **Add**.
  - Step 4** Choose an endpoint in the Endpoints widget to add the selected endpoint in the endpoint identity group.
  - Step 5** Click the **Endpoint Group List** link to return to the Endpoint Identity Groups page.
- 

## Dynamic Endpoints Reprofiled After Adding or Removing in Identity Groups

If an endpoint identity group assignment is not static, then endpoints are reprofiled after you add or remove them from an endpoint identity group. Endpoints that are identified dynamically by the ISE profiler appear in appropriate endpoint identity groups. If you remove dynamically added endpoints from an endpoint identity group, Cisco ISE displays a message that you have successfully removed endpoints from the identity group but reprofiles them back in the endpoint identity group.

## Endpoint Identity Groups Used in Authorization Rules

You can effectively use endpoint identity groups in the authorization policies to provide appropriate network access privileges to the discovered endpoints. For example, an authorization rule for all types of Cisco IP Phones is available by default in Cisco ISE in the following location: **Policy** > **Authorization** > **Standard**.

You must ensure that the endpoint profiling policies are either standalone policies (not a parent to other endpoint profiling policies), or their parent policies of the endpoint profiling policies are not disabled.

## Profiler Feed Service

Profiler conditions, exception actions, and NMAP scan actions are classified as Cisco-provided or administrator-created, as shown in the System Type attribute. Endpoint profiling policies are classified as Cisco-provided, administrator-created, or administrator-modified. These classifications are shown in the System Type attribute.

You can perform different operations on the profiler conditions, exception actions, NMAP scan actions, and endpoint profiling policies depending on the System Type attribute. You cannot edit or delete Cisco-provided conditions, exception actions, and nmap scan actions. You can not delete Endpoint policies that are provided by Cisco. When you edit policies, they are called administrator-modified. When the feed service updates policies, the administrator-modified policies are replaced by the up-to-date version of the Cisco-provided policy that it was based on.

You can retrieve new and updated endpoint profiling policies and the updated OUI database from the Cisco feed server. You must have a subscription to Cisco ISE. You can also receive e-mail notifications about applied, success, and failure messages. You can send the anonymous information back to Cisco about feed service actions, which helps Cisco improve the feed service.

The OUI database contains the MAC OUIs assigned to vendors. The OUI list is available here: <http://standards.ieee.org/develop/regauth/oui/oui.txt>

Cisco ISE downloads policies and OUI database updates every day at 1:00 A.M of the local Cisco ISE server time zone. Cisco ISE automatically applies these downloaded feed server policies, and stores the the changes so that you can revert to the previous state. When you revert to a previous state, the new endpoint profiling policies are removed and updated endpoint profiling policies are reverted to the previous state. In addition, the profiler feed service is automatically disabled.

You can also update the feed services manually in offline mode. You can download the updates manually by using this option if you cannot connect your ISE deployments to Cisco feed service.




---

**Note** Updates from the Feed Service are not allowed after the license goes Out of Compliance (OOC) for 45 days within a 60-day window period. The license is out of compliance when it has expired, or when the usage exceeds the allowed number of sessions.

---

## Configure Profiler Feed Service

The Profiler Feed Service retrieves new and updated endpoint profiling policies and MAC OUI database updates from the Cisco Feed server. If the Feed Service is unavailable or other errors have occurred, it is reported in the Operations Audit report.

You can configure Cisco ISE to send anonymous feed service usage report back to Cisco, which sends the following information to Cisco:

- Hostname: Cisco ISE hostname
- MaxCount: Total number of endpoints
- ProfiledCount: Profiled endpoints count
- UnknownCount: Unknown endpoints count
- MatchSystemProfilesCount: Cisco Provided profiles count
- UserCreatedProfiles: User created profiles count

You can change the CoA type in a Cisco-provided profiling policy. When the feed service updates that policy, the CoA type will not be changed, but the rest of that policy's attributes will be still be updated.

### Before you begin

The Profiler feed service can only be configured from the Cisco ISE Admin portal in a distributed deployment or in a standalone ISE node.

Set up a Simple Mail Transfer Protocol (SMTP) server if you plan to send e-mail notifications from the Admin portal about feed updates (**Administration > System > Settings**).

To update the Feed Services online:

- 
- Step 1** Choose **Administration > System > Certificates > Trusted Certificates**, and check if **QuoVadis Root CA 2** is enabled.
  - Step 2** Choose **Work Centers > Profiler > Feeds**.  
You can also access the option in the **Administration > FeedService > Profiler** page.
  - Step 3** Click the **Online Subscription Update** tab.
  - Step 4** Click the **Test Feed Service Connection** button to verify that there is a connection to the Cisco Feed Service, and that the certificate is valid.
  - Step 5** Check the **Enable Online Subscription Update** check box.
  - Step 6** Enter time in HH:MM format (local time zone of the Cisco ISE server). By default, Cisco ISE feed service is scheduled at 1.00 AM every day.
  - Step 7** Check the **Notify administrator when download occurs** check box and enter your e-mail address in the **Administrator email address** text box. Check the **Provide Cisco anonymous information to help improve profiling accuracy** check box, if you want to allow Cisco ISE to collect non-sensitive information (that will be used to provide better services and additional features in forthcoming releases).
  - Step 8** Click **Save**.
  - Step 9** Click **Update Now**.

Instructs Cisco ISE to contact Cisco feed server for new and updated profiles created since the last feed service update. This re-profiles all endpoints in the system, which may cause an increase the load on the system. Due to updated endpoint profiling policies, there may be changes in the authorization policy for some endpoints that are currently connected to Cisco ISE.

The **Update Now** button is disabled when you update new and updated profiles created since the last feed service and enabled only after the download is completed. You must navigate away from the profiler feed service configuration window and return to this window.

---

### Related Topics

[Configure Profiler Feed Services Offline](#), on page 691

## Configure Profiler Feed Services Offline

You can update the feed services offline when Cisco ISE is not directly connected to the Cisco feed server. You can download the offline update package from the Cisco feed server and upload it to Cisco ISE using the offline feed update. You can also set email notifications about new policies that are added to the feed server.

Configuring the profiler feed services offline involves the following tasks:

1. Download Offline Update Package
2. Apply Offline Feed Updates

## Download Offline Update Package

---

- Step 1** Choose **Work Centers > Profiler > Feeds**.  
You can also access the option in the **Administration > FeedService > Profiler** page.
- Step 2** Click the **Offline Manual Update** tab.
- Step 3** Click **Download Updated Profile Policies** link. You will be redirected to Feed Service Partner Portal.  
You can also go to <https://ise.cisco.com/partner/> from your browser, to go to the feed service partner portal directly.
- Step 4** If you are a first time user, accept the terms and agreements.  
An email will be triggered to Feed Services administrator to approve your request. Upon approval, you will receive a confirmation email.
- Step 5** Login to the partner portal using your Cisco.com credentials.
- Step 6** Choose **Offline Feed > Download Package** .
- Step 7** Click **Generate Package** .
- Step 8** Click the **Click to View the Offline Update Package contents** link to view all the profiles and OUIs that are included in the generated package.
- The policies under Feed Profiler 1 and Feed OUI will be downloaded to all versions of Cisco ISE.
  - The policies under Feed Profiler 2 will be downloaded only to Cisco ISE Release 1.3 and later.
  - The policies under Feed Profiler 3 will be downloaded only to Cisco ISE Release 2.1 and later.
- Step 9** Click **Download Package** and save the file to your local system.  
You can upload the saved file to Cisco ISE server to apply the feed updates in the downloaded package.
- 

## Apply Offline Feed Updates

### Before you begin

You must have downloaded the offline update package before applying the feed updates.

---

- Step 1** Choose **Work Centers > Profiler > Feeds** .  
You can also access the option in the **Administration > FeedService > Profiler** window.
- Step 2** Click the **Offline Manual Update** tab.
- Step 3** Click **Browse** and choose the downloaded profiler feed package.
- Step 4** Click **Apply Update** .
- 

## Configure Email Notifications for Profile and OUI Updates

You can configure your email address to receive notifications on profile and OUI updates.

---

- Step 1** Perform **Step 1** through **Step 5** in the [Download Offline Update Package](#) section to go to the Feed Service Partner Portal.
- Step 2** Choose **Offline Feed > Email Preferences**.



- Step 3** Check the **Enable Notifications** checkbox to receive notifications.
- Step 4** Choose the number of days from the **days** drop-down list to set the frequency in which you want to receive the notifications on new updates.
- Step 5** Enter the e-mail address/addresses and click **Save** .
- 

## Undo Feed Updates

You can revert endpoint profiling policies that were updated in the previous update and remove endpoint profiling policies and OUIs that are newly added through the previous update of the profiler feed service .

An endpoint profiling policy, if modified after an update from the feed server is not changed in the system.

---

- Step 1** Choose **Work Centers > Profiler > Feeds**.
- Step 2** Click **Go to Update Report Page** if you want to view the configuration changes made in the Change Configuration Audit report.
- Step 3** Click **Undo Latest**.
- 

## Profiler Reports

Cisco ISE provides you with various reports on endpoint profiling, and troubleshooting tools that you can use to manage your network. You can generate reports for historical as well as current data. You may be able to drill down on a part of the report to view more details. For large reports, you can also schedule reports and download them in various formats.

You can run the following reports for endpoints from **Operations > Reports > Endpoints and Users**:

- Endpoint Session History
- Profiled Endpoint Summary
- Endpoint Profile Changes
- Top Authorizations by Endpoint
- Registered Endpoints

## Detect Anomalous Behavior of Endpoints

Cisco ISE protects your network from the illegitimate use of a MAC address. Cisco ISE detects the endpoints involved in MAC address spoofing and allows you to restrict the permission of the suspicious endpoints.

The following are the two options in the profiler configuration page for Anomalous Behavior:

- Enable Anomalous Behavior Detection
- Enable Anomalous Behavior Enforcement

If you enable Anomalous Behavior detection, Cisco ISE probes for data, and checks for any contradiction to the existing data with respect to changes in attributes related to NAS-Port-Type, DHCP Class Identifier, and Endpoint Policy. If so, an attribute called **AnomalousBehavior** set to true is added to the endpoint which helps you to filter and view the endpoints in the Visibility Context page. Audit logs are also generated for the respective MAC address.

When anomalous behavior detection is enabled, Cisco ISE checks if the following attributes of existing endpoints have changed:

1. **Port-Type**—Determines if the access method of an endpoint has changed. This only applies when the same MAC address that is connected via Wired Dot1x has been used for Wireless Dot1x and visa-versa.
2. **DHCP Class Identifier**—Determines whether the type of client or vendor of an endpoint has changed. This only applies when DHCP Class identifier attribute is populated with a certain value and is then changed to another value. If an endpoint is configured with a static IP, the DHCP Class Identifier attribute is empty in Cisco ISE. Later on, if another device spoofs the MAC address of this endpoint and uses DHCP, the Class Identifier changes from an empty value to a specific string. This will not trigger anomalous behavior detection.
3. **Endpoint Policy**—Determines if there are significant profile changes. This only applies when the profile of an endpoint changes from a “Phone” or “Printer” to a “Workstation”.

If you enable Anomalous Behavior Enforcement, a CoA is issued upon detection of the anomalous Behavior, which can be used to re-authorize the suspicious endpoints, based on the authorization rules configured in the **Profiler Configuration** window.

## Set Authorization Policy Rules for Endpoints with Anomalous Behavior

You can choose the action to be taken against any endpoint with anomalous Behavior by setting the corresponding rules on the Authorization Policy page.

- 
- Step 1** Choose **Policy > Authorization**.
  - Step 2** Click the **Edit** drop-down arrow of any existing rule and click **Insert New Rule Above** or **Insert New Rule Below**.
  - Step 3** Enter the **Rule Name**.
  - Step 4** Click the add icon in the **Conditions** field and click **Create New Condition (Advance Option)**.
  - Step 5** Choose **Endpoints > AnomalousBehavior** from the **Select Attribute** drop-down.
  - Step 6** Enter “true” in the last field.
  - Step 7** Click the add icon in the **Permissions** column and choose the required actions from the **Select Item** drop-down list.

### Example:

You can choose **Standard > DenyAccess** from the Select Item drop-down list if you do not want to grant access to the attacker or suspicious end point.

- Step 8** Click **Done**.
- 

## View Endpoints with Anomalous Behavior

You can view the endpoints with anomalous behavior by using any of the following options:

- Click Anomalous Behavior from **Home > Summary > Metrics**. This action opens a new tab with Anomalous Behaviour column in the lower pane of the window.
- Choose **Context Visibility > Endpoints > Endpoint Classification**. You can view the Anomalous Behaviour column in the lower pane of the window.
- You can create a new Anomalous Behavior column in Authentication view or Compromised Endpoints view in the Context Visibility window as explained in the following steps:

- 
- Step 1** Choose **Context Visibility > Endpoints > Authentication** or **Context Visibility > Endpoints > Compromised Endpoints**.
- Step 2** Click the Settings icon in the lower pane of the window and check **Anomalous Behavior** check box..
- Step 3** Click **Go**.  
You can view the Anomalous Behavior column in the Authentication or Compromised Endpoints View.
- 

## Cisco ISE Integration with Cisco NAC Appliance

Cisco ISE supports integration only with the Cisco Network Admission Control (NAC) Appliance Release 4.9 and is available when you have installed an Advanced or Wireless license in Cisco ISE.

The Cisco ISE profiler is similar to the Cisco Network Admission Control (NAC) Profiler that manages endpoints in a Cisco NAC deployment. This integration allows you to replace the existing Cisco NAC Profiler that is installed in a Cisco NAC deployment. It allows you to synchronize profile names from the Cisco ISE profiler and the result of endpoint classification into the Cisco Clean Access Manager (CAM).

## Cisco Clean Access Manager Configuration in Administration Nodes

Cisco ISE allows you to register multiple Clean Access Managers (CAMs) on the Primary PAN in a distributed deployment for REST APIs communication settings. The list of CAMs that is registered in Cisco ISE is the list to which all the profiler configuration changes are notified. The Primary PAN is responsible for all the communication between Cisco ISE and the Cisco NAC Appliance. You can configure CAMs only in the Primary PAN in Cisco ISE. The credentials that are used at the time of registering one or more CAMs in the Primary PAN are used to authenticate connectivity with CAMs.

The communication between Cisco ISE and the Cisco NAC Appliance is secure over Secure Sockets Layer (SSL). It is also bidirectional in nature, because Cisco ISE pushes the profiler configuration changes to CAMs, and CAMs periodically pull the list of MAC addresses of endpoints and their corresponding profiles and the list of all the profile names, from Cisco ISE.

You must export the contents of the X509 Certificate from the Clean Access Manager in Administration > Clean Access Manager > SSL, and import it into the Primary PAN under Administration > System > Certificates > Trusted Certificates Store in Cisco ISE for a proper secure communication between Cisco ISE and CAM.

For more information on how to set up a pair of CAMs for high availability, see the link below.

## Cisco ISE Profiler and Cisco Clean Access Manager Communication

The Cisco ISE profiler notifies the profiler configuration changes to all the registered Clean Access Managers (CAMs) from the Primary PAN. It avoids duplicating notification in a Cisco ISE distributed deployment. It

uses the REST APIs to notify the profiler configuration changes when endpoints are added or removed, and endpoint profiling policies changed, in the Cisco ISE database. During an import of endpoints, the Cisco ISE profiler notifies CAMs only after the import is complete.

The following REST API flow is implemented to push the profiler configuration changes to CAMs:

Cisco ISE profiler endpoint change push—When endpoints are profiled and there are changes in the profiles of endpoints in Cisco ISE, then the Cisco ISE profiler notifies all the registered CAMs about the changes in the endpoint profiles.

You can configure Cisco ISE in CAMs, which allows you to synchronize CAMs with Cisco ISE, depending on your Sync Settings in CAMs. You must create rules, where you can select one or more matching profiles from the list of Cisco ISE profiles and map endpoints to any one of the Access Types in CAMs. CAMs periodically retrieve endpoints and their corresponding profiles and the list of all the profile names, from the Cisco ISE profiler.

The following REST API flows are implemented to pull the profiler configuration changes from the Cisco ISE profiler:

- NAC Manager endpoint pull—Pulls the list of MAC addresses of endpoints and their corresponding profiles of known endpoints.
- NAC Manager profile pull—Pulls the profile names from the Cisco ISE profiler.

The Cisco ISE profiler notifies the Cisco ISE Monitoring persona of all the events that can be used to monitor and troubleshoot Cisco ISE and Cisco NAC Appliance Release 4.9 integration.

The Cisco ISE profiler log captures the following events for monitoring and troubleshooting integration:

- Configuration changes for NAC Settings (Information)
- NAC notification event failure (Error)

## Add Cisco Clean Access Managers

Integrating Cisco ISE with the Cisco NAC Appliance, Release 4.9 allows you to utilize the Cisco ISE profiling service in a Cisco NAC deployment. to utilize the Cisco ISE profiling service in a Cisco NAC deployment.

The NAC Managers page allows you to configure multiple Cisco Access Managers (CAMs), which provides an option to filter the CAMs that you have registered. This page lists the CAMs along with their names, descriptions, IP addresses, and the status that displays whether endpoint notification is enabled or not for those CAMs.

- 
- Step 1** Choose **Administration > Network Resources > NAC Managers**.
  - Step 2** Click **Add**.
  - Step 3** Enter the name for the Cisco Access Manager.
  - Step 4** Click the **Status** check box to enable REST API communication from the Cisco ISE profiler that authenticates connectivity to the CAM.
  - Step 5** Enter the IP address for the CAM except the following IP addresses: 0.0.0.0 and 255.255.255.255.
  - Step 6** Enter the username and password of the CAM administrator that you use to log in to the user interface of the CAM.
  - Step 7** Click **Submit**.
-

# Create Endpoints with Static Assignments of Policies and Identity Groups

You can create a new endpoint statically by using the MAC address of an endpoint in the Endpoints page. You can also choose an endpoint profiling policy and an identity group in the Endpoints page for static assignment.

The regular and mobile device (MDM) endpoints are displayed in the Endpoints Identities list. In the listing page, columns for attributes like Hostname, Device Type, Device Identifier for MDM endpoints are displayed. Other columns like Static Assignment and Static Group Assignment are not displayed by default.



**Note** You cannot add, edit, delete, import, or export MDM Endpoints using this page.

- Step 1** Choose **Work Centers > Network Access > Identities > Endpoints**.
- Step 2** Click **Add**.
- Step 3** Enter the MAC address of an endpoint in hexadecimal format and separated by a colon.
- Step 4** Choose a matching endpoint policy from the **Policy Assignment** drop-down list to change the static assignment status from dynamic to static.
- Step 5** Check the **Static Assignment** check box to change the status of static assignment that is assigned to the endpoint from dynamic to static.
- Step 6** Choose an endpoint identity group to which you want to assign the newly created endpoint from the **Identity Group Assignment** drop-down list.
- Step 7** Check the **Static Group Assignment** check box to change the dynamic assignment of an endpoint identity group to static.
- Step 8** Click **Submit**.

## Import Endpoints Using a CSV File

You can import endpoints from a CSV file that you have created from a Cisco ISE template and update it with endpoint details. Endpoints exported from Cisco ISE contains around 90 attributes and therefore cannot be imported directly into another ISE deployment. If columns that are not allowed for import are present in the CSV file, a message with the list of attributes that cannot be imported is displayed. You must delete the specified columns before trying to import the file again.

There are about 31 attributes that can be imported. The list includes MACAddress, EndPointPolicy, and IdentityGroup. Optional attributes are:

|                        |                      |              |
|------------------------|----------------------|--------------|
| Description            | PortalUser           | LastName     |
| PortalUser.GuestType   | PortalUser.FirstName | EmailAddress |
| PortalUser.Location    | Device Type          | host-name    |
| PortalUser.GuestStatus | StaticAssignment     | Location     |

|                                |                          |                  |
|--------------------------------|--------------------------|------------------|
| PortalUser.CreationType        | StaticGroupAssignment    | MDMEnrolled      |
| PortalUser.EmailAddress        | User-Name                | MDMOSVersion     |
| PortalUser.PhoneNumber         | DeviceRegistrationStatus | MDMServerName    |
| PortalUser.LastName            | AUPAccepted              | MDMServerID      |
| PortalUser.GuestSponsor        | FirstName                | BYODRegistration |
| CUSTOM.<custom attribute name> | —                        | —                |

The file header has to be in the format as specified in the default import template so that the list of endpoints appear in this order: MACAddress, EndpointPolicy, IdentityGroup <List of attributes listed above as optional attributes>. You can create the following file templates:

- MACAddress
- MACAddress, EndPointPolicy
- MACAddress, EndPointPolicy, IdentityGroup
- MACAddress, EndPointPolicy, IdentityGroup, <List of attributes listed above as optional attributes>

All attribute values, except MAC address, are optional for importing endpoints from a CSV file. If you want to import endpoints without certain values, the values are still separated by a comma. For example,

- MAC1, Endpoint Policy1, Endpoint Identity Group1
- MAC2
- MAC3, Endpoint Policy3
- MAC4, , Endpoint Identity Group4
- MAC5, , Endpoint Identity Group5, MyDescription, MyPortalUser, and so on

To import the endpoints using a CSV file:

- 
- Step 1** Choose **Context Visibility** > **Endpoints** > **Import** .
  - Step 2** Click **Import From File**.
  - Step 3** Click **Browse** to locate the CSV file that you have already created.
  - Step 4** Click **Submit**.
- 

To import endpoint custom attributes, you have to create the same custom attributes as in the CSV file in the **Administration** > **Identity Management** > **Settings** > **Endpoint Custom Attributes** window using the correct data types. These attributes have to be prefixed with CUSTOM to differentiate them from endpoint attributes.

## Default Import Template Available for Endpoints

You can generate a template in which you can update endpoints that can be used to import endpoints. By default, you can use the Generate a Template link to create a CSV file in the Microsoft Office Excel application

and save the file locally on your system. The file can be found in **Context Visibility > Endpoints > Import > Import From File**. You can use the Generate a Template link to create a template, and the Cisco ISE server will display the Opening template.csv dialog. This dialog allows you to open the default template.csv file, or save the template.csv file locally on your system. If you choose to open the template.csv file from the dialog, the file opens in the Microsoft Office Excel application. The default template.csv file contains a header row that displays the MAC address, Endpoint Policy, and Endpoint Identity Group, and other optional attributes.

You must update the MAC addresses of endpoints, endpoint profiling policies, endpoint identity groups along with any of the optional attribute values you wish to import, and save the file with a new file name. This file can be used to import endpoints. See the header row in the template.csv file that is created when you use the Generate a Template link.

**Table 61: CSV Template File**

| MAC               | EndpointPolicy | IdentityGroup | Other Optional Attributes |
|-------------------|----------------|---------------|---------------------------|
| 11:11:11:11:11:11 | Android        | Profiled      | <Empty>/<Value>           |

## Unknown Endpoints Reprofiled During Import

If the file used for import contains endpoints that have their MAC addresses, and their assigned endpoint profiling policies is the Unknown profile, then those endpoints are immediately reprofiled in Cisco ISE to the matching endpoint profiling policies during import. However, they are not statically assigned to the Unknown profile. If endpoints do not have endpoint profiling policies assigned to them in the CSV file, then they are assigned to the Unknown profile, and then reprofiled to the matching endpoint profiling policies. See below how Cisco ISE reprofiles Unknown profiles that match the Xerox\_Device profile during import and also how Cisco ISE reprofiles an endpoint that is unassigned.

**Table 62: Unknown Profiles: Import from a File**

| MAC Address       | Endpoint Profiling Policy Assigned Before Import in Cisco ISE                                                                      | Endpoint Profiling Policy Assigned After Import in Cisco ISE |
|-------------------|------------------------------------------------------------------------------------------------------------------------------------|--------------------------------------------------------------|
| 00:00:00:00:01:02 | Unknown                                                                                                                            | Xerox-Device                                                 |
| 00:00:00:00:01:03 | Unknown                                                                                                                            | Xerox-Device                                                 |
| 00:00:00:00:01:04 | Unknown                                                                                                                            | Xerox-Device                                                 |
| 00:00:00:00:01:05 | If no profile is assigned to an endpoint, then it is assigned to the Unknown profile, and also reprofiled to the matching profile. | Xerox-Device                                                 |

## Endpoints with Invalid Attributes Not Imported

If any of the endpoints present in the CSV file have invalid attributes, then the endpoints are not imported and an error message is displayed.

For example, if endpoints are assigned to invalid profiles in the file used for import, then they are not imported because there are no matching profiles in Cisco ISE. See below how endpoints are not imported when they are assigned to invalid profiles in the CSV file.

Table 63: Invalid Profiles: Import from a File

| MAC Address       | Endpoint Profiling Policy Assigned Before Import in Cisco ISE                                                                                                                                                                                        | Endpoint Profiling Policy Assigned After Import in Cisco ISE                    |
|-------------------|------------------------------------------------------------------------------------------------------------------------------------------------------------------------------------------------------------------------------------------------------|---------------------------------------------------------------------------------|
| 00:00:00:00:01:02 | Unknown                                                                                                                                                                                                                                              | Xerox-Device                                                                    |
| 00:00:00:00:01:05 | If an endpoint such as 00:00:00:00:01:05 is assigned to an invalid profile other than the profiles that are available in Cisco ISE, then Cisco ISE displays a warning message that the policy name is invalid and the endpoint will not be imported. | The endpoint is not imported because there is no matching profile in Cisco ISE. |

## Import Endpoints from LDAP Server

You can import the MAC addresses, the associated profiles, and the endpoint identity groups of endpoints securely from an LDAP server.

### Before you begin

Before you begin to import endpoints, ensure that you have installed the LDAP server.

You have to configure the connection settings and query settings before you can import from an LDAP server. If the connection settings or query settings are configured incorrectly in Cisco ISE, then the “LDAP import failed:” error message appears.

- 
- Step 1** Choose **Context Visibility > Endpoints > Import > Import from LDAP**.
  - Step 2** Enter the values for the connection settings.
  - Step 3** Enter the values for the query settings.
  - Step 4** Click **Submit**.
- 

## Export Endpoints Using CSV File

You can export all the endpoints or only the selected endpoints using a CSV file. The endpoints are listed with around 90 attributes along with their MAC addresses, endpoint profiling policies, and endpoint identity groups. The custom attributes are also exported to the CSV file and are prefixed with CUSTOM to differentiate them from other endpoint attributes.




---

**Note** To import endpoint custom attributes that are exported from one deployment to another, you must create the same custom attributes in the **Administration > Identity Management > Settings > Endpoint Custom Attributes** window and use the same data type as specified in the original deployment.

---



**Export All** exports all the endpoints in Cisco ISE, whereas **Export Selected** exports only the endpoints selected by the user. By default, the `profiler_endpoints.csv` is the CSV file and Microsoft Office Excel is the default application to open the CSV file.

To export the endpoints using a CSV file:

---

**Step 1** Choose **Context Visibility > Endpoints**.

**Step 2** From the **Export** drop-down list, choose one of the following options:

**Step 3** Click **OK** to save the CSV file.

Most of the attributes in the exported spreadsheet are simple. The following attributes require an explanation:

- *UpdateTime*: The last time that the profiler updated the endpoint, due to a change to an endpoint attribute. The value is 0 if there have been no updates since the endpoint session started. It will be blank briefly, during an update
- *InactivityTime*: Time since the endpoint was active.

---

## Identified Endpoints

Cisco ISE displays identified endpoints that connect to your network and use resources on your network in the **Endpoints** window. An endpoint is typically a network-capable device that connect to your network through wired and wireless network access devices and VPN. Endpoints can be personal computers, laptops, IP phones, smart phones, gaming consoles, printers, fax machines, and so on.

The MAC address of an endpoint, expressed in hexadecimal form, is always the unique representation of an endpoint, but you can also identify an endpoint with a varying set of attributes and the values associated to them, called an attribute-value pair. You can collect a varying set of attributes for endpoints based on the endpoint capability, the capability and configuration of the network access devices and the methods (probes) that you use to collect these attributes.

### Dynamically Profiled Endpoints

When endpoints are discovered on your network, they can be profiled dynamically based on the configured profiling endpoint profiling policies, and assigned to the matching endpoint identity groups depending on their profiles.

### Statically Profiled Endpoints

An endpoint can be profiled statically when you create an endpoint with its MAC address and associate a profile to it along with an endpoint identity group in Cisco ISE. Cisco ISE does not reassign the profiling policy and the identity group for statically assigned endpoints.

### Unknown Endpoints

If you do not have a matching profiling policy for an endpoint, you can assign an unknown profiling policy (Unknown) and the endpoint therefore will be profiled as Unknown. The endpoint profiled to the Unknown endpoint policy requires that you create a profile with an attribute or a set of attributes collected for that endpoint. The endpoint that does not match any profile is grouped within the Unknown endpoint identity group.

## Identified Endpoints Locally Stored in Policy Service Nodes Database

Cisco ISE writes identified endpoints locally in the Policy Service node database. After storing endpoints locally in the database, these endpoints are then made available (remote write) in the Administration node database only when significant attributes change in the endpoints, and replicated to the other Policy Service nodes database.

The following are the significant attributes:

- ip
- EndPointPolicy
- MatchedValue
- StaticAssignment
- StaticGroupAssignment
- MatchedPolicyID
- NmapSubnetScanID
- PortalUser
- DeviceRegistrationStatus
- BYODRegistration

When you change endpoint profile definitions in Cisco ISE, all endpoints have to be reprofiled. A Policy Service node that collects the attributes of endpoints is responsible for reprofiling of those endpoints.

When a Policy Service node starts collecting attributes about an endpoint for which attributes were initially collected by a different Policy Service node, then the endpoint ownership changes to the current Policy Service node. The new Policy Service node will retrieve the latest attributes from the previous Policy Service node and reconcile the collected attributes with those attributes that were already collected.

When a significant attribute changes in the endpoint, attributes of the endpoint are automatically saved in the Administration node database so that you have the latest significant change in the endpoint. If the Policy Service node that owns an endpoint is not available for some reasons, then the Administrator ISE node will reprofile an endpoint that lost the owner and you have to configure a new Policy Service node for such endpoints.

## Policy Service Nodes in Cluster

Cisco ISE uses Policy Service node group as a cluster that allows to exchange endpoint attributes when two or more nodes in the cluster collect attributes for the same endpoint. We recommend to create clusters for all Policy Service nodes that reside behind a load balancer.

If a different node other than the current owner receives attributes for the same endpoint, it sends a message across the cluster requesting the latest attributes from the current owner to merge attributes and determine if a change of ownership is needed. If you have not defined a node group in Cisco ISE, it is assumed that all nodes are within one cluster.

There are no changes made to endpoint creation and replication in Cisco ISE. Only the change of ownership for endpoints is decided based on an allowed list of attributes used for profiling that are built from static attributes and dynamic attributes.

Upon subsequent attributes collection, the endpoint is updated on the Administration node, if anyone of the following attributes changes:

- ip
- EndPointPolicy
- MatchedValue
- StaticAssignment
- StaticGroupAssignment
- MatchedPolicyID
- NmapSubnetScanID
- PortalUser
- DeviceRegistrationStatus
- BYODRegistration

When an endpoint is edited and saved in the Administration node, the attributes are retrieved from the current owner of the endpoint.

## Create Endpoint Identity Groups

Cisco ISE groups endpoints that it discovers in to the corresponding endpoint identity groups. Cisco ISE comes with several system-defined endpoint identity groups. You can also create additional endpoint identity groups from the **Endpoint Identity Groups** window. You can edit or delete the endpoint identity groups that you have created. You can only edit the description of the system-defined endpoint identity groups. You cannot edit the name of these groups or delete them.

- 
- Step 1** Choose **Administration** > **Identity Management** > **Groups** > **Endpoint Identity Groups**.
  - Step 2** Click **Add**.
  - Step 3** Enter the **Name** for the endpoint identity group that you want to create (do not include spaces in the name of the endpoint identity group).
  - Step 4** Enter the **Description** for the endpoint identity group that you want to create.
  - Step 5** Click the **Parent Group** drop-down list to choose an endpoint identity group to which you want to associate the newly created endpoint identity group.
  - Step 6** Click **Submit**.
- 

## Identified Endpoints Grouped in Endpoint Identity Groups

Cisco ISE groups discovered endpoints into their corresponding endpoint identity groups based on the endpoint profiling policies. Profiling policies are hierarchical, and they are applied at the endpoint identify groups level in Cisco ISE. By grouping endpoints to endpoint identity groups, and applying profiling policies to endpoint identity groups, Cisco ISE enables you to determine the mapping of endpoints to the endpoint profiles by checking corresponding endpoint profiling policies.

Cisco ISE creates a set of endpoint identity groups by default, and allows you to create your own identity groups to which endpoints can be assigned dynamically or statically. You can create an endpoint identity

group and associate the identity group to one of the system-created identity groups. You can also assign an endpoint that you create statically to any one of the identity groups that exists in the system, and the profiling service cannot reassign the identity group.

## Default Endpoint Identity Groups Created for Endpoints

Cisco ISE creates the following endpoint identity groups:

- **blacklist:** This endpoint identity group includes endpoints that are statically assigned to this group in Cisco ISE and endpoints that are blocked in the device registration portal. An authorization profile can be defined in Cisco ISE to permit, or deny network access to endpoints in this group.
- **GuestEndpoints:** This endpoint identity group includes endpoints that are used by guest users.
- **Profiled:** This endpoint identity group includes endpoints that match endpoint profiling policies except Cisco IP phones and workstations in Cisco ISE.
- **RegisteredDevices:** This endpoint identity group includes endpoints, which are registered devices that are added by an employee through the devices registration portal. The profiling service continues to profile these devices normally when they are assigned to this group. Endpoints are statically assigned to this group in Cisco ISE, and the profiling service cannot reassign them to any other identity group. These devices will appear like any other endpoint in the endpoints list. You can edit, delete, and block these devices that you added through the device registration portal from the endpoints list in the Endpoints window in Cisco ISE. Devices that you have blocked in the device registration portal are assigned to the blacklist endpoint identity group, and an authorization profile that exists in Cisco ISE redirects blocked devices to a URL, which displays “Unauthorised Network Access”, a default portal page to the blocked devices.
- **Unknown:** This endpoint identity group includes endpoints that do not match any profile in Cisco ISE.

In addition to the above system created endpoint identity groups, Cisco ISE creates the following endpoint identity groups, which are associated to the Profiled (parent) identity group. A parent group is the default identity group that exists in the system:

- **Cisco-IP-Phone:** An identity group that contains all the profiled Cisco IP phones on your network.
- **Workstation:** An identity group that contains all the profiled workstations on your network.

## Endpoint Identity Groups Created for Matched Endpoint Profiling Policies

If you have an endpoint policy that matches an existing policy, then the profiling service can create a matching endpoint identity group. This identity group becomes the child of the Profiled endpoint identity group. When you create an endpoint policy, you can check the Create Matching Identity Group check box in the Profiling Policies page to create a matching endpoint identity group. You cannot delete the matching identity group unless the mapping of the profile is removed.

## Add Static Endpoints in Endpoint Identity Groups

You can add or remove statically added endpoints in any endpoint identity group.

You can add endpoints from the Endpoints widget only to a specific identity group. If you add an endpoint to the specific endpoint identity group, then the endpoint is moved from the endpoint identity group where it was dynamically grouped earlier.

Upon removal from the endpoint identity group where you recently added an endpoint, the endpoint is reprofiled back to the appropriate identity group. You do not delete endpoints from the system but only remove them from the endpoint identity group.

- 
- Step 1** Choose **Administration > Identity Management > Groups > Endpoint Identity Groups**.
  - Step 2** Choose an endpoint identity group, and click **Edit**.
  - Step 3** Click **Add**.
  - Step 4** Choose an endpoint in the Endpoints widget to add the selected endpoint in the endpoint identity group.
  - Step 5** Click the **Endpoint Group List** link to return to the Endpoint Identity Groups page.
- 

### Dynamic Endpoints Reprofiled After Adding or Removing in Identity Groups

If an endpoint identity group assignment is not static, then endpoints are reprofiled after you add or remove them from an endpoint identity group. Endpoints that are identified dynamically by the ISE profiler appear in appropriate endpoint identity groups. If you remove dynamically added endpoints from an endpoint identity group, Cisco ISE displays a message that you have successfully removed endpoints from the identity group but reprofiles them back in the endpoint identity group.

### Endpoint Identity Groups Used in Authorization Rules

You can effectively use endpoint identity groups in the authorization policies to provide appropriate network access privileges to the discovered endpoints. For example, an authorization rule for all types of Cisco IP Phones is available by default in Cisco ISE in the following location: **Policy > Authorization > Standard**.

You must ensure that the endpoint profiling policies are either standalone policies (not a parent to other endpoint profiling policies), or their parent policies of the endpoint profiling policies are not disabled.

## Anycast and Profiler Services

Anycast is a networking technique where the same IP address is assigned to two or more hosts and routing is allowed to determine the most appropriate target to receive the data. Similar to the load balancer use cases to provide a single target for profiling data (RADIUS, DHCP relay, SNMP traps, and NetFlow), Anycast allows the sources to be configured with a single IP target to avoid sending the same data to multiple destinations.

The Anycast IP address can be assigned to a real PSN interface IP address or a load balancer virtual IP address to support redundancy across data centers. You must not assign the Anycast IP address to ISE Gigabit Ethernet 0 management interface.

The interface used for Anycast must be a dedicated interface used by the Profiler probe. The same requirement does not apply when the Anycast IP address is assigned to a load balancer virtual IP address.

When using Anycast, it is critical that any node failure be automatically detected and the corresponding route to the failed node be removed from the routing table. If an Anycast target is the only host on the link or VLAN, then failure may result in route being automatically removed.

When IP Anycast is deployed, it is very important to ensure that the route metrics to each target have significant weighting or bias. If the routes to Anycast targets flap or result in an Equal-Cost Multi-Path Routing (ECMP) scenario, then traffic for a given service (RADIUS AAA, DHCP or SNMP Trap Profiling, HTTPS portals) may be distributed to each target resulting in excessive traffic and service failures (RADIUS AAA and HTTPS portals) or suboptimal profiling and database replication (profiling services).

The key advantage of IP Anycast is that it greatly simplifies the configuration on access devices, profile data sources, and DNS. It can also optimize ISE profiling by ensuring that the data for a given endpoint is sent only to a single PSN. Additional route configuration must be carefully planned and managed with appropriate monitors. However, troubleshooting might be difficult because distinct subnetworks and IP addresses are not used.



## CHAPTER 25

# Configure Client Provisioning

- [Configure Client Provisioning in Cisco ISE, on page 707](#)
- [Client Provisioning Resources, on page 708](#)
- [Add Client Provisioning Resources from Cisco, on page 709](#)
- [Add Cisco Provided Client Provisioning Resources from a Local Machine, on page 710](#)
- [Add Customer Created Resources for AnyConnect from a Local Machine, on page 710](#)
- [Create Native Supplicant Profiles, on page 711](#)
- [Client Provisioning Without URL Redirection for Different Networks, on page 713](#)
- [AMP Enabler Profile Settings, on page 714](#)
- [Cisco ISE Support for Onboarding Chromebook Devices, on page 717](#)
- [Create AnyConnect Configuration, on page 729](#)
- [Create a Posture Agent Profile, on page 730](#)
- [Client IP Address Refresh Configuration, on page 730](#)
- [Posture Protocol Settings, on page 733](#)
- [Client Login Session Criteria, on page 733](#)
- [Provision Client Machines with the Cisco NAC Agent MSI Installer, on page 734](#)
- [Cisco ISE Posture Agents, on page 735](#)
- [Cisco AnyConnect Secure Mobility, on page 737](#)
- [Cisco NAC Agent XML File Installation Directories, on page 737](#)
- [Cisco NAC Agent for Windows Clients, on page 737](#)
- [Cisco NAC Agent for Macintosh Clients, on page 739](#)
- [Cisco Web Agent, on page 739](#)
- [Cisco NAC Agent Logs, on page 740](#)
- [Create an Agent Customization File for the Cisco NAC Agent, on page 740](#)
- [Configure Client Provisioning Resource Policies, on page 753](#)
- [Client Provisioning Reports, on page 755](#)
- [Client Provisioning Event Logs, on page 756](#)

## Configure Client Provisioning in Cisco ISE

Enable client provisioning to allow users to download client provisioning resources and configure agent profiles. You can configure agent profiles for Windows clients, Mac OS X clients, and native supplicant profiles for personal devices. If you disable client provisioning, users attempting to access the network will receive a warning message indicating that they are not able to download client provisioning resources.

**Before you begin**

If you are using a proxy and hosting client provisioning resources on a remote system, verify that the proxy allows clients to access that remote location.

- 
- Step 1** Choose **Administration > System > Settings > Client Provisioning** .
- Step 2** From the **Enable Provisioning** drop-down list, choose **Enable** or **Disable**.
- Step 3** From the **Enable Automatic Download** drop-down list, choose **Enable**.

Feed downloads include all the available client provisioning resources. Some of these resources may not be pertinent to your deployment. Cisco recommends manually downloading resources whenever possible instead of setting this option.

- Step 4** Specify the URL where Cisco ISE searches for system updates in the **Update Feed URL** text box. For example, the default URL for downloading client-provisioning resources is <https://www.cisco.com/web/secure/pmbu/provisioning-update.xml>.

If your network restricts URL-redirectation functions (via a proxy server, for example) and you are experiencing difficulty accessing the default URL, try also pointing your Cisco ISE to the following URL:  
<https://www.perfigo.com/ise/provisioning-update.xml>.

- Step 5** When there is no client provisioning resource for a device, choose one of the following options:

- **Allow Network Access:** Users are allowed to register their device on the network without having to install and launch the native supplicant wizard.
- **Apply Defined Authorization Policy:** Users must try to access the Cisco ISE network via standard authentication and authorization policy application (outside of the native supplicant provisioning process). If you enable this option, the user device goes through standard registration according to any client-provisioning policy applied to the user's ID. If the user's device requires a certificate to access the Cisco ISE network, you must also provide detailed instructions to the user describing how to obtain and apply a valid certificate using the customizable user-facing text fields.

- Step 6** Click **Save**.
- 

**What to do next**

Configure client provisioning resource policies.

## Client Provisioning Resources

Client provisioning resources are downloaded to endpoints after the endpoint connects to the network. Client provisioning resources consist of compliance and posture agents for desktops, and native supplicant profiles for phones and tablets. Client provisioning policies assign these provisioning resources to endpoints to start a network session.

Client provisioning resources are listed on **Policy Elements > Results > Client Provisioning > Resources**. The following resource types can be added to the list by clicking the **Add** button:

- **Agent resources from Cisco Site:** Select the NAC, AnyConnect and supplicant provisioning wizards you want to make available for client provisioning policies. Cisco periodically updates this list of resources, adding new ones and updating existing ones. You can also set up ISE to download all the Cisco resources



and resource updates automatically, see [Configure Client Provisioning in Cisco ISE, on page 707](#) for more information.

- **Agent resources from local disk:** Select resources on your PC that you want to upload to ISE, see [Add Cisco Provided Client Provisioning Resources from a Local Machine, on page 710](#).
- 
- **Native Supplicant Profile:** Configure a supplicant profile for phones and tablets that contain settings for your network. For more information, see [Create Native Supplicant Profiles](#).
- **NAC Agent or AnyConnect ISE Posture Profile:** Configure the NAC agent and AnyConnect ISE Posture here when you don't want to create and distribute agent XML profiles. For more information about the AnyConnect ISE Posture agent and ISE Posture Profile Editor, see the AnyConnect Administrators Guide for your version of AnyConnect <https://www.cisco.com/c/en/us/support/security/anyconnect-secure-mobility-client/products-installation-and-configuration-guides-list.html>. For more information about the NAC agent profile, see [Create an Agent Customization File for the Cisco NAC Agent, on page 740](#).

After creating client provisioning resources, create client provisioning policies that apply the client provisioning resources to the endpoints. See [Configure Client Provisioning Resource Policies, on page 753](#).

#### Related Topics

[Configure Client Provisioning in Cisco ISE, on page 707](#)

[Add Client Provisioning Resources from Cisco, on page 709](#)

[Add Cisco Provided Client Provisioning Resources from a Local Machine, on page 710](#)

[Add Customer Created Resources for AnyConnect from a Local Machine, on page 710](#)

## Add Client Provisioning Resources from Cisco

You can add client provisioning resources from Cisco.com for AnyConnect and Cisco NAC Agents for Windows, MAC OSX clients, and Cisco Web agent. Depending on the resources that you select and available network bandwidth, Cisco ISE can take a few minutes to download client provisioning resources to Cisco ISE.

#### Before you begin

- Ensure that you have configured the correct proxy settings in Cisco ISE.
- Enable client provisioning in Cisco ISE.

- 
- Step 1** Choose **Policy > Policy Elements > Results > Client Provisioning > Resources**.
  - Step 2** Choose **Add > Agent resources from Cisco site**.
  - Step 3** Select one or more required client provisioning resources from the list available in the **Download Remote Resources** dialog box.
  - Step 4** Click **Save**.
-

**What to do next**

After you have successfully added client provisioning resources to Cisco ISE, you can begin to configure client provisioning resource policies.

## Add Cisco Provided Client Provisioning Resources from a Local Machine

You can add client provisioning resources from the local disk, which you previously downloaded from Cisco.

**Before you begin**

Be sure to upload only current, supported resources to Cisco ISE. Older, unsupported resources are likely to cause serious issues for client access.

If you are downloading the resource files manually from the Cisco.com, see the Section “Cisco ISE Offline Updates” in the [Cisco ISE Release Notes](#).

- 
- Step 1** Choose **Policy > Policy Elements > Results > Client Provisioning > Resources**.
- Step 2** Choose **Add > Agent resources from local disk**.
- Step 3** Choose **Cisco Provided Packages** from the **Category** drop-down list.
- Step 4** Click **Browse** to the directory on your local machine where the resource file that you want to download to Cisco ISE resides.
- You can add AnyConnect , Cisco NAC Agent, or Cisco Web Agent resources that you previously downloaded from Cisco to your local machine.
- Step 5** Click **Submit**.
- 

**What to do next**

After you have successfully added client provisioning resources to Cisco ISE, you can configure client provisioning resource policies.

## Add Customer Created Resources for AnyConnect from a Local Machine

Add customer created resources like AnyConnect customization and localization packages and AnyConnect profiles from the local machine to Cisco ISE.

**Before you begin**

Ensure that customer created resources for AnyConnect are zipped files and available in your local disk.

- 
- Step 1** Choose **Policy > Policy Elements > Results > Client provisioning > Resources**.

- Step 2** Choose **Add > Agent Resources from local disk**.
- Step 3** Choose **Customer Created Packages** from the **Category** drop-down list.
- Step 4** Enter the name and description for AnyConnect resources.
- Step 5** Click **Browse** to the directory on your local machine where the resource file that you want to download to Cisco ISE resides.
- Step 6** Choose the following AnyConnect resources to upload to Cisco ISE:
- AnyConnect customization bundle
  - AnyConnect localization bundle
  - AnyConnect profile
  - Advanced Malware Protection (AMP) Enabler Profile
- Step 7** Click **Submit**.  
The Uploaded AnyConnect Resources table displays AnyConnect resources that you add to Cisco ISE.

---

#### What to do next

Create AnyConnect agent profile

## Create Native Supplicant Profiles

You can create native supplicant profiles to enable users to bring their own devices into the Cisco ISE network. When the user signs in, Cisco ISE uses the profile that you associated with that user's authorization requirements to choose the necessary supplicant provisioning wizard. The wizard runs and sets up the user's personal device to access the network.



---

**Note** The provisioning wizard only configures interfaces which are active. Because of this, users with Wired and Wireless connections will not be provisioned for both interfaces, unless they are both active.

---

#### Before you begin

- Open up TCP port 8905 to enable the installation of Cisco AnyConnect Agent, Cisco Web Agent, and supplicant provisioning wizard. For more information about port usage, see the "Cisco ISE Appliance Ports Reference" appendix in the *Cisco Identity Services Engine Hardware Installation Guide*.

- 
- Step 1** Choose **Policy > Policy Elements > Results > Client Provisioning > Resources**.
- Step 2** Choose **Add > Native Supplicant Profile**.
- Step 3** Create a profile, using the procedure described in [Native Supplicant Profile Settings, on page 712](#) .
- 

#### What to do next

Enable self-provisioning capabilities that allow employees to directly connect their personal devices to the network, as described in the Support for multiple Guest Portals section.

## Native Supplicant Profile Settings

When you choose **Policy > Policy Elements > Results > Client Provisioning > Resources > Add > Native Supplicant Profile**. The following settings are displayed.

- **Name:** Enter the name of the native supplicant profile that you are creating.
- **Operating System:** Choose which operating system(s) this profile should apply to from the drop-down list.

Each profile defines the settings for a network connection that Cisco ISE will apply to the client's native supplicant.

### Wireless Profile

Configure a wireless profile, one for each SSID that you want to make available to the client:

- **SSID Name:** Enter the name of the SSID that the client will connect to.
- **Proxy Auto-Config File URL:** If the client will connect to a proxy to get the network configuration for its supplicant, enter the URL of that proxy server.
- **Proxy Host/IP:** If the client will connect to a proxy to get the network configuration for its supplicant, enter the Host/IP of that proxy server.
- **Proxy Port:** If the client will connect to a proxy to get the network configuration for its supplicant, enter the port of that proxy server.
- **Security:** Choose either **WPA** or **WPA2**.
- **Allowed Protocol:** Choose either **PEAP** or **EAP-TLS**.
- **Certificate Template:** For TLS, choose one of the certificate templates. The certificate templates are defined in **Administration > System Certificates > Certificate Authority > Certificate Templates**.

### Optional Settings

If you expand **Optional**, the following fields are displayed.

#### Windows Settings

- **Authentication Mode:** Choose **User**, **Machine** or **both** as credentials for authorization.
- **Do not prompt user to authorize new servers or trusted certification authorities:** If this option is enabled, the user is not prompted to authorize. User certificates are automatically accepted.
- **Use a different user name for the connection:** This is applicable only for wireless profiles. Use a different user name for the connection.
- **Connect even if the network is not broadcasting its name (SSID):** This is applicable only for wireless profiles. Connect to a network even when its SSID is not being broadcasted.

#### iOS Settings

- **Enable if target network is hidden:** Check this check box if the target network is hidden.

### Wired Profile

- **Allowed Protocol:** Choose either **PEAP** or **EAP-TLS**.
- **Certificate Template:** For TLS, choose one of the certificate templates. The certificate templates are defined in **Administration > System Certificates > Certificate Authority > Certificate Templates**.

### Optional Settings

If you expand **Optional**, the following fields are also available for Windows clients.

- **Authentication Mode:** Choose **User**, **Machine** or **both** as credentials for authorization.
- **Automatically use logon name and password (and domain if any):** If you selected **User** for **Authentication Mode**, use the logon and password to without prompting the user, if that information is available.
- **Enable Fast Reconnect:** Allow a PEAP session to resume without checking user credentials when the session resume feature is enabled in the PEAP protocol options, which is configured on **Administration > System > Settings > Protocols > PEAP**.
- **Enable Quarantine Checks:** Check if the client has been quarantined.
- **Disconnect if server does not present cryptobinding TLV:** Disconnect if cryptobinding TLV is not supported for the network connection.
- **Do not prompt user to authorize new servers or trusted certification authorities:** Automatically accept user certificates; do not prompt the user.

## Client Provisioning Without URL Redirection for Different Networks

Client provisioning without URL redirection is required when the third party NAC does not support CoA. You can perform client provisioning with and without URL redirection.



- Note** For client provisioning with URL redirection, if the client machine has proxy settings configured, ensure that you add Cisco ISE to the list of exceptions in the browser settings. This setting is applicable for all flows, BYOD, MDM, Guest, and Posture that use URL redirection. For example, on Windows machines, do the following:
1. From Control Panel, click **Internet Properties**.
  2. Select the **Connections** tab.
  3. Click **LAN settings**.
  4. Click **Advanced** from the Proxy server area.
  5. Enter the IP addresses of the Cisco ISE nodes in the **Exceptions** box.
  6. Click **OK**.

Given below are the steps you perform to provision an endpoint without redirection for different networks.

#### Dot1X EAP-TLS

1. Connect the Cisco ISE network with provisioned certification.
2. Open a browser window and type in the provisioning URL: provisioning.cisco.com.
3. Log into the CP portal via internal user, AD, LDAP, or SAML.  
AnyConnect performs posture. The endpoint moves to the right network based on posture compliance.

#### Dot1X PEAP

1. Connect the Cisco ISE network with User Name and Password through NSP
2. Open a browser window and type in the provisioning URL: provisioning.cisco.com.
3. Log into the CP portal via internal user, AD, LDAP, or SAML  
AnyConnect performs posture. The endpoint moves to the right network based on posture compliance.

#### MAB (Wired Networks)

1. Connect the Cisco ISE network.
2. Open a browser window and type in the provisioning URL: provisioning.cisco.com.
3. Log into the CP portal via internal user, AD, LDAP, or SAML.  
AnyConnect performs posture. The endpoint moves to the right network based on posture compliance.

#### MAB (Wireless Networks)

1. Connect the Cisco ISE network
2. Open a browser window and type in the provisioning URL: provisioning.cisco.com.
3. Log into the CP portal via internal user, AD, LDAP, or SAML.  
AnyConnect performs posture. Posture starts for wireless 802.1X only.

## AMP Enabler Profile Settings

The following table describes the fields in the Advanced Malware Protection (AMP) Enabler Profile window. The navigation path is: **Policy > Policy Elements > Results > Client Provisioning > Resources**.

Click the **Add** drop-down arrow and select the **AMP Enabler Profile**.

*Table 64: AMP Enabler Profile Page*

| Field Names        | Usage Guidelines                                                   |
|--------------------|--------------------------------------------------------------------|
| <b>Name</b>        | Enter the name of the AMP enabler profile that you want to create. |
| <b>Description</b> | Enter a description for the AMP enabler profile.                   |

| Field Names                  | Usage Guidelines                                                                                                                                                                                                                                                                                                                                                                                                                                                                                                                                                                                                                                                                                              |
|------------------------------|---------------------------------------------------------------------------------------------------------------------------------------------------------------------------------------------------------------------------------------------------------------------------------------------------------------------------------------------------------------------------------------------------------------------------------------------------------------------------------------------------------------------------------------------------------------------------------------------------------------------------------------------------------------------------------------------------------------|
| <b>Install AMP Enabler</b>   | <ul style="list-style-type: none"> <li>• <b>Windows Installer:</b> Specify the URL of the local server that hosts the AMP for Windows OS software. The AnyConnect module uses this URL to download the .exe file to the endpoint. The file size is approximately 25 MB.</li> <li>• <b>Mac Installer:</b> Specify the URL of the local server that hosts the AMP for macOS software. The AnyConnect module uses this URL to download the .pkg file to the endpoint. The file size is approximately 6 MB.</li> </ul> <p>The <b>Check</b> button communicates with the server to verify if the URL is valid. If the URL is valid, a "File found" message is displayed or else an error message is displayed.</p> |
| <b>Uninstall AMP Enabler</b> | Uninstalls the AMP for endpoint software from the endpoint.                                                                                                                                                                                                                                                                                                                                                                                                                                                                                                                                                                                                                                                   |
| <b>Add to Start Menu</b>     | Adds a shortcut for the AMP for endpoint software in the Start menu of the endpoint, after the AMP for endpoint software is installed on the endpoint.                                                                                                                                                                                                                                                                                                                                                                                                                                                                                                                                                        |
| <b>Add to Desktop</b>        | Adds an icon for the AMP for endpoint software on the desktop of the endpoint, after the AMP for endpoint software is installed on the endpoint.                                                                                                                                                                                                                                                                                                                                                                                                                                                                                                                                                              |
| <b>Add to Context Menu</b>   | Adds the Scan Now option in the right-click context menu of the endpoint, after the AMP for endpoint software is installed on the endpoint.                                                                                                                                                                                                                                                                                                                                                                                                                                                                                                                                                                   |

## Create an AMP Enabler Profile Using the Embedded Profile Editor

You can create the AMP enabler profile using the Cisco ISE embedded profile editor or the standalone editor.

To create the AMP enable profile using the Cisco ISE embedded profile editor:

### Before you begin

- Download the AMP for Endpoint software from the SOURCEfire portal and host it on a local server.
- Import the certificate of the server that hosts the AMP for endpoint software to the ISE certificate store by navigating to **Administration > Certificates > Trusted Certificates**.
- Ensure that the **AMP Enabler** options are selected in the **AnyConnect Module Selection** and **Profile Selection** sections in the **AnyConnect Configuration** window ( **Policy > Policy Elements > Results > Client provisioning > Resources > Add > AnyConnect Configuration > Select AnyConnect Package** ).
- You must log in to the SOURCEfire portal, create policies for endpoint groups, and download the AMP for endpoint software. The software comes preconfigured with the policies that you have chosen. You

must download two images, namely, the redistributable version of the AMP for endpoint software for Windows OS and AMP for endpoint software for macOS. The downloaded software is hosted on a server that is accessible from the enterprise network.

- 
- Step 1** Choose **Policy > Policy Elements > Results > Client Provisioning > Resources**.
  - Step 2** Click the **Add** drop-down.
  - Step 3** Choose **AMP Enabler Profile** to create a new AMP enabler profile.
  - Step 4** Enter the appropriate values in the fields.
  - Step 5** Click **Submit** to save the profile in the **Resources** window.
- 

## Create an AMP Enabler Profile Using the Standalone Editor

To create an AMP enabler profile using the AnyConnect standalone editor.

### Before you begin

You can create an AMP enabler profile by uploading the XML format of the profile using the AnyConnect 4.1 standalone editor.

- Download the AnyConnect standalone profile editor for Windows and Mac OS from Cisco.com.
- Launch the standalone profile editor and enter the fields as specified in the [AMP Enabler Profile Settings](#).
- Save the profile as an XML file in your local disk.
- Ensure that the **AMP Enabler** options are selected in the **AnyConnect Module Selection** and **Profile Selection** sections in the **AnyConnect Configuration** window ( **Policy > Policy Elements > Results > Client provisioning > Resources > Add > AnyConnect Configuration > Select AnyConnect Package**).

- 
- Step 1** Choose **Policy > Policy Elements > Results > Client provisioning > Resources**.
  - Step 2** Click **Add**.
  - Step 3** Choose **Agent resources from local disk**.
  - Step 4** Choose **Customer Created Packages** from the **Category** drop-down.
  - Step 5** Choose **AMP Enabler Profile** from the **Type** drop-down.
  - Step 6** Enter a **Name** and **Description**.
  - Step 7** Click **Browse** and select the saved profile (XML file) from the local disk. The following example shows a customized install file.

```
<?xml version="1.0" encoding="UTF-8"?>
<FAProfile xsi:noNamespaceSchemaLocation="FAProfile.xsd"
xmlns:xsi="http://www.w3.org/2001/XMLSchema-instance">
 <FAConfiguration>
 <Install>
 <WindowsConnectorLocation>
https://fa_webserver/ACFA_Mac_FireAMPSetup.exe
 </WindowsConnectorLocation>
 <MacConnectorLocation>
https://fa_webserver/ACFA_Mac_FireAMPSetup.exe
```



```
</MacConnectorLocation>
<StartMenu>true</StartMenu>
<DesktopIcon>false</DesktopIcon>
<ContextIcon>true</ContextIcon>
</Install>
</FAConfiguration>
</FAProfile>
```

The following example shows a customized uninstall file.

```
<?xml version="1.0" encoding="UTF-8"?>
<FAProfile xsi:noNamespaceSchemaLocation="FAProfile.xsd"
xmlns:xsi="http://www.w3.org/2001/XMLSchema-instance">
 <FAConfiguration>
 <Uninstall>
 </Uninstall>
 </FAConfiguration>
</FAProfile>
```

**Step 8** Click **Submit**.

The newly created AMP Enabler profile is displayed in the **Resources** page.

## Troubleshoot Common AMP Enabler Installation Errors

When you enter the SOURCEfire URL in the Windows or MAC Installer text box and click **Check**, you might encounter any of the following errors:

- Error Message: The certificate for the server containing the Mac/Windows installer file is not trusted by ISE. Add a trust certificate to **Administration > Certificates > Trusted Certificates**.

This error message appears if you have not imported the SOURCEfire trusted certificate in to the Cisco ISE certificate store. Obtain a SOURCEfire trusted certificate and import it in to the Cisco ISE trusted certificate store (Administration > Certificates > Trusted Certificates).

- Error Message: The installer file is not found at this location, this may be due to a connection issue. Enter a valid path in the Installer text box or check your connection.

This error message appears when the server hosting the AMP for Endpoint software is down or if there is a typographic error in the Windows Installer or MAC Installer text box.

- Error Message: The Windows/Mac installer text box does not contain a valid URL.

This error message appears when you enter a syntactically incorrect URL format.

## Cisco ISE Support for Onboarding Chromebook Devices

Chromebook devices are managed devices (managed by the Google domain), unlike other devices (Apple, Windows, Android) and have limited onboarding support. Cisco ISE supports the onboarding of Chromebook devices on a network. Onboarding refers to the process of delivering the required settings and files to an endpoint such that it is able to connect securely to a network after authenticating with Cisco ISE. This process includes certificate provisioning and/or native supplicant provisioning. However, in Chromebook devices, you can only perform certificate provisioning. Native supplicant provisioning is done via the Google Admin Console.

Unmanaged Chromebook devices cannot be onboarded to a secure network.

The entities involved in the Chromebook onboarding process are the:

- Google Administrator
- ISE Administrator
- Chromebook User/Device
- Google Admin Console (Managed by the Google Administrator)

The Google administrator:

- Secures the following licenses:
  1. Google Apps Administrator license for the Google Admin Console configuration—URL: <https://admin.google.com>. The Google Admin Console enables an administrator to manage Google services for people in an organization.
  2. Chromebook device management license—URL: <https://support.google.com/chrome/a/answer/2717664?hl=en>. A Chromebook device management license is used to configure settings and enforce policies for a specific Chromebook device. It gives the Google Administrator access to device settings to control user access, customize features, configure network access, and more.
- Facilitates provisioning and enrolling of Chromebook devices with a Google device license.
- Manages Chromebook devices through the Google Admin Console.
- Sets up and manages the Wi-Fi network configuration for each Chromebook user.
- Manages the Chromebook devices by configuring applications and forced extensions to be installed on the Chromebook device. Onboarding the Chromebook device requires the Cisco Network Setup Assistant extensions to be installed in the Chromebook device. This allows the Chromebook device to connect to Cisco ISE and install the ISE certificate. The extension is forcibly installed because the action of certificate installation is allowed only for managed devices.
- Ensures that the Cisco ISE certificates are installed in the Google Admin Console to provide server validation and secure connection. The Google administrator decides whether a certificate should be generated for a device or a user. Cisco ISE provides options to:
  - Generate the certificate for a single user who does not share the Chromebook device.
  - Generate a certificate for a Chromebook device that is shared by multiple users. Refer to Step 5 in the [Configure the Network and Force Extensions in the Google Admin Console](#) section for the required additional configuration.

The Google Administrator installs the ISE server certificate so that ISE is trusted to perform the certificate provisioning on the Chromebook device and also to allow EAP-TLS certificate-based authentication. Google Chrome version 37 and higher supports certificate-based authentication for Chromebook devices. The google administrator needs to load the ISE provisioning application in the Google Admin Console and make it available to the Chromebook devices to get the certificate from ISE.

- Ensures that the recommended Google host names are allowed in the ACL definition list configured in the WLC for SSL secure connections. Refer to the recommended and allowed host names in the [Google Support](#) page.

The ISE Administrator:

- Defines the native supplicant profile for the Chromebook OS that includes the certificate template structure.
- Creates the necessary authorization rules and client provisioning policies in Cisco ISE for Chromebook users.

The Chromebook User:

- Wipes out the Chromebook device and enrolls it to the Google domain to secure the enforced policy that was defined by the Google administrator.
- Receives the Chromebook device policies and the Cisco Network Setup Assistant forced extension installed by the Google Admin Console.
- Connects to the provisioned SSID, as defined by the Google administrator, opens the browser, displays the BYOD pages, and starts the onboarding process.
- The Cisco Network Setup Assistant installs a client certificate in the Chromebook device, which allows the device to perform EAP-TLS certificate-based authentication.

The Google Admin Console:

The Google Admin Console supports Chromebook device management and allows configuring a secure network and pushing Cisco Network Setup Assistant certificate management extensions to the Chromebook. The extension sends an SCEP request to Cisco ISE and installs the client certificate to allow secure connection and access to the network.

## Best Practices for Using Chromebook Device in a Shared Environment

When a Chromebook device is used in a shared environment, such as schools and libraries, the Chromebook device is shared by different users. Some of the best practices that Cisco recommends include:

- When onboarding a Chromebook device with a specific user (student or professor) name, the user's name will be populated in the Common Name (CN) in the Subject field of the certificate. Also, the shared Chromebook is listed in the My Devices portal under that specific user. Therefore, it is recommended for shared devices to use a shared credential when onboarding, so that devices show up only under the specific user's My Devices portal listing. The shared account can be administered by the administrator or professor as a separate account to control shared devices.
- The Cisco ISE administrator can create a custom certificate template for shared Chromebook devices and use it in the policy. For example, instead of using the standard certificate template that matches the Subject-Common Name (CN) value, you can specify a Name (for example, chrome-shared-grp1) in the certificate and the same name can be assigned to the Chromebook device. A policy can be designed to match the name to allow or deny access to a Chromebook device.
- The Cisco ISE administrator can create an endpoint group with all the Chromebook devices' MAC addresses that needs to go through Chromebook onboarding (devices for which access need to be restricted). The authorization rule should call this out along with device type Chromebook—this would allow access to be redirected to the NSP.

## Chromebook Onboarding Process

The Chromebook onboarding process involves a series of steps:

- 
- Step 1** [Configure the Network and Force Extensions in the Google Admin Console](#) .
  - Step 2** [Configure Cisco ISE for Chromebook Onboarding](#).
  - Step 3** [Wipe a Chromebook Device](#).
  - Step 4** [Enroll Chromebook to the Google Admin Console](#).
  - Step 5** [Connect Chromebook to the Cisco ISE Network for BYOD On Boarding](#).
- 

## Configure the Network and Force Extensions in the Google Admin Console

The Google administrator performs the following steps.

- 
- Step 1** Log in to the Google Admin Console.
    - a) Enter the following URL: <https://admin.google.com> in the browser.
    - b) Enter the required username and password.
    - c) In the **Welcome to Admin Console** window, click **Device Management**.
    - d) On the **Device Management** window, click **Network**.
  - Step 2** Set up the Wi-Fi network for managed devices.
    - a) In the **Networks** window, click **Wi-Fi**.
    - b) Click **Add Wi-Fi** to add the required SSIDs. See [Google Admin Console - Wi-Fi Network Settings](#) for more information.
 

For MAB flows, create two SSIDs, one for the open network, and the other for certificate authentication. When you connect to the open network, Cisco ISE ACLs redirect you to the credentialed guest portal for authentication. After successful authentication, ACLs redirect you to the BYOD portal.

If the ISE certificate is issued by an intermediate CA, then you must map the intermediate certificate to the "Server certificate authority", instead of to the Root CA.
    - c) Click **Add**.
  - Step 3** Create the forced extensions.
    - a) In the **Device Management** window, under the **Device Settings** , click **Chrome Management**.
    - b) Click **User Settings**.
    - c) Scroll down, and in the **Apps and Extensions** section, in the **Force-Installed Apps and Extensions** option, click **Manage Force-Installed Apps**.
  - Step 4** Install the forced extensions.
    - a) In the **Force-Installed Apps and Extensions** window, click **Chrome Web Store**.
    - b) In the **Search** text box, type "Cisco Network Setup Assistant" to locate the extension.
 

The forced Cisco Network Setup Assistant extension of the Chromebook device requests the certificate from Cisco ISE, and installs the ISE certificate on the Chromebook device. The extension must be configured as force-installed because certificate installation is only allowed for managed devices. If the extension was not installed during the enrollment process, the Cisco ISE certificate cannot be installed.

See [Cisco ISE Internationalization and Localization](#) for more information about the languages that are supported by extensions.

- c) Click **Add** to force install apps.
- d) Click **Save**.

**Step 5** (Optional) Define the configuration file to install a certificate in a Chromebook device which is shared by multiple users.

- a) Copy and paste the following code in a Notepad file and save it to your local disk.

```
{
 "certType": {
 "Value": "system"
 }
}
```

- b) Choose **Device Management > Chromebook Management > App Management**.
- c) Click the **Cisco Network Setup Assistant** extension.
- d) Click **User Settings** and choose your domain.
- e) Click **Upload Configuration File** and choose the .txt file that you saved in your local disk.

**Note** In order for the Cisco Network Setup Assistant to create a certificate for a device that is shared by multiple users, you must add the Notepad file in the Google Admin Console. Otherwise, the Cisco NSA creates a certificate for a single user.

- f) Click **Save**.

**Step 6** (Optional) Install a certificate for a single user who does not share the Chromebook.

- a) Choose **Device Management > Network > Certificates**.
- b) In the **Certificates** window, click **Add Certificate** and upload the Cisco ISE certificate file.

---

### What to do next

Configure Cisco ISE for Chromebook on board.

## Configure Cisco ISE for Chromebook Onboarding

### Before you begin

The Cisco ISE administrator must create the required policy in the **Policy > Authorization** window.

Given below is an example of an authorization policy:

Rule Name: Full\_Access\_After\_Onboarding, Conditions: If RegisteredDevices AND Wireless\_802.1x AND Endpoints:BYODRegistration EQUALS Yes AND Certificate: Subject Alternative Name Equals RadiusCalling-Station-ID AND Network Access: EAP-Authentication EQUALS EAP-TLS Then CompliantNetworkAccess.

The CompliantNetworkAccess is an authorization result configured in the **Policy > Policy Elements > Results > Authorization > Authorization Profiles** window.

---

**Step 1** Configure the Native Supplicant Profile (NSP) on Cisco ISE.

- a) Choose **Policy > Policy Elements > Results > Client Provisioning > Resources**.

The Chromebook device is displayed in the Client Provisioning page for a fresh Cisco ISE installation. However, for upgrade, you should download posture updates from the **Administration > System > Settings > Posture > Updates** window.

- b) Click **Add > Native Supplicant Profile**.
- c) Enter the **Name** and **Description**.
- d) In the **Operating System** field, choose **Chrome OS All**.
- e) In the **Certificate Template** field, select the required certificate template.
- f) Click **Submit**. Observe that the SSID is provisioned via the Google Admin Console and not through the native supplicant provisioning flow.

**Step 2** Map the NSP in the Client Provisioning page.

- a) Choose **Policy > Client Provisioning**.
- b) Define the result.
  - Choose the in-built Native Supplicant configuration (Cisco-ISE-Chrome-NSP) in the **Results** of the client provisioning policy.
  - Or, create a new rule and ensure to choose the **Result** created for the Chromebook device.

---

## Wipe a Chromebook Device

The Chromebook device must be wiped after the Google Admin Console is configured by the Google Administrator. The Chromebook user must wipe the device, which is a one-time process, to force extensions and configure the network settings. You can refer to the following URL: <https://support.google.com/chrome/a/answer/1360642> for further information.

The Chromebook user performs the following steps:

- 
- Step 1** Press **Esc-Refresh-Power** key combination. The screen displays a yellow exclamation point (!).
  - Step 2** Press **Ctrl -D** key combination to begin dev mode, then press **Enter** key. The screen displays a red exclamation point.
  - Step 3** Press **Ctrl -D** key combination. The Chromebook deletes its local data, returning to its initial state. The deletion takes approximately 15 minutes.
  - Step 4** When the transition completes, press the **Spacebar** key, then press the **Enter** key to return to verified mode.
  - Step 5** Enroll the Chromebook before signing in.
- 

### What to do next

Enroll Chromebook to the Google Admin Console.

## Enroll Chromebook to the Google Admin Console

In order to provision a Chromebook device, the Chromebook user must first enroll in the Google Admin Console page and receive device policies and forced extensions.

- 
- Step 1** Turn on the Chromebook device and follow the onscreen instructions until you see the sign on screen. Do not sign in yet.
- Step 2** Before signing in to the Chromebook device, press **Ctrl-Alt-E** key combination. The **Enterprise Enrolment** screen appears.
- Step 3** Enter your email address and click **Next**.  
You will receive the following message: Your device has successfully been enrolled for enterprise management.
- Step 4** Click **Done**.
- Step 5** Enter the username and password from your Google admin welcome letter, or the username and password for an existing Google Apps user on your account that has eligibility to enroll.
- Step 6** Click **Enroll Device**. You will receive a confirmation message that the device has been successfully enrolled.  
Note that the Chromebook enrollment is a one-time process.
- 

## Connect Chromebook to the Cisco ISE Network for BYOD On Boarding

The procedure is for Dual SSID—To connect to a 802.x network using the EAP-TLS protocol, the Chromebook user performs the following steps:



---

**Note** If you are using Dual SSID—When connecting from 802.x PEAP to an EAP-TLS network, connect to the network by entering your credentials in the network supplicant, not the web browser.

---

- 
- Step 1** In the Chromebook, click **Settings**.
- Step 2** In the **Internet Connection** section, click **Provisioning Wi-Fi Network**, and then click your network.
- Step 3** The credentialed guest portal opens.
- On the Sign On page, enter the **Username** and **Password**.
  - Click **Sign-on**.
- Step 4** In the BYOD Welcome page, click **Start**.
- Step 5** In the **Device Information** field, enter a name and a description for your device. For example, "Personal Devices: Jane's Chromebook Used for School or Shared Devices: Library Chromebook #1 or Classroom 1 Chromebook #1".
- Step 6** Click **Continue**.
- Step 7** Click **Yes** in the **Cisco Network Setup Assistant** dialog box to install the certificate to access the secure network.
- If the Google Administrator configured secure Wi-Fi, the network connection should happen automatically. If it does not, choose the secure SSID from the list of available networks.
- Chromebook users who have already enrolled in the domain, and have the Cisco Network Setup Assistant extension, can update the extension without waiting for the auto update. Manually update the extension by performing the following steps.
- In your Chromebook, open the browser and enter the following URL: **chrome://Extensions**.
  - Check the **Developer Mode** check box.

- c. Click **Update Extensions Now**.
- d. Verify that the Cisco Network Setup Assistant extension version is 2.1.0.35 and higher.

## Google Admin Console - Wi-Fi Network Settings

The Wi-Fi network configuration is used to configure an SSID in a customer network or to match the certificate using certificate attributes (for EAP-TLS). When the certificate is installed in the Chromebook, it is synchronized with the Google admin settings. Connection is established only when one of the defined certificate attributes matches the SSID configuration.

Listed below are the mandatory fields, specific to EAP-TLS, PEAP, and Open network flows, which the Google administrator configures to set up the Wi-Fi network in the Google Admin Console page (**Device Management > Network > Wi-Fi > Add Wi-Fi**) for each Chromebook user.

Field	EAP-TLS	PEAP	Open
Name	Enter the name of the network connection.	Enter the name of the network connection.	Enter the name of the network connection.
Service Set Identifier (SSID)	Enter the SSID (for example, tls_ssid).	Enter the SSID (for example, tls_ssid).	Enter the SSID (for example, tls_ssid).
This SSID Is Not Broadcast	Select the option.	Select the option.	Select the option.
Automatically Connect	Select the option.	Select the option.	Select the option.
Security Type	WPA/WPA2 Enterprise (802.1x)	WPA/WPA2 Enterprise (802.1x)	Open
Extensible Authentication Protocol	EAP-TLS	PEAP	—
Inner Protocol	—	<ul style="list-style-type: none"> <li>• Automatic</li> <li>• MSCHAP v2 (Select the option)</li> <li>• MD5</li> <li>• PAP</li> <li>• MSCHAP</li> <li>• GTC</li> </ul>	—
Outer Identity	—	—	—



Field	EAP-TLS	PEAP	Open
Username	Optional, either set a fixed value or use variables from the user login: <code>\${LOGIN_ID}</code> or <code>\${LOGIN_EMAIL}</code> .	Enter the PEAP credentials to authenticate against ISE (internal ISE user/AD/other ISE identities) and the Password field.	—
Server Certificate Authority	Select the ISE certificate (imported from Device Management > Network > Certificates).	Select the ISE certificate (imported from Device Management > Network > Certificates).	—
Restrict Access to this Wi-Fi Network by Platform	<ul style="list-style-type: none"> <li>• Select Mobile Devices.</li> <li>• Select Chromebooks.</li> </ul>	<ul style="list-style-type: none"> <li>• Select Mobile Devices.</li> <li>• Select Chromebooks.</li> </ul>	—
Client Enrollment URL	Enter a URL to which the Chromebook device browser is redirected for users who are not enrolled. Configure ACLs on the Wireless LAN Controller for redirecting unenrolled users.	—	—

Field	EAP-TLS	PEAP	Open
Issuer Pattern	<p>An attribute in the certificate. Select at least one attribute from either the Issuer Pattern or Subject Pattern that should match installed certificate attributes. Specify certificate attributes that will be matched with the Chromebook device to accept the certificate.</p> <ul style="list-style-type: none"> <li>• Common Name: Refers to the Subject field of the certificate or the wildcard domain in the Subject field of the certificate, which must match the FQDN of the node.</li> <li>• Locality: Refers to the test locality (City) that is associated with the certificate subject.</li> <li>• Organization: Refers to the organization name that is associated with the certificate subject.</li> <li>• Organizational Unit: Refers to the organizational unit name that is associated with the certificate subject.</li> </ul>	—	—

Field	EAP-TLS	PEAP	Open
Subject Pattern	<p>An attribute in the certificate. Select at least one attribute from either the Issuer Pattern or Subject Pattern that should match installed certificate attributes. Specify certificate attributes that will be matched with the Chromebook device to accept the certificate.</p> <ul style="list-style-type: none"> <li>• Common Name: Refers to the Subject field of the certificate or the wildcard domain in the Subject field of the certificate, which must match the FQDN of the node.</li> <li>• Locality: Refers to the test locality (City) that is associated with the certificate subject.</li> <li>• Organization: Refers to the organization name that is associated with the certificate subject.</li> <li>• Organizational Unit: Refers to the organizational unit name that is associated with the certificate subject.</li> </ul>	—	—
Proxy Settings	<ul style="list-style-type: none"> <li>• Direct Internet Connection (Selected)</li> <li>• Manual Proxy Configuration</li> <li>• Automatic Proxy Configuration</li> </ul>	<ul style="list-style-type: none"> <li>• Direct Internet Connection (Selected)</li> <li>• Manual Proxy Configuration</li> <li>• Automatic Proxy Configuration</li> </ul>	—

Field	EAP-TLS	PEAP	Open
Apply Network	By User	By User	—

## Monitor Chromebook Device Activities in Cisco ISE

Cisco ISE provides various reports and logs to view information related to the authentication and authorization of Chromebook devices. You can run these reports either on demand or on regular basis. You can view the authentication method (for example, 802.1x) and authentication protocol (for example, EAP-TLS) in the **Operations > RADIUS > Live Logs** window. You can also identify the number of end points that are classified as Chromebook devices by navigating to the **Work Centers > Network Access > Identities > Endpoints** window.

## Troubleshoot Chromebook Device Onboarding

This section describes problems that you may encounter while onboarding your Chromebook device.

- Error: Unable to install the extension from the webstore—You cannot install the extension from the webstore. It will be automatically installed on your Chromebook device by the network administrator.
- Error: Completed the installation of the certificate, however, unable to connect to the secure network—Verify on the Admin Console that the installed certificate matches defined Issuer/Subject attribute pattern. You can get information about installed certificate from: `chrome://settings/certificates`
- Error: Displays an error message "Obtain Network Certificate", when trying to manually connect to the secure network on the Chromebook—Click Get New Certificate, the browser opens and redirects you to the ISE BYOD flow to install the certificate. However, if you are unable to connect to the secure network, verify on the Admin Console that the installed certificate matches the defined Issuer/Subject attribute pattern.
- Error: Clicked Get New Certificate but is forwarded to the [www.cisco.com](http://www.cisco.com) site—User needs to be connected to the provisioning SSID, in order to be redirected to ISE and commence the certificate installation process. Be sure that the correct access list is defined for this network.
- Error: Displays an error message "Only managed devices can use this extension. Contact helpdesk or network administrator"—Chromebook is a managed device and the extension must be configured as a forced install to gain access to the Chrome OS APIs to install the certificate on the device. Although, the extension can be installed manually by downloading it from the Google web store, an unenrolled Chromebook user cannot install the certificate.

An unenrolled Chromebook device can secure a certificate if the user belongs to the Domain Users group. The extension tracks the domain user on any device. However, the domain user can produce user-based authentication keys for an unenrolled device.

- Error: Unclear of the order in which SSIDs are connected in the Google Admin Console—
  - If several SSIDs (PEAP and EAP-TLS) are configured on the Google Admin Console, after the certificate is installed and the attributes are matched, the Chrome OS automatically connects to the SSID with certificate-based authentication regardless of the order in which the SSIDs are configured.
  - If two EAP-TLS SSIDs match the same attribute, the connection depends on other factors such as signal strength and other network level signals, which cannot be controlled by the user or admin.

- If multiple EAP-TLS certificates are installed on the Chromebook device and all of them match the certificate pattern configured on the Admin Console, the newest certificate will be used for the connection.

## Create AnyConnect Configuration

AnyConnect configuration includes AnyConnect software and its associated configuration files. This configuration can be used in the client provisioning policy that allows users to download and install AnyConnect resources on the clients. If you use both ISE and an ASA to deploy AnyConnect, then the configurations must match on both headends.

To push the ISE posture module when connected to a VPN, Cisco recommends that you install the AnyConnect agent through Cisco Adaptive Security Appliance (ASA), which uses the Cisco's Adaptive Security Device Manager (ASDM) GUI tool. ASA does the installation using the VPN downloader. With the download, the ISE posture profile is pushed via ASA, and the discovery host needed for later provisioning the profile is available before the ISE posture module contacts ISE. Whereas with ISE, the ISE posture module will get the profile only after ISE is discovered, which could result in errors. Therefore, ASA is recommended to push the ISE posture module when connected to a VPN.



---

**Note** When Cisco ISE is integrated with ASA, ensure that the Accounting mode is set to **Single** in ASA. Accounting data is sent to only one accounting server in Single mode.

---

### Before you begin

Before configuring an AnyConnect configuration object, you must:

1. Download the AnyConnect Headend Deployment package and compliance module from [Cisco Software download page](#).
2. Upload these resources to Cisco ISE (see [Add Cisco Provided Client Provisioning Resources from a Local Machine, on page 710](#)).
3. (Optional) Add the customization and localization bundles (see [Add Customer Created Resources for AnyConnect from a Local Machine, on page 710](#)).
4. Configure an AnyConnect posture agent profile (see [Create a Posture Agent Profile, on page 730](#)).

- 
- Step 1** Choose **Policy > Policy Elements > Results > Client Provisioning > Resources**.
- Step 2** Click **Add** to create an AnyConnect configuration.
- Step 3** Choose **AnyConnect Configuration**.
- Step 4** Choose an AnyConnect Package, which you previously uploaded. For example, AnyConnectDesktopWindows xxx.x.xxxxx.x.
- Step 5** Enter the name for the current AnyConnect Configuration. For example, AC Config xxx.x.xxxxx.x.
- Step 6** Choose the compliance module, which you previously uploaded. For example, AnyConnectComplianceModulewindows x.x.xxxx.x

**Step 7** Check one or more AnyConnect module check boxes. For example, choose one or more modules from the following: ISE Posture, VPN, Network Access Manager, Web Security, AMP Enabler, ASA Posture, Start Before Log on (only for Windows OS), and Diagnostic and Reporting Tool.

**Note** Un-checking the VPN module under AnyConnect Module Selection does not disable the VPN tile in the provisioned client. You must configure VPNDisable\_ServiceProfile.xml to disable the VPN tile on AnyConnect GUI. In a system where AnyConnect is installed at the default location, you can find this file under C:\Program Files\Cisco. If AnyConnect is installed at a different location, then the file will be available under <AnyConnect Installed path>\Cisco.

**Step 8** Choose AnyConnect profiles for selected AnyConnect modules. For example, ISE Posture, VPN, NAM, and Web Security.

**Step 9** Choose AnyConnect customization and localization bundles.

**Step 10** Click **Submit**.

## Create a Posture Agent Profile

Use this procedure to create an AnyConnect or a NAC posture agent profile, where you can specify parameters that define the agent behavior for the posture protocol.

**Step 1** Choose **Policy > Policy Elements > Results > Client Provisioning > Resources**.

**Step 2** Click **Add**.

**Step 3** Choose **NAC AnyConnect Agent Posture Profile**.

**Step 4** Under **Posture Agent Profile Settings**, choose **AnyConnect** or **NAC Agent**.

**Step 5** Configure parameters for the following:

- Cisco ISE posture agent behavior
- Client IP Address Changes
- Cisco ISE posture protocol

**Step 6** Click **Submit**.

## Client IP Address Refresh Configuration

The following table describes the fields in the NAC AnyConnect Posture Profile window, which allows you to configure parameters for the client to renew or refresh its IP address after VLAN change. Choose **Policy > Policy Elements > Results > Client Provisioning > Resources > Add > NAC or AnyConnect Posture Profile**.

Field Name	Default Value	Mode (Applies only to Cisco NAC Agent)	Usage Guidelines
<b>VLAN detection interval</b>	0, 5	Merge	<p>This setting is the interval at which the agent check for the VLAN change.</p> <p>For the Windows NAC agent, the default value is 0. By default, the access to authentication VLAN change feature is disabled for Windows. The valid range is 0 to 5 seconds.</p> <p>For the Mac OS X agent, the default value is 5. By default, the access to authentication VLAN change feature is enabled with VlanDetectInteval as 5 seconds for Mac OS X. The valid range is 5 to 900 seconds.</p> <p>0 —Access to Authentication VLAN change feature is disabled.</p> <p>1 to 5—Agent sends an Internet Control Message Protocol (ICMP) or Address Resolution Protocol (ARP) query every 5 seconds.</p> <p>6 to 900—An ICMP or ARP query is sent every x seconds.</p>
<b>Enable VLAN detection without UI (Not applicable for a Mac OS X client)</b>	No	Merge	<p>This setting enables or disables VLAN detection even when the user is not logged in.</p> <p>No—VLAN detect feature is disabled.</p> <p>Yes—VLAN detect feature is enabled.</p>

Field Name	Default Value	Mode (Applies only to Cisco NAC Agent)	Usage Guidelines
<b>Retry detection count</b>	3	Merge	If the Internet Control Message Protocol (ICMP) or Address Resolution Protocol (ARP) polling fails, this setting configures the agent to retry x times before refreshing the client IP address.
<b>Ping or ARP</b>	0 The valid range is 0 to 2.	Merge	This setting specifies the method used for detecting the client IP address change.  0—Poll using ICMP 1—Poll using ARP 2—Poll using ICMP first, then (if ICMP fails) ARP
<b>Maximum timeout for ping</b>	1 The valid range is 1 to 10 seconds.	Merge	Poll using ICMP, and if there is no response within the specified time, then declare an ICMP polling failure.
<b>Enable agent IP refresh</b>	Yes (Default)	Overwrite	This setting specifies whether or not the client machine to renew or refresh its IP address after the switch (or WLC) changes the VLAN for the login session of the client on the respective switch port.
<b>DHCP renew delay</b>	0 The valid range is 0 to 60 seconds.	Overwrite	This setting specifies that the client machine waits before attempting to request for a new IP address from the network DHCP server.
<b>DHCP release delay</b>	0 The valid range is 0 to 60 seconds.	Overwrite	The setting specifies that the client machine waits before releasing its current IP address.





---

**Note** Merge parameter values with existing agent profile settings or overwrite them to appropriately configure clients on Windows and Mac OS X clients for refreshing IP addresses.

---

## Posture Protocol Settings

### Client Login Session Criteria

Cisco ISE looks at various elements when classifying the type of login session through which users access the internal network, including:

- Client machine operating system and version
- Client machine browser type and version
- Group to which the user belongs
- Condition evaluation results (based on applied dictionary attributes)

After Cisco ISE classifies a client machine, it uses client provisioning resource policies to ensure that the client machine is set up with an appropriate agent version, up-to-date compliance modules for antivirus and antispyware vendor support, and correct agent customization packages and profiles, if necessary.

### Agent Download Issues on Client Machine

#### Problem

The client machine browser displays a “no policy matched” error message after user authentication and authorization. This issue applies to user sessions during the client provisioning phase of authentication.

#### Possible Causes

The client provisioning policy is missing required settings.

#### Posture Agent Download Issues

Remember that downloading the posture agent installer requires the following:

- The user must allow the ActiveX installer in the browser session the first time an agent is installed on the client machine. The client provisioning download page prompts for this.
- The client machine must have Internet access.

#### Resolution

- Ensure that a client provisioning policy exists in Cisco ISE. If yes, verify the policy identity group, conditions, and type of agent defined in the policy. Also ensure whether or not there is any agent profile

configured under **Policy > Policy Elements > Results > Client Provisioning > ResourcesAddNAC or AnyConnect Posture Profile**, even a profile with all default values.

- Try re-authenticating the client machine by bouncing the port on the access switch.

## Provision Client Machines with the Cisco NAC Agent MSI Installer

You can place the MSI installer in a directory or a zip version of the same installer on the client machine along with an Agent configuration XML file (named **NACAgentCFG.xml**) containing the appropriate Agent profile information required to coincide with your network.

- 
- Step 1** Download the **nacagentsetup-win.msi** or **nacagentsetup-win.zip** installer file from the Cisco Software Download site from <http://software.cisco.com/download/navigator.html> and navigate to **Security > Access Control and Policy > Cisco Identity Services Engine > Cisco Identity Services Engine Software > Release 1.x**.
- Step 2** Place the **nacagentsetup-win.msi** file in a specific directory on the client machine (for example, `C:\temp\nacagentsetup-win.msi`):
- If you are copying the MSI installer directly over to the client, place the **nacagentsetup-win.msi** file into a directory on the client machine from which you plan to install the Cisco NAC Agent.
  - If you are using the **nacagentsetup-win.zip** installer, extract the contents of the zip file into the directory on the client machine from which you plan to install the Cisco NAC Agent.
- Step 3** Place an Agent configuration XML file in the same directory as the Cisco NAC Agent MSI package.
- If you are not connected to Cisco ISE, you can copy the **NACAgentCFG.xml** file from a client that has already been successfully provisioned. The file is located at `C:\Program Files\Cisco\Cisco NAC Agent\NACAgentCFG.xml`.
- As long as the Agent configuration XML file exists in the same directory as the MSI installer package, the installation process automatically places the Agent configuration XML file in the appropriate Cisco NAC Agent application directory so that the agent can point to the correct Layer 3 network location when it is first launched.
- Step 4** Open a Command prompt on the client machine and enter the following to execute the installation:
- ```
msiexec.exe /i NACAgentSetup-win.msi /qn /l*v c:\temp\agent-install.log
```
- (The `/qn` qualifier installs the Cisco NAC Agent completely silently. The `/l*v` logs the installation session in verbose mode.)
- To uninstall the NAC Agent, you can execute the following command:
- ```
msiexec /x NACAgentSetup-win-<version>.msi /qn
```
- Installing a new version of the Agent using MSI will uninstall the old version and install the new version using the above commands.
- Step 5** If you are using Altiris/SMS to distribute the MSI installer, place the Agent customization files in a sub-directory named “brand” in the directory “%TEMP%/CCAA”. When the Cisco NAC Agent is installed in the client, the customization is applied to the Agent. To remove the customization, send a plain MSI without the customization files.
-

# Cisco ISE Posture Agents

Posture agents are applications that reside on client machines logging into the Cisco ISE network. Agents can be persistent (like the AnyConnect, Cisco NAC Agent for Windows and Mac OS X) and remain on the client machine after installation, even when the client is not logged into the network. Agents can also be temporal (like the Cisco NAC Web Agent, ), removing themselves from the client machine after the login session has terminated. In either case, the Agent helps the user to log in to the network, receive the appropriate access profile, and even perform posture assessment on the client machine to ensure it complies with network security guidelines before accessing the core of the network.



---

**Note** Currently Cisco NAC Agent and Cisco NAC Web Agent support Client Provisioning Portal and Native Supplicant Provisioning. Cisco NAC Web Agent supports Central Web Authentication flow (CWA), but Cisco NAC Agent does not support CWA.

---

## Posture Agent Discovery Request and Cisco ISE Response

Cisco ISE supports coexistence of AnyConnect and legacy Cisco ISE NAC agents on Windows and Mac OS x clients. Agents start the posture discovery probe only when there is any change in the network on the clients. Cisco ISE responds to the client's posture discovery probe based on the client provisioning policy and the corresponding agent will get the discovery response, which results in only one agent being active.

Based on the client provisioning policy, Cisco ISE differs in responding to the agents posture discovery probe as below:

- If the endpoint is configured to use the legacy agent (Cisco ISE NAC agent for Windows and Mac OS x), the agent receives the discovery response with a string "X-perfigo-CAS=FQDN" in the existing format. AnyConnect stops discovery, if the discovery response is received for the legacy agent.
- If the endpoint is configured to use AnyConnect, Cisco ISE responds in a different format. This will be the Cisco ISE Policy Service node FQDN and the AnyConnect Configuration URL, AnyConnect package location and version based on the client provisioning policy. The legacy agent stops discovery, if the response is received for AnyConnect.



---

**Note** MAC OSX devices do not send requests to default gateway. These devices use only the following two probes:

- discovery host
- enroll.cisco.com

Ensure that you have configured correct DNS on MAC OSX devices to resolve enroll.cisco.com.

---

## Web Agent Posture Discovery Request and Cisco ISE Response

The Web agent does not do discovery probe. If an endpoint is configured to use the Web agent, Cisco ISE responds using the format, X-ISE-PDP-WEBAGENT=FQDN". The webagent discovery response invokes the Cisco NAC Agent on the client, if the client provisioning policy is configured to use the Web agent.

### Agent Displays “Temporary Access”

#### Problem

A client machine is granted “Temporary Access” to the network following login and authentication, but administrator and users expect full network access.

#### Possible Causes

This issue is applicable to any client machine login session using an agent to connect.

If the Cisco Agent is running on the client and:

- The interface on the client machine goes down
- The session is terminated

#### Resolution

The user must try to verify network connectivity and then try to log in again (and pass through posture assessment, as well) to attempt to reestablish the connection.

### Agent Fails to Initiate Posture Assessment

#### Problem

The user is presented with a “Clean access server not available” message. This issue applies to any agent authentication session from Cisco ISE.

#### Possible Cause

This error could mean that either the session has terminated or Cisco ISE is no longer reachable on the network.

#### Resolution

- The user can try to log into the network again.
- The user can try to ping the default gateway or the RADIUS server IP address or FQDN supplied by the network administrator.
- The administrator can check network access attributes for the user (like the assigned VLAN, ACLs, routing, execute the **nslookup** command on the client, client machine DNS connection, and so on).

# Cisco AnyConnect Secure Mobility

Cisco ISE uses an integrated module in Cisco AnyConnect for Cisco ISE posture requirements. Cisco AnyConnect is the posture agent that coexists with Cisco ISE NAC Agent on the same endpoint. Only one of the agents is active at a time.



---

**Note** AnyConnect does not support CWA flow. You can't provision AnyConnect from the Guest portal using the **Require guest device compliance** field in the **Work CentersGuest Access > Portals & Components > Guest Portals > Create, Edit, or Duplicate > Portal Behavior and Flow Settings > Guest Device Compliance Settings** window. Instead, provision AnyConnect on the Client Provisioning portal. This method results in redirection as configured in authorization permissions.

---

When you integrate Cisco ISE with the Cisco AnyConnect agent, Cisco ISE:

- Serves as a staging server to deploy Cisco AnyConnect Version 4.0 and future releases
- Interacts with the AnyConnect posture component for Cisco ISE posture requirements
- Supports deployment of Cisco AnyConnect profiles, customization and language packages, and OPSWAT library updates for Windows and Mac OS X operating systems
- Supports Cisco AnyConnect and legacy agents at the same time



---

**Note** When switching network mediums, you must change the default gateway so the posture module can detect the changed network and reassess the client.

---

## Cisco NAC Agent XML File Installation Directories

In a system where the Cisco NAC Agent installed at the default location, you can find the following .xml files in the following directories:

- The nac\_login.xml file is available in the “C:\Program Files\Cisco\Cisco NAC Agent\UI\nac\_divs\login” directory.
- In the nacStrings\_xx.xml file, the “xx” indicates the locale. You can find a complete list of the files in the “C:\Program Files\Cisco\Cisco NAC Agent\UI\cues\_utility” directory.

If the agent is installed at a different location, then the files would be available at “<Agent Installed path>\Cisco\Cisco NAC Agent\UI\nac\_divs\login” and “<Agent Installed path>\Cisco\Cisco NAC Agent\cues\_utility”.

## Cisco NAC Agent for Windows Clients

The Cisco NAC Agent provides the posture assessment and remediation for client machines.

Users can download and install the Cisco NAC Agent (read-only client software), which can check the host registry, processes, applications, and services. The Cisco NAC Agent can be used to perform Windows updates or antivirus and antispyware definition updates, launch qualified remediation programs, distribute files uploaded to the Cisco ISE server, distribute website links to web sites for users to download files to fix their system, or simply distribute information and instructions.

Cisco strongly recommends that you ensure that the latest Windows hotfixes and patches are installed on Windows XP clients so that the Cisco NAC Agent can establish a secure and encrypted communication with Cisco ISE (via SSL over TCP).

## Uninstall the Cisco NAC Agent from Windows 7 and Earlier Clients

The Cisco NAC Agent installs to **C:\Program Files\Cisco\Cisco NAC Agent\** on the Windows client.

You can uninstall the agent in the following ways:

- By double-clicking the **Uninstall Cisco NAC Agent** desktop icon.
- By going to **Start Menu > Programs > Cisco Systems > Cisco Clean Access > Uninstall Cisco NAC Agent**
- By going to **Start Menu > Control Panel > Add or Remove Programs > Cisco NAC Agent** and uninstall the Cisco NAC Agent.

## Uninstall the Cisco NAC Agent in a Windows 8 Client

You can uninstall Cisco NAC Agent in a Windows 8 client in Metro mode.

- 
- Step 1** Switch to Metro Mode.
- Step 2** Right-Click **Cisco NAC Agent** tile.
- Step 3** Select **Un-Install** from the options available at the bottom of the screen.
- Step 4** The system automatically switches to Desktop mode and opens **Add/Remove** control panel.
- Step 5** In the **Add/Remove** control panel, perform one of the following:
- a) Double Click **Cisco NAC Agent** and click **Uninstall**.
  - b) Select **Cisco NAC Agent** and click **Uninstall**.
  - c) Right Click **Cisco NAC Agent** and select **Uninstall**.
- 

## Windows 8 Metro and Metro App Support —Toast Notifications

The Enable Toast Notification option is available on the Cisco NAC Agent Tray Icon that can send relevant notifications to users on Windows 8 clients .

In Cisco NAC Agent scenarios where the user does not get network access, like "Remediation Failed" or "Network Access expired", the Agent displays the following toast notification:Network not available, Click "OK" to continue.

To get more details, you can select the toast and you will be redirected to Desktop mode and the Cisco NAC agent dialog is displayed.

Toast Notification is displayed for all positive recommended actions that the user needs to perform to gain network access. The following are some examples:

- For Network Acceptance policy, toast will be displayed as: "Click Accept to gain network access"
- For Agent/Compliance Module Upgrade, toast will be displayed as: "Click OK to Upgrade/Update"
- In the "user logged out" event, when "Auto Close" option for Logoff is not enabled in Clean Access Manager (CAM), toast notification is provided. This toast enables the users to know that they have been logged out and that they need to login again to get network access.

## Cisco NAC Agent for Macintosh Clients

The Cisco NAC OS X Agent provides the posture assessment and remediation for Macintosh client machines.

Users can download and install the Cisco NAC OS X Agent (read-only client software), which can check antivirus and antispymware definition updates.

After users log in to the Cisco NAC OS X Agent, the agent gets the requirements that are configured for the user role and the operating system from the Cisco ISE server, checks for required packages and sends a report back to the Cisco ISE server. If requirements are met on the client, the user is allowed network access. If requirements are not met, the agent presents a dialog to the user for each requirement that is not satisfied. The dialog provides the user with instructions and the action to take for the client machine to meet the requirement. Alternatively, if the specified requirements are not met, users can choose to accept restricted network access while the user tries to remediate the client system.

## Uninstall the Cisco NAC Agent from Macintosh Clients

You can uninstall the Cisco NAC Agent for Mac OS X clients by running the uninstall script as follows:

- 
- Step 1** Open the navigator pane and navigate to *<local drive ID>* > **Applications**.
  - Step 2** Highlight and right-click the **CCAAgent** icon to bring up the selection menu.
  - Step 3** Choose **Show Package Contents** and double-click **NacUninstall** to uninstall the Cisco NAC Agent on Mac OS X.
- 

## Cisco Web Agent

The Cisco Web Agent provides temporal posture assessment for client machines.

Users can launch the Cisco Web Agent executable, which installs the Web Agent files in a temporary directory on the client machine via ActiveX control or Java applet.

After users log in to the Cisco Web Agent, the Web Agent gets the requirements that are configured for the user role and the operating system from the Cisco ISE server, checks the host registry, processes, applications, and services for required packages and sends a report back to the Cisco ISE server. If requirements are met on the client machine, the user is allowed network access. If requirements are not met, the Web Agent presents a dialog to the user for each requirement that is not satisfied. The dialog provides the user with instructions and the action to take for the client machine to meet the requirement. Alternatively, if the specified requirements

are not met, users can choose to accept the restricted network access while they try to remediate the client system so that it meets requirements for the user login role.



**Note** ActiveX is supported only on the 32-bit versions of Internet Explorer. You cannot install ActiveX on a Firefox web browser or on a 64-bit version of Internet Explorer.

## Cisco NAC Agent Logs

In the Cisco NAC Agent for Windows, right-click the Agent Tray Icon and then click **Log Packager** to run the support package and collect the agent logs.

In the Cisco NAC Agent for Cisco NAC OS X, in the Tools menu, right-click the Agent icon and click the **Collect Support Logs** option to collect the agent logs and support information. The collected information is available as a zip file. The user can save the file by choosing the file location and filename. By default the file is saved on the desktop with the filename as *CiscoSupportReport.zip*.

If the agent crashes or hangs, you can run the **CCAAgentLogPackager.app** to collect the logs. This file is available at /Applications/CCAAgent.app. You can right-click **CCAAgent.app**, select **Show Package Contents** and double-click **CCAAgentLogPackager** to collect the support information.

## Create an Agent Customization File for the Cisco NAC Agent

An agent customization file allows you to customize the logo, fields, and message text contained in a Cisco NAC Agent screen dialog to suit your specific Windows client network access requirements.

You can create a customization package as a .zip file that contains an XML descriptor file and another .zip file with the contents comprising the customized options.

- 
- Step 1** Assemble the files required to comprise your Agent screen customization package:
- Customized nac\_login.xml file
  - Customized corporate/company logo as a .gif file
  - One or more customized nacStrings\_xx.xml files
  - Customized updateFeed.xml descriptor file
- Step 2** Create a zip file called “brand-win.zip” that contains the assembled files. For example, in a Linux or Unix environment, execute the following: **zip -r brand-win.zip nac\_login.xml nac\_logo.gif nacStrings\_en.xml nacStrings\_cy.xml nacStrings\_el.xml**
- Step 3** Create a “custom.zip” file that contains an appropriate updateFeed.xml descriptor file and the .zip file created above. For example, in a Linux or Unix environment, execute the following: **zip -r custom.zip updateFeed.xml brand-win.zip**
- Step 4** Save the resulting “custom.zip” file to a location on a local machine that you can access when uploading the file to Cisco ISE.
-



## Custom nac\_login.xml File Template

The nac\_login.xml file is one of the files that is required in your Agent screen customization package, which allows you to customize the logo, fields, and message text contained in a Cisco NAC Agent dialog, like the Properties window, to suit your specific Windows client network access requirements.

Use the following template to construct an appropriate “nac\_login.xml” file to customize the logo, fields, and message text contained in a Cisco NAC Agent screen.

The following example shows a customized file.

```
<tr class="nacLoginMiddleSectionContainerInput">
<td colspan="2">
<fieldset width="100%" id="nacLoginCustomAlert"
style="display:block" class="nacLoginAlertBox">
<table width="100%">
<tr>
<td id="nacLoginCustomAlert.img" valign="top" width="32px">

</td>
<td id="nacLoginCustomAlert.content" class="nacLoginAlertText">
<cues:localize key="login.customalert"/>
</td>
</tr>
</table>
</fieldset>
</td>
</tr>
<tr id="nacLoginRememberMe" style="visibility:hidden">
<td>
<cues:localize key="cd.nbsp"/>
</td>
<td class="cuesLoginField">
<nobr>
<input type="checkbox" alt="" title="" name="rememberme"
id="rememberme" checked="true"/>
<cues:localize key="login.remember_me"/>
</nobr>
</td>
</tr>
```

## Custom nacStrings\_xx.xml File Template

This is one of the files that is required in your Agent screen customization package, allows you to customize the logo, fields, and message text contained in a Cisco NAC Agent dialog, like the Properties screen, to suit your specific Windows client network access requirements.

Use the following template to construct a one or more nacStrings\_xx.xml files, where xx is a two-character identifier for the specific language.

The following example shows a customized nacStrings\_xx.xml file.

```
<cueslookup:appstrings xmlns:cueslookup="http://www.cisco.com/cues/lookup">
<cueslookup:name key="nac.brand.legal_name">Cisco Systems, Inc.</cueslookup:name>
<cueslookup:name key="nac.brand.full_name">Cisco Systems</cueslookup:name>
<cueslookup:name key="nac.brand.short_name">Cisco</cueslookup:name>
<cueslookup:name key="nac.brand.abbreviation">Cisco</cueslookup:name>
<cueslookup:name key="nac.copyright">Copyright </cueslookup:name>
<cueslookup:name key="nac.copyright.period">2009-2013</cueslookup:name>
```

```

<cueslookup:name key="nac.copyright.arr">All Rights Reserved</cueslookup:name>
<cueslookup:name key="updateagent.rqst">NAC Agent %1 is available.%br% Do you want to install
this update now?</cueslookup:name>
<cueslookup:name key="updateagent.rqst.retry">Unable to update NAC Agent. Please try
again.</cueslookup:name>
<cueslookup:name key="downloadagent.report">Downloading the update of NAC
Agent.</cueslookup:name>
<cueslookup:name key="downloadagent.packagename.label">Package Name</cueslookup:name>
<cueslookup:name key="downloadagent.completed.label">Completed</cueslookup:name>
<cueslookup:name key="downloadagent.completed.value">%1 of %2 bytes</cueslookup:name>
<cueslookup:name key="downloadagent.speed.label">Speed</cueslookup:name>
<cueslookup:name key="downloadagent.speed.value">%1 bytes/sec</cueslookup:name>
<cueslookup:name key="updateopswat.rqst">NAC Agent Posture component version %1 is
available.%br% Do you want to install this update now?</cueslookup:name>
<cueslookup:name key="updateopswat.rqst.retry">Unable to update NAC Agent Posture
Please try again.</cueslookup:name>
<cueslookup:name key="downloadopswat.report">Downloading the update of NAC Agnet Posture
component.</cueslookup:name>
<cueslookup:name key="login.productname">Education First Compliance Check</cueslookup:name>

<cueslookup:name key="login.version">Version</cueslookup:name>
<cueslookup:name key="login.opswatversion">Posture Component Version</cueslookup:name>
<cueslookup:name key="login.username">Enter your username</cueslookup:name>
<cueslookup:name key="login.password">Enter your PIN</cueslookup:name>
<cueslookup:name key="login.remember_me">Remember Me</cueslookup:name>
<cueslookup:name key="login.server">Server</cueslookup:name>
<cueslookup:name key="login.customalert">Custom EF package version 2.1.1.1 with EF
Logo</cueslookup:name>
<cueslookup:name key="login.Too many users using this account">This account is already
active on another device</cueslookup:name>
<cueslookup:name key="login.differentuser">Login as Different User</cueslookup:name>
<cueslookup:name key="login.removeoldest">Remove Oldest Login Session</cueslookup:name>
<cueslookup:name key="menu_devtools">Dev Tools</cueslookup:name>
<cueslookup:name key="c.sso.ad">Performing Windows Domain automatic login for
NAC</cueslookup:name>
<cueslookup:name key="c.sso.generic">Unknown authentication type</cueslookup:name>
<cueslookup:name key="c.sso.macauth">Performing device filter automatic login for
NAC</cueslookup:name>
<cueslookup:name key="c.sso.vpn">Performing automatic login into NAC environment for remote
user</cueslookup:name>
<cueslookup:name key="c.title.status.authenticating">Authenticating User</cueslookup:name>

<cueslookup:name key="c.title.status.answeringchallenge">Sending Response</cueslookup:name>

<cueslookup:name key="c.title.status.checking">Checking Requirements</cueslookup:name>
<cueslookup:name key="c.title.status.checkcomplete">System Check Complete</cueslookup:name>

<cueslookup:name key="c.title.status.loggedin">NAC Process Completed</cueslookup:name>
<cueslookup:name key="c.title.status.netaccess.none">NAC Process Completed</cueslookup:name>

<cueslookup:name key="c.title.status.netpolicy">Network Usage Policy</cueslookup:name>
<cueslookup:name key="c.title.status.properties">Agent Properties &
Information</cueslookup:name>
<cueslookup:name key="c.title.status.remediating">Remediating System</cueslookup:name>
<cueslookup:name key="c.title.status.session.expired">Session has Expired</cueslookup:name>

<cueslookup:name key="c.title.status.update.available">Update Agent</cueslookup:name>
<cueslookup:name key="c.title.status.update.downloading">Downloading Agent</cueslookup:name>

<cueslookup:name key="c.title.status.update.opswat.available">Update Posture
Component</cueslookup:name>
<cueslookup:name key="c.title.status.update.opswat.downloading">Downloading Posture
Component</cueslookup:name>
<cueslookup:name key="scanning">Checking</cueslookup:name>

```

```

<!-- <cuelookup:name key="scanningitemcomplete">Finished Checking</cuelookup:name> -->
<cuelookup:name key="ph.about">About</cuelookup:name>
<cuelookup:name key="ph.cancel">Cancel</cuelookup:name>
<!-- <cuelookup:name key="ph.details">Details</cuelookup:name> -->
<cuelookup:name key="ph.logout">Logout</cuelookup:name>
<cuelookup:name key="title_remediating">Remediating System</cuelookup:name>
<cuelookup:name key="title_check_complete">System Check Complete</cuelookup:name>
<cuelookup:name key="title_full_access_granted">Logged In</cuelookup:name>
<cuelookup:name key="title_access_denied">Network Access Denied</cuelookup:name>
<cuelookup:name key="tempNetAccess">Temporary Network Access</cuelookup:name>
<cuelookup:name key="announcePleaseBePatient">Please be patient while your system is checked
 against the network security policy
</cuelookup:name>
<cuelookup:name key="bbtn.accept">Accept</cuelookup:name>
<cuelookup:name key="bbtn.apply">Apply</cuelookup:name>
<cuelookup:name key="bbtn.cancel">Cancel</cuelookup:name>
<cuelookup:name key="bbtn.continue">Update Later</cuelookup:name>
<cuelookup:name key="bbtn.close">Close</cuelookup:name>
<cuelookup:name key="bbtn.detailshide">Hide Compliance</cuelookup:name>
<cuelookup:name key="bbtn.detailsshow">Show Compliance</cuelookup:name>
<cuelookup:name key="bbtn.download">Download</cuelookup:name>
<cuelookup:name key="bbtn.guestAccess">Guest Access</cuelookup:name>
<cuelookup:name key="bbtn.go2link">Go To Link</cuelookup:name>
<cuelookup:name key="bbtn.launch">Launch</cuelookup:name>
<cuelookup:name key="bbtn.login">Log In</cuelookup:name>
<cuelookup:name key="bbtn.next">Re-Scan</cuelookup:name>
<cuelookup:name key="bbtn.ok">OK</cuelookup:name>
<cuelookup:name key="bbtn.propertieshide">Hide Properties</cuelookup:name>
<cuelookup:name key="bbtn.reject">Reject</cuelookup:name>
<cuelookup:name key="bbtn.remediate">Repair</cuelookup:name>
<cuelookup:name key="bbtn.rescan">Rescan</cuelookup:name>
<cuelookup:name key="bbtn.reset">Reset</cuelookup:name>
<cuelookup:name key="bbtn.restrictedNet">Get Restricted NET access This one comes down
 from the network</cuelookup:name>
<cuelookup:name key="bbtn.saverereport">Save Report</cuelookup:name>
<cuelookup:name key="bbtn.skip">Skip</cuelookup:name>
<cuelookup:name key="bbtn.skipao">Skip All Optional</cuelookup:name>
<cuelookup:name key="bbtn.submit">Submit</cuelookup:name>
<cuelookup:name key="bbtn.update">Update</cuelookup:name>
<cuelookup:name key="cd.days">
 days
</cuelookup:name>
<cuelookup:name key="cd.nbsp">

</cuelookup:name>
<cuelookup:name key="cd.tempNetAccess.counting">
 There is approximately %1 left until your temporary network access expires
</cuelookup:name>
<cuelookup:name key="cd.tempNetAccess.expired">
 Your Temporary Network Access has Expired!
</cuelookup:name>
<cuelookup:name key="cd.tempNetAccessShort.counting">
 %1 left
</cuelookup:name>
<cuelookup:name key="cd.tempNetAccessShort.expired">
 Expired!
</cuelookup:name>
<cuelookup:name key="cd.window.counting">
 This window will close in %1 secs
</cuelookup:name>
<cuelookup:name key="dp.status.fullNetAccess">
 Full Network Access
</cuelookup:name>
<cuelookup:name key="dp.status.fullNetAccess.verbose">

```

```

Your device conforms with all the security policies for this protected
network
</cueslookup:name>
<cueslookup:name key="dp.status.fullNetAccessWarn.verbose">
Only optional requirements are failing.
It is recommended that you update your system at
your earliest convenience.
</cueslookup:name>
<cueslookup:name key="dp.status.iprefresh.progress.verbose">
Refreshing IP address. Please Wait...
</cueslookup:name>
<cueslookup:name key="dp.status.iprefresh.complete.verbose">
Refreshing IP address succeeded.
</cueslookup:name>
<cueslookup:name key="dp.status.vlanchange.progress.verbose">
Connecting to protected Network. Please Wait...
</cueslookup:name>
<cueslookup:name key="dp.status.guestNetAccess">
Guest Network Access
</cueslookup:name>
<cueslookup:name key="dp.status.noNetAccess">
Network Access Denied
</cueslookup:name>
<cueslookup:name key="dp.status.noNetAccess.verbose">
There is at least one mandatory requirement failing.
You are required to update your system before
you can access the network.
</cueslookup:name>
<cueslookup:name key="dp.status.rejectNetPolicy.verbose">
Network Usage Terms and Conditions are rejected. You will not be
allowed to access the network.
</cueslookup:name>
<cueslookup:name key="dp.status.RestrictedNetAccess">
Restricted Network Access granted.
</cueslookup:name>
<cueslookup:name key="dp.status.RestrictedNetAccess.verbose">
You have been granted restricted network access because your device
did not conform with all the security policies for this protected
network and you have opted to defer updating your system. It is recommended
that you update your system at your earliest convenience.
</cueslookup:name>
<cueslookup:name key="dp.status.temporaryNetAccess">
Temporary Network Access
</cueslookup:name>
<cueslookup:name key="dp.status.temporaryNetAccess.bepatient.verbose">
Please be patient while your system is checked against the network security policy.
</cueslookup:name>
<cueslookup:name key="dp.status.pra.mandatoryfailure">
Performing Re-assessment
</cueslookup:name>
<cueslookup:name key="dp.status.pra.mandatoryfailure.verbose">
There is at least one mandatory requirement failing.
You are required to update your system otherwise
your network access will be restricted.
</cueslookup:name>
<cueslookup:name key="dp.status.pra.optionalfailure">
Performing Re-assessment
</cueslookup:name>
<cueslookup:name key="dp.status.pra.optionalfailure.verbose">
Only optional requirements are failing.
It is recommended that you update your system at
your earliest convenience.
</cueslookup:name>
<cueslookup:name key="dp.status.SessionTimeout">

```

```
Logged out
</cueslookup:name>
<cueslookup:name key="dp.status.SessionTimeout.verbose">
Temporary Access to the network has expired.
</cueslookup:name>
<cueslookup:name key="dp.status.Unauthenticated">
Logged out
</cueslookup:name>
<cueslookup:name key="dp.status.Unauthenticated.verbose">

</cueslookup:name>
<cueslookup:name key="ia.status.checkcomplete">
Finished Checking Requirements
</cueslookup:name>
<cueslookup:name key="ia.status.check.inprogress">
Please be patient while we determine if your system is compliant with the security policy
</cueslookup:name>
<cueslookup:name key="ia.status.check.inprogress.01">
Checking %1 out of %2
</cueslookup:name>
<cueslookup:name key="ia.status.netpolicy">
Access to the network requires that you view and accept the following
Network Usage Policy
</cueslookup:name>
<cueslookup:name key="ia.status.netpolicylinktxt">
Network Usage Policy Terms and Conditions
</cueslookup:name>
<cueslookup:name key="ia.status.remediate.inprogress">
Remediating
</cueslookup:name>
<cueslookup:name key="ia.status.remediate.start">
Please Remediate
</cueslookup:name>
<cueslookup:name key="ia.status.remediate.checkinprogress">
Checking for compliance with Requirement
</cueslookup:name>
<cueslookup:name key="ia.table.name">
Name
</cueslookup:name>
<cueslookup:name key="ia.table.location">
Location
</cueslookup:name>
<cueslookup:name key="ia.table.software">
Software
</cueslookup:name>
<cueslookup:name key="ia.table.software.programs">
program(s)
</cueslookup:name>
<cueslookup:name key="ia.table.update">
Update
</cueslookup:name>
<cueslookup:name key="ia.table.locationcode.nochange">
Do not change current setting
</cueslookup:name>
<cueslookup:name key="ia.table.locationcode.notifybeforedownload">
Notify before download
</cueslookup:name>
<cueslookup:name key="ia.table.locationcode.notifybeforeinstall">
Notify before install
</cueslookup:name>
<cueslookup:name key="ia.table.locationcode.scheduledinstallation">
Download and installation
</cueslookup:name>
<cueslookup:name key="ia.table.locationcode.forcenotifybeforedownload">
```

```

Change to notify before download
</cueslookup:name>
<cueslookup:name key="ia.table.locationcode.forcenotifybeforeinstall">
Change to notify before installation
</cueslookup:name>
<cueslookup:name key="ia.table.locationcode.forcescheduledinstall">
Change to download and installation
</cueslookup:name>
<cueslookup:name key="ia.table.description">
Description
</cueslookup:name>
<cueslookup:name key="scs.table.title">
Security Compliance Summary
</cueslookup:name>
<cueslookup:name key="scs.table.header1.scan_rslt">
Scan Result
</cueslookup:name>
<cueslookup:name key="scs.table.header1.pack_name">
Requirement Name
</cueslookup:name>
<cueslookup:name key="scs.table.header1.pack_details">
Requirement Description - Remediation Suggestion
</cueslookup:name>
<cueslookup:name key="scs.table.data.mandatory">
Mandatory
</cueslookup:name>
<cueslookup:name key="scs.table.data.optional">
Optional
</cueslookup:name>
<cueslookup:name key="scs.table.data.pass">
Passed
</cueslookup:name>
<cueslookup:name key="ia.rem_inst_optional_download">
Please download and install the optional software before accessing the network
</cueslookup:name>
<cueslookup:name key="ia.rem_inst_mandatory_download">
Please download and install the required software before accessing the network
</cueslookup:name>
<cueslookup:name key="ia.rem_inst_optional_launch">
Please launch the optional remediation program(s) before accessing the network
</cueslookup:name>
<cueslookup:name key="ia.rem_inst_mandatory_launch">
Please launch the required remediation program(s) before accessing the network
</cueslookup:name>
<cueslookup:name key="ia.rem_inst_optional_opswat_av">
Please update the virus definition file of the specified antivirus software before accessing
the network (optional)
</cueslookup:name>
<cueslookup:name key="ia.rem_inst_mandatory_opswat_av">
Please update the virus definition file of the specified antivirus software before accessing
the network (required)
</cueslookup:name>
<cueslookup:name key="ia.rem_inst_optional_opswat_as">
Please update the spyware definition file of the specified anti-spyware software before
accessing the network (optional)
</cueslookup:name>
<cueslookup:name key="ia.rem_inst_mandatory_opswat_as">
Please update the spyware definition file of the specified anti-spyware software before
accessing the network (required)
</cueslookup:name>
<cueslookup:name key="ia.rem_inst_optional_win_update">
Please download and install the optional windows updates before accessing the network
</cueslookup:name>
<cueslookup:name key="ia.rem_inst_mandatory_win_update">

```

```

Please download and install the required windows updates before accessing the network
</cueslookup:name>
<cueslookup:name key="ia.rem_inst_auto_launch_prog">
Launching Remediation Program(s)...
</cueslookup:name>
<cueslookup:name key="ia.rem_inst_auto_launch_url">
Launching Remediation URL...
</cueslookup:name>
<cueslookup:name key="ia.rem_inst_auto_opswat_av">
Updating Virus Definition...
</cueslookup:name>
<cueslookup:name key="ia.rem_inst_auto_opswat_as">
Updating Spyware Definition...
</cueslookup:name>
<cueslookup:name key="ia.rem_inst_auto_win_update">
Launching Windows auto Update(s)...
</cueslookup:name>
<cueslookup:name key="ia.rem_launch_downloaded_file">
Downloaded at %1. %br% Please open this folder & double-click executable file to
install the required software.
</cueslookup:name>
<cueslookup:name key="discoveryhost.label">
Discovery Host
</cueslookup:name>
<cueslookup:name key="properties.table.title">
List of Antivirus & Anti-Spyware Products Detected by the Agent
</cueslookup:name>
<cueslookup:name key="properties.table.header1.index">
No.
</cueslookup:name>
<cueslookup:name key="properties.table.header1.description">
Description
</cueslookup:name>
<cueslookup:name key="properties.table.header1.value">
Value
</cueslookup:name>
<cueslookup:name key="properties.table.data.product_type">
Product Type
</cueslookup:name>
<cueslookup:name key="properties.table.data.product_name">
Product Name
</cueslookup:name>
<cueslookup:name key="properties.table.data.product_version">
Product Version
</cueslookup:name>
<cueslookup:name key="properties.table.data.def_version">
Definition Version
</cueslookup:name>
<cueslookup:name key="properties.table.data.def_date">
Definition Date
</cueslookup:name>
<cueslookup:name key="reboot.mandatory.001">
Mandatory System Reboot Required
</cueslookup:name>
<cueslookup:name key="reboot.optional.001">
You need to reboot your system in order for the changes to take effect.
</cueslookup:name>
<cueslookup:name key="rem.error.001">
Unable to remediate particular requirement
</cueslookup:name>
<cueslookup:name key="rem.error.av_access_denied">
The remediation you are attempting is reporting an access denied error. This is usually due
to a privilege issue. Please contact your system administrator.
</cueslookup:name>

```

```
<cueslookup:name key="rem.error.av_buffer_too_small">
The remediation you are attempting has failed with an internal error. Please contact your
system administrator.
</cueslookup:name>
<cueslookup:name key="rem.error.av_elevation_required">
The remediation you are attempting requires elevation. Please contact your system
administrator.
</cueslookup:name>
<cueslookup:name key="rem.error.av_failed">
The remediation you are attempting had a failure. If the problem persists contact your
system administrator.
</cueslookup:name>
<cueslookup:name key="rem.error.av_internal_error">
The remediation you are attempting has reported an internal error. If this problem persists
please contact your system administrator.
</cueslookup:name>
<cueslookup:name key="rem.error.av_not_implemented">
The remediation you are attempting is not implemented for this product. Please contact your
system administrator.
</cueslookup:name>
<cueslookup:name key="rem.error.av_not_supported">
The remediation you are attempting is not supported for this product. Please contact your
system administrator.
</cueslookup:name>
<cueslookup:name key="rem.error.av_update_fail">
The AV/AS update has failed. Please try again and if this message continues to display
contact your system administrator.
</cueslookup:name>
<cueslookup:name key="rem.error.av_update_failed_due_to_network">
The AV/AS update failed due to a networking issue. Please try again and if this message
continues to display contact your system administrator.
</cueslookup:name>
<cueslookup:name key="rem.error.av_timeout">
The remediation you are attempting has timed out waiting for the operation to finish. If
this continues please contact your system administrator.
</cueslookup:name>
<cueslookup:name key="rem.error.file_dist_size_error">
The size of the downloaded file does not match the package! Please discard downloaded file
and check with your administrator.
</cueslookup:name>
<cueslookup:name key="rem.error.file_is_not_signed">
The file that has been requested was not digitally signed. Please try again and if this
message continues to display contact your system administrator.
</cueslookup:name>
<cueslookup:name key="rem.error.file_save_location_error">
The location for the file to be saved to can not be written. Please choose a different
location.
</cueslookup:name>
<cueslookup:name key="rem.error.http_file_not_found">
The requested file is not found. Please try again and if this problem persists, contact
your system administrator.
</cueslookup:name>
<cueslookup:name key="rem.error.launch_file_not_found">
The file that has been requested could not be launched either because it could not be found
or there was a problem launching it. Please contact your system administrator.
</cueslookup:name>
<cueslookup:name key="rem.error.malformed_URL">
The file that is trying to be downloaded has an incorrect URL. Please contact your system
administrator.
</cueslookup:name>
<cueslookup:name key="rem.error.network_error">
There has been a network error, please try the remediation again. If this message continues
to be seen contact your system administrator.
</cueslookup:name>
```



```
<cueslookup:name key="rem.error.update_fail_for_non_admin">
The remediation you are trying to do can not be accomplished at your user level. Please
contact your system administrator.
</cueslookup:name>
<cueslookup:name key="rem.error.wsus_search_failure">
The WSUS search failed. This is probably due to a network issue. Please try again and if
this message continues to display contact your system administrator.
</cueslookup:name>
<cueslookup:name key="server.error.generic">
Agent encountered problems logging user
</cueslookup:name>
<cueslookup:name key="server.error.255">
Network Error: NAC Server could not establish a secure connection to NAC Manager.
This could be due to one or more of the following reasons:
1) NAC Manager certificate has expired or
2) NAC Manager certificate cannot be trusted or
3) NAC Manager cannot be reached or
4) NAC Manager is not responding
Please report this to your network administrator.
</cueslookup:name>
<cueslookup:name key="server.error.5000">
Invalid provider name
</cueslookup:name>
<cueslookup:name key="server.error.5001">
Failed to add user to online list
</cueslookup:name>
<cueslookup:name key="server.error.5002">
Server communication error
</cueslookup:name>
<cueslookup:name key="server.error.5003">
Invalid username or password
</cueslookup:name>
<cueslookup:name key="server.error.5004">
Unknown user
</cueslookup:name>
<cueslookup:name key="server.error.5005">
Account expired
</cueslookup:name>
<cueslookup:name key="server.error.5006">
Account currently disabled
</cueslookup:name>
<cueslookup:name key="server.error.5007">
Exceed quota limit
</cueslookup:name>
<cueslookup:name key="server.error.5008">
Insufficient Clean Access packages installed
</cueslookup:name>
<cueslookup:name key="server.error.5009">
Access to network is blocked by the administrator
</cueslookup:name>
<cueslookup:name key="server.error.5010">
Vulnerabilities not fixed
</cueslookup:name>
<cueslookup:name key="server.error.5011">
This client version is old and not compatible. Please login from web browser to see the
download link for the new version.
</cueslookup:name>
<cueslookup:name key="server.error.5012">
Network policy is not accepted
</cueslookup:name>
<cueslookup:name key="server.error.5013">
Invalid switch configuration
</cueslookup:name>
<cueslookup:name key="server.error.5014">
```

```

Too many users using this account
</cueslookup:name>
<cueslookup:name key="server.error.5015">
Invalid session
</cueslookup:name>
<cueslookup:name key="server.error.5016">
Null session
</cueslookup:name>
<cueslookup:name key="server.error.5017">
Invalid user role
</cueslookup:name>
<cueslookup:name key="server.error.5018">
Invalid login page
</cueslookup:name>
<cueslookup:name key="server.error.5019">
Encoding failure
</cueslookup:name>
<cueslookup:name key="server.error.5020">
A security enhancement is required for your Agent. Please upgrade your Agent or contact
your network administrator.
</cueslookup:name>
<cueslookup:name key="server.error.5021">
Can not find server reference
</cueslookup:name>
<cueslookup:name key="server.error.5022">
User role currently disabled
</cueslookup:name>
<cueslookup:name key="server.error.5023">
Authentication server is not reachable
</cueslookup:name>
<cueslookup:name key="server.error.5024">
Agent user operating system is not supported
</cueslookup:name>
<cueslookup:name key="server.error.generic_emergency">
The Agent has encountered an unexpected error and is restarting.
</cueslookup:name>
<cueslookup:name key="server.error.http_error">
Clean Access Server is not available on the network.
</cueslookup:name>
<cueslookup:name key="server.error.nw_interface_chg">
Authentication interrupted due to network status change. Press OK to retry.
</cueslookup:name>
<cueslookup:name key="server.error.svr_misconfigured">
Clean Access Server is not properly configured.
</cueslookup:name>
<cueslookup:name key="server.clarification.generic_emergency">
Please contact your administrator if the problem persists.
</cueslookup:name>
<cueslookup:name key="announce.savingreport">
Saving Report
</cueslookup:name>
<cueslookup:name key="announce.savingreport.failed">
Unable to save report
</cueslookup:name>
<cueslookup:name key="announce.cancelremediationack">
Clicking Cancel may change your network connectivity and interrupt download or required
updates.<p> Do you want to continue?</p>
</cueslookup:name>
<cueslookup:name key="announce.dismiss.default">
Dismiss to continue
</cueslookup:name>
<cueslookup:name key="announce.logoutconfirm">
Successfully logged out from the network!
</cueslookup:name>

```

```
</cueslookup:appstrings>
```



**Note** There is no limit to the number of characters you can use for the customized text. However, Cisco recommends restricting the length so that these fields do not take up too much space in the resulting customized login screen as it appears on the client.

## Sample Extended nacStrings\_xx.xml File

```
<cueslookup:name key="dp.status.fullNetAccess">Full Network Access</cueslookup:name>
<cueslookup:name key="dp.status.fullNetAccess.verbose">Your device conforms with all the
security policies for this protected network</cueslookup:name>
<cueslookup:name key="dp.status.fullNetAccessWarn.verbose">Only optional requirements are
failing. It is recommended that you update your system at your earliest
convenience.</cueslookup:name>
<cueslookup:name key="dp.status.iprefresh.progress.verbose">Refreshing IP address. Please
Wait ...</cueslookup:name>
<cueslookup:name key="dp.status.iprefresh.complete.verbose">Refreshing IP address
succeeded.</cueslookup:name>
<cueslookup:name key="dp.status.vlanchange.progress.verbose">Connecting to protected Network.
Please Wait ...</cueslookup:name>
<cueslookup:name key="dp.status.guestNetAccess">Guest Network Access</cueslookup:name>
<cueslookup:name key="dp.status.noNetAccess">Network Access Denied</cueslookup:name>
<cueslookup:name key="dp.status.noNetAccess.verbose">There is at least one mandatory
requirement failing. You are required to update your system before you can access the
network.
</cueslookup:name><cueslookup:name key="dp.status.rejectNetPolicy.verbose">Network Usage
Terms and Conditions are rejected. You will not be allowed to access the
network.</cueslookup:name>
<cueslookup:name key="dp.status.RestrictedNetAccess">Restricted Network Access
granted.</cueslookup:name>
<cueslookup:name key="dp.status.RestrictedNetAccess.verbose">You have been granted restricted
network access because your device did not conform with all the security policies for this
protected network and you have opted to defer updating your system. It is recommended that
you update your system at your earliest convenience.</cueslookup:name>
<cueslookup:name key="dp.status.temporaryNetAccess">Temporary Network Access</cueslookup:name>

<cueslookup:name key="dp.status.temporaryNetAccess.bepatient.verbose">Please be patient
while your system is checked against the network security policy.</cueslookup:name>
<cueslookup:name key="dp.status.pra.mandatoryfailure">Performing
Re-assessment</cueslookup:name>
<cueslookup:name key="dp.status.pra.mandatoryfailure.verbose">There is at least one mandatory
requirement failing. You are required to update your system otherwise your network access
will be restricted.</cueslookup:name>
<cueslookup:name key="dp.status.pra.optionalfailure">Performing
Re-assessment</cueslookup:name>
<cueslookup:name key="dp.status.pra.optionalfailure.verbose">Only optional requirements are
failing. It is recommended that you update your system at your earliest
convenience.</cueslookup:name>
<cueslookup:name key="dp.status.SessionTimeout">Logged out</cueslookup:name>
<cueslookup:name key="dp.status.SessionTimeout.verbose">Temporary Access to the network has
expired.</cueslookup:name>
<cueslookup:name key="dp.status.Unauthenticated">Logged out</cueslookup:name>
<cueslookup:name key="dp.status.Unauthenticated.verbose"> </cueslookup:name>
```

## UpdateFeed.xml Descriptor File Template

This is one of the files that is required in your Agent screen customization package, allows you to customize the logo, fields, and message text contained in a Cisco NAC Agent dialog, like the Properties screen, to suit your specific Windows client network access requirements.

Before you can complete your Agent screen customization package, you must construct a suitable updateFeed.xml XML descriptor file. Use the following example as a template to set up the updateFeed.xml descriptor file required for your customization package.

```
<?xml version="1.0" encoding="utf-8"?>
<feed xmlns="http://www.w3.org/2005/Atom" xmlns:update="http://www.cisco.com/cpm/update/1.0">

 <title>Provisioning Update</title>
 <updated>2011-12-21T12:00:00Z</updated>
 <id>https://www.cisco.com/web/secure/pmbu/provisioning-update.xml</id>
 <author>
 <name>Cisco Support</name>
 <email>support@cisco.com</email>
 </author>
 <!-- Custom Branding -->
 <entry>
 <id>http://foo.foo.com/foo/AgentCustomizationPackage/1/1/1/7</id>
 <title>Agent Customization Package</title>
 <updated>2010-06-07T12:00:00Z</updated>
 <summary>This is EF Agent Customization Package 1.1.1.7</summary>
 <link rel="enclosure" type="application/zip" href="brand-win.zip" length="18884" />
 <update:type>AgentCustomizationPackage</update:type>
 <update:version>1.1.1.7</update:version>
 <update:os>WINDOWS_ALL</update:os>
 </entry>
</feed>
```

Note the following points while creating the updateFeed.xml descriptor file:

- `<update:os>`—You must always set this attribute to “WINDOWS\_ALL” to include all the Windows OS versions that are supported by Cisco NAC Agent. See [Support Information for Cisco NAC Appliance Agents](#) for the list of Windows OS versions that are supported by Cisco NAC Agent.
- `<update:version>`—This refers to the Agent Customization Package version that you want to upgrade to. This value should be four digit `<n.n.n.n>` and should be greater than the package version that is currently installed.
- `<id>`—This id can be anything, but should be unique for each Agent Customization Package.

## Example XML File Generated Using the Create Profile Function

```
<?xml version="1.0" ?>
<cfg>
 <VlanDetectInterval>0</VlanDetectInterval>
 <RetryDetection>3</RetryDetection>
 <PingArp>0</PingArp>
 <PingMaxTimeout>1</PingMaxTimeout>
 <EnableVlanDetectWithoutUI>0</EnableVlanDetectWithoutUI>
 <SignatureCheck>0</SignatureCheck>
 <DisableExit>0</DisableExit>
 <PostureReportFilter>displayFailed</PostureReportFilter>
 <BypassSummaryScreen>1</BypassSummaryScreen>
 <LogFileSize>5</LogFileSize>
```

```

<DiscoveryHost></DiscoveryHost>
<DiscoveryHostEditable>1</DiscoveryHostEditable>
<Locale>default</Locale>
<AccessibilityMode>0</AccessibilityMode>
<SwissTimeout>1</SwissTimeout>
<HttpDiscoveryTimeout>30</HttpDiscoveryTimeout>
<HttpTimeout>120</HttpTimeout>
<ExceptionMACList></ExceptionMACList>
<GeneratedMAC></GeneratedMAC>
<AllowCRLChecks>1</AllowCRLChecks>
<DisableL3SwissDelay>0</DisableL3SwissDelay>
<ServerNameRules></ServerNameRules>
</cfg>

```




---

**Note** This file also contains two static (that is, uneditable by the user or Cisco ISE administrator) “AgentCfgVersion” and “AgentBrandVersion” parameters used to identify the current version of the agent profile and agent customization file, respectively, on the client.

---

## Configure Client Provisioning Resource Policies

For clients, the client provisioning resource policies determine which users receive which version of resources (agents, agent compliance modules, and agent customization packages or profiles) from Cisco ISE upon login and user session initiation.

For AnyConnect, resources can be selected from the **Client Provisioning Resources** window to create an AnyConnect configuration that you can use in the **Client Provisioning Policy** window. AnyConnect configuration specifies the AnyConnect software and its association with different configuration files that includes AnyConnect binary package for Windows and macOS clients, compliance module, module profiles, customization, and language packages.

For Cisco ISE NAC agents, resources can be selected from the **Client Provisioning** window.

### Before you begin

- Before you can create effective client-provisioning resource policies, ensure that you have added resources to Cisco ISE. When you download the agent compliance module, it always overwrites the existing one, if any, available in the system.
- Check the native supplicant profile that is used in the client provisioning policy and ensure that the wireless SSID is correct. For iOS devices, if the network that you are trying to connect is hidden, check the **Enable if target network is hidden** check box in the **iOS Settings** area.

---

**Step 1** Choose **Policy > Client Provisioning**.

**Step 2** From the **Behavior** drop-down list, choose one of the following options:

- **Enable:** Ensures Cisco ISE uses this policy to help fulfill client-provisioning functions when users log in to the network and conform to the client-provisioning policy guidelines.
- **Disable:** Cisco ISE does not use the specified resource policy to fulfill client-provisioning functions.

- **Monitor:** Disables the policy and “watches” the client-provisioning session requests to see how many times Cisco ISE tries to invoke based on the “Monitored” policy.

**Step 3** Enter a name for the new resource policy in the **Rule Name** text box.

**Step 4** Specify one or more Identity Groups to which a user who logs into Cisco ISE might belong.

You can choose to specify the **Any** identity group type, or choose one or more groups from a list of existing Identity Groups that you have configured.

**Step 5** Use the **Operating Systems** field to specify one or more operating systems that might be running on the client machine or device through which the user is logging into Cisco ISE.

You can choose to specify a single operating system like Android, Mac iOS, macOS or an umbrella operating system designation that addresses a number of client machine operating systems like Windows XP (All) or Windows 7 (All).

**Note** Though the option to select macOS 10.6, 10.7, and 10.8 is available in the **Client Provisioning** window in Cisco ISE GUI, these versions are not supported by AnyConnect.

**Step 6** In the **Other Conditions** field, specify a new expression that you want to create for this particular resource policy.

**Step 7** For client machines, use the **Agent Configuration** option to specify which agent type, compliance module, agent customization package, and profile to make available and provision on the client machine.

It is mandatory to include the client provisioning URL in authorization policy to enable the agent to popup in the client machines. This prevents request from any random clients and ensures that only clients with proper redirect URL can request for posture assessment.

**Step 8** Click **Save**.

### What to do next

After you have successfully configured one or more client provisioning resource policies, you can start to configure Cisco ISE to perform posture assessment on client machines during login.

## Configure Cisco ISE Posture Agent in the Client Provisioning Policy

For client machines, configure the agent type, compliance module, agent customization package, and/or profile to make available and provision for users to download and install on the client machine.

### Before you begin

You must add client provisioning resources for AnyConnect and Cisco ISE NAC in Cisco ISE.

**Step 1** Choose an available agent from the **Agent** drop-down list and specify whether the agent upgrade (download) defined here is mandatory for the client machine by enabling or disabling the **Is Upgrade Mandatory** option, as appropriate.

The **Is Upgrade Mandatory** setting only applies to agent downloads. Agent profile, compliance module, and agent customization package updates are always mandatory.

**Step 2** Choose an existing agent profile from the **Profile** drop-down list.

**Step 3** Choose an available compliance module to download to the client machine using the **Compliance Module** drop-down list.

- Step 4** Choose an available agent customization package for the client machine from the **Agent Customization Package** drop-down list.
- 

## Configure Native Supplicants for Personal Devices

Employees can connect their personal devices to the network directly using native supplicants, which are available for Windows, Mac OS, iOS, and Android devices. For personal devices, specify which Native Supplicant configuration to make available and provision on the registered personal device.

### Before you begin

Create native supplicant profiles so that when user log in, based on the profile that you associate with that users authorization requirements, Cisco ISE provides the necessary supplicant provisioning wizard to set up the users personal devices to access the network.

---

- Step 1** Choose **Policy > Client Provisioning**.
- Step 2** Choose **Enable**, **Disable**, or **Monitor** from the behavior drop-down list.
- Step 3** Enter a name for the new resource policy in the Rule Name text box.
- Step 4** Specify the following:
- Use the **Identity Groups** field to specify one or more Identity Groups to which a user who logs into Cisco ISE might belong.
  - Use the **Operating System** field to specify one or more operating systems that might be running on the personal device through which the user is logging into Cisco ISE.
  - Use the **Other Conditions** field to specify a new expression that you want to create for this particular resource policy.
- Step 5** For personal devices, use **Native Supplicant Configuration** to choose the specific **Configuration Wizard** to distribute to these personal devices.
- Step 6** Specify the applicable **Wizard Profile** for the given personal device type.
- Step 7** Click **Save**.
- 

## Client Provisioning Reports

You can access the Cisco ISE monitoring and troubleshooting functions to check on overall trends for successful or unsuccessful user login sessions, gather statistics about the number and types of client machines logging into the network during a specified time period, or check on any recent configuration changes in client provisioning resources.

### Client Provisioning Requests

The **Operations > Reports > ISE Reports > Endpoints and Users > Client Provisioning** report displays statistics about successful and unsuccessful client provisioning requests. When you choose **Run** and specify one of the preset time periods, Cisco ISE combs the database and displays the resulting client provisioning data.

### Supplicant Provisioning Requests

The **Operations > Reports > ISE Reports > Endpoints and Users > Supplicant Provisioning** window displays information about recent successful and unsuccessful user device registration and supplicant provisioning requests. When you choose **Run** and specify one of the preset time periods, Cisco ISE combs the database and displays the resulting supplicant provisioning data.

The Supplicant Provisioning report provides information about a list of endpoints that are registered through the device registration portal for a specific period of time, including data like the Logged at Date and Time, Identity (user ID), IP Address, MAC Address (endpoint ID), Server, profile, Endpoint Operating System, SPW Version, Failure Reason (if any), and the Status of the registration.

## Client Provisioning Event Logs

You can search event log entries to help diagnose a possible problem with client login behavior. For example, you may need to determine the source of an issue where client machines on your network are not able to get client provisioning resource updates upon login. You can use logging entries for Posture and Client Provisioning Audit and Posture and Client Provisioning Diagnostics.





## CHAPTER 26

# Configure Client Posture Policies

Posture is a service in Cisco Identity Services Engine (Cisco ISE) that allows you to check the state, also known as posture, of all the endpoints that are connecting to a network for compliance with corporate security policies. This allows you to control clients to access protected areas of a network.

- [Posture Service, on page 758](#)
- [Posture Administration Settings, on page 761](#)
- [Download Posture Updates to Cisco ISE, on page 765](#)
- [Configure Acceptable Use Policies for Posture Assessment, on page 767](#)
- [Posture Conditions, on page 767](#)
- [Simple Posture Conditions, on page 767](#)
- [Create Simple Posture Conditions, on page 768](#)
- [Compound Posture Conditions, on page 768](#)
- [Predefined Condition for Enabling Automatic Updates in Windows Clients, on page 769](#)
- [Preconfigured Antivirus and Antispyware Conditions, on page 769](#)
- [Antivirus and Antispyware Support Chart, on page 769](#)
- [Compliance Module, on page 770](#)
- [Create Compound Posture Conditions, on page 771](#)
- [Create Patch Management Conditions, on page 772](#)
- [Create Disk Encryption Conditions, on page 772](#)
- [Configure Posture Policies, on page 773](#)
- [Configure AnyConnect Workflow, on page 774](#)
- [Posture Assessment Options, on page 775](#)
- [Posture Remediation Options, on page 776](#)
- [Custom Conditions for Posture, on page 777](#)
- [Custom Posture Remediation Actions, on page 777](#)
- [Posture Assessment Requirements, on page 781](#)
- [Custom Permissions for Posture, on page 783](#)
- [Configure Standard Authorization Policies, on page 784](#)
- [Stealth Mode Deployment, on page 785](#)
- [Impact of Stealth Mode on Posture Policy and Requirement Types, on page 786](#)
- [Best Practices for Network Drive Mapping with Posture, on page 788](#)
- [Configure AnyConnect Clientless Mode Workflow, on page 788](#)

# Posture Service

Posture is a service in Cisco Identity Services Engine (Cisco ISE) that allows you to check the compliance, also known as posture, of endpoints, before allowing them to connect to your network. A posture agent, such as the AnyConnect ISE Posture Agent or Network Admission Control (NAC) Agent, runs on the endpoint. Client Provisioning ensures that the endpoints receive the appropriate Posture Agent.

The ISE Posture Agent for Cisco ISE does not support Windows Fast User Switching when using the native supplicant, because there is no clear disconnect of the previous user. When a new user is sent, the Agent is hung on the old user process and session ID, so a new posture session cannot start. As per the Microsoft Security policies, it is recommended to disable Fast User Switching.



**Note** In ISE, session control is done on multiple nodes.

On an MnT node, sessions are removed:

- If there was accounting start, but no accounting stop (stale session), the session is removed in five days.
- If there was accounting start followed by accounting stop, the session is removed in a few hours.
- If there was no accounting start or stop, the session is removed in a few hours.

On a PSN node, sessions are removed:

- When accounting stop is received.
- When the session cache is cleared, especially when there are many sessions, or you reload the PSN.

If posture without redirection is used in multinode deployment, and sessions are not properly managed, it may impact the posture functionality.

## ISE Community Resource

[Configure ISE 2.1 and AnyConnect 4.3 Posture USB Check](#)

[How To Configure Posture with AnyConnect Compliance Module and ISE 2.0](#)

## Related Topics

[Components of Posture Services](#), on page 758

[Posture and Client-Provisioning Policies Workflow](#), on page 760

[Posture Service Licenses](#), on page 760

# Components of Posture Services

Cisco ISE posture service primarily includes the posture administration services and the posture run-time services.

### Posture Administration Services

If you have not registered the Cisco ISE Apex license in Cisco ISE, then the posture administration services option is not available in the Cisco ISE administration portal.

Administration services provide the back-end support for posture-specific custom conditions and remediation actions that are associated with the requirements and authorization policies that are configured for posture service.

### Posture Run-Time Services

The posture run-time services encapsulate all the interactions that happen between the client agent and the Cisco ISE server for posture assessment and remediation of clients.

Posture run-time services begin with the Discovery Phase. An endpoint session is created after the endpoint passes 802.1x authentication. The client agent then attempts to connect to a Cisco ISE node by sending discovery packets through different methods in the following order:

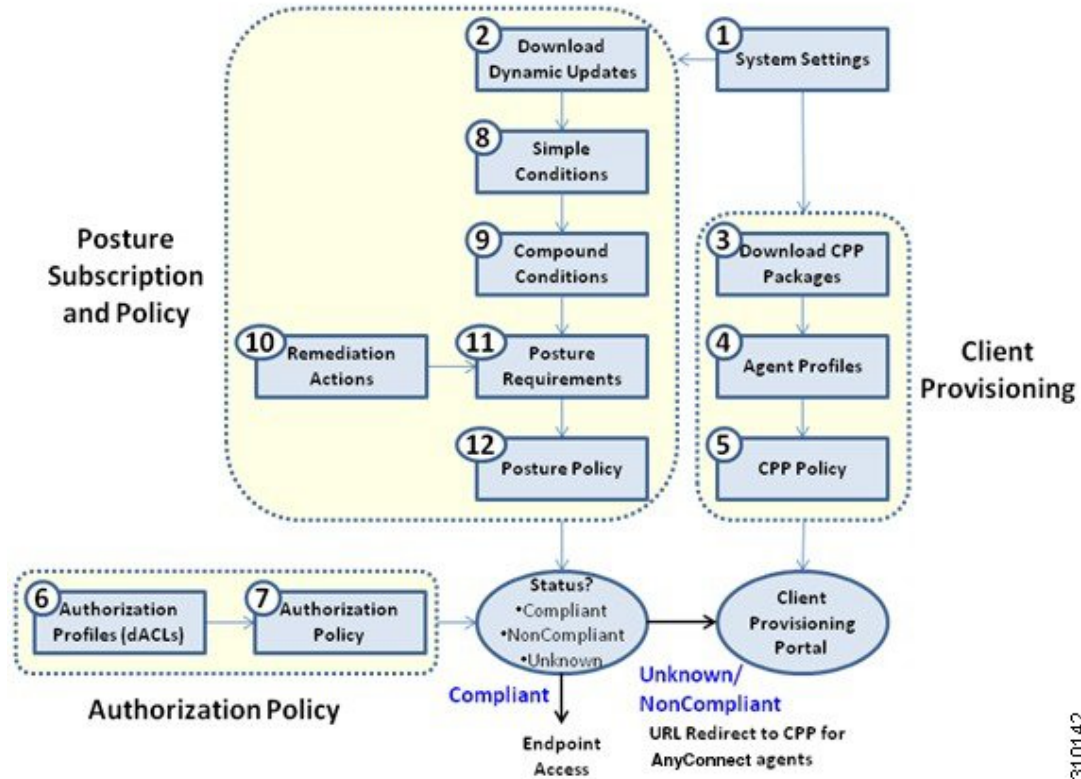
1. via HTTP to Port 80 on a Cisco ISE server (if configured)
2. via HTTPS to Port 8905 on a Cisco ISE server (if configured)
3. via HTTP to Port 80 on the default gateway
4. via HTTPS to Port 8905 to each previously contact server
5. via HTTP to Port 80 on enroll.cisco.com

The Posture Phase begins when the Acceptable User Policy (if any) is accepted. The Cisco ISE node issues a posture token for the Posture Domain to the client agent. The posture token allows the endpoint to reconnect to the network without going through the posture process again. It contains information such as the Agent GUID, the Acceptable User Policy status, and endpoint operating system information.

The messages used in the Posture Phase are in the NEA PB/PA format (RFC5792).

# Posture and Client-Provisioning Policies Workflow

Figure 56: Posture and Client Provisioning Policies Workflow in Cisco ISE



In Stage 1 of posture discovery, all discovery probes execute at the same time by the Posture agent. The timeout value is 5 seconds. Stage two contains two discovery probes, which allows the posture module to establish a connection to the PSN. This connection to the PSN supports authentication in environments where redirection is not supported. During stage two, all probes are sequential. If stage 2 fails, the posture agent tries stage 1 again. This cycle continues for 30 seconds, after which you see "No policy server detected". This state continues until a discovery probe triggers.

## Posture Service Licenses

Cisco ISE provides you with three types of licenses, the Base license, the Plus license, and the Apex license. If you have not installed the Apex license on the Primary PAN, then the posture requests will not be served in Cisco ISE. The posture service of Cisco ISE can run on a single node or on multiple nodes.

## Posture Service Deployment

You can deploy Cisco ISE in a standalone environment (on a single node) or in a distributed environment (on multiple nodes).

In a standalone Cisco ISE deployment, you can configure a single node for all the administration services, the monitoring and troubleshooting services, and the policy run-time services.

In a distributed Cisco ISE deployment, you can configure each node as a Cisco ISE node for administration services, monitoring and troubleshooting services, and policy run-time services. A node that runs the administration services is the primary node in that Cisco ISE deployment. The other nodes that run other services are the secondary nodes which can be configured for backup services for one another.

## Enable Posture Session Service in Cisco ISE

### Before you begin

- You must enable session services in Cisco ISE and install the advanced license package to serve all the posture requests received from the clients.
- If you have more than one node that is registered in a distributed deployment, all the nodes that you have registered appear in the Deployment Nodes page, apart from the primary node. You can configure each node as a Cisco ISE node (Administration, Policy Service, and Monitoring personas).
- The posture service only runs on Cisco ISE nodes that assume the Policy Service persona and does not run on Cisco ISE nodes that assume the administration and monitoring personas in a distributed deployment.

- 
- Step 1** Choose **Administration** > **System** > **Deployment** > **Deployment**.
- Step 2** Choose a Cisco ISE node from the Deployment Nodes window.
- Step 3** Click **Edit**.
- Step 4** Under the **General Settings** tab, check the **Policy Service** check box,  
If the Policy Service check box is unchecked, both the session services and the profiling service check boxes are disabled.
- Step 5** Check the **Enable Session Services** check box, for the Policy Service persona to run the Network Access, Posture, Guest, and Client Provisioning session services. To stop the session services, uncheck the check box.
- Step 6** Click **Save**.
- 

## Run the Posture Assessment Report

You can run the Posture Detail Assessment report to generate a detailed status of compliance of the clients against the posture policies that are used during posture assessment.

- 
- Step 1** Choose **Operations** > **Reports** > **ISE Reports** > **Endpoints and Users** > **Posture Detail Assessment**.
- Step 2** From the **Time Range** drop-down list, choose the specific time period.
- Step 3** Click **Run** to view the summary of all the end points that were active during the selected time period.
- 

## Posture Administration Settings

You can globally configure the Admin portal for posture services. You can download updates automatically to the Cisco ISE server through the web from Cisco. You can also update Cisco ISE manually offline later.

In addition, having an agent like AnyConnect, the NAC Agent, or the Web Agent installed on the clients provides posture assessment and remediation services to clients. The client agent periodically updates the compliance status of clients to Cisco ISE. After login and successful requirement assessment for posture, the client agent displays a dialog with a link that requires end users to comply with terms and conditions of network usage. You can use this link to define network usage information for your enterprise network that end users accept before they can gain access to your network.

#### Related Topics

[Timer Settings for Clients](#), on page 762

[Set Posture Status for Nonagent Devices](#), on page 763

[Posture Lease](#), on page 764

[Configure Acceptable Use Policies for Posture Assessment](#), on page 767

## Timer Settings for Clients

You can set up timers for users to remediate, to transition from one state to another, and to control the login success screen.

However, when there are no agent profiles configured to match the client provisioning policies, you can use the settings in the **General Settings** configuration window ( **Administration** > **System** > **Settings** > **Posture** > **General Settings**).

#### Related Topics

[Set Remediation Timer for Clients to Remediate Within Specified Time](#), on page 762

[Set Network Transition Delay Timer for Clients to Transition](#), on page 762

[Set Login Success Window to Close Automatically](#), on page 763

### Set Remediation Timer for Clients to Remediate Within Specified Time

You can configure the timer for client remediation within a specified time. When clients fail to satisfy configured posture policies during an initial assessment, the agent waits for the clients to remediate within the time configured in the remediation timer. If the client fails to remediate within this specified time, then the client agent sends a report to the posture run-time services after which the clients are moved to the noncompliance state.

---

**Step 1** Choose **Administration** > **System** > **Settings** > **Posture** > **General Settings**.

**Step 2** In the **Remediation Timer** field, enter a time value in minutes.

The default value is 4 minutes. The valid range is 1–300 minutes.

**Step 3** Click **Save**.

---

### Set Network Transition Delay Timer for Clients to Transition

You can configure the timer for clients to transition from one state to the other state within a specified time using the network transition delay timer, which is required for Change of Authorization (CoA) to complete. It may require a longer delay time when clients need time to get a new VLAN IP address during success and failure of posture. When successfully postured, Cisco ISE allows clients to transition from unknown to

compliant mode within the time specified in the network transition delay timer. Upon failure of posture, Cisco ISE allows clients to transition from unknown to noncompliant mode within the time specified in the timer.

- 
- Step 1** Choose **Administration > System > Settings > Posture > General Settings**.
- Step 2** Enter a time value in seconds, in the **Network Transition Delay** field.  
The default value is 3 seconds. The valid range is 2 to 30 seconds.
- Step 3** Click **Save**.
- 

## Set Login Success Window to Close Automatically

After successful posture assessment, the client agent displays a temporary network access screen. The user needs to click the **OK** button in the login window to close it. You can set up a timer to close this login screen automatically after specified time.

- 
- Step 1** Choose **Administration > System > Settings > Posture > General Settings**.
- Step 2** Check the **Automatically Close Login Success Screen After** check box.
- Step 3** Enter a time value in seconds, in the field next to **Automatically Close Login Success Screen After** check box.  
The valid range is 0 to 300 seconds. If the time is set to zero, then AnyConnect does not display the login success screen.
- Step 4** Click **Save**.
- 

## Set Posture Status for Nonagent Devices

You can configure the posture status of endpoints that run on non-agent devices. When Android devices and Apple devices such as an iPod, iPhone, or iPad connect to a Cisco ISE enabled network, these devices assume the Default Posture Status settings.

These settings can also be applied to endpoints that run on Windows and Macintosh operating systems when a matching client provisioning policy is not found during posture runtime while redirecting the endpoints to the client provisioning portal.

### Before you begin

In order to enforce policy on an endpoint, you must configure a corresponding Client Provisioning policy (Agent installation package). Otherwise, the posture status of the endpoint automatically reflects the default setting.

- 
- Step 1** Choose **Administration > System > Settings > Posture > General Settings**.
- Step 2** From the **Default Posture Status** drop-down list, choose the option as **Compliant** or **Noncompliant**.
- Step 3** Click **Save**.
-

## Posture Lease

You can configure Cisco ISE to perform posture assessment every time a user logs into your network or perform posture assessment in specified intervals. The valid range is from 1 to 365 days.

This configuration applies only for those who use AnyConnect agent for posture assessment.

When the posture lease is active, Cisco ISE will use the last known posture state and will not reach out to the endpoint to check for compliance. But when the posture lease expires, Cisco ISE does not automatically trigger a re-authentication or a posture reassessment for the endpoint. The endpoint will stay in the same compliance state since the same session is being used. When the endpoint re-authenticates, posture will be run and the posture lease time will be reset.

Example Use Case Scenario:

- The user logs on to the endpoint and gets it posture compliant with the posture lease set to one day.
- Four hours later the user logs off from the endpoint (the posture lease now has 20 hours left).
- One hour later the user logs on again. Now the posture lease has 19 hours left. The last known posture state was compliant. Hence the user is provided access without posture being run on the endpoint.
- Four hours later the user logs off (the posture lease now has 15 hours left).
- 14 hours later, the user logs on. The posture lease has one hour left. The last known posture state was compliant. The user is provided access without posture being run on the endpoint.
- One hour later, the posture lease expires. The user is still connected to the network as the same user session is being used.
- One hour later, user logs off (the session is tied to the user but not to the machine, so the machine can stay on the network).
- One hour later the user logs on. Since the posture lease has expired and a new user session is launched, the machine performs a posture assessment, the results are sent to the Cisco ISE and the posture lease timer is reset to one day in case of this use case.

## Periodic Reassessments

Periodic reassessment (PRA) can be done only for clients that are already successfully postured for compliance. PRA cannot occur if clients are not compliant on your network.

A PRA is valid and applicable only if the endpoints are in a compliant state. The policy service node checks the relevant policies, and compiles the requirements depending on the client role that is defined in the configuration to enforce a PRA. If a PRA configuration match is found, the policy service node responds to the client agent with the PRA attributes that are defined in the PRA configuration for the client before issuing a CoA request. The client agent periodically sends the PRA requests based on the interval specified in the configuration. The client remains in the compliant state if the PRA succeeds, or the action configured in the PRA configuration is to continue. If the client fails to meet PRA, then the client is moved from the compliant state to the noncompliant state.

The PostureStatus attribute shows the current posture status as compliant in a PRA request instead of unknown even though it is a posture reassessment request. The PostureStatus is updated in the Monitoring reports as well.



When the posture lease has not expired, an endpoint becomes compliant based on the Access Control List (ACL), and PRA is initiated. If PRA fails, the endpoint is deemed noncompliant and the posture lease is reset.



---

**Note** PRA is not supported during PSN failover. After PSN failover, you must either enable rescan on the client or enable posture lease.

---

## Configure Periodic Reassessments

You can configure periodic reassessments only for clients that are already successfully postured for compliance. You can configure each PRA to a user identity group that is defined in the system.

### Before you begin

- Ensure that each Periodic reassessment (PRA) configuration has a unique group or a unique combination of user identity groups assigned to the configuration.
- You can assign a `role_test_1` and a `role_test_2`, which are the two unique roles to a PRA configuration. You can combine these two roles with a logical operator and assign the PRA configuration as a unique combination of two roles. For example, `role_test_1 OR role_test_2`.
- Ensure that two PRA configurations do not have a user identity group in common.
- If a PRA configuration already exists with a user identity group *Any*, you cannot create other PRA configurations unless you perform one of the following:
  - Update the existing PRA configuration with the *Any* user identity group to reflect a user identity group other than *Any*.
  - Delete the existing PRA configuration with a user identity group “*Any*”.

---

**Step 1** Choose **Administration** > **System** > **Settings** > **Posture** > **Reassessments**.

**Step 2** Click **Add**.

**Step 3** Modify the values in the **New Reassessment Configuration** window to create a new PRA.

**Step 4** Click **Submit** to create a PRA configuration.

---

### Related Topics

[Periodic Reassessments](#), on page 764

## Download Posture Updates to Cisco ISE

Posture updates include a set of predefined checks, rules, and support charts for antivirus and antispyware for both Windows and Macintosh operating systems, and operating systems information that are supported by Cisco. You can also update Cisco ISE offline from a file on your local system, which contains the latest archives of updates.

When you deploy Cisco ISE on your network for the first time, you can download posture updates from the web. This process usually takes approximately 20 minutes. After the initial download, you can configure Cisco ISE to verify and download incremental updates to occur automatically.

Cisco ISE creates default posture policies, requirements, and remediations only once during an initial posture updates. If you delete them, Cisco ISE does not create them again during subsequent manual or scheduled updates.

### Before you begin

To ensure that you are able to access the appropriate remote location from which you can download posture resources to Cisco ISE, you may be required to verify that you have the correct proxy settings configured for your network as described in *Specifying Proxy Settings in Cisco ISE*.

You can use the Posture Update window to download updates dynamically from the web.

---

**Step 1** Choose **Administration > System > Settings > Posture > Updates**.

**Step 2** Choose the **Web** option to download updates dynamically.

**Step 3** Click **Set to Default** to set the Cisco default value for the **Update Feed URL** field.

If your network restricts URL-redirectation functions (via a proxy server, for example) and you are experiencing difficulty accessing the above URL, try also pointing your Cisco ISE to the alternative URL in the related topics.

**Step 4** Modify the values in the **Posture Updates** window.

**Step 5** Click **Update Now** to download updates from Cisco.

After being updated, the Posture Updates window displays the current Cisco updates version information as a verification of an update under Update Information section in the Posture Updates window.

**Step 6** Click **Yes** to continue.

---

### Related Topics

[Download Posture Updates Automatically](#), on page 766

## Download Posture Updates Automatically

After an initial update, you can configure Cisco ISE to check for the updates and download them automatically.

### Before you begin

- You should have initially downloaded the posture updates to configure Cisco ISE to check for the updates and download them automatically.

---

**Step 1** Choose **Administration > System > Settings > Posture > Updates**.

**Step 2** In the **Posture Updates** window, check the **Automatically check for updates starting from initial delay** check box.

**Step 3** Enter the initial delay time in hh:mm:ss format.

Cisco ISE starts checking for updates after the initial delay time is over.

**Step 4** Enter the time interval in hours.

Cisco ISE downloads the updates to your deployment at specified intervals from the initial delay time.

**Step 5** Click **Save**.

---

## Configure Acceptable Use Policies for Posture Assessment

After login and successful posture assessment of clients, the client agent displays a temporary network access screen. This screen contains a link to an acceptable use policy (AUP). When the user clicks the link, they are redirected to a page that displays the network-usage terms and conditions, which they must read and accept.

Each Acceptable Use Policy configuration must have a unique user identity group, or a unique combination of user identity groups. Cisco ISE finds the AUP for the first matched user identity group, and then it communicates to the client agent that displays the AUP.

---

**Step 1** Choose **Administration > System > Settings > Posture > Acceptable Use Policy**.

**Step 2** Click **Add**.

**Step 3** Modify the values in the **New Acceptable Use Policy Configuration** window.

**Step 4** Click **Submit**.

---

## Posture Conditions

A posture condition can be any one of the following simple conditions: a file, a registry, an application, a service, or a dictionary condition. One or more conditions from these simple conditions form a compound condition, which can be associated to a posture requirement.

When you deploy Cisco ISE on your network for the first time, you can download posture updates from the web. This process is called the initial posture update.

After an initial posture update, Cisco ISE also creates Cisco defined simple and compound conditions. Cisco defined simple conditions have `pc_` as their prefixes and compound conditions have `pr_` as their prefixes.

You can also configure Cisco ISE to download the Cisco-defined conditions periodically as a result of dynamic posture updates through the web. You cannot delete or edit Cisco defined posture conditions.

A user defined condition or a Cisco defined condition includes both simple conditions and compound conditions.

## Simple Posture Conditions

You can use the **Posture Navigation** pane to manage the following simple conditions:

- **File Conditions:** A condition that checks the existence of a file, the date of a file, and the versions of a file on the client.
- **Registry Conditions:** A condition that checks for the existence of a registry key or the value of the registry key on the client.

- **Application Conditions:** A condition that checks if an application or process is running or not running on the client.




---

**Note** If a process is installed and running, user is compliant. However, the Application condition works in reverse logic; If an application is not installed and not running, the end user is compliant. If an application is installed and running, the end user is non-complaint.

---

- **Service Conditions:** A condition that checks if a service is running or not running on the client.
- **Dictionary Conditions:** A condition that checks a dictionary attribute with a value.
- **USB Conditions:** A condition that checks for the presence of USB mass storage device.

#### Related Topics

- [File Condition Settings](#), on page 1094
- [Registry Condition Settings](#), on page 1099
- [Application Condition Settings](#), on page 1100
- [Service Condition Settings](#), on page 1103
- [Dictionary Simple Condition Settings](#), on page 1110
- [USB Condition Settings](#), on page 1115

## Create Simple Posture Conditions

You can create file, registry, application, service, and dictionary simple conditions that can be used in posture policies or in other compound conditions.

#### Before you begin

To perform the following task, you must be a Super Admin or Policy Admin.

- 
- Step 1** Choose **Policy > Policy Elements > Conditions > Posture**.
  - Step 2** Choose any one of the following: **File, Registry, Application, Service, or Dictionary Simple Condition**.
  - Step 3** Click **Add**.
  - Step 4** Enter the appropriate values in the fields.
  - Step 5** Click **Submit**.
- 

## Compound Posture Conditions

Compound conditions are made up of one or more simple conditions, or compound conditions. You can make use of the following compound conditions while defining a Posture policy.

- Compound Conditions: Contains one or more simple conditions, or compound conditions of the type File, Registry, Application, or Service condition
- Antivirus Compound Conditions: Contains one or more AV conditions, or AV compound conditions
- Antispyware Compound Conditions: Contains one or more AS conditions, or AS compound conditions
- Dictionary Compound Conditions: Contains one or more dictionary simple conditions or dictionary compound conditions
- Antimalware Conditions: Contains one or more AM conditions.

## Predefined Condition for Enabling Automatic Updates in Windows Clients

The `pr_AutoUpdateCheck_Rule` is a Cisco predefined condition, which is downloaded to the Compound Conditions window. This condition allows you to check whether the automatic updates feature is enabled on Windows clients. If a Windows client fails to meet this requirement, then the Network Access Control (NAC) Agents enforce the Windows client to enable (remediate) the automatic updates feature. After this remediation is done, the Windows client becomes posture compliant. The Windows update remediation that you associate in the posture policy overrides the Windows administrator setting, if the automatic updates feature is not enabled on the Windows client.

## Preconfigured Antivirus and Antispyware Conditions

Cisco ISE loads preconfigured antivirus and antispyware compound conditions in the AV and AS Compound Condition windows, which are defined in the antivirus and antispyware support charts for Windows and Macintosh operating systems. These compound conditions can check if the specified antivirus and antispyware products exist on all the clients. You can also create new antivirus and antispyware compound conditions in Cisco ISE.

## Antivirus and Antispyware Support Chart

Cisco ISE uses an antivirus and antispyware support chart, which provides the latest version and date in the definition files for each vendor product. Users must frequently poll antivirus and antispyware support charts for updates. The antivirus and antispyware vendors frequently update antivirus and antispyware definition files, look for the latest version and date in the definition files for each vendor product.

Each time the antivirus and antispyware support chart is updated to reflect support for new antivirus and antispyware vendors, products, and their releases, the agents receive a new antivirus and antispyware library. It helps the Agents to support newer additions. Once the agents retrieve this support information, they check the latest definition information from the periodically updated `se-checks.xml` file (which is published along with the `se-rules.xml` file in the `se-templates.tar.gz` archive), and determine whether clients are compliant with the posture policies. Depending upon what is supported by the antivirus and antispyware library for a particular antivirus, or antispyware product, the appropriate requirements will be sent to the agents for validating their existence, and the status of particular antivirus and antispyware products on the clients during posture validation.

For more information on the antivirus and anti-malware products supported by the ISE posture agent, see the Cisco AnyConnect ISE Posture Support Charts: [Cisco ISE Compatibility Guide](#).

You can verify the minimum compliance module version while creating an anti-malware posture condition. After the posture feed is updated, choose **Work Centers > Posture > Policy Elements > Anti-Malware Condition** and then choose the **Operating System** and **Vendor** to view the support chart.



**Note** Some of the Anti-Malware endpoint security solutions (such as FireEye, Cisco AMP, Sophos, and so on) require network access to their respective centralized service for functioning. For such products, AnyConnect ISE posture module (or OESIS library) expects the endpoints to have internet connectivity. It is recommended that internet access is allowed for such endpoints during pre-posture for these online agents (if offline detection is not enabled). Signature Definition condition might not be applicable in such cases.

## Compliance Module

The compliance module contains a list of fields, such as vendor name, product version, product name, and attributes provided by OPSWAT that supports Cisco ISE posture conditions.

Vendors frequently update the product version and date in the definition files, therefore, you must look for the latest version and date in the definition files for each vendor product by frequently polling the compliance module for updates. Each time the compliance module is updated to reflect the support for new vendors, products, and their releases, the AnyConnect agent receives a new library. It helps the AnyConnect agent to support newer additions. The AnyConnect agent retrieves this support information and checks the latest definition information from the periodically updated se-checks.xml file (which is published along with the se-rules.xml file in the se-templates.tar.gz archive), and determine whether clients are compliant with the posture policies. Depending upon what is supported by the library for a particular antivirus, antispymware, antimalware, disk encryption, or patch management product, the appropriate requirements will be sent to the AnyConnect agent for validating their existence, and the status of the particular products on the clients during posture validation.

The compliance module is available on [Cisco.com](#).

Table given below lists the OPSWAT API versions that support and do not support the ISE posture policy. There are different policy rules for agents that support versions 3 and 4.

**Table 65: OPSWAT API Versions**

Posture Condition	Compliance Module Version
OPSWAT	
Antivirus	3.x or earlier
Antispymware	3.x or earlier
Antimalware	4.x or later
Disk Encryption	3.x or earlier and 4.x or later
Patch Management	3.x or earlier and 4.x or later

Posture Condition	Compliance Module Version
USB	4.x or later
Non-OPSWAT	
File	Any version
Application	Any version
Compound	Any version
Registry	Any version
Service	Any version



**Note**

- Be sure to create separate posture policies for version 3.x or earlier and version 4.x or later, in anticipation of clients that may have installed any one of the above versions.
- OESIS version 4 support is provided for compliance module 4.x and Cisco AnyConnect 4.3 and higher. However, AnyConnect 4.3 supports both OESIS version 3 and version 4 policies.
- Version 4 compliance module is supported by ISE 2.1 and higher.

## Create Compound Posture Conditions

You can create compound conditions that can be used in posture policies for posture assessment and validation.

### Before you begin

To perform the following task, you must be a Super Admin or Policy Admin.

- Step 1** Choose **Policy > Policy Elements > Conditions > Posture > Compound Conditions > Add**.
- Step 2** Enter appropriate values for the fields.
- Step 3** Click **Validate Expression** to validate the condition.
- Step 4** Click **Submit**.

### Related Topics

- [Posture Conditions](#), on page 551
- [Simple Posture Conditions](#), on page 551
- [Compound Posture Conditions](#), on page 552
- [Predefined Condition for Enabling Automatic Updates in Windows Clients](#), on page 552
- [Preconfigured Antivirus and Antispyware Conditions](#), on page 552

# Create Patch Management Conditions

You can create a policy to check the status of a selected vendor's patch management product.

For example, you can create a condition to check if Microsoft System Center Configuration Manager (SCCM), Client Version 4.x software product is installed at an endpoint.



**Note** Supported versions of Cisco ISE and AnyConnect:

- Cisco ISE version 1.4 and later
- AnyConnect version 4.1 and later

## Before you begin

To perform the following task, you must be a Super Admin or Policy Admin.

- 
- Step 1** Choose **Policy > Policy Elements > Conditions > Posture > Patch Management Condition**.
  - Step 2** Click **Add**.
  - Step 3** Enter the condition name and description in the **Name** and **Description** fields.
  - Step 4** Choose the appropriate operating system from the **Operating System** drop-down field.
  - Step 5** Choose the **Compliance Module** from the drop-down list.
  - Step 6** Choose the **Vendor Name** from the drop-down list.
  - Step 7** Choose the **Check Type**.
  - Step 8** Choose the appropriate patch from the **Check patches installed** drop-down list.
  - Step 9** Click **Submit**.
- 

## Related Topics

[Patch Management Condition Settings](#), on page 1112

[Add a Patch Management Remediation](#), on page 778

# Create Disk Encryption Conditions

You can create a policy to check if an end point is compliant with the specified data encryption software.

For example, you can create a condition to check if the C: drive is encrypted in an end point. If the C: drive is not encrypted then the end point receives a non-compliance notification and ISE logs a message.

## Before you begin

To perform the following task, you must be a Super Admin or Policy Admin. You can associate a Disk Encryption condition with a posture requirement only when you use the AnyConnect ISE posture agent.



- 
- Step 1** Choose **Policy > Policy Elements > Conditions > Posture > Disk Encryption Condition**.
- Step 2** Click **Add**.
- Step 3** In the **Disk Encryption Condition** window, enter the appropriate values in the fields.
- Step 4** Click **Submit**.
- 

## Configure Posture Policies

A posture policy is a collection of posture requirements that are associated with one or more identity groups and operating systems. The Dictionary Attributes are optional conditions that can be used along with the identity groups and the operating systems to define different policies for the devices.

See the section "Posture Policy" in [ISE Posture Prescriptive Deployment Guide](#) for more information.

### Before you begin

- You must understand the Acceptable Use Policy (AUP).
- You must understand periodic reassessments (PRA).

- 
- Step 1** Choose **Policy > Posture** .
- Step 2** Use the drop-down arrow to add a new policy.
- Step 3** To edit the profile, either double-click a policy or click Edit at the end of the row.
- Step 4** From the **Rule Status** drop-down list, choose **Enabled** or **Disabled**.
- Step 5** (Optional) Drag the slider named **Delayed Notification** to delay the grace period prompt from being displayed to the user until a specific percentage of grace period has elapsed. For example, if the notification delay period is set to 50% and the configured grace period is 10 minutes, Cisco ISE checks the posture status after 5 minutes and displays the grace period notification if the endpoint is found to be noncompliant. Grace period notification is not displayed if the endpoint status is compliant. If the notification delay period is set to 0%, the user is prompted immediately at the beginning of the grace period to remediate the problem. However, the endpoint is granted access until the grace period expires. The default value for this field is 0%. The valid range is from 0 to 95%.
- Step 6** In the **Rule Name** field, enter the name of the policy.
- Note** It is a best practice to configure a posture policy with each requirement as a separate rule in order to avoid unexpected results.
- Step 7** From the **Identity Groups** column, select the desired identity group.  
You can create posture policies based on user or end-point identity groups.
- Step 8** From the **Operating Systems** column, select the operating system.
- Step 9** From the **Compliance Module** column, select the required compliance module:
- **4.x or Later**: Supports antimalware, disk encryption, patch management, and USB conditions.
  - **3.x or Earlier**: Supports antivirus, antispysware, disk encryption, and patch management conditions

- **Any Version**—: supports file, service, registry, application, and compound conditions.

**Step 10** From the **Posture Type** column, select the Stealth Mode.

- **Standard**—Deploys the AnyConnect agent to monitor and enforce Cisco ISE policies that require client interaction.
- **Clientless**—Deploys the AnyConnect agent to monitor and enforce Cisco ISE posture policies without any client interaction.

**Step 11** In **Other Conditions**, you can add one or more dictionary attributes and save them as simple or compound conditions to a dictionary.

**Note** The dictionary simple conditions and compound conditions that you create in the **Posture Policy** window are not displayed while configuring an authorization policy.

**Step 12** Specify the requirements in the **Requirements** field.

**Step 13** Click **Save**.

---

#### Related Topics

[Create Client Posture Requirements](#), on page 782

[Configure Periodic Reassessments](#), on page 765

## Configure AnyConnect Workflow

To configure the AnyConnect agent, perform the following steps in Cisco ISE:

- 
- Step 1** Create an AnyConnect agent profile.
  - Step 2** Create an AnyConnect configuration for AnyConnect packages.
  - Step 3** Create a client provisioning policy.
  - Step 4** (Optional) Create custom posture condition.
  - Step 5** (Optional) Create custom remediation action.
  - Step 6** (Optional) Create custom posture requirements.
  - Step 7** Create a posture policy.
  - Step 8** Configure the client provisioning policy.
  - Step 9** Create an authorization profile.
  - Step 10** Configure the authorization policies.
  - Step 11** Download and launch AnyConnect.
    - a) Connect to the SSID.
    - b) Launch a Browser and you will be redirected to the Client Provisioning Portal.
    - c) Click **Start**. This checks if the AnyConnect agent is installed and running.
    - d) Click **This Is My First Time Here**.
    - e) Choose **Click Here to Download and Launch AnyConnect**.

- f) Save the Cisco Anyconnect .exe or .dmg file for Windows or macOS respectively. For Windows, run the .exe file and for macOS, double-click the .dmg file and run the app.



**Note** Cisco ISE does not support ARM64 version of AnyConnect for AnyConnect posture flow. Ensure that you do not use the ARM64 version of AnyConnect in the client provisioning policy, otherwise it might cause failure on the client side. Restart the client if AnyConnect is not working properly because of this issue.

## Posture Assessment Options

The following table provides a list of posture assessment (posture conditions) options that are supported by the Cisco ISE Posture Agents for Windows and Macintosh, and the Web Agent for Windows.

*Table 66: Posture Assessment Options*

ISE Posture Agent for Windows	Cisco Temporal Agent for Windows	ISE Posture Agent for Macintosh OS X	Cisco Temporal Agent for Macintosh OS X
Operating System/Service Packs/Hotfixes	—	—	—
Service Check	Service Check (Temporal agent 4.5 and ISE 2.3)	Service Check (AC 4.1 and ISE 1.4)	Daemon checks are not supported
Registry Check	Registry Check (Temporal agent 4.5 and ISE 2.3)	—	—
File Check	File Check (Temporal agent 4.5 and ISE 2.3)	File Check (AC 4.1 and ISE 1.4)	File Check (Temporal agent 4.5 and ISE 2.3)
Application Check	Application Check (Temporal agent 4.5 and ISE 2.3)	Application Check (AC 4.1 and ISE 1.4)	Application Check (Temporal agent 4.5 and ISE 2.3)
Antivirus Installation	Antimalware Installation	Antivirus Installation	Antimalware Installation
Antivirus Version/ Antivirus Definition Date	OPSWAT version 4 is used, hence no Antivirus/Antispyware support; only Antimalware is supported	Antivirus Version/ Antivirus Definition Date	OPSWAT version 4 is used, hence no Antivirus/Antispyware support; only Antimalware is supported
Antispyware Installation	OPSWAT version 4 is used, hence no Antivirus/Antispyware support; only Antimalware is supported	Antispyware Installation	OPSWAT version 4 is used, hence no Antivirus/Antispyware support; only Antimalware is supported

ISE Posture Agent for Windows	Cisco Temporal Agent for Windows	ISE Posture Agent for Macintosh OS X	Cisco Temporal Agent for Macintosh OS X
Antispyware Version/ Antispyware Definition Date	OPSWAT version 4 is used, hence no Antivirus/Antispyware support; only Antimalware is supported	Antispyware Version/ Antispyware Definition Date	OPSWAT version 4 is used, hence no Antivirus/Antispyware support; only Antimalware is supported
Patch Management Check (AC 4.1 and ISE 1.4)	Only Patch Management installation check	Patch Management Check (AC 4.1 and ISE 1.4)	—
Windows Update Running	—	—	—
Windows Update Configuration	—	—	—
WSUS Compliance Settings	—	—	—

## Posture Remediation Options

The following table provides a list of posture remediation options that are supported by the Cisco ISE Posture Agents for Windows and Macintosh, and the Web Agent for Windows.

*Table 67: Posture Remediation Options*

ISE Posture Agent for Windows	ISE Posture Agent for Macintosh OS X
Message Text (Local Check)	Message Text (Local Check)
URL Link (Link Distribution)	URL Link (Link Distribution)
File Distribution	—
Launch Program	—
Antivirus Definition Update	Antivirus Live Update
Antispyware Definition Update	Antispyware Live Update
Patch Management Remediation (AC 4.1 - and ISE 1.4)	—
Windows Update	—
WSUS	—

**ISE Community Resource**  
[Cisco ISE and SCCM integration Reference Guide](#)

## Custom Conditions for Posture

A posture condition can be any one of the following simple conditions: a file, a registry, an application, a service, or a dictionary condition. One or more conditions from these simple conditions form a compound condition, which can be associated with a posture requirement.

After an initial posture update, Cisco ISE also creates Cisco-defined simple and compound conditions. Cisco-defined simple conditions use the `pc_as` and compound conditions use `pr_as`.

A user-defined condition or a Cisco-defined condition includes both simple and compound conditions.

Posture service makes use of internal checks based on antivirus and antispyware (AV/AS) compound conditions. Hence, posture reports do not reflect the exact AV/AS compound-condition names that you have created. The reports display only the internal check names of AV/AS compound conditions.

For example, if you have created an AV compound condition named "MyCondition\_AV\_Check" to check any Vendor and any Product, the posture reports will display the internal check, that is "av\_def\_ANY", as the condition name, instead of "MyCondition\_AV\_Check".

## Custom Posture Remediation Actions

A custom posture remediation action is a file, a link, an antivirus or antispyware definition updates, launching programs, Windows updates, or Windows Server Update Services (WSUS) remediation types.

### Related Topics

[Add a File Remediation](#), on page 777

[Add a Link Remediation](#), on page 778

[Add an Antivirus Remediation](#), on page 778

[Add an Antispyware Remediation](#), on page 779

[Add a Launch Program Remediation](#), on page 779

[Add a Windows Update Remediation](#), on page 780

[Add a Windows Server Update Services Remediation](#), on page 780

[Add a Patch Management Remediation](#), on page 778

## Add a File Remediation

A file remediation allows clients to download the required file version for compliance. The client agent remediates an endpoint with a file that is required by the client for compliance.

You can filter, view, add, or delete file remediations in the File Remediations window, but you cannot edit file remediations. The File Remediations window displays all the file remediations along with their name and description and the files that are required for remediation.

- 
- Step 1** Choose **Policy** > **Policy Elements** > **Results** > **Posture** .
  - Step 2** Click **Remediation Actions**.
  - Step 3** Click **File Remediation**.
  - Step 4** Click **Add**.

- Step 5** Enter the name and description of the file remediation in the **Name** and **Description** fields.
  - Step 6** Modify the values in the **New File Remediation** window.
  - Step 7** Click **Submit**.
- 

## Add a Link Remediation

A link remediation allows clients to click a URL to access a remediation window or resource. The client agent opens a browser with the link and allow the clients to remediate themselves for compliance.

The Link Remediation window displays all the link remediations along with their name and description and their modes of remediation.

---

- Step 1** Choose **Policy > Policy Elements > Results > Posture**.
  - Step 2** Click **Remediation Actions**.
  - Step 3** Click **Link Remediation**.
  - Step 4** Click **Add**.
  - Step 5** Modify the values in the **New Link Remediation** window.
  - Step 6** Click **Submit**.
- 

## Add a Patch Management Remediation

You can create a patch management remediation, which updates clients with up-to-date file definitions for compliance after remediation.

The Patch Management Remediation window displays the remediation type, patch management vendor names, and various remediation options.

---

- Step 1** Choose **Policy > Policy Elements > Results > Posture**.
  - Step 2** Click **Remediation Actions**.
  - Step 3** Click **Patch Management Remediation**.
  - Step 4** Click **Add**.
  - Step 5** Modify the values in the **Patch Management Remediation** window.
  - Step 6** Click **Submit** to add the remediation action to the **Patch Management Remediations** window.
- 

## Add an Antivirus Remediation

You can create an antivirus remediation, which updates clients with up-to-date file definitions for compliance after remediation.

The AV Remediations window displays all the antivirus remediations along with their name and description and their modes of remediation.

- 
- Step 1** Choose **Policy > Policy Elements > Results > Posture**.
  - Step 2** Click **Remediation Actions**.
  - Step 3** Click **AV Remediation**.
  - Step 4** Click **Add**.
  - Step 5** Modify the values in the **New AV Remediation** window.
  - Step 6** Click **Submit**.
- 

## Add an Antispyware Remediation

You can create an antispyware remediation, which updates clients with up-to-date file definitions for compliance after remediation.

The AS Remediations window displays all the antivirus remediations along with their name and description and their modes of remediation.

- 
- Step 1** Choose **Policy > Policy Elements > Results > Posture**.
  - Step 2** Click **Remediation Actions**.
  - Step 3** Click **AS Remediation**.
  - Step 4** Click **Add**.
  - Step 5** Modify the values in the **New AS Remediations** window.
  - Step 6** Click **Submit**.
- 

## Add a Launch Program Remediation

You can create a launch program remediation, where the client agent remediates clients by launching one or more applications for compliance.

The Launch Program Remediations page displays all the launch program remediations along with their name and description and their modes of remediation.

- 
- Step 1** Choose **Policy > Policy Elements > Results > Posture**.
  - Step 2** Click **Remediation Actions**.
  - Step 3** Click **Launch Program Remediation**.
  - Step 4** Click **Add**.
  - Step 5** Modify the values in the **New Launch Program Remediation** page.
  - Step 6** Click **Submit**.
-

## Troubleshoot Launch Program Remediation

### Problem

When an application is launched as a remediation using Launch Program Remediation, the application is successfully launched (observed in the Windows Task Manager), however, the application UI is not visible.

### Solution

The Launch program UI application runs with system privileges, and is visible in the Interactive Service Detection (ISD) window. To view the Launch program UI application, ISD should be enabled for the following OS:

- Windows Vista: ISD is in stop state by default. Enable ISD by starting ISD service in services.msc.
- Windows 7: ISD service is enabled by default.
- Windows 8/8.1: Enable ISD by changing "NoInteractiveServices" from 1 to 0 in the registry: `\HKEY_LOCAL_MACHINE\SYSTEM\CurrentControlSet\Control\Windows`.

## Add a Windows Update Remediation

The Windows Update Remediations page displays all the Windows update remediations along with their name and description and their modes of remediation.

- 
- Step 1** Choose **Policy > Policy Elements > Results > Posture**.
  - Step 2** Click **Remediation Actions**.
  - Step 3** Click **Windows Update Remediation**.
  - Step 4** Click **Add**.
  - Step 5** Modify the values in the **New Windows Update Remediation** window.
  - Step 6** Click **Submit**.
- 

## Add a Windows Server Update Services Remediation

You can configure Windows clients to receive the latest WSUS updates from a locally administered or a Microsoft-managed WSUS server for compliance. A Windows Server Update Services (WSUS) remediation installs latest Windows service packs, hotfixes, and patches from a locally managed WSUS server or a Microsoft-managed WSUS server.

You can create a WSUS remediation where the client agent integrates with the local WSUS Agent to check whether the endpoint is up-to-date for WSUS updates.

- 
- Step 1** Choose **Policy > Policy Elements > Results > Posture**.
  - Step 2** Click **Remediation Actions**.
  - Step 3** Click **Windows Server Update Services Remediation**.
  - Step 4** Click **Add**.



- Step 5** Modify the values in the **New Windows Server Update Services Remediation** window.
- Step 6** Click **Submit**.

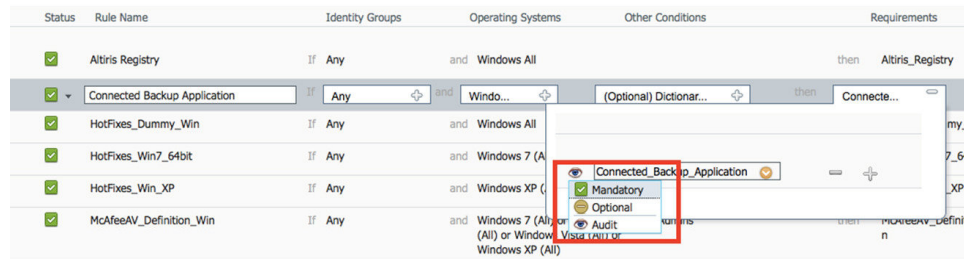
## Posture Assessment Requirements

A posture requirement is a set of compound conditions with an associated remediation action that can be linked with a role and an operating system. All the clients connecting to your network must meet mandatory requirements during posture evaluation to become compliant on the network.

Posture-policy requirements can be set to mandatory, optional, or audit types in posture policies. If requirements are optional and clients fail these requirements, then the clients have an option to continue during posture evaluation of endpoints.

Posture checks are evaluated in the order of mandatory, optional, and audit. If a mandatory check fails, the related audit checks will not be carried out.

**Figure 57: Posture Policy Requirement Types**



### Mandatory Requirements

During policy evaluation, the agent provides remediation options to clients who fail to meet the mandatory requirements defined in the posture policy. End users must remediate to meet the requirements within the time specified in the remediation timer settings.

For example, you have specified a mandatory requirement with a user-defined condition to check the existence of C:\temp\text.file in the absolute path. If the file does not exist, the mandatory requirement fails and the user will be moved to Non-Compliant state.

### Optional Requirements

During policy evaluation, the agent provides an option to clients to continue, when they fail to meet the optional requirements specified in the posture policy. End users are allowed to skip the specified optional requirements.

For example, you have specified an optional requirement with a user-defined condition to check for an application running on the client machine, such as Calc.exe. Although, the client fails to meet the condition, the agent prompts an option to continue further so that the optional requirement is skipped and the end user is moved to Compliant state.

### Audit Requirements

Audit requirements are specified for internal purposes and the agent does not prompt any message or input from end users, regardless of the pass or fail status during policy evaluation.

For example, you are in the process of creating a mandatory policy condition to check if end users have the latest version of the antivirus program. If you want to find out the non-compliant end users before actually enforcing it as a policy condition, you can specify it as an audit requirement.

### Visibility Requirements

During policy evaluation, the agent reports compliance data for visibility requirements, every five to ten minutes.

### Related Topics

[Stealth Mode Deployment](#), on page 785

[Impact of Stealth Mode on Posture Policy and Requirement Types](#), on page 786

[Configure AnyConnect Clientless Mode Workflow](#), on page 788

## Client System Stuck in Noncompliant State

If a client machine is unable to remediate a mandatory requirement, the posture status changes to “noncompliant” and the agent session is quarantined. To get the client machine past this “noncompliant” state, you need to restart the posture session so that the agent starts posture assessment on the client machine again. You can restart the posture session as follows:

- In wired and wireless Change of Authorization (CoA) in an 802.1X environment:
  - You can configure the Reauthentication timer for a specific authorization policy when you create a new authorization profile in the New Authorization Profiles window.
  - Wired users can get out of the quarantine state once they disconnect and reconnect to the network. In a wireless environment, the user must disconnect from the wireless lan controller (WLC) and wait until the user idle timeout period has expired before attempting to reconnect to the network.
- In a VPN environment—Disconnect and reconnect the VPN tunnel.

## Create Client Posture Requirements

You can create a requirement in the Requirements window where you can associate user-defined conditions and Cisco defined conditions, and remediation actions. Once created and saved in the Requirements window, user-defined conditions and remediation actions can be viewed from their respective list windows.



**Note** To create a Posture Requirement to validate all Windows 10 hotfixes in the environment, you must configure the Conditions area of your Requirement to include both pr\_Win10\_32\_Hotfixes and pr\_Win10\_64\_Hotfixes. At the top of the conditions, ensure **All selected conditions succeed** is selected. If the configuration is successful, **pr\_Win10\_32\_Hotfixes & pr\_Win10\_64\_Hotfixes** will be displayed. To view the details of the validated conditions for an endpoint, from the main menu, choose **Operations > Reports > Reports > Endpoints and Users > Posture Assessment by Endpoints**. Click the endpoint to view the corresponding posture details.

*Figure 58: Validating Posture Requirements in Windows 10*

Name	Operating System	Compliance Module	Posture Type	Conditions	Remediations Actions
Any_AV_Installation_Win	for Windows All	using 3.x or earlier	using AnyConnect	met If ANY_av_win_inst	then Message Text Only
hotfix test	for Windows ...	using 4.x or later	using AnyConnect	met If Select C...	X then Select Re...
Any_AV_Definition_Win	for Windows All	using 3.x or earlier	using AnyConnect	met If ANY_av_...	All selected conditions succeed
Any_AS_Installation_Win	for Windows All	using 3.x or earlier	using AnyConnect	met If ANY_as_...	pr_Win10_32_Hotfixes
Any_AS_Definition_Win	for Windows All	using 3.x or earlier	using AnyConnect	met If ANY_as_...	pr_Win10_64_Hotfixes
Any_AV_Installation_Mac	for Mac OSX	using 3.x or earlier	using AnyConnect	met If ANY_av_f...	
Any_AV_Definition_Mac	for Mac OSX	using 3.x or earlier	using AnyConnect	met If ANY_av_mac_def	then AnyAVDefRemediationMac
Any_AS_Installation_Mac	for Mac OSX	using 3.x or earlier	using AnyConnect	met If ANY_as_mac_inst	then Message Text Only
Any_AS_Definition_Mac	for Mac OSX	using 3.x or earlier	using AnyConnect	met If ANY_as_mac_def	then AnyASDefRemediationMac
Any_AM_Installation_Win	for Windows All	using 4.x or later	using AnyConnect	met If ANY_am_win_inst	then Message Text Only
Any_AM_Definition_Win	for Windows All	using 4.x or later	using AnyConnect	met If ANY_am_win_def	then AnyAMDDefRemediationWin
Any_AM_Installation_Mac	for Mac OSX	using 4.x or later	using AnyConnect	met If ANY_am_mac_inst	then Message Text Only

**Before you begin**

- You must have an understanding of acceptable use policies (AUPs) for a posture.

- Step 1** Choose **Policy > Policy Elements > Results > Posture > Requirements**.
- Step 2** Enter the values in the **Requirements** window.
- Step 3** Click **Done** to save the posture requirement in read-only mode.
- Step 4** Click **Save**.

**Related Topics**

- [Client System Stuck in Noncompliant State](#), on page 782
- [Posture Assessment Requirements](#), on page 781

# Custom Permissions for Posture

A custom permission is a standard authorization profile that you define in Cisco ISE. Standard authorization profiles set access privileges based on the matching compliance status of the endpoints. The posture service

broadly classifies the posture into unknown, compliant, and noncompliant profiles. The posture policies and the posture requirements determine the compliance status of the endpoint.

You must create three different authorization profiles for an unknown, compliant, and noncompliant posture status of endpoints that can have different set of VLANs, DACLs, and other attribute value pairs. These profiles can be associated with three different authorization policies. To differentiate these authorization policies, you can use the Session:PostureStatus attribute along with other conditions.

### Unknown Profile

If no matching posture policy is defined for an endpoint, then the posture compliance status of the endpoint may be set to unknown. A posture compliance status of unknown can also apply to an endpoint where a matching posture policy is enabled but posture assessment has not yet occurred for that endpoint and, therefore no compliance report has been provided by the client agent.




---

**Note** We recommend you to use posture with redirection for all Cisco network access devices.

---

### Compliant Profile

If a matching posture policy is defined for an endpoint, then the posture compliance status of the endpoint is set to compliant. When the posture assessment occurs, the endpoint meets all the mandatory requirements that are defined in the matching posture policy. For an endpoint that is postured compliant, it can be granted privileged network access on your network.

### Noncompliant Profile

The posture compliance status of an endpoint is set to noncompliant when a matching posture policy is defined for that endpoint but it fails to meet all the mandatory requirements during posture assessment. An endpoint that is postured noncompliant matches a posture requirement with a remediation action, and it should be granted limited network access to remediation resources in order to remediate itself.

### Related Topics

[Configure Standard Authorization Policies](#), on page 784

## Configure Standard Authorization Policies

You can define two types of authorization policies in the Authorization Policy page, standard exceptions authorization policies. The standard authorization policies that are specific to posture are used to make policy decisions based on the compliance status of endpoints.

**Step 1** Choose **Policy** > **Authorization**.

**Step 2** Choose one of the matching rule type to apply from the drop-down list shown at the top of the Authorization Policy page.

- **First Matched Rule Applies** — This option sets access privileges with a single authorization policy that is first matched during evaluation from the list of standard authorization policies. Once the first matching authorization policy is found, the rest of the standard authorization policies are not evaluated.
- **Multiple Matched Rule Applies** — This option sets access privileges with multiple authorization policies that are matched during evaluation from the list of all the standard authorization policies

- Step 3** Click the down arrow next to **Edit** in the default standard authorization policy row.
- Step 4** Click **Insert New Rule Above**.
- Step 5** Enter a rule name, choose identity groups and other conditions, and associate an authorization profile in the new authorization policy row that appears above the default standard authorization policy row.
- Step 6** Click **Done** to create a new standard authorization policy in read-only mode.
- Step 7** Click **Save**.
- 

## Stealth Mode Deployment

You can deploy the AnyConnect agent in the stealth mode to monitor and enforce Cisco ISE posture policies. It is referred to as stealth mode because it allows posture to be run as a service without any user interaction. Stealth Mode is of two types—Standard and Clientless.

In the standard mode, it deploys the AnyConnect agent to monitor and enforce Cisco ISE posture policies that require client interaction.

In the Clientless mode, it allows posture to be run as a service without any user interaction. The Client Provisioning page (Policy > Policy Elements > Results > Client Provisioning > Resources) and the Posture Requirements page (Policy > Policy Elements > Results > Posture > Requirements) contains the Standard and Clientless modes, and the recommended best practice is to provision the posture profile in the Client Provisioning page.

When you choose Clientless mode in the posture requirement, some of the conditions, remediations, or attributes in a condition are disabled (grayed out). For example, when you enable Clientless Mode requirement, the Manual Remediation Type is disabled (grayed out) because this action requires client-side interaction.

Mapping the posture profile to the AnyConnect configuration, and then mapping the Anyconnect configuration to the Client Provisioning page for clientless mode deployment supports:

- AnyConnect to read the posture profile and set it to the intended mode.
- AnyConnect to send information related to the selected mode to Cisco ISE during initial posture request.
- Cisco ISE to match the right policy, based on the mode and other factors, such as identity group, OS, and compliance module.



---

**Note** AnyConnect version 4.4 and later support Cisco ISE posture in Clientless mode.

---

### Related Topics

[Posture Assessment Requirements](#), on page 781

[Impact of Stealth Mode on Posture Policy and Requirement Types](#), on page 786

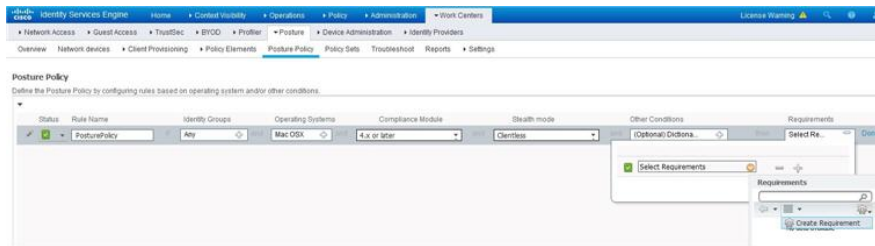
[Best Practices for Network Drive Mapping with Posture](#), on page 788

# Impact of Stealth Mode on Posture Policy and Requirement Types

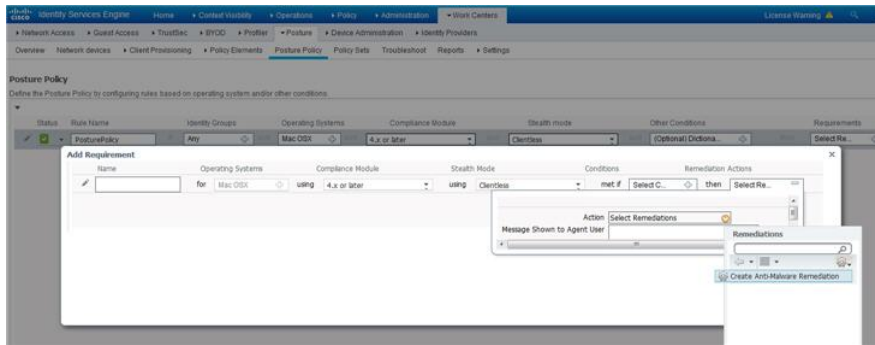
Impact of Stealth Mode in the Work Centers > Posture > Posture Policy page:

- When you select Clientless in the posture policy and create an inline new requirement, the Operating Systems, Compliance Module, and Standard/Clientless Mode appears as Read Only fields.

**Figure 59: Inline Requirement**

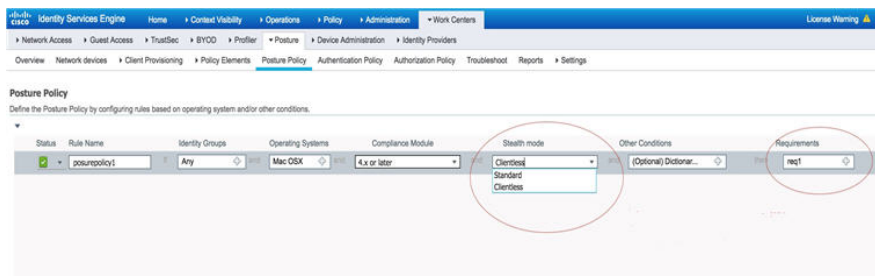


**Figure 60: Read Only Fields—OS, Compliance Module, and Stealth Mode**



- When you change the Stealth Mode selection in the posture policy, it clears the selected Requirement.

**Figure 61: Effect of Stealth Mode on Requirements**



Impact of Stealth Mode in the Work Centers > Posture > Policy Elements > Requirements page:

- When the Stealth Mode is Clientless, the remediation list filters out the remediations that contain the Remediation Type as Manual.
- Supported Remediation Actions are filtered based on the Operating Systems and Stealth Mode selections.

- Remediation Actions are not applicable for Application Conditions configured using the Provision By Category or Provision By Everything options.

Impact of Stealth Mode in the Work Centers > Posture > Policy Elements > Remediations page:

- If you have associated a remediation type with a policy requirement, you will not be able to switch the **Remediation Type** from **Automatic** to **Manual**.
- You cannot switch the **Installation Wizard Interface Setting** from **No UI** to **Show UI**.

**Figure 62: Remediation Type and Installation Wizard Interface Setting**

Windows Server Update Services Remediations List > New Windows Server Update Services Remediation

**Windows Server Update Services Remediation**

\* Name  ⓘ

Description

Compliance Module Any version

Remediation Type 

- Automatic
- Automatic**
- Manual

Interval  (in secs) (Valid Range 0 to 9999)

Retry Count  (Valid Range 0 to 99)

Validate Windows updates using  Cisco Rules  Severity Level

Windows Updates Severity Level

Update to latest OS Service Pack

Windows Updates Installation Source  Microsoft Server  Managed Server

Installation Wizard Interface Setting  Show UI  No UI

You can configure the following remediations in the Stealth Mode:

- Create Anti-Malware Remediation
- Create Launch Program Remediation
- Create Patch Management Remediation
- Create USB Remediation
- Create Windows Server Update Services Remediation
- Create Windows Update Remediation

You cannot configure the following remediations in the Stealth mode:

- Manual Remediation
- Link Remediation
- File Remediation

- Windows Server Update Services (WSUS) Remediation (As seen in Figure: Remediation Type and Installation Wizard Interface Setting)
- Patch Management Remediation—Activate Patch Management Software GUI (Remediation Option)
- AUP Policy

## Best Practices for Network Drive Mapping with Posture

During posture assessment of a Windows endpoint, the endpoint user may encounter a delay in accessing the desktop. This may be due to Windows trying to restore the file server drive letter mappings before providing the user access to the desktop. The best practices to avoid the delay during posture are:

- Endpoints should be able to reach the Active Directory server because the file server drive letter cannot be mapped without reaching the AD. When posture (with AnyConnect ISE posture agent) triggers, it blocks access to AD, causing delay in login. Use Posture Remediation ACLs to provide access to AD servers before posture is completed.
- You should set a delay for the login script until posture completes and then you have to set the Persistence attribute to NO. Windows tries to reconnect all the network drives during login and this cannot be done until AnyConnect ISE posture agent gains full network access.

## Configure AnyConnect Clientless Mode Workflow

The process of configuring AnyConnect in the clientless mode involves a series of steps. You should perform the following steps in Cisco ISE.

- 
- Step 1** Create an AnyConnect agent profile, see [Create an AnyConnect Agent Profile](#).
- Step 2** Create an AnyConnect configuration for AnyConnect packages, see [Create an AnyConnect Configuration for AnyConnect Packages](#).
- Step 3** Upload a Open DNS Profile in Cisco ISE, see [Upload a Open DNS Profile in Cisco ISE](#).
- Step 4** Create a Client Provisioning Policy, see [Create a Client Provisioning Policy](#).
- Step 5** Create a Posture Condition, see [Create a Posture Condition](#).
- Step 6** Create Posture Remediation, see [Create Posture Remediation](#)
- Step 7** Create Posture Requirement in Clientless Mode, see [Create Posture Requirement in Clientless Mode](#).
- Step 8** Create Posture Policy, see [Create Posture Policy](#).
- Step 9** Configure authorization profile.
- Choose **Policy > Policy Elements > Results > Authorization > Authorization Profiles**.
  - Click **Add** and enter the **Name** of the profile.
  - In Common Tasks, enable **Web Redirection (CWA, MDM, NSP, CPP)** and choose **Client provisioning (Posture)** from the drop-down list, enter the redirect **ACL** name and choose the Client Provisioning Portal **Value**. You can edit or create a new Client Provisioning Portal in **Work Centers > Posture > Client Provisioning > Client Provisioning Portal**.
- Step 10** Configure authorization policies.
- Choose **Policy > Policy Sets**.



- b) Click > and choose **Authorization Policy** and click on + icon to create a new authorization rule that features **Session:Posture Status EQUALS Unknown** condition and the authorization profile configured previously.
  - c) Above the previous rule, create a new authorization rule that features **Session:Posture Status EQUALS NonCompliant** condition and another one that features **Session:Posture Status EQUALS Compliant** condition.
- 

## Create an AnyConnect Agent Profile

### Before you begin

You must upload the AnyConnect packages for MAC and Windows OS and the AnyConnect compliance modules.

---

- Step 1** Choose **Policy > Policy Elements > Results > Client Provisioning > Resources** page.
  - Step 2** From the **Add** drop-down list, choose **Nac Agent or AnyConnect Posture Profile**.
  - Step 3** From the **Posture Agent Profile Settings** drop-down list, choose **AnyConnect**.
  - Step 4** In the **Name** field, type the required name (for example, AC\_Agent\_Profile).
  - Step 5** In the **Agent Behavior** section, select the **Stealth Mode** parameter as **Clientless**.
  - Step 6** Click **Save**.
- 

### What to do next

You should create the AnyConnect configuration for the AnyConnect packages.

## Create an AnyConnect Configuration for AnyConnect Packages

- Step 1** Choose **Policy > Policy Elements > Results > Client Provisioning > Resources** page.
  - Step 2** From the **Add** drop-down list, choose **AnyConnect Configuration**.
  - Step 3** From the **Select AnyConnect Package** drop-down list, choose the required AnyConnect package.
  - Step 4** In the **Configuration Name** text box, type the required Name.
  - Step 5** In the **Compliance Module** drop-down list, choose the required compliance module.
  - Step 6** In the **AnyConnect Module Selection** section, check the **ISE Posture** and **Network Access Manager** check boxes.
  - Step 7** In the **Profile Selection** section, from the **ISE Posture** drop-down list, choose the AnyConnect agent profile.
  - Step 8** From the **Network Access Manager** drop-down list, choose the required AnyConnect agent profile.
- 

### What to do next

You should upload the Open DNS profile to be pushed to the client.

## Upload a Open DNS Profile in Cisco ISE

The Open DNS profile is pushed to the client.

- 
- Step 1** Navigate to the **Policy > Policy Elements > Results > Client Provisioning > Resources** page.
  - Step 2** From the **Add** drop-down list, choose **Agent Resources From Local Disk**.
  - Step 3** From the **Category** drop-down list, choose **Customer Created Packages**.
  - Step 4** From the **Type** drop-down list, choose **AnyConnect Profile**.
  - Step 5** In the **Name** text box, type the required name (for example, OpenDNS).
  - Step 6** Click **Browse** and locate the JSON file from the local disk.
  - Step 7** Click **Submit**.
- 

### What to do next

You should create the client provisioning policy.

## Create a Client Provisioning Policy

- 
- Step 1** Navigate to the **Policy > Client Provisioning** page.
  - Step 2** Create the required rule (for example, Rule Name=WindowsAll, if Identity Groups=Any and Operating Systems=Windows All and Other Conditions=Conditions, then Results=AC\_Win\_44117).
- 

### What to do next

You should create the posture condition.

## Create a Posture Condition

- 
- Step 1** Navigate to the **Policy > Policy Elements > Conditions > Posture > File Condition**.
  - Step 2** Enter the required name (for example, filechk).
  - Step 3** From the **Operating Systems** drop-down list, choose Windows 7 (All).
  - Step 4** From the **File Type** drop-down list, choose FileExistence.
  - Step 5** From the **File Path** drop-down list, choose ABSOLUTE\_PATH C:\test.txt.
  - Step 6** From the **File Operator** drop-down list, choose DoesNotExist.
- 

### What to do next

You should create the posture remediation.

## Create Posture Remediation

The file condition checks if test.txt file exists on the endpoint. If it does not exist, the remediation is to block the USB port and prevent the installation of the file using a USB device.

- 
- Step 1** Navigate to the **Policy > Policy Elements > Results > Remediation Actions > USB Remediations** page.
  - Step 2** Enter the required name (for example, clientless\_mode\_block).
  - Step 3** Click **Submit**.
- 

### What to do next

You should create the posture requirement.

## Create Posture Requirement in Clientless Mode

When you create a Remediation action from the Requirements page, only the remediations that are applicable to Clientless mode are displayed: Anti-Malware, Launch Program, Patch Management, USB, Windows Server Update Services, and Windows Update.

- 
- Step 1** Navigate to the **Policy > Policy Elements > Results > Client Provisioning > Resources** page.
  - Step 2** Create the required posture requirement (for example, Name=win7Req for Operating Systems=Windows7(All) using Compliance Module=4.x or later using Stealth Mode=Clientless met if Condition=filechk then Remediation Actions=clientless\_mode\_block).
- 

### What to do next

You should create the posture policy.

## Create Posture Policy

### Before you begin

Ensure that the posture policy requirement and the policy are created in the clientless mode.

- 
- Step 1** Choose **Policy > Posture**.
  - Step 2** Create the required rule. For example, if Identity Groups=Any and Operating Systems=Windows 7(All) and Compliance Module=4.x or later and Stealth Mode=Clientless then Requirements=win7Req.

**Note** For Client Provisioning without URL redirection, configuring the conditions with attributes specific to Network Access or Radius will not work and matching of the client provisioning policy might fail due to the non-availability of session information for the specific user in the Cisco ISE server. However, Cisco ISE allows configuring conditions for the externally added identity groups.

---



## CHAPTER 27

# Cisco TrustSec Policies Configuration

---

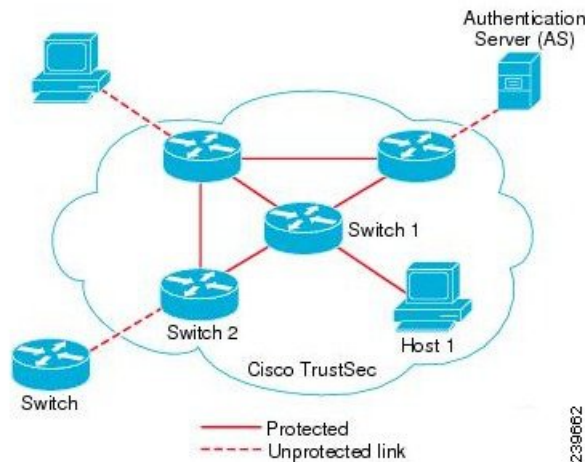
- [TrustSec Architecture](#), on page 793
- [TrustSec Dashboard](#), on page 796
- [Configure TrustSec Global Settings](#), on page 799
- [Configure TrustSec Matrix Settings](#), on page 800
- [Configure TrustSec Devices](#), on page 800
- [Configure Cisco TrustSec AAA Servers](#), on page 802
- [Security Groups Configuration](#), on page 802
- [Egress Policy](#), on page 809
- [SGT Assignment](#), on page 823
- [TrustSec Configuration and Policy Push](#), on page 825
- [Security Group Tag Exchange Protocol](#), on page 833
- [Add an SXP Domain Filter](#), on page 834
- [Configure SXP Settings](#), on page 835
- [TrustSec-Cisco ACI Integration](#), on page 835
- [Configure Cisco ACI Settings](#), on page 836
- [Run Top N RBACL Drops by User Report](#), on page 838

## TrustSec Architecture

The Cisco TrustSec solution establishes clouds of trusted network devices to build secure networks. Each device in the Cisco TrustSec cloud is authenticated by its neighbors (peers). Communication between the devices in the TrustSec cloud is secured with a combination of encryption, message integrity checks, and data-path replay protection mechanisms. The TrustSec solution uses the device and user identity information that it obtains during authentication to classify, or color, the packets as they enter the network. This packet classification is maintained by tagging packets when they enter the TrustSec network so that they can be properly identified for the purpose of applying security and other policy criteria along the data path. The tag, also called the security group tag (SGT), allows Cisco ISE to enforce access control policies by enabling the endpoint device to act upon the SGT to filter traffic.

The following figure shows an example of a TrustSec network cloud.

Figure 63: TrustSec Architecture



#### ISE Community Resource

For information on how to simplify network segmentation and improve security using Cisco TrustSec, see [Simplify Network Segmentation with Cisco TrustSec](#) and [Policy-Based Software Defined Segmentation and Cisco TrustSec Improve Security White Paper](#).

For a complete list of Cisco TrustSec platform support matrices, see [Cisco TrustSec Platform Support Matrix](#).

For a complete list of support documentation available for TrustSec, see [Cisco TrustSec](#).

For a complete list of TrustSec community resources, see [TrustSec Community](#).

## TrustSec Components

The key TrustSec components include:

- Network Device Admission Control (NDAC)—In a trusted network, during authentication, each network device (for example Ethernet switch) in a TrustSec cloud is verified for its credential and trustworthiness by its peer device. NDAC uses the IEEE 802.1X port-based authentication and uses Extensible Authentication Protocol-Flexible Authentication via Secure Tunneling (EAP-FAST) as its Extensible Authentication Protocol (EAP) method. Successful authentication and authorization in the NDAC process results in Security Association Protocol negotiation for IEEE 802.1AE encryption. Cisco ISE has CTS Provisioning (EAP-FAST) TLSv1.2 support for switching platforms starting IOSXE 17.1, and for routing platforms starting IOSXE 17.6.
- Endpoint Admission Control (EAC)—An authentication process for an endpoint user or a device connecting to the TrustSec cloud. EAC typically happens at the access level switch. Successful authentication and authorization in EAC process results in SGT assignment to the user or device. EAC access methods for authentication and authorization includes:
  - 802.1X port-based authentication
  - MAC authentication bypass (MAB)
  - Web authentication (WebAuth)

- Security Group (SG)—A grouping of users, endpoint devices, and resources that share access control policies. SGs are defined by the administrator in Cisco ISE. As new users and devices are added to the TrustSec domain, Cisco ISE assigns these new entities to the appropriate security groups.
- Security Group Tag (SGT)—TrustSec service assigns to each security group a unique 16-bit security group number whose scope is global within a TrustSec domain. The number of security groups in the switch is limited to the number of authenticated network entities. You do not have to manually configure security group numbers. They are automatically generated, but you have the option to reserve a range of SGTs for IP-to-SGT mapping.
- Security Group Access Control List (SGACL)—SGACLs allow you to control the access and permissions based on the SGTs that are assigned. The grouping of permissions into a role simplifies the management of security policy. As you add devices, you simply assign one or more security groups, and they immediately receive the appropriate permissions. You can modify the security groups to introduce new privileges or restrict current permissions.
- Security Exchange Protocol (SXP)—SGT Exchange Protocol (SXP) is a protocol developed for TrustSec service to propagate the IP-SGT bindings across network devices that do not have SGT-capable hardware support to hardware that supports SGT/SGACL.
- Environment Data Download—The TrustSec device obtains its environment data from Cisco ISE when it first joins a trusted network. You can also manually configure some of the data on the device. The device must refresh the environment data before it expires. The TrustSec device obtains the following environment data from Cisco ISE:
  - Server lists—List of servers that the client can use for future RADIUS requests (for both authentication and authorization)
  - Device SG—Security group to which the device itself belongs
  - Expiry timeout—Interval that controls how often the TrustSec device should download or refresh its environment data
- Identity-to-Port Mapping—A method for a switch to define the identity on a port to which an endpoint is connected, and to use this identity to look up a particular SGT value in the Cisco ISE server.

## TrustSec Terminology

The following table lists some of the common terms that are used in the TrustSec solution and their meaning in an TrustSec environment.

**Table 68: TrustSec Terminology**

Term	Meaning
Supplicant	A device that tries to join a trusted network.
Authentication	The process of verifying the identity of each device before allowing it to be part of the trusted network.
Authorization	The process of deciding the level of access to a device that requests access to a resource on a trusted network based on the authenticated identity of the device.

Term	Meaning
Access control	The process of applying access control on a per-packet basis based on the SGT that is assigned to each packet.
Secure communication	The process of encryption, integrity, and data-path replay protection for securing the packets that flow over each link in a trusted network.
TrustSec device	Any of the Cisco Catalyst 6000 Series or Cisco Nexus 7000 Series switches that support the TrustSec solution.
TrustSec-capable device	A TrustSec-capable device will have TrustSec-capable hardware and software. For example, the Nexus 7000 Series Switches with the Nexus operating system.
TrustSec seed device	The TrustSec device that authenticates directly against the Cisco ISE server. It acts as both the authenticator and supplicant.
Ingress	When packets first encounter a TrustSec-capable device that is part of a network where the Cisco TrustSec solution is enabled, they are tagged with an SGT. This point of entry into the trusted network is called the ingress.
Egress	When packets pass the last TrustSec-capable device that is part of a network where the Cisco TrustSec solution is enabled, they are untagged. This point of exit from the trusted network is called the egress.

## Supported Switches and Required Components for TrustSec

To set up a Cisco ISE network that is enabled with the Cisco TrustSec solution, you need switches that support the TrustSec solution and other components. Apart from the switches, you also need other components for identity-based user access control using the IEEE 802.1X protocol. For a complete up-to-date list of the TrustSec-supported Cisco switch platforms and the required components, see [Cisco TrustSec-Enabled Infrastructure](#).

## TrustSec Dashboard

The TrustSec dashboard is a centralized monitoring tool for the TrustSec network.

The TrustSec dashboard contains the following dashlets:

- **Metrics:** The Metrics dashlet displays statistics about the behavior of the TrustSec network.
- **Active SGT Sessions:** The Active SGT Sessions dashlet displays the SGT sessions that are currently active in the network. The Alarms dashlet displays alarms that are related to the TrustSec sessions.
- **Alarms**



- **NAD / SGT Quick View:** The Quick View dashlet displays TrustSec-related information for NADs and SGTs.
- **TrustSec Sessions / NAD Activity Live Log:** In the Live Log dashlet, click the TrustSec Sessions link to view the active TrustSec sessions. You can also view information about TrustSec protocol data requests and responses from NADs to Cisco ISE.

## Metrics

This section displays statistics about the behavior of the TrustSec network. You can select the time frame (for example, past 2 hours, past 2 days, and so on) and the chart type (for example, bars, line, spline).

The latest bar values are displayed on the graphs. It also displays the percentage change from the previous bar. If there is an increase in the bar value, it will be displayed in green with a plus sign. If there is a decrease in the value, it will be displayed in red with a minus sign.

Place your cursor on a bar of a graph to view the time at which the value was calculated and its exact value in the following format: <Value:xxxx Date/Time: xxx>

You can view the following metrics:

SGT sessions	Displays the total number of SGT sessions created during the chosen time frame.  <b>Note</b> SGT sessions are the user sessions that received an SGT as part of the authorization flow.
SGTs in use	Displays the total number of unique SGTs that were used during the chosen time frame. For example, in one hour, if there were 200 TrustSec sessions, but ISE responded with only 6 types of SGTs in the authorization responses, the graph will display a value 6 for this hour.
Alarms	Displays the total number of alarms and errors that occurred during the chosen time frame. Errors are displayed in red and alarms are displayed in yellow.
NADs in use	Displays the number of unique NADs, which took part in TrustSec authentications during the chosen time frame.

## Current Network Status

The middle section of the dashboard displays information about the current status of the TrustSec network. The values displayed in the graphs are updated when the page is loaded and can be refreshed by using the Refresh Dashboard option.

## Active SGT Sessions

This dashlet displays the SGT sessions that are currently active in the network. You can view the top 10 most used or least used SGTs. The X-axis shows the SGT usage and the Y-axis displays the names of the SGTs.

To view the TrustSec session details for an SGT, click on the bar corresponding to that SGT. The details of the TrustSec sessions related to that SGT are displayed in the Live Log dashlet.

## Alarms

This dashlet displays the alarms related to the TrustSec sessions. You can view the following details:

- **Alarm Severity**—Displays an icon that represents the severity level of the alarm.
  - **High**—Includes the alarms that indicate failure in the TrustSec network (for example, device failed to refresh its PAC). Marked with red icon.
  - **Medium**—Includes warnings that indicate wrong configuration of the network device (for example, device failed to accept CoA message). Marked with yellow.
  - **Low**—Includes general information and update on network behavior (for example, configuration changes in TrustSec). Marked with blue.
- Alarm description
- Number of times the alarm occurred since this alarm counter was last reset.
- Alarm last occurrence time

## Quick View

The Quick View dashlet displays TrustSec-related information for NADs. You can also view the TrustSec-related information for an SGT.

### NAD Quick View

Enter the name of the TrustSec network device for which you want to view the details in the Search box and press **Enter**. The search box provides an autocomplete feature, which filters and shows the matched device names in a drop-down as the user types into the text box.

The following information is displayed in this dashlet:

- **NDGs**: Lists the Network Device Groups (NDGs) to which this network device belongs.
- **IP Address**: Displays the IP address of the network device. Click on this link to view the NAD activity details in the Live Logs dashlet.
- **Active sessions**: Lists the number of active TrustSec sessions connected to this device.
- **PAC expiry**: Displays the PAC expiry date.
- **Last Policy Refresh**: Displays the policy last download date.
- **Last Authentication**: Displays the last authentication report timestamp for this device.
- **Active SGTs**: Lists the SGTs used in the active sessions that are related to this network device. The number displayed within the brackets denotes the number of sessions that are currently using this SGT. Click on an SGT link to view the TrustSec session details in the Live Log dashlet.

You can use the Show Latest Logs option to view the NAD activity live logs for the device.

### SGT Quick View

Enter the name of the SGT for which you want to view the details in the Search box and press **Enter**.

The following information is displayed in this dashlet:

- **Value:** Displays the SGT value (both decimal and hexadecimal).
- **Icon:** Displays the icon that is assigned to this SGT.
- **Active sessions:** Lists the number of active sessions that are currently using this SGT.
- **Unique users:** Lists the number of unique usernames, which hold this SGT in their active sessions.
- **Updated NADs:** Lists the number of NADs which downloaded policies for this SGT.

## Live Log

Click the link to view the active TrustSec sessions (sessions that have SGT as part of their response).

Click the **NAD Activity** link to view information regarding TrustSec protocol data requests and responses from NADs to Cisco ISE.

Click the **ACI endpoint Activity** link to view the IP-SGT information learnt by Cisco ISE from Cisco ACI.

## Configure TrustSec Global Settings

For Cisco ISE to function as an TrustSec server and provide TrustSec services, you must define some global TrustSec settings.

### Before you begin

- Before you configure global TrustSec settings, ensure that you have defined global EAP-FAST settings (choose **Administration > System > Settings > Protocols > EAP-FAST > EAP-FAST Settings**).

You may change the Authority Identity Info Description to your Cisco ISE server name. This description is a user-friendly string that describes the Cisco ISE server that sends credentials to an endpoint client. The client in a Cisco TrustSec architecture can be either the endpoint running EAP-FAST as its EAP method for IEEE 802.1X authentication or the supplicant network device performing Network Device Access Control (NDAC). The client can discover this string in the protected access credentials (PAC) type-length-value (TLV) information. The default value is Identity Services Engine. You should change the value so that the Cisco ISE PAC information can be uniquely identified on network devices upon NDAC authentication.

- To perform the following task, you must be a Super Admin or System Admin.

---

**Step 1** Choose **Work Centers > TrustSec > Settings > General TrustSec Settings**.

**Step 2** Enter the values in the fields. For information about the fields, see [General TrustSec Settings, on page 990](#)

**Step 3** Click **Save**.

---

### What to do next

- [Configure TrustSec Devices, on page 800](#)

# Configure TrustSec Matrix Settings

## Before you begin

To perform the following task, you must be a Super Admin or System Admin.

- 
- Step 1** Choose **Work Centers > TrustSec > Settings > TrustSec Matrix Settings**.
  - Step 2** Enter the required details in the TrustSec Matrix Settings page.
  - Step 3** Click **Save**.
- 

# Configure TrustSec Devices

For Cisco ISE to process requests from TrustSec-enabled devices, you must define these TrustSec-enabled devices in Cisco ISE.

- 
- Step 1** Choose **Work Centers > TrustSec > Components > Network Devices**.
  - Step 2** Click **Add**.
  - Step 3** Enter the required information in the **Network Devices** section.
  - Step 4** Check the **Advanced Trustsec Settings** check box to configure a Trustsec-enabled device.
  - Step 5** Click **Submit**.
- 

## OOB TrustSec PAC

All TrustSec network devices possess a TrustSec PAC as part of the EAP-FAST protocol. This is also utilized by the secure RADIUS protocol where the RADIUS shared secret is derived from parameters carried by the PAC. One of these parameters, Initiator-ID, holds the TrustSec network device identity, namely the Device ID.

If a device is identified using TrustSec PAC and there is no match between the Device ID, as configured for that device on Cisco ISE, and the Initiator-ID on the PAC, the authentication fails.

Some TrustSec devices (for example, Cisco firewall ASA) do not support the EAP-FAST protocol. Therefore, Cisco ISE cannot provision these devices with TrustSec PAC over EAP-FAST. Instead, the TrustSec PAC is generated on Cisco ISE and manually copied to the device; hence this is called as the Out of Band (OOB) TrustSec PAC generation.

When you generate a PAC from Cisco ISE, a PAC file encrypted with the Encryption Key is generated.

This section describes the following:

## Generate a TrustSec PAC from the Settings Screen

You can generate a TrustSec PAC from the Settings screen.

- 
- Step 1** Choose **Administration > System > Settings**.
- Step 2** From the Settings navigation pane on the left, click **Protocols**.
- Step 3** Choose **EAP-FAST > Generate PAC**.
- Step 4** Generate TrustSec PAC.
- 

## Generate a TrustSec PAC from the Network Devices Screen

You can generate a TrustSec PAC from the Network Devices screen.

---

- Step 1** Choose **Work Centers > TrustSec > Components > Network Devices**.
- Step 2** Click **Add**. You can also click **Add new device** from the action icon on the Network Devices navigation pane.
- Step 3** If you are adding a new device, provide a device name.
- Step 4** Check the **Advanced TrustSec Settings** check box to configure a TrustSec device.
- Step 5** Under the **Out of Band (OOB) TrustSec PAC** sub section, click **Generate PAC**.
- Step 6** Provide the following details:
- PAC Time to Live—Enter a value in days, weeks, months, or years. By default, the value is one year. The minimum value is one day and the maximum is ten years.
  - Encryption Key—Enter an encryption key. The length of the key must be between 8 and 256 characters. The key can contain uppercase or lowercase letters, or numbers, or a combination of alphanumeric characters.
- The Encryption Key is used to encrypt the PAC in the file that is generated. This key is also used to decrypt the PAC file on the devices. Therefore, it is recommended that the administrator saves the Encryption Key for later use.
- The Identity field specifies the Device ID of a TrustSec network device and is given an initiator ID by the EAP-FAST protocol. If the Identity string entered here does not match that Device ID defined under TrustSec section in the Network Device creation page, authentication will fail.
- The expiration date is calculated based on the PAC Time to Live.
- Step 7** Click **Generate PAC**.
- 

## Generate a TrustSec PAC from the Network Devices List Screen

You can generate a TrustSec PAC from the Network Devices list screen.

---

- Step 1** Choose **Work Centers > TrustSec > Components > Network Devices**.
- Step 2** Click **Network Devices**.
- Step 3** Check the check box next to a device for which you want to generate the TrustSec PAC and click **Generate PAC**.
- Step 4** Provide the details in the fields.
- Step 5** Click **Generate PAC**.
-

# Configure Cisco TrustSec AAA Servers

You can configure a list of Cisco TrustSec-enabled Cisco ISE servers in the AAA server list. Cisco TrustSec devices to authenticate against any of these servers. When you click Push, the new servers in this list download to the TrustSec devices. When a Cisco TrustSec device tries to authenticate, it chooses any Cisco ISE server from this list. If the first server is down or busy, the Cisco TrustSec device can authenticate itself against any of the other servers from this list. By default, the primary Cisco ISE server is a Cisco TrustSec AAA server. We recommend that you configure more Cisco ISE servers for a more reliable Cisco TrustSec environment.

This page lists the Cisco ISE servers in your deployment that you have configured as your Cisco TrustSec AAA servers.

## Before you begin

To perform the following task, you must be a Super Admin or System Admin.

- 
- Step 1** Choose **Work Centers > TrustSec > Components > TrustSec AAA Servers**.
- Step 2** Click **Add**.
- Step 3** Enter the values as described:
- **Name:** Name that you want to assign to the Cisco ISE server in this AAA Server list. This name can be different from the hostname of the Cisco ISE server.
  - **Description:** An optional description.
  - **IP:** IP address of the Cisco ISE server that you are adding to the AAA Server list.
  - **Port:** Port over which communication between the Cisco TrustSec device and server should take place. The default is 1812.
- Step 4** Click **Submit**.
- Step 5** In the **AAA Servers** window that is then displayed, click **Push**.
- 

## What to do next

Configure Security Groups.

# Security Groups Configuration

A Security Group (SG) or Security Group Tag (SGT) is an element that is used in TrustSec policy configuration. SGTs are attached to packets when they move within a trusted network. These packets are tagged when they enter a trusted network (ingress) and untagged when they leave the trusted network (egress).

SGTs are generated in a sequential manner, but you have the option to reserve a range of SGTs for IP to SGT mapping. Cisco ISE skips the reserved numbers while generating SGTs.

TrustSec service uses these SGTs to enforce the TrustSec policy at egress.

You can configure security groups from the following pages in the Admin portal:

- **Work Centers > TrustSec > Components > Security Groups.**
- Directly from egress policy page at **Configure > Create New Security Group.**

You can click the **Push** button to initiate an environment CoA notification after updating multiple SGTs. This environment CoA notification goes to all TrustSec network devices forcing them to start a policy/data refresh request.



---

**Note** Frequent use of the **Push** or **Deploy** button is not advised. When there is a change in a matrix or SGACL, check the notification bar for any pending deployment requests before performing the next deployment operation.

---

## Add Security Groups

Each security group in your TrustSec solution should be assigned a unique SGT. Even though Cisco ISE supports 65,535 SGTs, having fewer number of SGTs would enable you to deploy and manage the TrustSec solution easily. We recommend a maximum of 4,000 SGTs.

### Before you begin

To perform the following task, you must be a Super Admin or System Admin.

- 
- Step 1** Choose **Work Centers > TrustSec > Components > Security Groups.**
  - Step 2** Click **Add** to add a new security group.
  - Step 3** Enter a name and description (optional) for the new security group.
  - Step 4** Check the **Propagate to ACI** check box if you want to propagate this SGT to ACI. The SXP mappings that are related to this SGT will be propagated to ACI only if they belong to a VPN that is selected in the ACI Settings page.  
This option is disabled by default.
  - Step 5** Enter a Tag Value. Tag value can be set to be entered manually or autogenerate. You can also reserve a range for the SGT. You can configure it from the General TrustSec Settings page (**Work Centers > TrustSec > Settings > General TrustSec Settings**).
  - Step 6** Click **Save**.
- 

### What to do next

Configure Security Group Access Control Lists

## Import Security Groups into Cisco ISE

You can import security groups in to a Cisco ISE node using a comma-separated value (CSV) file. You must first update the template before you can import security groups into Cisco ISE. You cannot run import of the same resource type at the same time. For example, you cannot concurrently import security groups from two different import files.

You can download the CSV template from the Admin portal, enter your security group details in the template, and save the template as a CSV file, which you can then import back into Cisco ISE.

While importing security groups, you can stop the import process when Cisco ISE encounters the first error.

- 
- Step 1** Choose **Work Centers > TrustSec > Components > Security Groups**.
  - Step 2** Click **Import**.
  - Step 3** Click **Browse** to choose the CSV file from the system that is running the client browser.
  - Step 4** Check the **Stop Import on First Error** check box.
  - Step 5** Click **Import** .
- 

## Export Security Groups from Cisco ISE

You can export security groups configured in Cisco ISE in the form of a CSV file that you can use to import these security groups into another Cisco ISE node.

- 
- Step 1** Choose **Work Centers > TrustSec > Components > Security Groups**.
  - Step 2** Click **Export**.
  - Step 3** To export security groups, you can do one of the following:
    - Check the check boxes next to the group that you want to export, and choose **Export > Export Selected**.
    - Choose **Export > Export All** to export all the security groups that are defined.
  - Step 4** Save the export.csv file to your local hard disk.
- 

## Add IP SGT Static Mapping

You can use the IP-SGT static mappings to deploy the mappings on TrustSec devices and SXP domains in a unified manner. While creating a new IP-SGT static mapping, you can specify the SXP domains and the devices on which you want to deploy this mapping. You can also associate the IP-SGT mapping to a mapping group.

- 
- Step 1** Choose **Work Centers > TrustSec > Components > IP SGT Static Mapping**.
  - Step 2** Click **Add**.
  - Step 3** In the **New** area displayed, choose **IP Address** or **Hostname** from the drop-down list, and enter the corresponding value in the field next to it.
  - Step 4** If you want to use an existing mapping group, click **Add to a Mapping Group** and select the required group from the **Mapping Group** drop-down list.  
If you want to map this IP address/hostname to an SGT individually, click **Map to SGT Individually** and do the following:
    - Select an SGT from the SGT drop-down list.



- 
- Select the SXP VPN groups on which the mapping must be deployed.
- Specify the devices on which you want to deploy this mapping. You can deploy the mapping on all TrustSec devices, on selected network device groups, or on selected network devices.

**Note** After adding the mappings, you must deploy the mappings on the target network devices using the **Deploy** option. You must do this explicitly even though you have saved the mappings earlier. Click **Check Status** to check the deployment status of the devices.

**Step 5** Click **Save**.

---

## Deploy IP SGT Static Mappings

After adding the mappings, deploy the mappings on the target network devices using the **Deploy** option. You must do this explicitly even if you have saved the mappings earlier. Click **Check Status** to check the deployment status of the devices.

---

**Step 1** From the **Work Centers** tab, choose **TrustSec > Components > IP SGT Static Mapping**.

**Step 2** Check the check boxes near the mappings that you want to deploy. Check the check box at the top if you want to deploy all the mappings.

**Step 3** Click **Deploy**.

All the TrustSec devices are listed in the **Deploy IP SGT Static Mapping** window.

**Step 4** Check the check boxes near the devices or the device groups to which the selected mappings must be deployed.

- Check the check box at the top if you want to select all the devices.
- Use the filter option to search for specific devices.
- If you do not select any device, the selected mappings are deployed on all the TrustSec devices.
- When you select devices to deploy new mapping, ISE selects **all** the devices that will be affected by the new mapping.

**Step 5** Click **Deploy**. The deploy button updates the mapping on all the devices affected by the new maps.

The **Deployment Status** window shows the order in which the devices are updated and the devices that are not getting updated because of an error or because the device is unreachable. After the deployment is complete, the window displays the total number of devices that are successfully updated and the number of devices that are not updated.

---

Use the **Check Status** option in the **IP SGT Static Mapping** page to check if different SGTs are assigned to the same IP address for a specific device. You can use this option to locate the devices that have conflicting mappings, IP addresses that are mapped to multiple SGTs, and the SGTs that are assigned to the same IP address. The **Check Status** option can be used even if device groups, FQDN, hostname, or IPv6 addresses are used in the deployment. You must remove the conflicting mappings or modify the scope of deployment before deploying these mappings.

IPv6 addresses can be used in IP SGT static mappings. These mappings can be propagated using SSH or SXP to specific network devices or network device groups.

If FQDN and hostnames are used, Cisco ISE looks for the corresponding IP addresses in the PAN and PSN nodes while deploying the mappings and checking the deployment status.

Use the **IP SGT Static Mapping of Hostnames** option in the **General TrustSec Settings** window to specify the number of mappings created for the IP addresses returned by the DNS query. Select one of the following options:

- **Create mappings for all the IP addresses returned by a DNS query.**
- **Create mappings only for the first IPv4 address and the first IPv6 address returned by a DNS query.**

## Import IP SGT Static Mappings into Cisco ISE

You can import IP SGT mappings using a CSV file.

You can also download the CSV template from the Admin portal, enter your mapping details, save the template as a CSV file, and then import it back into Cisco ISE.

- 
- Step 1** Choose **Work Centers > TrustSec > Components > IP SGT Static Mapping**.
  - Step 2** Click **Import**.
  - Step 3** Click **Browse** to select the CSV file from the system that is running the client browser.
  - Step 4** Click **Upload**.
- 

## Export IP SGT Static Mappings from Cisco ISE

You can export the IP SGT mappings in the form of a CSV file. You can use this file to import these mappings into another Cisco ISE node.

- 
- Step 1** Choose **Work Centers > TrustSec > Components > IP SGT Static Mapping**.
  - Step 2** Do one of the following:
    - Check the check boxes next to the mappings that you want to export, and choose **Export > Selected**.
    - Choose **Export > All** to export all the mappings.
  - Step 3** Save the mappings.csv file to your local hard disk.
- 

## Add SGT Mapping Group

### Before you begin

To perform the following task, you must be a Super Admin or System Admin.

- 
- Step 1** Choose **Work Centers > TrustSec > Components > IP SGT Static Mapping > Manage Groups**.
- Step 2** Click **Add**.
- Step 3** Enter a name and description for the mapping group.
- Step 4** Do the following:
- Select an SGT from the **SGT** drop-down list.
  - 
  - Select the SXP VPN groups on which the mappings must be deployed.
  - Specify the devices on which you want to deploy the mappings. You can deploy the mappings on all TrustSec devices, on selected network device groups, or on selected network devices.
- Step 5** Click **Save**.

---

You can move an IP SGT mapping from one mapping group to another mapping group.

You can also update or delete the mappings and mapping groups. To update a mapping or mapping group, check the check box next to the mapping or mapping group that you want to update, and then click **Edit**. To delete a mapping or mapping group, check the check box next to the mapping or mapping group that you want to delete, and then click **Trash > Selected**. When a mapping group is deleted, the IP SGT mappings within that group are also deleted.

## Add Security Group Access Control Lists

### Before you begin

To perform the following task, you must be a Super Admin or System Admin.

- 
- Step 1** Choose **Work Centers > TrustSec > Components > Security Group ACLs**.
- Step 2** Click **Add** to create a new Security Group ACL.
- Step 3** Enter the following information:
- Name—Name of the SGACL
  - Description—An optional description of the SGACL
  - IP Version—IP version that this SGACL supports:
    - IPv4—Supports IP version 4 (IPv4)
    - IPv6—Supports IP version 6 (IPv6)
    - Agnostic—Supports both IPv4 and IPv6
  - Security Group ACL Content—Access control list (ACL) commands. For example:  
**permit icmp**  
**deny ip**

The syntax of SGACL input is not checked within ISE. Make sure you are using the correct syntax so that switches, routers and access points can apply them without errors. The default policy can be configured as **permit IP**, **permit ip log**, **deny ip**, or **deny ip log**. A TrustSec network device attaches the default policy to the end of the specific cell policy.

Here are two examples of SGACLs for guidance. Both include a final catch all rule. The first one denies as the final catch all rule, and the second one permits.

#### Permit\_Web\_SGACL

```
permit tcp dst eq 80
permit tcp dst eq 443
deny ip
```

#### Deny\_JumpHost\_Protocols

```
deny tcp dst eq 23
deny tcp dst eq 23
deny tcp dst eq 3389
permit ip
```

The following table lists syntax for SGACL for IOS, IOS XE and NS-OS operating systems.

SGACL CLI and ACEs	Syntax common across IOS, IOS XE, and NX-OS
config acl	deny, exit, no, permit
deny permit	ahp, eigrp, gre, icmp, igmp, ip, nos, ospf, pcp, pim, tcp, udp
deny tcp deny tcp src deny tcp dst	dst, log, src
deny tcp dst eq deny tcp src eq	range 0 65535
deny udp deny udp src deny udp dest	Dst, log, src
deny tcp dst eq www deny tcp src eq www	range 0 65535

**Note** Hypens are not allowed by some Cisco switches. So `permit dst eq 32767-65535` is not valid. Use `permit dst eq range 32767 65535`. Some Cisco switches do not require `eq` in their command syntax. Thus, `permit dst eq 32767-65535` is not valid in these switches. Use `permit dst 32767-65535` or `permit dst range 32767 65535` instead.

**Step 4** Click **Push**.

The Push option initiates a CoA notification that tells the Trustsec devices to immediately request updates from Cisco ISE about the configuration changes.



**Note** Cisco ISE has the following predefined SGACLs: Permit IP, Permit IP Log, Deny IP, and Deny IP Log. You can use these SGACLs to configure the TrustSec Matrix using the GUI or ERS API. Though these SGACLs are not listed in the Security Group ACLs listing page in the GUI, these SGACLs will be listed when you use the ERS API to list the available SGACLs (ERS getAll call).

## Egress Policy

The egress table lists the source and destination SGTs, both reserved and unreserved. This page also allows you to filter the egress table to view specific policies and also to save these preset filters. When the source SGT tries to reach the destination SGT, the TrustSec-capable device enforces the SGACLs based on the TrustSec policy as defined in the Egress Policy. Cisco ISE creates and provisions the policy.

After you create the SGTs and SGACLs, which are the basic building blocks required to create a TrustSec policy, you can establish a relationship between them by assigning SGACLs to source and destination SGTs.

Each combination of a source SGT to a destination SGT is a cell in the Egress Policy.

You can view the Egress Policy in the **Work Centers > TrustSec > TrustSec Policy > Egress Policy** page.

You can view the Egress policy in three different ways:

- Source Tree View
- Destination Tree View
- Matrix View

## Source Tree View

The Source Tree view lists a compact and organized view of source SGTs in a collapsed state. You can expand any source SGT to see the internal table that lists all information related to that selected source SGT. This view displays only the source SGTs that are mapped to destination SGTs. If you expand a specific source SGT, it lists all destination SGTs that are mapped to this source SGT and the corresponding policy (SGACLs) in a table.

You will see three dots (...) next to some fields. This signifies that there is more information contained in the cell. You can position the cursor over the three dots to view the rest of the information in a quick view popup. When you position the cursor over an SGT name or an SGACL name, a quick view popup opens to display the content of that particular SGT or SGACL.

## Destination Tree View

The Destination Tree view lists a compact and organized view of destination SGTs in a collapsed state. You can expand any destination SGTs to see the internal table that lists all information related to that selected destination SGT. This view displays only the destination SGTs that are mapped to source SGTs. If you expand

a specific destination SGT, it lists all source SGTs that are mapped to this destination SGT and the corresponding policy (SGACLs) in a table.

You will see three dots (...) next to some fields. This signifies that there is more information contained in the cell. You can position the cursor over the three dots to view the rest of the information in a quick view popup. When you position the cursor over an SGT name or an SGACL name, a quick view popup opens to display the content of that particular SGT or SGACL.

## Matrix View

The Matrix View of the Egress policy looks like a spreadsheet. It contains two axis:

- Source Axis—The vertical axis lists all the source SGTs.
- Destination Axis—The horizontal axis lists all the destination SGTs.

The mapping of a source SGT to a destination SGT is represented as a cell. If a cell contains data, then it represents that there is a mapping between the corresponding source SGT and the destination SGT. There are two types of cells in the matrix view:

- Mapped cells—When a source and destination pair of SGTs is related to a set of ordered SGACLs and has a specified status.
- Unmapped cells—When a source and destination pair of SGTs is not related to any SGACLs and has no specified status.

The Egress Policy cell displays the source SGT, the destination SGT, and the Final Catch All Rule as a single list under SGACLs, separated by commas. The Final Catch All Rule is not displayed if it is set to None. An empty cell in a matrix represents an unmapped cell.

In the Egress Policy matrix view, you can scroll across the matrix to view the required set of cells. The browser does not load the entire matrix data at once. The browser requests the server for the data that falls in the area you are scrolling in. This prevents memory overflow and performance issues.

You can use the following options in the **View** drop-down list to change the matrix view.

- Condensed with SGACL names—If you select this option, the empty cells are hidden and the SGACL names are displayed in the cells.
- Condensed without SGACL names—The empty cells are hidden and the SGACL names are not displayed in the cells. This view is useful when you want to see more matrix cells and differentiate between the content of the cells using colors, patterns, and icons (cell status).
- Full with SGACL names—If you select this option, the left and upper menus are hidden and the SGACL names are displayed in the cells.
- Full without SGACL names—When this option is selected, the matrix is displayed in full screen mode and the SGACL names are not displayed in the cells.

ISE allows you to create, name, and save the custom views. To create custom views, choose **Show > Create Custom View**. You can also update the view criteria or delete unused views.

The Matrix view has the same GUI elements as the Source and Destination views. However, it has these additional elements:

## Matrix Dimensions

The **Dimension** drop-down list in the Matrix view enables you to set the dimensions of the matrix.

## Import/Export Matrix

The **Import** and **Export** buttons enable you to import or export the matrix.

## Create Custom View

### Before you begin

To perform the following task, you must be a Super Admin or System Admin.

---

**Step 1** In the Matrix View page, select the **Create Custom View** option from the **Show** drop-down list.

**Step 2** In the **Edit View** dialog box, enter the following details:

- View Name—Enter a name for the custom view.
- Source Security Groups—Move the SGTs that you want to include in the custom view to the Show transfer box.
- Show Relevant for Destination—Check this check box if you want to override your selection in the Source Security Group Show transfer box and copy all the entries in the Destination Security Group Hide transfer box. If there are more than 200 entries, the data will not be copied and a warning message will be displayed.
- Destination Security Groups—Move the SGTs that you want to include in the custom view to the Show transfer box.
- Show Relevant for Source—Check this check box if you want to override your selection in the Destination Security Group Show transfer box and copy all the entries in the Source Security Group Hide transfer box.
- Sort Matrix By—Select one of the following options:
  - Manual Order
  - Tag Number
  - SGT Name

**Step 3** Click **Save**.

---

## Matrix Operations

### Navigating through the Matrix

You can navigate through the matrix either by dragging the matrix content area with the cursor or by using horizontal and vertical scroll bars. You can click and hold on a cell to drag it along with the entire matrix content in any direction. The source and destination bar moves along with the cells. The matrix view highlights the cell and the corresponding row (Source SGT) and column (Destination SGT) when a cell is selected. The coordinates (Source SGT and Destination SGT) of the selected cell are displayed below the matrix content area.

### Selecting a Cell in the Matrix

To select a cell in the matrix view, click on it. The selected cell is displayed in different color, and the source and destination SGTs are highlighted. You can deselect a cell either by clicking it again or by selecting another cell. Multiple cell selection is not allowed in the matrix view. Double-click the cell to edit the cell configuration.

### Configure SGACL from Egress Policy

You can create Security Group ACLs directly from the Egress Policy page.

- 
- Step 1** Choose **Work Centers > TrustSec > TrustSec Policy > Egress Policy**.
- Step 2** From the Source or Destination Tree View page, choose **Configure > Create New Security Group ACL**.
- Step 3** Enter the required details and click **Submit**.
- 

## Configure Work Process Settings

### Before you begin

To perform the following task, you must be a Super Admin.

- 
- Step 1** Choose **Work Centers > TrustSec > Settings > Work Process Settings**.
- Step 2** Select one of the following options:
- **Single Matrix**—Select this option if you want to create only one Policy matrix for all the devices in the TrustSec network.
  - **Multiple Matrices**—Allows you to create multiple policy matrices for different scenarios. You can use these matrices to deploy different policies to different network devices.
- Note** The matrices are independent and each network device can be assigned to only one matrix.
- **Production and Staging Matrices with Approval Process**—Select this option if you want to enable the Workflow mode. Select the users that are assigned to the editor and approver roles. You can select the users only from the Policy Admin and Super Admin groups. A user cannot be assigned to both editor and approver roles.
- Ensure that email addresses are configured for the users that are assigned to the editor and approver roles, otherwise email notifications regarding the workflow process will not be sent to these users.
- When the Workflow mode is enabled, a user that is assigned to the editor role can create a staging matrix, select the devices on which he wants to deploy the staging policy, and submit the staging policy to the approver for approval. The user that is assigned to the approver role can review the staging policy and approve or reject the request. The staging policy can be deployed on the selected network devices only after the staging policy is reviewed and approved by the approver.
- Step 3** Check the **Use DEFCONS** check box if you want to create DEFCON matrices.
- DEFCON matrices are standby policy matrices that can be easily deployed in the event of network security breaches. You can create DEFCON matrices for the following severity levels: Critical, Severe, Substantial, and Moderate.



When a DEFCON matrix is activated, the corresponding DEFCON policy is immediately deployed on all the TrustSec network devices. You can use the Deactivate option to remove the DEFCON policy from the network devices.

**Step 4** Click **Save**.

---

## Matrices Listing Page

TrustSec policy matrices and DEFCON matrices are listed in the Matrices Listing page (**Work Centers > TrustSec > TrustSec Policy > Egress Policy > Matrices List**). You can also view the number of devices that are assigned to each matrix.



---

**Note** Matrices Listing page is not displayed when Single Matrix mode is enabled with DEFCON matrix option disabled.

---

You can do the following from the Matrices Listing page:

- Add a new matrix
- Edit an existing matrix
- Delete a matrix
- Duplicate an existing matrix
- Assign NADs to a matrix

You can assign NADs to a matrix by using the Assign NADs option. To do this:

1. In the Assign Network Devices window, select the network devices that you want to assign to a matrix. You can also use the filter option to select the network devices.
2. Select the matrix from the Matrix drop-down list. All the existing matrices and the default matrix are listed in this drop-down list.

After assigning the devices to a matrix, click Push to notify the TrustSec configuration changes to the relevant network devices.

Note the following points while working on the Matrices Listing page:

- You cannot edit, delete, or rename the default matrix.
- While creating a new matrix you can start with a blank matrix or copy the policy from an existing matrix.
- If you delete a matrix, the NADs that are assigned to that matrix are automatically moved to the default matrix.
- When you copy an existing matrix, a copy of the matrix will be created but devices are not automatically assigned to the copied matrix.
- In the Multiple Matrices mode, all the devices are assigned to the default matrix at the initial stage.
- In the Multiple Matrices mode, some of the SGACLs might be shared among the matrices. In such cases, changing an SGACL content will affect all matrices that contain this SGACL in one of their cells.

- Multiple matrices cannot be enabled if staging is in progress.
- When you are moving from Multiple Matrices mode to Single Matrix mode, all the NADs are automatically assigned to the default matrix.
- You cannot delete a DEFCON matrix if it is currently activated.

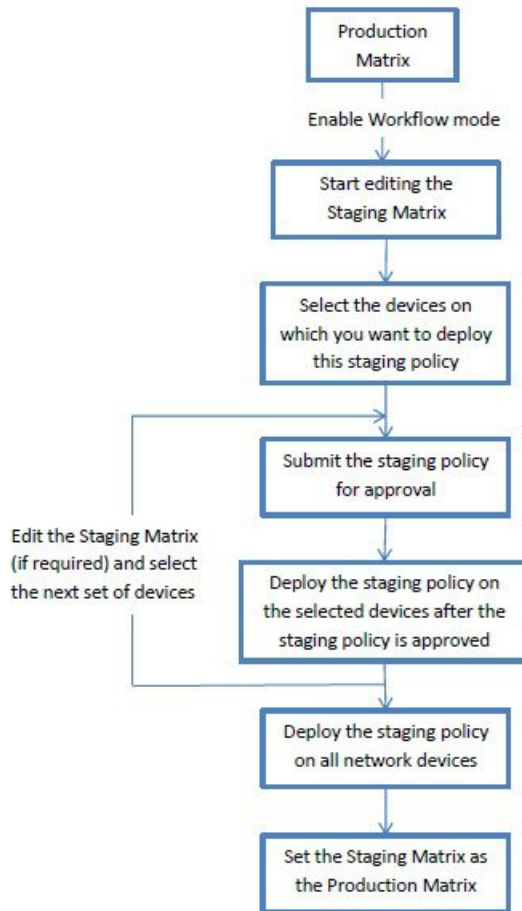
## TrustSec Matrix Workflow Process

The Matrix Workflow feature helps you to test a new policy on a limited set of devices by using a draft version of the matrix (called staging matrix) before deploying the policy on all the network devices. You can submit the staging policy for approval and deploy the staging policy on the selected network devices after it is approved. This feature helps you to deploy the new policy on a limited set of devices, check whether it is working fine, and make any changes, if required. You can continue deploying the policy on next set of devices or on all the devices. When the staging policy is deployed on all the network devices, the staging matrix can be set as the new production matrix.

When the Workflow mode is enabled, a user that is assigned to the editor role can create a staging matrix and edit the matrix cells. The staging matrix is a copy of the production matrix that is currently deployed on the TrustSec network. The editor can select the devices on which he wants to deploy the staging policy and submit the staging policy to the approver for approval. The user that is assigned to the approver role can review the staging policy and approve or reject the request. The staging policy can be deployed on the selected network devices only after the staging policy is reviewed and approved by the approver.

The following figure describes the workflow process.

Figure 64: Matrix Workflow Process



Super Admin user can select the users that are assigned to the editor and approver roles in the Workflow Process Settings page (**Work Centers > TrustSec > Settings > Workflow Process**).

You cannot edit the SGTs and SGACLs after the staging policy is deployed on the selected devices, however, you can edit the matrix cells. You can use the Configuration Delta report to track the difference between the production matrix and the staging matrix. You can also click on the Delta icon on a cell to view the changes made to that cell during the staging process.

The following table describes the different stages of the workflow:

Stage	Description
Staging in Edit	The matrix is moved to Staging in Edit state, when an editor starts editing the staging matrix. After editing the staging matrix, the editor can select the devices on which he wants to deploy the new staging policy.

Stage	Description
Staging Awaiting Approval	<p>After editing the matrix, the editor submits the staging matrix to the approver for review and approval.</p> <p>While submitting the staging matrix for approval, the editor can add the comments that will be included in the email sent to the approver.</p> <p>The approver can review the staging policy and approve or reject the request. The approver can also view the selected network devices and the Configuration Delta report. While approving or rejecting a request, the approver can add the comments that will be included in the email sent to the editor.</p> <p>The editor can cancel the approval request as long as the staging policy is not deployed on any of the network devices.</p>
Deploy Approved	<p>When the approver approves the request, the staging matrix is moved to Deploy Approved state. If the request is rejected, the matrix is moved back to Staging in Edit state.</p> <p>The editor can deploy the staging policy on the selected network devices only after the staging policy is approved by the approver.</p>
Partially Deployed	<p>After the staging matrix is deployed on the selected devices, the matrix is moved to Partially Deployed state. The matrix remains in the Partially Deployed stage till the staging policy is deployed on all the network devices.</p> <p>You cannot edit the SGTs and SGACLs at this stage, however, you can edit the matrix cells.</p> <p>The devices that are not deployed with the latest policy (out-of-sync devices) are displayed in orange (with italic font) in the Network Device Deployment window. This status is also displayed on the deployment progress status bar. The editor can select these devices and request approval to synchronize the devices that were updated in different deployment cycles.</p>
Fully Deployed	<p>The above process is repeated till the staging policy is deployed on all the network devices. When the staging matrix is deployed on all the network devices, the approver can set the staging matrix as the production matrix.</p> <p>We recommend that you take a copy of the production matrix before setting the staging matrix as the new production matrix, because after replacing the production matrix with the staging matrix, you cannot rollback to the previous version of the production matrix.</p>

The options displayed in the Workflow drop-down list vary based on the workflow state and the user role (editor or approver). The following table lists the menu options displayed for an editor and approver:

Workflow state	Menu displayed for Editor	Menu displayed for Approver
Staging in Edit	<ul style="list-style-type: none"> <li>• Select network devices</li> </ul> <p>The following options are available in the Network Device Deployment window:</p> <ul style="list-style-type: none"> <li>• Request approval for selected devices</li> <li>• Request approval for all/filtered Staging list</li> <li>• Request approval for all/filtered Production list</li> <li>• Request approval for all/filtered devices</li> </ul> <ul style="list-style-type: none"> <li>• Request approval for all devices</li> <li>• Discard staging</li> <li>• View deltas</li> </ul>	<ul style="list-style-type: none"> <li>• View network devices</li> <li>• View deltas</li> </ul>
Staging Awaiting Approval	<ul style="list-style-type: none"> <li>• Cancel approval request</li> <li>• View network devices</li> </ul> <p>The following option is available in the Network Device Deployment window:</p> <ul style="list-style-type: none"> <li>• Cancel approval request</li> </ul> <ul style="list-style-type: none"> <li>• View deltas</li> </ul>	<ul style="list-style-type: none"> <li>• Approve deploy</li> <li>• Reject deploy</li> <li>• View network devices</li> </ul> <p>The following options are available in the Network Device Deployment window:</p> <ul style="list-style-type: none"> <li>• Approve deploy</li> <li>• Reject deploy</li> </ul> <ul style="list-style-type: none"> <li>• View deltas</li> </ul>

Workflow state	Menu displayed for Editor	Menu displayed for Approver
Approved - ready to deploy	<ul style="list-style-type: none"> <li>• Deploy</li> <li>• Cancel approval request</li> <li>• View network devices</li> </ul> <p>The following options are available in the Network Device Deployment window:</p> <ul style="list-style-type: none"> <li>• Deploy</li> <li>• Cancel approval request</li> </ul> <ul style="list-style-type: none"> <li>• View deltas</li> </ul>	<ul style="list-style-type: none"> <li>• Reject deploy</li> <li>• View network devices</li> </ul> <p>The following option is available in the Network Device Deployment window:</p> <ul style="list-style-type: none"> <li>• Reject deploy</li> </ul> <ul style="list-style-type: none"> <li>• View deltas</li> </ul>
Partially deployed	<ul style="list-style-type: none"> <li>• Select network devices</li> </ul> <p>The following options are available in the Network Device Deployment window:</p> <ul style="list-style-type: none"> <li>• Request approval for selected devices</li> <li>• Request approval for all/filtered Staging list</li> <li>• Request approval for all/filtered Production list</li> <li>• Request approval for all/filtered devices</li> </ul> <ul style="list-style-type: none"> <li>• Request approval for all devices</li> <li>• View deltas</li> </ul>	<ul style="list-style-type: none"> <li>• View network devices</li> <li>• View deltas</li> </ul>

Workflow state	Menu displayed for Editor	Menu displayed for Approver
Fully deployed	<ul style="list-style-type: none"> <li>Select network devices</li> </ul> <p>The following options are available in the Network Device Deployment window:</p> <ul style="list-style-type: none"> <li>Request approval for selected devices</li> <li>Request approval for all/filtered Staging list</li> <li>Request approval for all/filtered Production list</li> <li>Request approval for all/filtered devices</li> <li>Request approval for all devices</li> <li>View deltas</li> </ul>	<ul style="list-style-type: none"> <li>Set as production</li> <li>View network devices</li> <li>View deltas</li> </ul>

The workflow options are also available in the Source and Destination Tree view.

You can view the list of devices that downloaded the staging/production policy by using the TrustSec Policy Download report (Work Centers > TrustSec > Reports). The TrustSec Policy Download lists the requests sent by the network devices for policy (SGT/SGACL) download and the details sent by ISE. If the Workflow mode is enabled, the requests can be filtered for production or staging matrix.

## Egress Policy Table Cells Configuration

Cisco ISE allows you to configure cells using various options that are available in the tool bar. Cisco ISE does not allow a cell configuration if the selected source and destination SGTs are identical to a mapped cell.

### Add the Mapping of Egress Policy Cells

You can add the mapping cell for Egress Policy from the Policy page.

**Step 1** Choose **Work Centers > TrustSec > TrustSec Policy > Egress Policy**.

**Step 2** To select the matrix cells, do the following:

- In the matrix view, click a cell to select it.
- In the Source and Destination tree view, check the check box of a row in the internal table to select it.

**Step 3** Click **Add** to add a new mapping cell.

**Step 4** Select appropriate values for:

- Source Security Group

- Destination Security Group
- Status, Security Group ACLs
- Final Catch All Rule

**Step 5** Click **Save**.

---

## Export Egress Policy

---

**Step 1** **Work Centers > TrustSec > TrustSec Policy > Egress Policy > Matrix > Export.**

**Step 2** Check the **Include Empty Cells** check box if you want to include the empty cells (which do not have any SGACL configured) in the exported file.

When this option is enabled, the whole matrix is exported and the empty cells are marked with the "Empty" keyword in the SGACL column.

**Note** Ensure that the exported file does not contain more than 500000 lines, otherwise the export may fail.

**Step 3** Select one of the following options:

- Local Disk—Select this option if you want to export the file to a local drive.
- Repository—Select this option if you want to export the file to a remote repository.

You must configure the repositories before exporting the file. To configure the repositories, choose **Administration > Maintenance > Repository**. Ensure that read and write access privileges are provided for the repository that you have selected.

You can encrypt the exported file by using an encryption key.

You can modify the file name. File name should not include more than 50 characters. By default, the file name includes the current time, however, if the same file name exists on the remote repository, the file will be overwritten.

**Step 4** Click **Export**.

---

## Import Egress Policy

You can create the egress policy offline and then import it in to Cisco ISE. If you have a large number of security group tags, then creating the security group ACL mapping one by one might take some time. Instead, creating the egress policy offline and importing it in to Cisco ISE saves time for you. During import, Cisco ISE appends the entries from the CSV file to the egress policy matrix and does not overwrite the data.

Egress policy import fails if the:

- Source or destination SGTs do not exist
- SGACL does not exist
- Monitor status is different than what is currently configured in Cisco ISE for that cell



- 
- Step 1** Choose **Work Centers > TrustSec > TrustSec Policy > Egress Policy > Matrix > Import**.
- Step 2** Click **Generate a Template**.
- Step 3** Download the template (CSV file) from the Egress Policy page and enter the following information in the CSV file:
- Source SGT
  - Destination SGT
  - SGACL
  - Monitor status (enabled, disabled, or monitored)
- Step 4** Check the **Overwrite Existing Data with New Data** check box if you want to overwrite the existing policy with the one that you are importing. If empty cells (cells that are marked with the "Empty" keyword in the SGACL column) are included in the imported file, the existing policy in the corresponding matrix cells will be deleted.
- While exporting the egress policy, if you want to include the empty cells, check the **Include Empty Cells** check box. For more information, see [Export Egress Policy, on page 820](#).
- Step 5** Click **Validate File** to validate the imported file. Cisco ISE validates the CSV structure, SGT names, SGACL, and file size before importing the file.
- Step 6** Check the **Stop Import on First Error** check box for Cisco ISE to cancel the import if it encounters any errors.
- Step 7** Click **Import**.
- 

## Configure SGT from Egress Policy

You can create Security Groups directly from the Egress Policy page.

---

- Step 1** Choose **Work Centers > TrustSec > TrustSec Policy > Egress Policy**.
- Step 2** From the Source or Destination Tree View page, choose **Configure > Create New Security Group**.
- Step 3** Enter the required details and click **Submit**.
- 

## Monitor Mode

The Monitor All option in the egress policy allows you to change the entire egress policy configuration status to monitor mode with a single click. Check the **Monitor All** check box in the egress policy page to change the egress policy configuration status of all the cells to monitor mode. When you check the Monitor All check box, the following changes take place in the configuration status:

- The cells whose status is Enabled will act as monitored but appears as if they are enabled.
- The cells whose status is Disable will not be affected.
- The cells whose status is Monitor will remain Monitored.

Uncheck the **Monitor All** check box to restore the original configuration status. It does not change the actual status of the cell in the database. When you deselect **Monitor All**, each cell in the egress policy regains its original configuration status.

## Features of Monitor Mode

The monitoring functionality of the monitor mode helps you to:

- Know how much traffic is filtered but monitored by the monitor mode
- Know that SGT-DGT pair is in monitor mode or enforce mode, and observe if there is any unusual packet drop is happening in the network
- Understand that SGACL drop is actually enforced by enforce mode or permitted by monitor mode
- Create custom reports based on the type of mode (monitor, enforce, or both)
- Identify which SGACL has been applied on NAD and display discrepancy, if any

## The Unknown Security Group

The Unknown security group is a pre-configured security group that cannot be modified and represents the Trustsec with tag value 0.

The Cisco security group network devices request for cells that refer to the unknown SGT when they do not have an SGT of either source or destination. If only the source is unknown, the request applies to the <unknown, Destination SGT> cell. If only the destination is unknown, the request applies to the <source SGT, unknown> cell. If both the source and destination are unknown, the request applies to the <Unknown, Unknown> cell.

## Default Policy

Default Policy refers to the <ANY,ANY> cell. Any source SGT is mapped to any destination SGT. Here, the ANY SGT cannot be modified and it is not listed in any source or destination SGTs. The ANY SGT can only be paired with ANY SGT. It cannot be paired with any other SGTs. A TrustSec network device attaches the default policy to the end of the specific cell policy.

- If a cell is empty, that means it contains the default policy alone.
- If a cell contains some policy, the resulting policy is a combination of the cell specific policy followed by the default policy.

According to Cisco ISE, the cell policy and the default policy are two separate sets of SGACLs that the devices get in response to two separate policy queries.

Configuration of the default policy is different from other cells:

- Status can take only two values, Enabled or Monitored.
- Security Group ACLs is an optional field for the default policy, so can be left empty.
- Final Catch All Rule can be any of the following: Permit IP, Deny IP, Permit IP log, or Deny IP log. Clearly the None option is not available here because there is no safety net beyond the default policy.

## Push Button

The Push option in the egress policy initiates a CoA notification that calls the Trustsec devices to immediately request for updates from Cisco ISE regarding the configuration changes in the egress policy.

# SGT Assignment

Cisco ISE allows you to assign an SGT to a TrustSec device if you know the device hostname or IP address. When a device with the specific hostname or IP address joins the network, Cisco ISE will assign the SGT before authenticating it.

The following SGTs are created by default:

- SGT\_TrustSecDevices
- SGT\_NetworkServices
- SGT\_Employee
- SGT\_Contractor
- SGT\_Guest
- SGT\_ProductionUser
- SGT\_Developer
- SGT\_Auditor
- SGT\_PointofSale
- SGT\_ProductionServers
- SGT\_DevelopmentServers
- SGT\_TestServers
- SGT\_PCIServers
- SGT\_BYOD
- SGT\_Quarantine

Sometimes, devices need to be manually configured to map the security group tags to the endpoint. You can create this mapping from the Security Group Mappings page. Before you perform this action, ensure that you have reserved a range of SGTs.

ISE allows you to create up to 10,000 IP-to-SGT mappings. You can create IP-to-SGT mapping groups to logically group such large scale mappings. Each group of IP-to-SGT mappings contains a list of IP addresses, a single security group it would map to and a network device or network device group which is the deployment target for those mappings.


## NDAC Authorization

You can configure the TrustSec policy by assigning SGTs to devices. You can assign security groups to devices based on TrustSec device ID attribute.

## Configure NDAC Authorization

### Before you begin

- Ensure that you create the security groups for use in the policy.
- To perform the following task, you must be a Super Admin or System Admin.

- 
- Step 1** Choose **Work Centers > TrustSec > TrustSec Policy > Network Device Authorization**.
- Step 2** Click the **Action** icon on the right-hand side of the Default Rule row, and click **Insert New Row Above**.
- Step 3** Enter the name for this rule.
- Step 4** Click the plus sign (+) next to **Conditions** to add a policy condition.
- Step 5** You can click **Create New Condition (Advance Option)** and create a new condition.
- Step 6** From the **Security Group** drop-down list, select the SGT that you want to assign if this condition evaluates to true.
- Step 7** Click the **Action** icon from this row to add additional rules based on device attributes either above or below the current rule. You can repeat this process to create all the rules that you need for the TrustSec policy. You can drag and drop the rules to reorder them by clicking the  icon. You can also duplicate an existing condition, but ensure that you change the policy name.
- The first rule that evaluates to true determines the result of the evaluation. If none of the rules match, the default rule will be applied; you can edit the default rule to specify the SGT that must be applied to the device if none of the rules match.
- Step 8** Click **Save** to save your TrustSec policy.
- If a TrustSec device tries to authenticate after you have configured the network device policy, the device will get its SGT and the SGT of its peers and will be able to download all the relevant details.
- 

## Configure End User Authorization

Cisco ISE allows you to assign a security group as the result of an authorization policy evaluation. Using this option, you can assign a security group to users and end points.

### Before you begin

- Read the information on authorization policies.
- To perform the following task, you must be a Super Admin or System Admin.

- 
- Step 1** Choose **Work Centers > TrustSec > Authorization Policy**.
- Step 2** Create a new authorization policy.
- Step 3** Select a security group, for Permissions.

If the conditions specified in this authorization policy is true for a user or endpoint, then this security group will be assigned to that user or endpoint and all data packets that are sent by this user or endpoint will be tagged with this particular SGT.

---

## TrustSec Configuration and Policy Push

Cisco ISE supports Change of Authorization (CoA) which allows Cisco ISE to notify TrustSec devices about TrustSec configuration and policy changes, so that the devices can reply with requests to get the relevant data.

A CoA notification can trigger a TrustSec network device to send either an Environment CoA or a Policy CoA.

You can also push a configuration change to devices that do not intrinsically support the TrustSec CoA feature.

## CoA Supported Network Devices

Cisco ISE sends CoA notifications to the following network devices:

- Network device with single IP address (subnets are not supported)
- Network device configured as a TrustSec device
- Network device set as CoA supported

When Cisco ISE is deployed in a distributed environment where there are several secondaries that interoperate with different sets of devices, CoA requests are sent from Cisco ISE primary node to all the network devices. Therefore, TrustSec network devices need to be configured with the Cisco ISE primary node as the CoA client.

The devices return CoA NAK or ACK back to the Cisco ISE primary node. However, the following TrustSec session coming from the network device would be sent to the Cisco ISE node to which the network device sends all its other AAA requests and not necessarily to the primary node.

## Push Configuration Changes to Non-CoA Supporting Devices

Some platforms do not support Cisco ISE's "Push" feature for Change of Authorization (CoA), for example: some versions of the Nexus network device. For this case, ISE will connect to the network device and make it to trigger an updated configuration request towards ISE. To achieve this, ISE opens an SSHv2 tunnel to the network device, and the Cisco ISE sends a command that triggers a refresh of the TrustSec policy matrix. This method can also be carried out on network platforms that support CoA pushing.

---

**Step 1** Choose **Work Centers > Device Administration > Network Resources > Network Devices**.

**Step 2** Check the checkbox next to the required network device and click **Edit**.

Verify that the network device's name, IP address, RADIUS and TrustSec settings are properly configured.

**Step 3** Scroll down to **Advanced TrustSec Settings**, and in the **TrustSec Notifications and Updates** section, check the **Send configuration changes to device** checkbox, and click the **CLI (SSH)** radio button.

**Step 4** (Optional) Provide an SSH key.

- Step 5** Check the **Include this device when deploying Security Group Tag Mapping Updates** check box, for this SGA device to obtain the IP-SGT mappings using device interface credentials.
- Step 6** Enter the username and password of the user having privileges to edit the device configuration in the Exec mode.
- Step 7** (Optional) Enter the password to enable Exec mode password for the device that would allow you to edit its configuration. You can click **Show** to display the Exec mode password that is already configured for this device.
- Step 8** Click **Submit** at the bottom of the page.

---

The network device is now configured to push Trustsec changes. After you change a Cisco ISE policy, click **Push** to have the new configuration reflected on the network device.

## SSH Key Validation

You may want to harden security by using an SSH key. Cisco ISE supports this with its SSH key validation feature.

To use this feature, you open an SSHv2 tunnel from the Cisco ISE to the network device, then use the network device's own CLI to retrieve the SSH key. You then copy this key and paste it into Cisco ISE for validation. Cisco ISE terminates the connection if the SSH key is wrong.

**Limitation:** Currently, Cisco ISE can validate only one IP (not on ranges of IP, or subnets within an IP)

### Before you begin

You will require:

- Login credentials
- CLI command to retrieve the SSH key

for the network device with which you want the Cisco ISE to communicate securely.

- 
- Step 1** On the network device:
- a) Log on to the network device with which you want the Cisco ISE to communicate using SSH key validation.
  - b) Use the device's CLI to show the SSH key.
- Example:**
- For Catalyst devices, the command is: `sho ip ssh`.
- c) Copy the SSH key which is displayed.
- Step 2** From the Cisco ISE user interface:
- a) Choose **Work Centers > Device Administration > Network Resources > Network Devices**, and verify the required network device's name, IP address, RADIUS and TrustSec settings are properly configured.
  - b) Scroll down to **Advanced TrustSec Settings**, and in the **TrustSec Notifications and Updates** section, check the **Send configuration changes to device** checkbox, and click the **CLI (SSH)** radio button.
  - c) In the **SSH Key** field, paste the SSH key retrieved previously from the network device.
  - d) Click **Submit** at the bottom of the page.

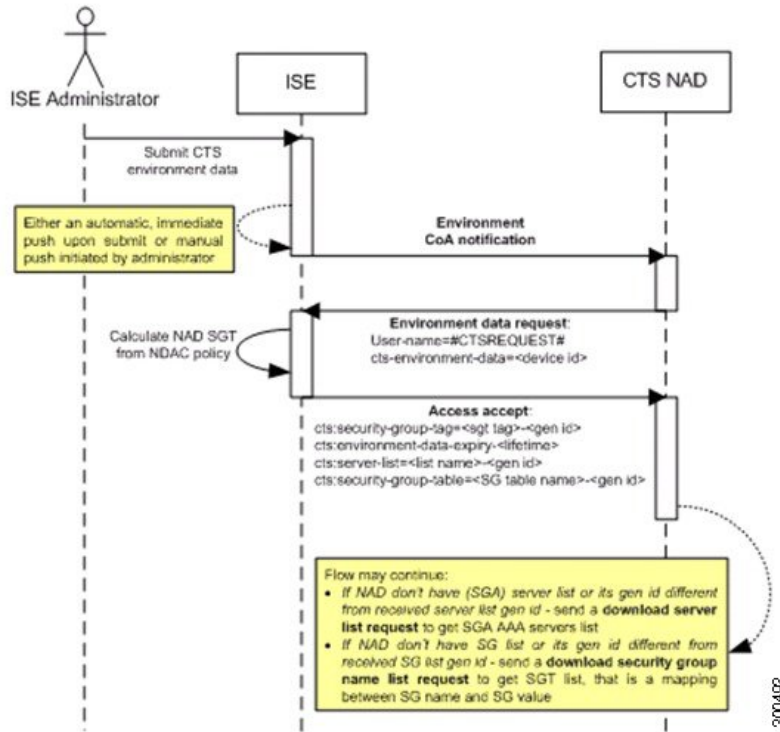
---

The network device is now communicating with the Cisco ISE using SSH key validation.

# Environment CoA Notification Flow

The following figure depicts the Environment CoA notification flow.

Figure 65: Environment CoA Notification Flow



1. Cisco ISE sends an environment CoA notification to the TrustSec network device.
2. The device returns an environment data request.
3. In response to the environment data request, Cisco ISE returns:
  - The environment data of the device that sent the request—This includes the TrustSec device’s SGT (as inferred from the NDAC policy) and download environment TTL.
  - The name and generation ID of the TrustSec AAA server list.
  - The names and generation IDs of (potentially multiple) SGT tables—These tables list SGT name versus SGT value, and together these tables hold the full list of SGTs.
4. If the device does not hold a TrustSec AAA server list, or the generation ID is different from the generation ID that is received, the device sends another request to get the AAA server list content.
5. If the device does not hold an SGT table listed in the response, or the generation ID is different from the generation ID that is received, the device sends another request to get the content of that SGT table.

## Environment CoA Triggers

An Environment CoA can be triggered for:

- Network devices

- Security groups
- AAA servers


### Trigger Environment CoA for Network Devices

To trigger an Environment CoA for the Network devices, complete the following steps:

- 
- Step 1** Choose **Work Centers > Device Administration > Network Resources > Network Devices**.
- Step 2** Add or edit a network device.
- Step 3** Update TrustSec Notifications and Updates parameters under the Advanced TrustSec Settings section.
- Changing the environment attribute is notified only to the specific TrustSec network device where the change took place. Because only a single device is impacted, an environmental CoA notification is sent immediately upon submission. The result is a device update of its environment attribute.
- 

### Trigger Environment CoA for Security Groups

To trigger an Environment CoA for the security groups, complete the following steps.

- 
- Step 1** Choose In the Cisco ISE GUI, click the **Menu** icon () and choose **Work Centers > TrustSec > Components > Security Groups**.
- Step 2** In the Security Group page, change the name of an SGT, which will change the name of the mapping value of that SGT. This triggers an environmental change.
- Step 3** Click the **Push** button to initiate an environment CoA notification after changing the names of multiple SGTs. This environment CoA notification goes to all TrustSec network devices and provides an update of all SGTs that were changed.
- 

### Trigger Environment CoA for TrustSec AAA Servers

To trigger an Environment CoA for the TrustSec AAA servers, complete the following steps.

- 
- Step 1** Choose **Work Centers > TrustSec > Components > TrustSec AAA Servers**.
- Step 2** In the TrustSec AAA Servers page create, delete or update the configuration of a TrustSec AAA server. This triggers an environment change.
- Step 3** Click the **Push** button to initiate an environment CoA notification after you configure multiple TrustSec AAA servers. This environment CoA notification goes to all TrustSec network devices and provides an update of all TrustSec AAA servers that were changed.
- 

### Trigger Environment CoA for NDAC Policy

To trigger an Environment CoA for the NDAC Policies, complete the following steps.

- 
- Step 1** Choose **Work Centers > TrustSec > Policy > Network Device Authorization**.



In the NDAC policy page you can create, delete, or update rules of the NDAC policy. These environment changes are notified to all network devices.

**Step 2** Choose **Work Centers > TrustSec > TrustSec Policy > Network Device Authorization**.

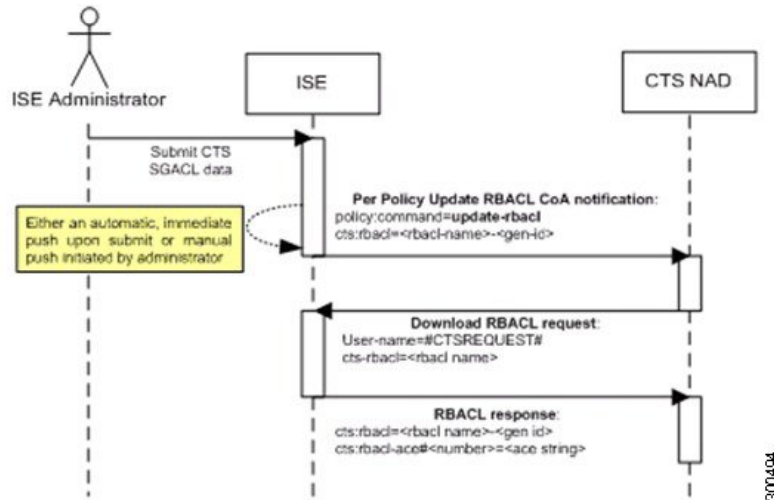
In the NDAC policy page you can create, delete, or update rules of the NDAC policy. These environment changes are notified to all network devices.

**Step 3** You can initiate an environment CoA notification by clicking the **Push** button in the NDAC policy page. This environment CoA notification goes to all TrustSec network devices and provides an update of network device own SGT.

## Update SGACL Content Flow

The following figure depicts the Update SGACL Content flow.

**Figure 66: Update SGACL Content Flow**



1. Cisco ISE sends an update SGACL named list CoA notification to a TrustSec network device. The notification contains the SGACL name and the generation ID.
2. The device may replay with an SGACL data request if both of the following terms are fulfilled:  
 If the SGACL is part of an egress cell that the device holds. The device holds a subset of the egress policy data, which are the cells related to the SGTs of its neighboring devices and endpoints (egress policy columns of selected destination SGTs).  
 The generation ID in the CoA notification is different from the generation ID that the device holds for this SGACL.
3. In response to the SGACL data request, Cisco ISE returns the content of the SGACL (the ACE).

## Initiate an Update SGACL Named List CoA

To trigger an Update SGACL Named List CoA, complete the following steps:

- Step 1** Choose **Work Centers > TrustSec > Components > Security Group ACLs**.
- Step 2** Change the content of the SGACL. After you submit a SGACL, it promotes the generation ID of the SGACL.
- Step 3** Click the **Push** button to initiate an Update SGACL Named List CoA notification after you change the content of multiple SGACLs. This notification goes to all TrustSec network devices, and provides an update of that SGACL content on the relevant devices.

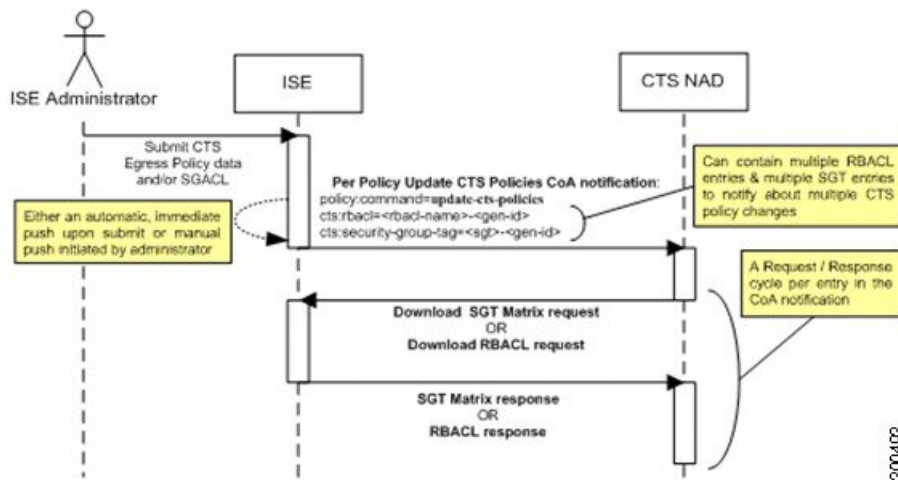
Changing the name or the IP version of an SGACL does not change its generation ID; hence it does not require sending an update SGACL named list CoA notification.

However, changing the name or IP version of an SGACL that is in use in the egress policy indicates a change in the cell that contains that SGACL, and this changes the generation ID of the destination SGT of that cell.

## Policies Update CoA Notification Flow

The following figure depicts the Policies CoA Notification flow.

Figure 67: Policies CoA Notification flow

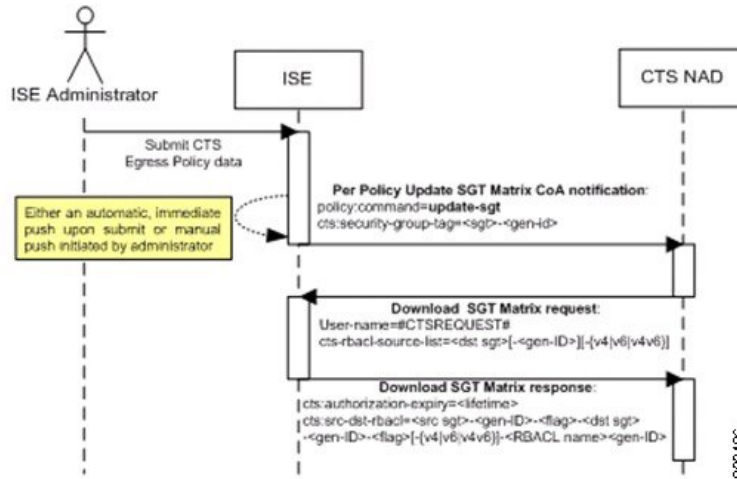


1. Cisco ISE sends an update policies CoA notification to a TrustSec network device. The notification may contain multiple SGACL names and their generation IDs, and multiple SGT values and their generation IDs.
2. The device may replay with multiple SGACL data requests and/or multiple SGT data.
3. In response to each SGACL data request or SGT data request, Cisco ISE returns the relevant data.

## Update SGT Matrix CoA Flow

The following figure depicts the Update SGT Matrix CoA flow.

Figure 68: Update SGT Matrix CoA flow



1. Cisco ISE sends an updated SGT matrix CoA notification to a TrustSec network device. The notification contains the SGT value and the generation ID.
2. The device may replay with an SGT data request if both the following terms are fulfilled:  
 If the SGT is the SGT of a neighboring device or endpoint, the device downloads and hold the cells related to SGTs of neighboring devices and endpoints (a destination SGT).  
 The generation ID in the CoA notification is different from the generation ID that the device holds for this SGT.
3. In response to the SGT data request, Cisco ISE returns the data of all egress cells, such as the source and destination SGTs, the status of the cell, and an ordered list of the SGACL names configured in that cell.

## Initiate Update SGT Matrix CoA from Egress Policy

- Step 1** Choose **Work Centers > TrustSec > TrustSec Policy > Egress Policy**.
- Step 2** On the Egress Policy page, change the content of a cell (status, SGACLs).
- Step 3** After you submit the changes, it promotes the generation ID of the destination SGT of that cell.
- Step 4** Click the **Push** button to initiate the Update SGT matrix CoA notification after you change the content of multiple egress cells. This notification goes to all TrustSec network devices, and provides an update of cells content on the relevant devices.

## TrustSec CoA Summary

The following table summarizes the various scenarios that may require initiating a TrustSec CoA, the type of CoA used in each scenario, and the related UI pages.

Table 69: TrustSec CoA Summary

UI Page	Operation that triggers CoA	How it is triggered	CoA type	Send to
Network Device	Changing the environment TTL in the TrustSec section of the page	Upon successful Submit of TrustSec network device	Environment	The specific network device
TrustSec AAA Server	Any change in the TrustSec AAA server (create, update, delete, reorder)	Accumulative changes can be pushed by clicking the Push button on the TrustSec AAA servers list page.	Environment	All TrustSec network devices
Security Group	Any change in the SGT (create, rename, delete)	Accumulative changes can be pushed by clicking the Push button on the SGT list page.	Environment	All TrustSec network devices
NDAC Policy	Any change in the NDAC policy (create, update, delete)	Accumulative changes can be pushed by clicking the Push button on the NDAC policy page.	Environment	All TrustSec network devices
SGACL	Changing SGACL ACE	Accumulative changes can be pushed by clicking the Push button on the SGACL list page.	Update RBACL named list	All TrustSec network devices
	Changing SGACL name or IP version	Accumulative changes can be pushed by clicking the Push button on the SGACL list page or the policy push button in the Egress table.	Update SGT matrix	All TrustSec network devices
Egress Policy	Any operation that changes the generation ID of an SGT	Accumulative changes can be pushed by clicking the Push button on the egress policy page.	Update SGT matrix	All TrustSec network devices

# Security Group Tag Exchange Protocol

Security Group Tag (SGT) Exchange Protocol (SXP) is used to propagate the SGTs across network devices that do not have hardware support for TrustSec. SXP is used to transport an endpoint's SGT along with the IP address from one SGT-aware network device to another. The data that SXP transports is called as IP-SGT mapping. The SGT to which an endpoint belongs can be assigned statically or dynamically, and the SGT can be used as a classifier in network policies.

To enable SXP service on a node, check the Enable SXP Service check box in the General Node Settings page. You must also specify the interface to be used for SXP service.

SXP uses TCP as its transport protocol to set up SXP connection between two separate network devices. Each SXP connection has one peer designated as SXP speaker and the other peer as SXP listener. The peers can also be configured in a bi-directional mode where each of them act as both speaker and listener. Connections can be initiated by either peers, but mapping information is always propagated from a speaker to a listener.



**Note** Session bindings are always propagated on the default SXP domain.

The following table lists some of the common terms used in the SXP environment:

IP-SGT mapping	The IP Address to SGT mapping that is exchanged over SXP connection.  To view all the mappings learned by the SXP devices (including static mappings and session mappings), choose <b>Work Centers &gt; TrustSec &gt; SXP &gt; All SXP Mappings</b> .
SXP Speaker	The peer that sends the IP-SGT mappings over the SXP connection.
SXP Listener	The peer that receives the IP-SGT mappings over the SXP connection.

To view the SXP peer devices that are added to Cisco ISE, choose **Work centers > TrustSec > SXP > SXP Devices**.



**Note** We recommend that you run the SXP service on a standalone node.

Note the following points while using the SXP service:

- When you deregister an SXP node and reregister it back to the existing deployment, the SXP devices that are connected to that node are removed from the deployment. These devices are not displayed in the **SXP Devices** window (**Work Centers > TrustSec > SXP > SXP Devices**). You must manually re-add these devices after reregistering the SXP node to the deployment. However, the SXP devices are not removed if the SXP service on an SXP node is disabled.
- Cisco ISE does not support multiple SXP session bindings with same IP address.

- If the RADIUS accounting updates are too frequent (for example, around 6 to 8 accounting updates in few seconds), sometimes the accounting update packet might be dropped and SXP might not receive the IP-SGT binding.
- After upgrading from a previous version of ISE, SXP does not start automatically. After the upgrade, you must change the SXP password and restart the SXP process.

## Add an SXP Device

### Before you begin

To perform the following task, you must be a Super Admin or System Admin.

**Step 1** Choose **Work Centers > TrustSec > SXP > SXP Devices**.

**Step 2** Click **Add**.

**Step 3** Enter the device details:

- Click **Upload from a CSV file** to add the SXP devices using a CSV file. Browse and select the CSV file, and then click **Upload**.

You can also download the CSV template file, fill in the details of the devices that you want to add, and upload the CSV file.

- Click **Add Single Device** to add the device details manually for each SXP device.

Enter the name, IP address, SXP role (listener, speaker, or both), password type, SXP version, and connected PSNs for the peer device. You must also specify the SXP domain to which the peer device is connected.

**Step 4** (Optional) Click **Advanced Settings** and enter the following details:

- **Minimum Acceptable Hold Timer**—Specify the time, in seconds, a speaker will send keepalive messages for keeping the connection alive. The valid range is from 1 to 65534.
- **Keep Alive Timer**—Used by a speaker to trigger the dispatch of keepalive messages during intervals when no other information is exported via update messages. The valid range is from 0 to 64000.

**Step 5** Click **Save**.

## Add an SXP Domain Filter

You can view all the mappings learned by the SXP devices (including static mappings and session mappings) on the **Work Centers > TrustSec > SXP > All SXP Mappings** page.

By default, session mappings learnt from the network devices are sent only to the default VPN group. You can create SXP domain filters to send the mappings to different SXP domains (VPNs).

To add an SXP domain filter:

### Before you begin

To perform the following task, you must be a Super Admin or System Admin.

---

**Step 1** Choose **Work Centers > TrustSec > SXP > All SXP Mappings**.

**Step 2** Click **Add SXP Domain Filter**.

**Step 3** Do the following:

- Enter the subnet details. The session mappings of the network devices with IP addresses from this subnet are sent to the SXP domain (VPN) that is selected in the **SXP Domain** field.
- Select an SGT from the SGT drop-down list. The session mappings that are related to this SGT are sent to the SXP domain that is selected in the **SXP Domain** field.

If you have specified both Subnet and SGT, the session mappings that match this filter are sent to the SXP domain that you have selected in the **SXP Domain** field.

- Select the SXP domain to which the mappings must be sent.

**Step 4** Click **Save**.

---

You can also update or delete the SXP domain filters. To update a filter, click **Manage SXP Domain Filter**, check the check box next to the filter that you want to update, and then click **Edit**. To delete a filter, check the check box next to the filter that you want to delete, and then click **Trash > Selected**.

## Configure SXP Settings

### Before you begin

To perform the following task, you must be a Super Admin or System Admin.

---

**Step 1** Choose **Work Centers > TrustSec > Settings > SXP Settings**.

**Step 2** Enter the required details in the SXP Settings page.

If you uncheck the **Publish SXP Bindings on PxGrid** check box, the IP-SGT mappings will not be propagated across the network devices.

**Step 3** Click **Save**.

**Note** When the SXP settings are changed, the SXP service is restarted.

---

## TrustSec-Cisco ACI Integration

Cisco ISE can synchronize SGTs and SXP mappings with the Internal Endpoint Groups (IEPGs), External Endpoint Groups (EPPGs), and endpoint (EP) configuration of Cisco Application Centric Infrastructure (Cisco ACI).

Cisco ISE supports packets coming from the Cisco ACI domain to the TrustSec domain by synchronizing the IEPGs, and creating correlating read-only SGTs in ISE. These SGTs map the endpoints configured in Cisco ACI, and create correlating SXP mappings in ISE. The SGTs displayed on the Security Groups page (with the value "Cisco ACI" in the Learned From field). You can view the SXP mappings on the All SXP Mappings page. These mappings are sent to Cisco ACI only if the Policy Plane option is selected (in the Cisco ACI Settings page) and the SXP device belongs to an SXP domain, that you configured on the Cisco ACI Settings page.




---

**Note** You can't use read-only SGTs in IP-SGT mappings, mapping groups, and SXP local mappings.

---

When you add a Security Group, you can specify whether the SGT is sent to Cisco ACI by enabling the **Propagate to ACI** option. When this option is enabled, the SXP mappings that are related to this SGT are sent to Cisco ACI. But, only if the Policy Plane option is selected (in the Cisco ACI Settings page) and the SXP device belongs to an SXP Domain, which you configure on the Cisco ACI Settings page.

Cisco ACI supports the packets that are sent from the TrustSec domain to the Cisco ACI domain by synchronizing the SGTs, and creating correlating EEPGs. Cisco ACI creates subnets under EEPG based on the SXP mappings from Cisco ISE. These subnets are not deleted from Cisco ACI, when the corresponding SXP mappings are deleted in Cisco ISE.

When an IEPG is updated in Cisco ACI, the corresponding SGT configuration is updated in Cisco ISE. A new EEPG is created in Cisco ACI, when an SGT is added in Cisco ISE. When an SGT is deleted, the corresponding EEPG is deleted in Cisco ACI. When an endpoint is updated in Cisco ACI, the corresponding SXP mapping is updated in Cisco ISE.

If the connection with the Cisco ACI server is lost, Cisco ISE re-synchronizes the data again when the connection is reestablished.




---

**Note** You must enable the SXP service to use the Cisco ACI integration feature.

---




---

**Note** To successfully integrate Cisco ISE and Cisco ACI, the signed certificate should have proper SAN fields. Cisco ISE will use values specified in the SAN extension property of the certificate presented by the APIC server.

---




---

**Note** Only IPv4-SXP bindings with Cisco ACI are currently supported by Cisco ISE. IPv6-SGT bindings from Cisco ACI are not supported.

---

## Configure Cisco ACI Settings

### Before you begin

To perform the following task, you must be a Super Admin or System Admin.



- 
- Step 1** Choose **Administration > System > Certificates > Trusted Certificates > Import**.
- Step 2** Import the Cisco ACI certificate. For more information, see [Import a Root Certificate to Trusted Certificate Store, on page 156](#).
- Step 3** Choose **Work Centers > TrustSec > Settings > ACI Settings**.
- Step 4** Check the **TrustSec-ACI Policy Element Exchange** check box to synchronize SGTs and SXP mappings with IEPGs, EEPGs, and endpoint configuration of Cisco ACI.
- Step 5** Select one of the following options:
- **Policy Plane**—Select this option if you want Cisco ISE to interact only with APIC data center to interchange SGT, EPG, and SXP information.
  - **Data Plane**—If you select this option, in addition to SGT and EPG, additional information is provided to the ASR devices that are connected between the TrustSec network and the APIC-controlled network. These ASR devices must contain the Translation tables for SGT-to-EPG and EPG-to-SGT conversion.
- Note** SXP mappings are not propagated to Cisco ACI if you select the Data Plane option.
- Step 6** Enter the following details if you have selected the Policy Plane option:
- **IP address / Host name:** Enter the IP address or hostname of the Cisco ACI server. You can enter three IP addresses or host names separated by commas.
  - **Admin name:** Enter the username of the Cisco ACI admin user.
  - **Admin password:** Enter the password of the Cisco ACI admin user.
  - **Tenant name:** Enter the name of the tenant that is configured on the Cisco ACI.
  - **L3 Route network name:** Enter the name of the Layer 3 Route network that is configured on the Cisco ACI for synchronizing the policy elements.
  - Click **Test Settings** to check the connectivity with the Cisco ACI server.
  - **New SGT Suffix:** This suffix will be added to the SGTs that are newly created based on the EPGs learnt from Cisco ACI.
- Note** The EPG name will be truncated if it is greater than 32 characters. However, you can view the full name of the EPG, application profile name, and SGT suffix details in the Description field in the Security Groups listing page.
- **New EPG Suffix:** This suffix will be added to the EPGs that are newly created in Cisco ACI based on the SGTs learnt from Cisco ISE.
  - In the **SXP Propagation** area, you can select all the SXP domains or specify the SXP domains that will share the mappings with Cisco ACI.
- Step 7** Enter the following details if you have selected the Data Plane option:
- **Propagate using SXP:** Check this check box if you want Cisco ISE to learn Endpoint (EP) data from Cisco ACI and propagate the EP data using SXP.
- Note** When you select this option, ensure that the SXP service is enabled on the deployment node (**Administration > System > Deployment**).

- **IP address/Hostname:** Enter the IP address or hostname of the Cisco ACI server. You can enter three IP addresses or host names separated by commas.
- **Admin name:** Enter the username of the Cisco ACI admin user.
- **Admin password:** Enter the password of the Cisco ACI admin user.
- **Tenant name:** Enter the name of the tenant that is configured on the Cisco ACI.
- **Test Settings:** Click this button to check the connectivity with the Cisco ACI server.
- **Max number of IEPGs:** Specify the maximum number of IEPGs that will be converted to SGTs. IEPGs are converted in alphabetical order. Default value is 1000.
- **Max number of SGTs:** Specify the maximum number of SGTs that will be converted to IEPGs. SGTs are converted in alphabetical order. Default value is 500.
- **New SGT Suffix:** This suffix will be added to the SGTs that are newly created based on the EPGs learnt from Cisco ACI.
- **New EPG Suffix:** This suffix will be added to the EPGs that are newly created in Cisco ACI based on the SGTs learnt from Cisco ISE.
- **EEPG name for untagged packets:** Cisco TrustSec packets that are not converted to an EEPG are tagged with this name in Cisco ACI.
- **Default SGT name:** Choose the default name for the SGT from the drop-down list.

**Step 8** Click **Save**.

---

## Run Top N RBACL Drops by User Report

You can run the Top N RBACL Drops by User report to see the policy violations (based on packet drops) by specific users.

---

- Step 1** Choose **Operations > Reports > TrustSec**.
  - Step 2** Click **Top N RBACL Drops by User**.
  - Step 3** From the **Filters** drop-down menu, add the required monitor modes.
  - Step 4** Enter the values for the selected parameters accordingly. You can specify the mode from the Enforcement mode drop-down list as Enforce, Monitor, or Both.
  - Step 5** From the **Time Range** drop-down menu, choose a time period over which the report data will be collected.
  - Step 6** Click **Run** to run the report for a specific period, along with the selected parameters.
-



## PART VI

# Monitoring and Troubleshooting Cisco ISE

- [Monitoring and Troubleshooting, on page 841](#)
- [Reports, on page 897](#)





## CHAPTER 28

# Monitoring and Troubleshooting

- [Monitoring and Troubleshooting Service in Cisco ISE, on page 841](#)
- [Device Configuration for Monitoring, on page 845](#)
- [Troubleshooting the Cisco AnyConnect Agent Download Issues, on page 845](#)
- [Troubleshooting the Profiler Feed, on page 846](#)
- [Posture Compliance, on page 846](#)
- [SNMP Traps to Monitor Cisco ISE, on page 847](#)
- [Cisco ISE Alarms, on page 851](#)
- [Log Collection, on page 871](#)
- [Live Authentications, on page 872](#)
- [Global Search for Endpoints, on page 873](#)
- [Session Trace for an Endpoint, on page 875](#)
- [Authentication Summary Report, on page 877](#)
- [Diagnostic Troubleshooting Tools, on page 878](#)
- [Session Trace Test Cases, on page 880](#)
- [Technical Support Tunnel for Advanced Troubleshooting, on page 882](#)
- [TCP Dump Utility to Validate Incoming Traffic, on page 883](#)
- [Download Endpoint Statistical Data from MnT Nodes, on page 887](#)
- [Obtaining Additional Troubleshooting Information, on page 887](#)
- [Monitoring Database, on page 892](#)
- [Database Crash or File Corruption Issues , on page 895](#)

## Monitoring and Troubleshooting Service in Cisco ISE

The Monitoring and Troubleshooting (MnT) service is a comprehensive identity solution for all Cisco ISE run-time services. The **Operations** menu contains the following components, and can be viewed only from the primary Policy Administration Node (PAN). Note that the **Operations** menu does not appear in the primary Monitoring node.

- **Monitoring:** Provides real-time presentation of meaningful data representing the state of access activities on a network. This insight allows you to easily interpret and monitor operational conditions.
- **Troubleshooting:** Provides contextual guidance for resolving access issues on networks. You can then address user concerns and provide resolution in a timely manner.

- **Reporting:** Provides a catalog of standard reports that you can use to analyze trends and monitor system performance and network activities. You can customize reports in various ways and save them for future use. You can search records using wild cards and multiple values in all the reports for the **Identity**, **Endpoint ID**, and **ISE Node** (except the **Health Summary** report) fields.

#### [ISE Community Resource](#)

For a complete list of troubleshooting TechNotes, see [ISE Troubleshooting TechNotes](#).

## Cisco ISE Dashboard

The Cisco ISE dashboard or home page (**Home > Summary**) is the landing page that you view after you log in to the Cisco ISE administration portal. The dashboard is a centralized management console consisting of metric meters along the top of the window, with dashlets below. The default dashboards are **Summary**, **Endpoints**, **Guests**, **Vulnerability**, and **Threat**.



**Note** You can view this dashboard data only in the Cisco ISE primary PAN portal.

The dashboard's real-time data provides an at-a-glance status of the devices and users accessing your network, and an overview of the system's health.



**Note** You must install Adobe Flash Player to be able to view the dashlets and all the corresponding drill-down windows.

Click the gear icon in the second level menu bar for a drop-down list of dashboard settings. The following table contains descriptions for the dashboard settings options available in the drop-down list:

Drop-Down List Option	Description
<b>Add New Dashboard</b>	You can have a maximum of 20 dashboards, including the five default dashboards.
<b>Rename Dashboard</b>	(This option is available only for custom dashboards) To rename a dashboard: <ol style="list-style-type: none"> <li>1. Click <b>Rename Dashboard</b>.</li> <li>2. Specify a new name.</li> <li>3. Click <b>Apply</b>.</li> </ol>

Drop-Down List Option	Description
<b>Add Dashlet</b>	<p>To add a dashlet to the home page dashboard:</p> <ol style="list-style-type: none"> <li>1. Click <b>Add Dashlet(s)</b>.</li> <li>2. In the <b>Add Dashlets</b> window, click <b>Add</b> next to the dashlets that you want to add.</li> <li>3. Click <b>Save</b>.</li> </ol> <p><b>Note</b> You can add a maximum of nine dashlets per dashboard.</p>
<b>Export</b>	<p>You can export the dashboard data as a PDF or a CSV file.</p> <ol style="list-style-type: none"> <li>1. Click <b>Export</b>.</li> <li>2. In the <b>Export</b> dialog box, click the radio button next to one of the following file formats: <ul style="list-style-type: none"> <li>• <b>PDF</b>: Choose the PDF format for a snapshot view of the selected dashlets.</li> <li>• <b>CSV</b>: Choose the CSV format to download the selected dashboard data as a zip file.</li> </ul> </li> <li>3. In the <b>Export</b> dialog box, check the check boxes next to the dashlets you want to export.</li> <li>4. Click <b>Export</b>.</li> </ol> <p>The zip file contains individual dashlet CSV files for the selected dashboard. Data related to each tab in a dashlet is displayed as separate sections in the corresponding dashlet CSV file.</p> <p>When you export a custom dashboard, the zip file is exported with the same name. For example, if you export a custom dashboard that is named MyDashboard, then the exported file's name is MyDashboard.zip.</p>
<b>Layout Template</b>	<p>You can change the layout of the template in which the dashlets are displayed.</p> <p>To change the layout:</p> <ol style="list-style-type: none"> <li>1. Click <b>Layout Template</b>.</li> <li>2. Select the required layout from the options available.</li> </ol>

Drop-Down List Option	Description
Manage Dashboards	<p>Click <b>Manage Dashboards</b> and choose one of the following options:</p> <ul style="list-style-type: none"> <li>• <b>Mark as Default Dashboard:</b> Use this option to set a dashboard as your default dashboard (the home page).</li> <li>• <b>Reset all Dashboards:</b> Use this option to reset all the dashboards to their original settings.</li> </ul>

You can delete a dashboard that you have created by clicking the close (x) icon next to the corresponding custom dashboard.



**Note** You cannot rename or delete a default dashboard.

Each dashlet has a toolbar at the top-right corner where you can perform the following operations:

- **Detach:** To view a dashlet in a separate window.
- **Refresh:** To refresh a dashlet.
- **Remove:** To remove a dashlet from the dashboard.

You can drag and drop the dashlet using the gripper icon that is present at the top-left corner of the dashlet.

The Alarms dashlet contains a quick filter for the **Severity** column. You can filter alarms by their severity by choosing **Critical**, **Warning**, or **Info** from the **Severity** drop-down list.

## Network Privilege Framework Event Flow Process

The Network Privilege Framework (NPF) authentication and authorization event flow uses the process described in the following table:

Process Stage	Description
1	Network Access Device (NAD) performs either a normal authorization or a flex authorization.
2	An unknown agentless identity is profiled with web authorization.
3	A RADIUS server authenticates and authorizes the identity.
4	Authorization is provisioned for the identity at the port.
5	Unauthorized endpoint traffic is dropped.



## User Roles and Permissions for Monitoring and Troubleshooting Capabilities

Monitoring and troubleshooting capabilities are associated with default user roles. The tasks you are allowed to perform are directly related to your assigned user role.

See [Cisco ISE Administrator Groups, on page 99](#) for information on the permissions and restrictions set for each user role.



---

**Note** Accessing Cisco ISE using the root shell without Cisco TAC supervision is not supported, and Cisco is not responsible for any service disruption that might be caused as a result.

---

## Data Stored in the Monitoring Database

The Cisco ISE monitoring service collects and stores data in a specialized monitoring database. The rate and amount of data utilized to monitor network functions may require a node dedicated solely to monitoring. If your Cisco ISE network collects logging data at a high rate from policy service nodes or network devices, we recommend a Cisco ISE node dedicated to monitoring.

To manage the information stored in the monitoring database, perform full and incremental backups of the database. This includes purging unwanted data and then restoring the database.

### Related Topics

[Monitoring Database](#), on page 892

## Device Configuration for Monitoring

The MnT node receives and uses data from the devices on a network to populate the dashboard display. To enable communication between the MnT node and the network devices, the switches and NADs must be configured properly.

## Troubleshooting the Cisco AnyConnect Agent Download Issues

If a Policy Service Node (PSN) goes down during network setup assistance while downloading Cisco AnyConnect, redownload the AnyConnect agent from the client provisioning portal and run the complete flow again.



---

**Note** Cisco ISE does not support ARM64 version of AnyConnect for AnyConnect posture flow. Ensure that you do not use the ARM64 version of AnyConnect in the client provisioning policy, otherwise it might cause failure on the client side. Restart the client if Anyconnect is not working properly because of this issue.

---

## Troubleshooting the Profiler Feed

The **Test Feed Service Connection** button on **Administration > Feed Service > Profiler** verifies that there is a connection to the Cisco feed server, and that the certificate is valid.

If the test is able to connect to the Cisco feed server, a pop-up window is displayed with a message stating that the test connection is successful.

If the connection fails, the area adjacent to the **Test Feed Service Connection** button displays a response from the server, which is similar to the following example in which the important part of the message is in bold:

```
Test result: Failure: FeedService test connection failed : Feed Service unavailable :
SocketTimeoutException invoking https://ise.cisco.com:8443/feedserver/feed/serverinfo:
sun.security.validator.ValidatorException:PKIX path building failed:
Sun.security.provider.certpath.SunCertPathBuilderException Unable to find valid certification
path to requested target
```

Here are some possible error messages, and the corresponding actions to be taken:

- `Unable to find valid certification path to requested target`: This message indicates that the certificate that the feed server used is not valid. Verify that you have enabled the Verisign certificates.
- `No route to host`: Verify that you have a working connection to an outside network from the Cisco ISE server.
- `UnknownHostException` (at the beginning of an error message): Verify that you have a working connection to an outside network from the Cisco ISE server.

## Posture Compliance

The **Posture Compliance** dashlet provides information about the users who are accessing the network, and whether they are posture compliant. The data that is displayed is for devices that are currently connected to the network. The stack bars show noncompliance statistics, and are arranged according to the operating system and other criteria. Spark lines represent the percentage of compliant versus noncompliant posture attempts.

### Check Posture Compliance

- 
- Step 1** Log in to Cisco ISE and access the dashboard.
- Step 2** In the **Posture Compliance** dashlet, hover your cursor over a stack bar or sparkline.  
A tooltip provides detailed information.
- Step 3** Expand the data categories for more information.
- Step 4** Expand the **Posture Compliance** dashlet.  
A detailed real-time report is displayed.

**Note** You can view the posture compliance report in the **Context Visibility** window. Navigate **Context Visibility > Endpoints > Compliance**. This window displays different charts based on **Compliance Status**, **Location**, **Endpoints**, and **Applications by Categories**.

You might see the posture status for endpoints that do not have any active sessions. For example, if the last known posture status for an endpoint is **Compliant**, the status remains **Compliant** in the **Context Visibility** window until the next update is received for the endpoint, even if the endpoint session is terminated. The posture status is retained in the **Context Visibility** window until that endpoint is deleted or purged.

## SNMP Traps to Monitor Cisco ISE

SNMP traps help you to monitor the status of Cisco ISE. If you want to monitor Cisco ISE without accessing the Cisco ISE server, you can configure a MIB browser as an SNMP host in Cisco ISE. You can then monitor the status of Cisco ISE from the MIB browser.

See the [Cisco Identity Services Engine CLI Reference Guide](#) for information on the **snmp-server host** and **snmp-server trap** commands.

Cisco ISE supports SNMPv1, SNMPv2c, and SNMPv3.

Cisco ISE sends the following generic system traps if you configure the SNMP host from the CLI:

- Cold start: When the device reboots.
- Linkup: When Ethernet interface is up.
- Linkdown: When Ethernet interface is down.
- Authentication failure: When the community strings do not match.

The following table lists the generic SNMP traps that are generated by default in Cisco ISE.

OID	Description	Trap Example
.1.3.6.1.4.1.8072.4.0.3 \n NET-SNMP-AGENT-MIB::nsNotifyRestart	Indicates that the agent has been restarted.	DISMAN-EVENT-MIB::sysUpTimeInstance = Timeticks: (478) 0:00:04.78 SNMPv2-MIB::snmpTrapOID.0 = OID: NET-SNMP-AGENT-MIB::nsNotifyRestart SNMPv2-MIB::snmpTrapEnterprise.0 = OID: NET-SNMP-MIB::netSnmNotificationPrefix
.1.3.6.1.4.1.8072.4.0.2 \n NET-SNMP-AGENT-MIB::nsNotifyShutdown	Indicates that the agent is in the process of being shut down.	DISMAN-EVENT-MIB::sysUpTimeInstance = Timeticks: (479) 0:00:04.79 SNMPv2-MIB::snmpTrapOID.0 = OID: NET-SNMP-AGENT-MIB::nsNotifyShutdown SNMPv2-MIB::snmpTrapEnterprise.0 = OID: NET-SNMP-MIB::netSnmNotificationPrefix

OID	Description	Trap Example
.1.3.6.1.6.3.1.1.5.4 \n IF-MIB::linkUp	Signifies that the SNMP entity, acting in an agent role, has detected that the ifOperStatus object for one of its communication links left the Down state and transitioned into some other state (but not into the notPresent state). This other state is indicated by the included value of ifOperStatus.	DISMAN-EVENT-MIB::sysUpTimeInstance = Timeticks: (478) 0:00:04.78 SNMPv2-MIB::snmpTrapOID.0 = OID: IF-MIB::linkUp IF-MIB::ifIndex.12 = INTEGER: 12 IF-MIB::ifAdminStatus.12 = INTEGER: up(1) IF-MIB::ifOperStatus.12 = INTEGER: up(1) SNMPv2-MIB::snmpTrapEnterprise.0 = OID: NET-SNMP-MIB::netSnmpAgentOIDs.10

OID	Description	Trap Example
.1.3.6.1.6.3.1.1.5.3 \n IF-MIB::linkDown	Signifies that the SNMP entity, acting in an agent role, has detected that the ifOperStatus object for one of its communication links is about to enter the Down state from some other state (but not from the notPresent state). This other state is indicated by the included value of ifOperStatus.	DISMAN-EVENT-MIB::sysUpTimeInstance = Timeticks: (479) 0:00:04.79 SNMPv2-MIB::snmpTrapOID.0 = OID: IF-MIB::linkDown IF-MIB::ifIndex.5 = INTEGER: 5 IF-MIB::ifAdminStatus.5 = INTEGER: up(1) IF-MIB::ifOperStatus.5 = INTEGER: down(2) SNMPv2-MIB::snmpTrapEnterprise.0 = OID: NET-SNMP-MIB::netSnmpAgentOIDs.10
.1.3.6.1.6.3.1.1.5.1 \n SNMPv2-MIB::coldStart	Signifies that the SNMP entity, supporting a notification originator application, is reinitializing itself and that its configuration may have been altered.	DISMAN-EVENT-MIB::sysUpTimeInstance = Timeticks: (8) 0:00:00.08 SNMPv2-MIB::snmpTrapOID.0 = OID: SNMPv2-MIB::coldStart SNMPv2-MIB::snmpTrapEnterprise.0 = OID: NET-SNMP-MIB::netSnmpAgentOIDs.10

### Process-Monitoring SNMP Traps in Cisco ISE

Cisco ISE allows you to send hrSWRunName traps for Cisco ISE process statuses to the SNMP manager if you configure an SNMP host from the Cisco ISE CLI. Cisco ISE uses a cron job to trigger these traps. The cron job retrieves the Cisco ISE process status from Monit. After you configure the **SNMP-Server Host** command from the CLI, a cron job runs every five minutes and monitors Cisco ISE.



**Note** When an ISE process is manually stopped by an admin, Monit for the process also stops and no traps are sent to the SNMP manager. A process-stop SNMP trap is sent to the SNMP manager only when a process accidentally shuts down and is not automatically revived.

The following is a list of process-monitoring SNMP traps in Cisco ISE.

OID	Description	Trap Example
.1.3.6.1.2.1.25.4.2.1.2 \n HOST-RESOURCES-MIB::hrSWRunName	A textual description of this running piece of software, including the manufacturer, revision, and the name by which it is commonly known. If this software was installed locally, this must be the same string as that used in the corresponding hrSWInstalledName. The services considered are app-server, rsyslog, redis-server, ad-connector, mnt-collector, mnt-processor, ca-server est-server, and elasticsearch.	DISMAN-EVENT-MIB::sysUpTimeInstance = Timeticks: (63692139) 7 days, 8:55:21.39 SNMPv2-MIB::snmpTrapOID.0 = OID: HOSTRESOURCES- MIB::hrSWRunName HOSTRESOURCES- MIB::hrSWRunName = STRING: "redis-server:Running"

Cisco ISE sends traps for the following statuses to the configured SNMP server:

- Process Start (monitored state)
- Process Stop (not monitored state)
- Execution Failed: When the process state changes from Monitored to Execution Failed, a trap is sent.
- Does Not Exist: When the process state changes from Monitored to Does Not Exist, a trap is sent.

A unique object ID (OID) is generated for every object in the SNMP server and a value is assigned to the OID. You can find the object with its OID value in the SNMP server. The OID value for a running trap is *running*, and the OID value for the Not monitored, Does not exist, and Execution failed traps is *stopped*.

Cisco ISE sends traps using the OID of hrSWRunName that belongs to the HOST-RESOURCES MIB, and sets the OID value as < *PROCESS NAME* > - < *PROCESS STATUS* >, for example, runtime - running.

To stop Cisco ISE from sending SNMP traps to the SNMP server, remove the SNMP configuration from the Cisco ISE CLI. This operation stops sending SNMP traps and polling from the SNMP manager.

### Disk Utilization SNMP Traps in Cisco ISE

When a Cisco ISE partition reaches its threshold disk utilization limit and the configured amount of free space is reached, the disk utilization trap is sent.



**Note** Cisco ISE does not have any MIB for process status or disk utilization. Cisco ISE uses OID HOST-RESOURCES-MIB::hrSWRunName for sending SNMP trap. You cannot use SNMP walk or SNMP get command to query the process status or disk utilization.

The following is a list of disk utilization SNMP traps that can be configured in Cisco ISE:

OID	Description	Trap Example
.1.3.6.1.4.1.2021.9.1.9 \n UCD-SNMP-MIB::dskPercent	Percentage of space used in the disk.	DISMAN-EVENT-MIB::sysUpTimeInstance = Timeticks: (118198297) 13 days, 16:19:42.97 SNMPv2-MIB::snmpTrapOID.0 = OID: UCD-SNMP-MIB::dskPercent UCD-SNMP-MIB::dskPercent = INTEGER: 13
.1.3.6.1.4.1.2021.9.1.2 \n UCD-SNMP-MIB::dskPath	Path where the disk is mounted.  dskPath can send traps for all the mount points in the output of the ISE admin command <b>show disks</b> .	DISMAN-EVENT-MIB::sysUpTimeInstance = Timeticks: (118198304) 13 days, 16:19:43.04 SNMPv2-MIB::snmpTrapOID.0 = OID: UCD-SNMP-MIB::dskPath UCD-SNMP-MIB::dskPath = STRING: /opt

## Cisco ISE Alarms

Alarms notify you of critical conditions on a network and are displayed in the Alarms dashlet. They also provide information on system activities, such as data purge events. You can either configure how you want to be notified about system activities, or disable them entirely. You can also configure the threshold for certain alarms.

Most alarms do not have an associated schedule and are sent immediately after an event occurs. At any given point in time, only the latest 15,000 alarms are retained.

If the event recurs, the same alarms are suppressed for about an hour. During the time that the event recurs, depending on the trigger, it may take about an hour for the alarms to reappear.

The following table lists all the Cisco ISE alarms, descriptions, and their resolution.

**Table 70: Cisco ISE Alarms**

Alarm Name	Alarm Description	Alarm Resolution
Administrative and Operational Audit Management		

Alarm Name	Alarm Description	Alarm Resolution
Deployment Upgrade Failure	An upgrade has failed on an ISE node.	Check ADE.log on the failed node for upgrade failure reason and corrective actions.
Upgrade Bundle Download failure	An upgrade bundle download has failed on an ISE node.	Check ADE.log on the failed node for upgrade failure reason and corrective actions.
SXP Connection Failure	SXP connection has failed.	Verify that the SXP service is running. Check the peer for compatibility.
Cisco profile applied to all devices	Network device profiles define the capabilities of network access devices, such as MAB, Dot1X, CoA, and Web Redirect. As part of the ISE 2.0 upgrade, the default Cisco network device profile was applied to all network devices.	Consider editing the configuration of non-Cisco network devices to assign the appropriate profile.
Secure LDAP connection reconnect due to CRL found revoked certificate	CRL check result indicates that the certificate used for LDAP connection is revoked.	Check the CRL configuration and verify that it is valid. Check that the LDAP server certificate and its issuer certificates are not revoked. If revoked, issue a new certificate and install it on the LDAP server.
Secure LDAP connection reconnect due to OCSP found revoked certificate	OCSP check result indicates that the certificate used for LDAP connection is revoked.	Check the OCSP configuration and verify that it is valid. Check that the LDAP server certificate and its issuer certificates are not revoked. If revoked, issue a new certificate and install it on the LDAP server.
Secure syslog connection reconnect due to CRL found revoked certificate	CRL check result indicates that the certificate used for syslog connection is revoked.	Check the CRL configuration and verify that it is valid. Check that the syslog server certificate and its issuer certificates are not revoked. If revoked, issue a new certificate and install it on the syslog server.
Secure syslog connection reconnect due to OCSP found revoked certificate	OCSP check result indicates that the certificate used for syslog connection is revoked.	Check the OCSP configuration and verify that it is valid. Check that the syslog server certificate and its issuer certificates are not revoked. If revoked, issue a new certificate and install it on the syslog server.



Alarm Name	Alarm Description	Alarm Resolution
Administrator account Locked/Disabled	Administrator account is locked or disabled because of password expiration or incorrect login attempts. For more details, refer to the administrator password policy.	Administrator password can be reset by another administrator using the GUI or CLI.
ERS identified deprecated URL	ERS-identified deprecated URL	The request URL is deprecated and we recommend that you avoid using it.
ERS identified out-dated URL	ERS-identified outdated URL	The requested URL is outdated and we recommend that you use a newer one. The outdated URL will not be removed in future releases.
ERS request content-type header is outdated	ERS request content-type header is outdated.	The request resource version stated in the request content-type header is outdated. This means that the resource schema has been modified. One or more attributes may have been added or removed. To overcome that with the outdated schema, the ERS engine will use default values.
ERS XML input is a suspect for XSS or Injection attack	ERS XML input is a suspect for XSS or injection attack.	Review your XML input.
Backup Failed	The ISE backup operation failed.	Check the network connectivity between Cisco ISE and the repository. Ensure that: <ul style="list-style-type: none"> <li>• The credentials used for the repository are correct.</li> <li>• There is sufficient disk space in the repository.</li> <li>• The repository user has write privileges.</li> </ul>
CA Server is down	CA server is down.	Check to make sure that the CA services are up and running on the CA server.
CA Server is Up	CA server is up.	A notification is issued to inform the administrator that the CA server is up.

Alarm Name	Alarm Description	Alarm Resolution
Certificate Expiration	This certificate will expire soon. When it expires, Cisco ISE may fail to establish secure communication with clients.	Replace the certificate. For a trust certificate, contact the issuing Certificate Authority (CA). For a CA-signed local certificate, generate a CSR and have the CA create a new certificate. For a self-signed local certificate, use Cisco ISE to extend the expiration date. You can delete the certificate if it is no longer used.
Certificate Revoked	Administrator has revoked the certificate issued to an endpoint by the internal CA.	Go through the BYOD flow again from the start to be provisioned with a new certificate.
Certificate Provisioning Initialization Error	Certificate provisioning initialization failed.	More than one certificate found with the same value of CN (CommonName) attribute in the subject. Cannot build certificate chain. Check all the certificates in the system, including those from the SCEP (Simple Certificate Enrollment Protocol) server.
Certificate Replication Failed	Certificate replication to secondary node failed.	The certificate is not valid on the secondary node, or there is some other permanent error condition. Check the secondary node for a pre-existing, conflicting certificate. If found, delete the pre-existing certificate on the secondary node, and export the new certificate on the primary node, delete it, and import it in order to reattempt replication.
Certificate Replication Temporarily Failed	Certificate replication to secondary node temporarily failed.	The certificate was not replicated to a secondary node because of a temporary condition such as a network outage. The replication is retried until it succeeds.

Alarm Name	Alarm Description	Alarm Resolution
Certificate Expired	This certificate has expired. Cisco ISE may fail to establish secure communication with clients. Node-to-node communication may also be affected.	Replace the certificate. For a trust certificate, contact the issuing Certificate Authority (CA). For a CA-signed local certificate, generate a CSR and have the CA create a new certificate. For a self-signed local certificate, use Cisco ISE to extend the expiration date. You can delete the certificate if it is no longer used.
Certificate Request Forwarding Failed	Certificate request forwarding failed.	Make sure that the certificate request that is coming in matches the attributes from the sender.
Configuration Changed	Cisco ISE configuration is updated. This alarm is not triggered for any configuration change in users and endpoints.	Check if the configuration change is expected.
CRL Retrieval Failed	Unable to retrieve CRL from the server. This occurs if the specified CRL is unavailable.	Ensure that the download URL is correct and is available for the service.
DNS Resolution Failure	DNS resolution failed on the node.	Check if the DNS server configured by the <b>ip name-server</b> command is reachable.  If you get the alarm as <b>DNS Resolution failed for CNAME &lt;hostname of the node&gt;</b> , ensure that you create CNAME RR along with the A record for each Cisco ISE node.
Firmware Update Required	A firmware update is required on this host.	Contact Cisco TAC to obtain firmware update.
Insufficient Virtual Machine Resources	Virtual Machine (VM) resources such as CPU, RAM, disk space, or IOPS (Input/output operations per second) are insufficient on this host.	Ensure that the minimum requirements for the VM host, as specified in the <i>Cisco ISE Hardware Installation Guide</i> .

Alarm Name	Alarm Description	Alarm Resolution
NTP Service Failure	The NTP service is down on this node.	This could be because there is a large time difference between the NTP server and a Cisco ISE node (more than 1000 seconds). Ensure that your NTP server is working properly and use the <b>ntp server &lt;servername&gt;</b> CLI command to restart the NTP service and fix the time gap.
NTP Sync Failure	All the NTP servers configured on this node are unreachable.	Run the <b>show ntp</b> command from the CLI for troubleshooting. Ensure that the NTP servers are reachable from Cisco ISE. If NTP authentication is configured, ensure that the key ID and value matches with that of the server.
No Configuration Backup Scheduled	No Cisco ISE configuration backup is scheduled.	Create a schedule for configuration backup.
Operations DB Purge Failed	Unable to purge older data from the operations database. This occurs if the MnT nodes are busy.	Check the Data Purging Audit report and ensure that the used space is lesser than the threshold space. Log in to the MnT nodes using the CLI and perform the purge operation manually.
Profiler SNMP Request Failure	Either the SNMP request timed out, or the SNMP community or user authentication data is incorrect.	Ensure that SNMP is running on the NAD and verify that SNMP configuration on Cisco ISE matches with NAD.
Replication Failed	The secondary node failed to consume the replicated message.	Log in to the Cisco ISE GUI and perform a manual synchronization from the <b>Deployment</b> window. Deregister and register back the affected Cisco ISE node.
Restore Failed	Cisco ISE restore operation failed.	Ensure network connectivity between Cisco ISE and the repository. Ensure that the credentials used for the repository is correct. Also ensure that the backup file is not corrupted. Execute the <b>reset-config</b> command from the CLI and restore the last-known good backup.
Patch Failure	A patch process has failed on the server.	Reinstall the patch process on the server.

Alarm Name	Alarm Description	Alarm Resolution
Patch Success	A patch process has succeeded on the server.	—
External MDM Server API Version Mismatch	External MDM server API version does not match with what is configured in Cisco ISE.	Ensure that the MDM server API version is the same as what is configured in Cisco ISE. Update the Cisco ISE MDM server configuration, if needed.
External MDM Server Connection Failure	Connection to the external MDM server failed.	Ensure that the MDM server is up and the Cisco ISE-MDM API service is running on the MDM server.
External MDM Server Response Error	External MDM server response error.	Ensure that the Cisco ISE-MDM API service is running properly on the MDM server.
Replication Stopped	ISE node could not replicate configuration data from the PAN.	Log in to the Cisco ISE GUI to perform a manual synchronization from the <b>Deployment</b> window or deregister and register back the affected ISE node with the required field.
MDM Compliance Polling Disabled	Periodic compliance polling received huge non-compliance device information.	Keep the number of non-compliant device requests reaching the MDM server below 20000.
Endpoint certificates expired	Endpoint certificates were marked expired by daily the scheduled job.	Re-enroll the endpoint device to get a new endpoint certificate.
Endpoint certificates purged	Expired endpoint certificates were purged by the daily scheduled job.	No action is needed. This is an administrator-initiated clean-up operation.
Endpoints Purge Activities	Purge the activities on endpoints for the past 24 hours. This alarm is triggered at midnight.	Review the purge activities by choosing <b>Operations &gt; Reports &gt; Endpoints and Users &gt; Endpoint Purge Activities</b> .
Slow Replication Error	Slow or a stuck replication is detected.	Verify that the node is reachable and is a part of the deployment.
Slow Replication Info	Slow or stuck replication is detected.	Verify that the node is reachable and is part of the deployment.
Slow Replication Warning	Slow or a stuck replication is detected.	Verify that the node is reachable and part of the deployment.
PAN Auto Failover - Failover Failed	Promotion request to the Secondary Administration Node failed.	See the alarm details for further action.

Alarm Name	Alarm Description	Alarm Resolution
PAN Auto Failover - Failover Triggered	Successfully triggered the failover of the Secondary Administration Node to Primary role.	Wait for the promotion of secondary PAN to complete, and bring up the old primary PAN.
PAN Auto Failover - Health Check Inactivity	PAN did not receive the health check monitoring request from the designated monitoring node.	Verify if the reported monitoring node is down or out-of-sync, and trigger a manual synchronization, if needed.
PAN Auto Failover - Invalid Health Check	Invalid health check monitoring request received for auto failover.	Verify if the health check monitoring node is out-of-sync, and trigger a manual synchronization if needed.
PAN Auto Failover - Primary Administration Node Down	PAN is down or is not reachable from the monitoring node.	Bring up the PAN, or wait for failover to happen.
PAN Auto Failover - Rejected Failover Attempt	Secondary administration node rejected the promotion request made by the health check monitor node.	See the alarm details for further action.
EST Service is down	EST service is down.	Make sure that the CA and EST services are up and running, and that the certificate services endpoint sub CA certificate chain is complete.
EST Service is up	EST service is up.	A notification is sent to inform the administrator that the EST service is up.
Smart Call Home Communication Failure	Smart Call Home messages were not sent successfully.	Ensure that there is network connectivity between Cisco ISE and Cisco Systems.
Telemetry Communication Failure	Telemetry messages were not sent successfully.	Ensure that there is network connectivity between Cisco ISE and Cisco Systems.
Adapter not reachable	Cisco ISE cannot connect to the adapter.	Check the adapter logs for more details about the failure.
Adapter Error	Adapter has encountered an error.	Check the description of the alarm.
Adapter Connection Failed	The adapter cannot connect to the source server.	Ensure that the source server is reachable.

Alarm Name	Alarm Description	Alarm Resolution
Adapter Stopped Due to Error	The adapter has encountered an error and is not in the desired state.	Ensure that the adapter configuration is correct and the source server is reachable. See the adapter logs for more details about the error.
Service Component Error	The service component has encountered an error.	Check the description of the alarm.
Service Component Info	The service component has sent a notification.	None.
ISE Services		
Excessive TACACS Authentication Attempts	The ISE Policy Service nodes are experiencing higher than expected rate of TACACS authentications.	<ul style="list-style-type: none"> <li>• Check the re-auth timer in the network devices.</li> <li>• Check the network connectivity of the ISE infrastructure.</li> </ul>
Excessive TACACS Authentication Failed Attempts	The ISE Policy Service nodes are experiencing higher than expected rate of failed TACACS authentications.	<ul style="list-style-type: none"> <li>• Check the authentication steps to identify the root cause.</li> <li>• Check the ISE or NAD configuration for Identity and Secret mismatch.</li> </ul>
MSE Location Server accessible again	MSE Location Server is accessible again.	None.
MSE Location Server not accessible.	MSE Location Server is not accessible, or is down.	Check if the MSE Location Server is up and running and is accessible from the ISE nodes.
AD Connector had to be restarted	AD Connector stopped unexpectedly and had to be restarted.	If this issue persists, contact Cisco TAC for assistance.
Active Directory Forest is unavailable	Active Directory forest Global Catalog is unavailable, and cannot be used for authentication, authorization, and group and attribute retrieval.	Check DNS configuration, Kerberos configuration, error conditions, and network connectivity.
Authentication domain is unavailable	Authentication domain is unavailable, and cannot be used for authentication, authorization and group and attribute retrieval.	Check DNS configuration, Kerberos configuration, error conditions, and network connectivity.

Alarm Name	Alarm Description	Alarm Resolution
ISE Authentication Inactivity	Cisco ISE policy service nodes are not receiving authentication requests from the network devices.	<ul style="list-style-type: none"> <li>• Check the Cisco ISE and NAD configuration.</li> <li>• Check the network connectivity of the Cisco ISE and NAD infrastructure.</li> </ul>
ID Map. Authentication Inactivity	No user authentication events were collected by the Identity Mapping Service in the last 15 minutes.	If user authentications are expected during this time, for example, during work hours, check the connection to the Active Directory domain controllers.
CoA Failed	Network device has denied the Change of Authorization (CoA) request issued by the Cisco ISE policy service nodes.	Ensure that the network device is configured to accept CoA from Cisco ISE. Check if CoA is issued on a valid session.
Configured nameserver is down	Configured nameserver is down or unavailable.	Check DNS configuration and network connectivity.
Supplicant Stopped Responding	Cisco ISE sent last message to the client 120 seconds ago, but there is no response from the client.	<ul style="list-style-type: none"> <li>• Verify that the supplicant is configured properly to conduct a full EAP conversation with Cisco ISE.</li> <li>• Verify that NAS is configured properly to transfer EAP messages to and from the supplicant.</li> <li>• Verify that the supplicant or NAS does not have a short timeout for EAP conversation.</li> </ul>
Excessive Authentication Attempts	Cisco ISE policy service nodes are experiencing higher than expected rate of authentications.	<p>Check the reauthorization timer in the network devices. Check the network connectivity of the Cisco ISE infrastructure.</p> <p>After the threshold is met, the Excessive Authentication Attempts and Excessive Failed Attempts alarms are triggered. The numbers displayed next to the <b>Description</b> column are the total number of authentications that have succeeded or failed against Cisco ISE in the last 15 minutes.</p>



Alarm Name	Alarm Description	Alarm Resolution
Excessive Failed Attempts	Cisco ISE policy service nodes are experiencing higher than expected rate of failed authentications.	Check the authentication steps to identify the root cause. Check the Cisco ISE or NAD configuration for identity and secret mismatch.  After the threshold is met, the Excessive Authentication Attempts and Excessive Failed Attempts alarms are triggered. The numbers displayed next to the <b>Description</b> column are the total number of authentications that have succeeded or failed against Cisco ISE in the last 15 minutes.
AD: Machine TGT refresh failed	ISE server Ticket Granting Ticket (TGT) refresh has failed. The TGT is used for Active Directory connectivity and services.	Check that the ISE machine account exists and is valid. Also check for possible clock skew, replication, Kerberos configuration, or network errors, or all of them.
AD: ISE account password update failed	ISE server has failed to update its AD machine account password.	Check that the ISE machine account password is not changed and that the machine account is not disabled or restricted. Check the connectivity to KDC.
Joined domain is unavailable	Joined domain is unavailable, and cannot be used for authentication, authorization, and group and attribute retrieval.	Check DNS configuration, Kerberos configuration, error conditions, and network connectivity.
Identity Store Unavailable	Cisco ISE policy service nodes are unable to reach the configured identity stores.	Check the network connectivity between Cisco ISE and the identity stores.
Misconfigured Network Device Detected	Cisco ISE has detected too many RADIUS accounting information from NAS.	Too much duplicate RADIUS accounting information has been sent to ISE from NAS. Configure NAS with accurate accounting frequency.
Misconfigured Supplicant Detected	Cisco ISE has detected misconfigured supplicant on the network.	Ensure that the configuration on the supplicant is correct.
No Accounting Start	Cisco ISE policy service nodes have authorized a session, but did not receive accounting start from the network device.	Ensure that RADIUS accounting is configured on the network device. Check the network device configuration for local authorization.

Alarm Name	Alarm Description	Alarm Resolution
Unknown NAD	Cisco ISE policy service nodes are receiving authentication requests from a network device that is not configured in Cisco ISE.	Check if the network device is a genuine request and add it to the configuration. Ensure that the secret matches.
SGACL Drops	Secure Group Access (SGACL) drops occurred. This occurs if a Trustsec-capable device drops packets because of SGACL policy violations.	Run the RBACL drop summary report and review the source causing the SGACL drops. Issue a CoA to the offending source to reauthorize or disconnect the session.
RADIUS Request Dropped	The authentication and accounting request from a NAD is silently discarded. This may occur because of unknown NAD, mismatched shared secrets, or invalid packet content per RFC.	Check that the NAD/AAA client has a valid configuration in Cisco ISE. Check whether the shared secrets on the NAD/AAA client and Cisco ISE match each other. Ensure that the AAA client and the network device, have no hardware problems or problems with RADIUS compatibility. Also, ensure that the network that connects the device to Cisco ISE has no hardware problems.
EAP Session Allocation Failed	A RADIUS request was dropped because EAP sessions limit is reached. This condition can be caused by too many parallel EAP authentication requests.	Wait for a few seconds before invoking another RADIUS request with a new EAP session. If system overload continues to occur, try restarting the ISE server.
RADIUS Context Allocation Failed	A RADIUS request was dropped due to system overload. This condition can be caused by too many parallel authentication requests.	Wait for a few seconds before invoking a new RADIUS request. If system overload continues to occur, try restarting the ISE server.
AD: ISE machine account does not have the required privileges to fetch groups	Cisco ISE machine account does not have the required privileges to fetch groups.	Check if the Cisco ISE machine account has rights to fetch user groups in the Active Directory.
Posture Configuration Detection	The posture state synchronization port is not blocked for compliant authorization profiles.	Configure an ACL to block the posture state synchronization probe from reaching Cisco ISE if the client posture status is compliant.
System Health		

Alarm Name	Alarm Description	Alarm Resolution
High Disk I/O Utilization	Cisco ISE system is experiencing high disk I/O utilization.	Check if the system has sufficient resources. Check the actual amount of work on the system, for example, number of authentications, profiler activity, and so on. Add an additional server to distribute the load.
High Disk Space Utilization	Cisco ISE system is experiencing high disk space utilization.	Check if the system has sufficient resources. Check the actual amount of work on the system, for example, number of authentications, profiler activity, and so on. Add an additional server to distribute the load.
High Load Average	Cisco ISE system is experiencing high load average.	<p>Check if the system has sufficient resources. Check the actual amount of work on the system, for example, number of authentications, profiler activity, and so on. Add an additional server to distribute the load.</p> <p>Do not use third-party tools to check the load average on a single CPU core because this metric would not reflect the overall system load. We recommend that you use the <b>tech top</b> command in the Cisco ISE CLI for a cumulative view of the system load.</p> <p>If the High Load Average alarm is seen against 2:00 a.m. time stamps for Primary and Secondary MnT nodes, note that CPU usage might be high due to DBMS statistics being run at that hour. CPU usage will be back to normal after the DBMS stats is complete.</p> <p>A High Load Average alarm is triggered at 1:00 a.m. every Sunday by a weekly maintenance task. This maintenance task rebuilds all the indexes that occupy more than 1 GB space. This alarm can be ignored.</p>

Alarm Name	Alarm Description	Alarm Resolution
High Memory Utilization	Cisco ISE system is experiencing high memory utilization.	<p>Check if the system has sufficient resources. Check the actual amount of work on the system, for example, number of authentications, profiler activity, and so on. Add an additional server to distribute the load.</p> <p>Do not use third-party tools to check memory utilization. We recommend that you use the <b>show memory</b> command in the Cisco ISE CLI to check memory utilization.</p> <p>In a Cisco ISE node, its operating system manages memory utilization. You must check for the available memory (instead of free memory) metric for a more reliable measure of memory utilization.</p> <p>Note that an operating system segments most of the memory in buffer or cache. If less than 90% of the total memory is displayed as used, and there is no substantial increase in swap memory, Cisco ISE memory utilization can be considered stable.</p>
High Operations DB Usage	Cisco ISE monitoring nodes are experiencing higher volume of syslog data than expected.	Check and reduce the purge configuration window for the operations data.
High Authentication Latency	Cisco ISE system is experiencing high authentication latency.	Check if the system has sufficient resources. Check the actual amount of work on the system, for example, number of authentications, profiler activity, and so on. Add an additional server to distribute the load.
Health Status Unavailable	The monitoring node has not received the health status from the Cisco ISE node.	Ensure that Cisco ISE nodes are up and running, and are able to communicate with the monitoring nodes.
Process Down	One of the Cisco ISE processes is not running.	Restart the Cisco ISE application.

Alarm Name	Alarm Description	Alarm Resolution
Profiler Queue Size Limit Reached	The ISE Profiler Queue Size Limit has been reached. Events received after reaching the queue size limit will be dropped.	Check if the system has sufficient resources, and ensure that the EndPoint attribute filter is enabled.
OCSP Transaction Threshold Reached	The OCSP transaction threshold has been reached. This alarm is triggered when the internal OCSP service transaction has reached its threshold.	Check if the system has sufficient resources.
Licensing		
License About to Expire	License installed on the Cisco ISE nodes are about to expire.	See the <b>Licensing</b> window in Cisco ISE to view the license usage.
License Expired	License installed on the Cisco ISE nodes has expired.	Contact the Cisco Accounts team to purchase new licenses.
License Violation	Cisco ISE nodes have detected that you are exceeding or are about to exceed the allowed license count.	Contact the Cisco Accounts team to purchase additional licenses.
Smart Licensing Authorization Expired	Authorization for Smart Licensing has expired.	See the <b>Cisco ISE License Administration</b> window to manually renew registration for Smart Licensing or check your network connectivity with Cisco Smart Software Manager. Contact your Cisco partner if the issue persists.
Smart Licensing Authorization Renewal Failure	Renewal of authorization with Cisco Smart Software Manager has failed.	See the <b>Cisco ISE License Administration</b> window to manually renew authorization with Cisco Smart Software Manager using the <b>Refresh</b> button in the <b>Licenses</b> table. Contact your Cisco partner if issue persists.
Smart Licensing Authorization Renewal Success	Renewal of authorization with Cisco Smart Software Manager was successful.	Send notification to inform that authorization renewal of Cisco ISE with Cisco Smart Software Manager was successful.
Smart Licensing Communication Failure	Communication of Cisco ISE with Cisco Smart Software Manager has failed.	Check your network connectivity with Cisco Smart Software Manager. Log in to Cisco Smart Software Manager or contact your Cisco partner if issue persists.

Alarm Name	Alarm Description	Alarm Resolution
Smart Licensing Communication Restored	Communication of Cisco ISE with Cisco Smart Software Manager was restored.	Send notification to inform that your network connectivity with Cisco Smart Software Manager has been restored.
Smart Licensing De-Registration Failure	Deregistration of Cisco ISE with Cisco Smart Software Manager has failed.	See the <b>Cisco ISE License Administration</b> window for additional details. Log in to Cisco Smart Software Manager or contact your Cisco partner if issue persists.
Smart Licensing De-Registration Success	Deregistration of Cisco ISE with Cisco Smart Software Manager was successful.	Send notification to inform that deregistration of Cisco ISE with Cisco Smart Software Manager was successful.
Smart Licensing Disabled	Smart Licensing is disabled on Cisco ISE, and traditional licensing is in use.	See the <b>License Administration</b> window to enable Smart Licensing again. See the Cisco ISE Admin Guide or contact your Cisco partner to learn about using Smart Licensing on Cisco ISE.
Smart Licensing Evaluation Period Expired	Evaluation period of Smart Licensing has expired.	See the <b>Cisco ISE License Administration</b> window to register Cisco ISE with Cisco Smart Software Manager.
Smart Licensing HA Role changed	High-availability role change has occurred while using Smart Licensing.	Send notification to inform that the HA role of Cisco ISE has changed.
Smart Licensing Id Certificate Expired	Smart Licensing certificate has expired.	See the <b>Cisco ISE License Administration</b> window to manually renew registration for Smart Licensing. Contact your Cisco partner if the issue persists.
Smart Licensing Id Certificate Renewal Failure	Registration renewal for Smart Licensing with Cisco Smart Software Manager has failed.	See the <b>Cisco ISE License Administration</b> window to manually renew registration for Smart Licensing. Contact your Cisco partner if the issue persists.
Smart Licensing Id Certificate Renewal Success	Registration renewal for Smart Licensing with Cisco Smart Software Manager was successful.	Send notification to inform that registration renewal with Cisco Smart Software Manager was successful.

Alarm Name	Alarm Description	Alarm Resolution
Smart Licensing Invalid Request	Invalid request was made to Cisco Smart Software Manager.	See the <b>Cisco ISE License Administration</b> window for additional details. Log in to Cisco Smart Software Manager or contact your Cisco partner if issue persists.
Smart Licensing Out of Compliance	Cisco ISE licenses are out of compliance.	See the <b>ISE License Administration</b> window for additional details. Contact your partner or Cisco account team to purchase new licenses.
Smart Licensing Registration Failure	Registration of Cisco ISE with Cisco Smart Software Manager has failed.	See the <b>ISE License Administration</b> window for additional details. Log in to Cisco Smart Software Manager or contact your Cisco partner if issue persists.
Smart Licensing Registration Successful	Registration of Cisco ISE with Cisco Smart Software Manager was successful.	Send notification to inform that registration of Cisco ISE with Cisco Smart Software Manager was successful.
System Error		
Log Collection Error	The Cisco ISE monitoring collector process is unable to continue with the audit logs generated from the policy service nodes.	This will not impact the actual functionality of the Policy Service nodes. Contact Cisco TAC for further resolution.
Scheduled Report Export Failure	Unable to copy the exported report (CSV file) to the configured repository.	Verify the configured repository. If it has been deleted, add it back. If it is not available or is not reachable, reconfigure the repository to a valid one.
TrustSec		
Unknown SGT was provisioned	Unknown SGT was provisioned.	ISE provisioned an Unknown SGT as part of the authorization flow. Unknown SGT should not be assigned as part of a known flow.
Some TrustSec network devices do not have the latest ISE IP-SGT mapping configuration	Some TrustSec network devices do not have the latest ISE IP-SGT mapping configuration.	ISE identified some network devices that have a different IP-SGT mapping sets. Use the <b>IP-SGT Mapping Deploy</b> option to update the devices.

Alarm Name	Alarm Description	Alarm Resolution
TrustSec SSH connection failed	TrustSec SSH connection failed.	ISE failed to establish SSH connection to a network device. Verify if the network device's SSH credentials in the <b>Network Device</b> window are similar to the credentials configured on the network device. Check the network device-enabled SSH connections from ISE (IP address).
TrustSec identified ISE was set to work with TLS versions other than 1.0	TrustSec-identified ISE was set to work with TLS versions other than 1.0.	TrustSec supports only TLS Version 1.0.
Trustsec PAC validation failed	Trustsec PAC validation failed.	ISE could not validate a PAC that was sent by the network device. Check the Trustsec device credentials in the <b>Network Device</b> window and in the device CLI. Make sure the device uses a valid PAC that was provisioned by the ISE server.
Trustsec environment data download failed	Trustsec environment data download has failed.	Cisco ISE has received illegal Environment Data request. Verify the following: <ul style="list-style-type: none"> <li>• PAC exists in the request, and is valid.</li> <li>• All the attributes exist in the request.</li> </ul>
TrustSec CoA message ignored	TrustSec CoA message was ignored.	Cisco ISE sent a TrustSec CoA message and did not receive a response. Verify if the network device is CoA capable. Check the network device configuration.
TrustSec default egress policy was modified	TrustSec default egress policy was modified.	Make sure it is aligned with your security policy.



**Note** Alarms are not triggered when you add users or endpoints to Cisco ISE.



## Alarm Settings

The following table describes the fields in the **Alarm Settings** window( **Administration > System > Settings > Alarm Settings > Alarm Configuration > Add**)

Field Name	Description
<b>Alarm Type</b>	Alarm type.
<b>Alarm Name</b>	Name of the alarm.
<b>Description</b>	Description for the alarm.
<b>Suggested Actions</b>	Action to be performed when the alarm is triggered.
<b>Status</b>	Enable or disable the alarm rule.
<b>Severity</b>	Select the severity level for your alarm. Valid options are: <ul style="list-style-type: none"> <li>• Critical: Indicates a critical error condition.</li> <li>• Warning: Indicates a normal but significant condition. This is the default condition.</li> <li>• Info: Indicates an informational message.</li> </ul>
<b>Send Syslog Message</b>	Send a syslog message for each system alarm that Cisco ISE generates.
<b>Enter multiple e-mails separated with comma</b>	List of e-mail addresses or ISE administrator names or both.
<b>Custom Text in Email</b>	Custom text messages that you want associated with your system alarm.

## Add Custom Alarms

Cisco ISE contains 12 default alarm types, such as High Memory Utilization and Configuration Changes. Cisco-defined system alarms are listed in the **Alarms Settings** window ( **Administration > System > Settings > Alarm Settings**). You can only edit the system alarms.

In addition to existing system alarms, you can add, edit, or delete custom alarms under the existing alarm types.

For each alarm type, you can create a maximum of five alarms. The total number of alarms is limited to 200.

In the **Alarm Configuration** tab of the **Alarm Settings** window, the **Conditions** column displays details for four alarms: High Authentication Latency, High Disk I/O Utilization, High Disk Space Utilization, and High Memory Utilization. Each of these alarms has a configurable threshold value. However, the **Conditions** column may not display details even after the threshold values are configured. In such a scenario, re-edit the relevant threshold field for the alarm to view the details in the **Conditions** column.

Perform this procedure to add an alarm.

- 
- Step 1** Choose **Administration > System > Settings > Alarm Settings**.
- Step 2** In the **Alarm Configuration** tab, click **Add**.
- Step 3** Enter the required details. See the [Alarm Settings](#) section for more information.

Based on the alarm type (High Memory Utilization, Excessive RADIUS Authentication Attempts, Excessive TACACS Authentication Attempts, and so on), additional attributes are displayed in the **Alarm Configuration** window. For example, **Object Name**, **Object Type**, and **Admin Name** fields are displayed for Configuration Change alarms. You can add multiple instances of the same alarm with different criteria.

- Step 4** Click **Submit**.
- 

## Cisco ISE Alarm Notifications and Thresholds

You can enable or disable Cisco ISE alarms and configure alarm notification behavior to notify you of critical conditions. For certain alarms, you can configure thresholds such as maximum failed attempts for the Excessive Failed Attempts alarm or maximum disk utilization for the High Disk Utilization alarm.

You can configure the notification settings on a per-alarm basis, and enter the email IDs of the users who have to be notified for each alarm (both system-defined and user-defined alarms).




---

**Note** The recipient email address specified at the alarm rule level overrides the global recipient email address setting.

---

## Enable and Configure Alarms

- 
- Step 1** Choose **Administration > System > Settings > Alarm Settings > Alarm Configuration**.
- Step 2** Select an alarm from the list of default alarms by clicking on the radio button and click **Edit**.
- Step 3** Select **Enable** or **Disable** from the **Status** drop-down list.
- Step 4** Configure alarm threshold, if applicable.
- Step 5** Click **Submit**.
- 

## Cisco ISE Alarms for Monitoring

Cisco ISE provides system alarms which notify you whenever any critical system condition occurs. Alarms that are generated by Cisco ISE are displayed in the Alarm dashlet. These notifications automatically appear in the Alarm dashlet.

The Alarm dashlet displays a list of recent alarms. From this list, you can choose which alarm's details you want to view. You can also receive notifications of alarms through e-mail and syslog messages.

## View Monitoring Alarms

---

- Step 1** Go to the Cisco ISE **Dashboard**.
- Step 2** Click on an alarm in the **Alarms** dashlet. A dialog box opens with the alarm details and a suggested action.
- Step 3** Click **Refresh** to refresh the alarms.
- Step 4** Acknowledge alarms to reduce the alarm counters (number of times an alarm is raised) by marking them as read. Select alarms for acknowledgement by checking the check boxes next to the timestamps.
- Choose **Acknowledge Selected** from the **Acknowledge** drop-down list to mark as read all the alarms currently displayed in the window. By default, 100 rows are displayed in the window. You can choose a different number of rows to be displayed, by choosing a value from the **Rows/Page** drop-down list.
- Choose **Acknowledge All** from the **Acknowledge** drop-down list to mark as read all the alarms in the list, whether or not they are currently displayed in the window.
- Note** When you check the check box next to the **Time Stamp** in the title row, all the alarms displayed in the window are selected. However, if you then uncheck a check box for one or more of the selected alarms, the select all function lapses. You will see that the check box next to the **Time Stamp** is unchecked at this point.
- Step 5** Click the **Details** link corresponding to the alarm that you select. A dialog box opens with the details corresponding to the selected alarm.
- Note** The **Details** link corresponding to the alarms that were generated prior to persona change shows no data.
- 

## Log Collection

Monitoring services collect log and configuration data, store the data, and then process it to generate reports and alarms. You can view the details of the logs that are collected from any of the servers in your deployment.

### Alarm Syslog Collection Location

If you configure monitoring functions to send alarm notifications as syslog messages, you need a syslog target to receive the notification. Alarm syslog targets are the destinations where alarm syslog messages are sent.



---

**Note** Cisco ISE monitoring requires that the logging-source interface configuration use the network access server (NAS) IP address. You must configure a switch for Cisco ISE monitoring.

---

You must also have a system that is configured as a syslog server to be able to receive syslog messages. You can create, edit, and delete alarm syslog targets.

To configure a remote logging target as an alarm target, perform this procedure.

---

- Step 1** Choose **Administration > System > Logging > Remote Logging Targets**.

- Step 2** Click **Add**.
- Step 3** In the **New Logging Target** window, submit the required details for the logging target, and check the **Include Alarms for this Target** check box.

## Live Authentications

You can monitor recent RADIUS authentications as they occur, from the **Live Authentications** window. The window displays the top ten RADIUS authentications in the last 24 hours. This section explains the functions of the **Live Authentications** window.

The **Live Authentications** window shows the live authentication entries corresponding to the authentication events as they happen. In addition to authentication entries, this window also shows the live session entries corresponding to the events. You can also drill-down a session to view a detailed report corresponding to that session.

The **Live Authentications** window provides a tabular account of recent RADIUS authentications, in the order in which they occur. The last update shown at the bottom of the **Live Authentications** window shows the date of the server, time, and timezone.



**Note** If the password attribute in an Access-Request packet is empty, an error message is triggered and the access request fails.

When a single endpoint is authenticated successfully, two entries appear in the **Live Authentications** window—one corresponding to the authentication record and another corresponding to the session record (pulled from the session live view). Subsequently, when the device performs another successful authentication, the repeat counter corresponding to the session record is incremented. The Repeat Counter that appears in the **Live Authentications** window shows the number of duplicate RADIUS authentication success messages that are suppressed.

See the Live Authentication data categories that are shown by default. These are described in the Recent RADIUS Authentications section.

You can choose to view all the columns, or only selected data columns. After selecting the columns that you want to be displayed, you can save your selections.

## Monitor Live Authentications

- Step 1** Choose **Operations > RADIUS > Live logs**.
- Step 2** From the **Refresh** drop-down list, choose a time interval to change the data refresh rate.
- Step 3** Click the **Refresh** icon to manually update the data.
- Step 4** From the **Show** drop-down list, choose an option to change the number of records that appear.
- Step 5** From the **Within** drop-down list, choose an option to specify a time interval.
- Step 6** Click **Add or Remove Columns** and choose the options from the drop-down list to change the columns that are displayed.
- Step 7** Click **Save** at the bottom of the window to save your modifications.

**Step 8** Click **Show Live Sessions** to view the live RADIUS sessions.

You can use the dynamic Change of Authorization (CoA) feature for the live sessions that allows you to dynamically control active RADIUS sessions. You can send reauthenticate or disconnect requests to a Network Access Device (NAD).

---

## Filter Data in the Live Authentications Page

Using the filters in the **Live Authentications** window, you can filter the information that you need, and troubleshoot network authentication issues quickly. You can filter records in the Authentication **Live Logs** window and view only those records that you are interested in. The authentication logs contain many details, and filtering the authentications by a particular user or location helps you scan the data quickly. You can use several operators that are available in the **Live Authentications** window to filter out records based on your search criteria.:

- 'abc' : Contains 'abc'
- '!abc' : Does not contain 'abc'
- '{} ' : Is empty
- '!{} ' : Is not empty
- 'abc\*' : Starts with 'abc'
- '\*abc' : Ends with 'abc'
- '\!', '\\*', '\{', '\\' : Escape

The Escape option allows you to filter text with special characters (including the special characters used as filters). You must prefix the special character with a backward slash (\). For example, if you want to view the authentication records of users with identity "Employee!," enter "Employee\!" in the **Identity Filter** field. In this example, Cisco ISE considers the exclamation mark (!) as a literal character and not as a special character.

In addition, the **Status** field allows you to filter only passed authentication records, failed authentications, live sessions, and so on. The green check mark filters all the passed authentications that occurred in the past. The red cross mark filters all failed authentications. The blue i icon filters all the live sessions. You can also choose to view a combination of these options.

---

**Step 1** Choose **Operations > RADIUS > Live Logs**.

**Step 2** Filter data based on any of the fields in the **Show Live Authentications** window.

You can filter the results based on passed or failed authentications, or live sessions.

---

## Global Search for Endpoints

You can use the global search box available at the top of the Cisco ISE home page to search for endpoints. You can use any of the following criteria to search for an endpoint:

- User name

- MAC Address
- IP Address
- Authorization Profile
- Endpoint Profile
- Failure Reason
- Identity Group
- Identity Store
- Network Device name
- Network Device Type
- Operating System
- Posture Status
- Location
- Security Group
- User Type

You should enter at least three characters for any of the search criteria in the Search field to display data.



---

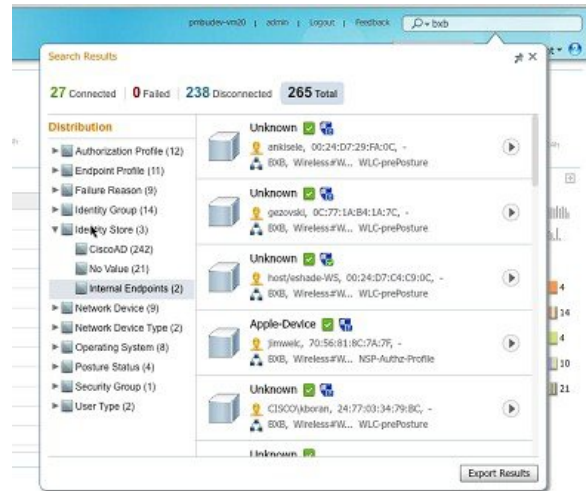
**Note** If an endpoint has been authenticated by Cisco ISE, or its accounting update has been received, it can be found through the global search. Endpoints that have been manually added and are not authenticated by or accounted for in Cisco ISE will not show up in the search results.

---

The search result provides a detailed and at-a-glance information about the current status of the endpoint, which you can use for troubleshooting. Search results display only the top 25 entries. You can use filters to narrow down the results.

The following figure shows an example of the search result.

Figure 69: Search Result For Endpoints



You can use any of the properties in the left panel to filter the results. You can also click on any endpoint to see more detailed information about the endpoint, such as:

- Session trace
- Authentication details
- Accounting details
- Posture details
- Profiler details
- Client Provisioning details
- Guest accounting and activity

### Related Topics

[Session Trace for an Endpoint](#), on page 875

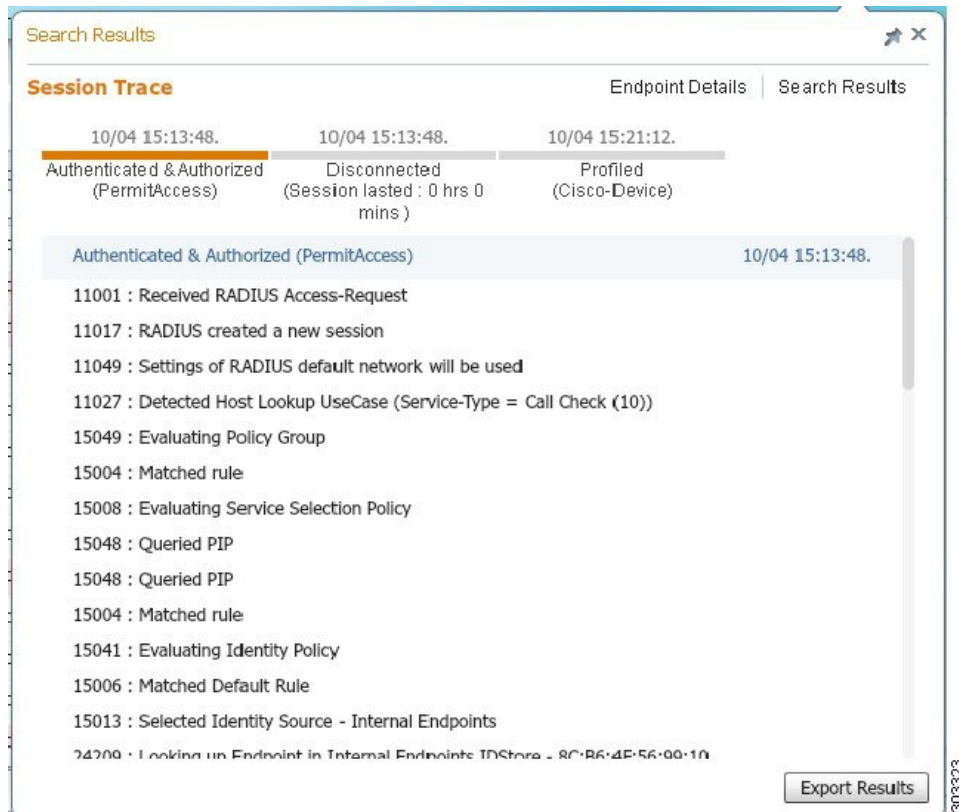
## Session Trace for an Endpoint

You can use the global search box available at the top of the Cisco ISE home page to get session information for a particular endpoint. When you search with a criteria, you get a list of endpoints. Click on any of these endpoints to see the session trace information for that endpoint. The following figure shows an example of the session trace information displayed for an endpoint.



**Note** The dataset used for search is based on Endpoint ID as indexes. Therefore, when authentication occurs, it is mandatory to have Endpoint IDs for the endpoints for those authentications to include them in the search result set.

Figure 70: Session Trace of an Endpoint



You can use the clickable timeline at the top to see major authorization transitions. You can also export the results in .csv format by using the **Export Results** option. The report gets downloaded to your browser.

You can click the **Endpoint Details** link to see more authentication, accounting, and profiler information for a particular endpoint. The following figure shows an example of endpoint details information displayed for an endpoint.



Figure 71: Endpoint Details

Search Results

Endpoint Details Session Trace Search Results

Authentication Accounting Profiler

Details

Name	Value
Source Timestamp	2012-11-07 10:54:40.688
Received Timestamp	2012-11-07 10:54:40.689
Policy Server	ise230
Event	80002 Profiler EndPoint profiling event occurred
Mac Address	00:0C:29:95:A5:C1
Endpoint Policy	WindowsXP-Workstation
Static Assignment	
Source	
Oui	VMware, Inc.
Hostname	
Property	port=9,StaticAssignment=false,VlanName=VLAN0030,ifOperStatus=1,cafSessionAuthorizedBy=Authentication Server,ifIndex=10109,ifDescr=GigabitEthernet1/0/9,cafSessionAuthUserName=00-0C-29-95-A5-C1,cafSessionDomain=2,BYODRegistration=Unknown,EndpointPolicyID=a5f92810-be86-11e1-ba69-0050568e002b,FirstCollection=1352205183395,TimeToProfile=70.1,astNmapScanTime=0,cafSessionStatus

Export Results

303319

## Session Removal from the Directory

Sessions are cleaned from the session directory on the Monitoring and Troubleshooting node as follows:

- Terminated sessions are cleaned 15 minutes after termination.
- If there is authentication but no accounting, then such sessions are cleared after one hour.
- All inactive sessions are cleared after five days.

### Related Topics

[Global Search for Endpoints](#), on page 873

## Authentication Summary Report

You can troubleshoot network access for a specific user, device, or search criteria based on the attributes that are related to the authentication requests. You can do this by running an Authentication Summary report.



**Note** You can generate the Authentication Summary report only for the last 30 days.

## Troubleshoot Network Access Issues

---

- Step 1** Choose **Operations** > **Reports** > **Authentication Summary Report**.
- Step 2** Filter the report for the **Failure Reasons**.
- Step 3** Review the data in the **Authentication by Failure Reasons** section of the report to troubleshoot your network access problem.
- Note** Because the Authentication Summary report collects and displays the latest data corresponding to failed or passed authentications, the contents of the report appear after a delay of a few minutes.

---

### Related Topics

[Troubleshoot Unexpected RADIUS Authentication Results](#), on page 878

## Diagnostic Troubleshooting Tools

Diagnostic tools help you diagnose and troubleshoot problems on a Cisco ISE network and provide detailed instructions on how to resolve problems. You can use these tools to troubleshoot authentications and evaluate the configuration of any network device on your network, including TrustSec devices.

### The RADIUS Authentication Troubleshooting Tool

This tool allows you to search for and select a RADIUS authentication or an Active Directory-related RADIUS authentication for troubleshooting when there is an unexpected authentication result. Use this tool if you expected an authentication to pass, but it failed, or if you expected a user or machine to have a certain level of privileges, and the user or machine did not have those privileges.

- Searching RADIUS authentications based on Username, Endpoint ID, Network Access Service (NAS) IP address, and reasons for authentication failure for troubleshooting, Cisco ISE displays authentications only for the system (current) date.
- Searching RADIUS authentications based on NAS port for troubleshooting, Cisco ISE displays all the NAS port values since the beginning of the previous month to the current date.




---

**Note** When searching for RADIUS authentications based on NAS IP Address and Endpoint ID Fields, a search is first performed in the operational database, and then in the configuration database.

---

## Troubleshoot Unexpected RADIUS Authentication Results

---

- Step 1** Choose **Operations** > **Troubleshoot** > **Diagnostic Tools** > > **General Tools** > **RADIUS Authentication Troubleshooting**.
- Step 2** Specify the search criteria in the fields, as needed.

- Step 3** Click **Search** to display the RADIUS authentications that match your search criteria.  
If you are searching for Active Directory-related authentication, and an Active Directory server is not configured in your deployment, a message stating *AD not configured* is displayed.
- Step 4** Select a RADIUS authentication record from the table, and click **Troubleshoot**.  
To troubleshoot Active Directory-related authentication, access the Diagnostics Tool under **Administration > Identity Management > External Identity Sources > Active Directory > AD node**.
- Step 5** Click **User Input Required**, modify the fields, as needed, and then click **Submit**.
- Step 6** Click **Done**.
- Step 7** Click **Show Results Summary** after the troubleshooting is complete.
- Step 8** (Optional) To view the diagnosis, the steps taken to resolve the problem, and the troubleshooting summary, click **Done**.
- 

## The Execute Network Device Command Diagnostic Tool

The Execute Network Device Command diagnostic tool allows you to run the **show** command on any network device.

The results that are displayed are the same as what you would see on a console. The tool enables you to identify problems, if any, in a device configuration.


Use this tool to validate the configuration of any network device, or if you are want to know how a network device is configured.

To access the Execute Network Device Command diagnostic tool, choose one of the following navigation paths:

1. Choose **Operations > Troubleshoot > Diagnostic Tools > Execute Network Device Command**. Choose **Work Centers > Profiler > Troubleshoot > Execute Network Device Command**.
2. In the **Execute Network Device Command** window that is displayed, enter the IP address of the network device and the **show** command that you want to run in the corresponding fields.
3. Click **Run**.

## Execute Cisco IOS show Commands to Check Configuration

---

- Step 1** Choose **Operations > Troubleshoot > Diagnostic Tools > General Tools > Execute Network Device Command**.
- Step 2** In the Cisco ISE GUI, click the **Menu** icon () and choose **Operations > Troubleshoot > Diagnostic Tools > General Tools > Execute Network Device Command**.
- Step 3** Enter the information in the appropriate fields.
- Step 4** Click **Run** to execute the command on the specified network device.
- Step 5** Click **User Input Required**, and modify the fields, as necessary.
- Step 6** Click **Submit** to run the command on the network device, and view the output.
-

## The Evaluate Configuration Validator Tool

You can use this diagnostic tool to evaluate the configuration of a network device and identify configuration problems, if any. The **Expert Troubleshooter** compares the configuration of the device with the standard configuration.

### Troubleshoot Network Device Configuration Issues

---

- Step 1** Choose **Operations > Troubleshoot > Diagnostic Tools > General Tools > Evaluate Configuration Validator**.
  - Step 2** Enter the IP address of the network device you want to evaluate in the **Network Device IP** field.
  - Step 3** Check the check boxes and click the radio buttons next to the configuration options you want to compare against the recommended template.
  - Step 4** Click **Run**.
  - Step 5** Click **User Input Required**, and modify the fields, as necessary.
  - Step 6** (Optional) Check the check boxes next to the interfaces that you want to analyze, and click **Submit**.
  - Step 7** (Optional) Click **Show Results Summary** for details of the configuration evaluation.
- 

### Posture Troubleshooting Tool

The Posture Troubleshooting tool helps you find the cause of a posture-check failure to identify the following:

- Which endpoints were successful in posture and which were not.
- If an endpoint failed in posture, what steps failed in the posture process.
- Which mandatory and optional checks passed and failed.

You determine this information by filtering requests based on parameters, such as username, MAC address, and posture status.

### Troubleshoot Endpoint Posture Failure

---

- Step 1** Choose **Operations > Troubleshoot > Diagnostic Tools > General Tools > Posture Troubleshooting**.
  - Step 2** Enter the information in the appropriate fields.
  - Step 3** Click **Search**.
  - Step 4** To find an explanation and determine a resolution for an event, select the event in the list and click **Troubleshoot**.
- 

### Session Trace Test Cases

This tool allows you to test policy flows in a predictable way to check and verify the way that the policy is configured, without needing to have real traffic originate from a real device.

You can configure the list of attributes and their values to be used in a test case. These details are used to perform interactions with the Policy system to simulate the run-time invocation of the policy.

The attributes can be configured by using dictionaries. All the dictionaries that are applicable to Simple RADIUS authentication are listed in the **Attributes** field.



---

**Note** You can configure test cases only for Simple RADIUS authentication.

---

## Configure a Session Trace Test Case

### Before you begin

To perform the following task, you must be a Super Admin or System Admin.

- 
- Step 1** Choose **Operations > Troubleshoot > Diagnostic Tools > General Tools > Session Trace Test Cases**.
- Step 2** Click **Add**.
- Step 3** In the **Test Details** tab, enter a name and description for the test case.
- Step 4** Select one of the predefined test cases or configure the required attributes and their values. The following predefined Test Cases are available:
- Basic Authenticated Access
  - Profiled Cisco Phones
  - Compliant Devices Access
  - Wi-Fi Guest (Redirect)
  - Wi-Fi Guest (Access)
- After you select a predefined test case, Cisco ISE automatically populates the relevant attributes for the test case. You can use the default values of these attributes or select a value from the displayed options. You can also add additional custom attributes to the test case.
- The attributes and the values that you add to the test case are listed in the **Text** field (below the **Custom Attributes** field). When you edit the content in the **Text** field, Cisco ISE checks the validity and syntax of the updated content.
- You can view the summary of all the attributes at the bottom of the **Test Details** window.
- Step 5** Click **Submit**.
- Cisco ISE validates the attributes and their values and indicates errors, if any, before saving the test details.
- Step 6** In the **Test Visualizer** tab, select the node on which you want to run this Test Case.
- Note** Only the nodes with Policy Service persona are displayed in the **ISE Node** drop-down list.
- Click **User Groups/Attributes** to retrieve the groups and attributes for a user from an external identity store.
- Step 7** Click **Execute**.

Cisco ISE executes the Test Case and displays the step-by-step results of the test case in a tabular format. It displays the policy stages, matching rules, and result objects. Click the green icon to view the details for each step.

- Step 8** (Optional) Click the **Previous Test Executions** tab to view the results of previous test executions. You can also select and compare any two test cases. Cisco ISE displays the comparative view of the attributes for each test case in a tabular format.
- Step 9** You can launch the Session Trace Test Case tool from the **RADIUS Live Logs** window. You can select an entry on the **Live Logs** window and click the **Actions** icon (in the **Details** column) to launch the **Session Trace Test Case** tool. Cisco ISE extracts the relevant attributes and their values from the corresponding log entry. You can modify these attributes and values, if required, and execute the test case.

---

## Technical Support Tunnel for Advanced Troubleshooting

Cisco ISE uses the Cisco IronPort Tunnel infrastructure to create a secure tunnel for Cisco technical support engineers to connect to an ISE server and troubleshoot issues with the system. Cisco ISE uses SSH to create the secure connection through the tunnel.

As an administrator, you can control the tunnel access—you can choose when and how long to grant access to a support engineer. Cisco Customer Support cannot establish the tunnel without your intervention. You will receive notifications about the service logins. You can disable the tunnel connection at any point of time. By default, the technical support tunnel remains open for 72 hours. However, we recommend that you or the support engineer close the tunnel after all the troubleshooting work is complete. Note that you can choose to extend the tunnel beyond 72 hours, if needed.

Use the **tech support-tunnel enable** command to initiate a tunnel connection.

The **tech support-tunnel status** command displays the status of the connection. This command provides information on whether the connection is established or not, if there is an authentication failure, or if the servers are unreachable. If the tunnel server is reachable, but ISE is unable to authenticate, ISE tries to authenticate again every five minutes for a period of 30 minutes, after which the tunnel is disabled.

You can disable the tunnel connection using the **tech support-tunnel disable** command. This command disconnects an existing tunnel even if a support engineer is currently logged in.

If you have already established a tunnel connection from an ISE server, the SSH keys that are generated are available on the ISE server. When you try to enable the support tunnel at a later point of time, the system prompts you about reusing the SSH keys generated earlier. You can choose to use the same keys or generate new keys. You can also manually reset the keys using the **tech support-tunnel resetkey** command. If you execute this command when a tunnel connection is enabled, the system prompts you to disable the connection first. If you choose to continue with the existing connection and not disable the connection the keys are reset after the existing connection is disabled. If you choose to disable the connection, the tunnel connection is dropped and the keys are reset immediately.

After you establish a tunnel connection, you can extend it using the **tech support-tunnel extend** command.

See the [Cisco Identity Services Engine CLI Reference Guide](#) for usage guidelines about the **tech support-tunnel** command.

## Establish a Technical Support Tunnel

You can establish a secure tunnel through the Cisco ISE CLI.

- 
- Step 1** Enter the following command from the Cisco ISE CLI:
- ```
tech support-tunnel enable
```
- The system prompts you for a password and a nickname for the tunnel.
- Step 2** Enter the password.
- Step 3** (Optional) Enter a nickname for the tunnel.
- The system generates an SSH key and displays the password, device serial number, and the SSH key.
- Step 4** Copy the password, device serial number, and SSH key and send it to Cisco Customer Support.
- The support engineer can now securely connect to your ISE server. You will receive periodic notifications about service logins.
-

TCP Dump Utility to Validate Incoming Traffic

The TCP Dump Utility sniffs packets that you can use to verify if the expected packet has reached a node. For example, when there is no incoming authentication or log indicated in the report, you may suspect that there is no incoming traffic, or that the incoming traffic cannot reach Cisco ISE. In such cases, you can run this tool to validate.

You can configure the TCP dump options and then collect data from the network traffic to help you troubleshoot a network issue.



Caution Starting a TCP Dump automatically deletes a previous dump file. To save a previous dump file, perform the task, as described in the Saving a TCP Dump File section before you begin a new TCP Dump session.


Related Topics

[Save a TCP Dump File](#), on page 884

Use TCP Dump to Monitor Network Traffic

Before you begin

The **Network Interface** drop-down list in the **TCP Dump** window displays only the network interface cards (NICs) that have an IPv4 or IPv6 address configured. By default in VMware, all the NICs are connected, which means that all the NICs have an IPv6 address and are displayed in the **Network Interface** drop-down list.

-
- Step 1** Choose **Operations > Troubleshoot > Diagnostic Tools > General Tools > TCP Dump**.
- Step 2** In the Cisco ISE GUI, click the **Menu** icon () and choose **Operations > Troubleshoot > Diagnostic Tools > General Tools > TCP Dump**.
- Step 3** From the **Host Name** drop-down list, choose the source for the TCP Dump utility.

- Step 4** From the **Network Interface** drop-down list, choose an interface to monitor.
- Step 5** Click the **Promiscuous Mode** toggle button to On or Off. The default is On.
Promiscuous mode is the default packet sniffing mode in which the network interface passes all the traffic to the system's CPU. We recommend that you leave it On.
- Step 6** In the **Filter** field, enter a boolean expression on which to filter.
The following are supported standard TCP dump filter expressions:
- ip host 10.77.122.123
 - ip host ISE123
 - ip host 10.77.122.123 and not 10.77.122.119
- Step 7** Click **Start** to begin monitoring the network.
- Step 8** Click **Stop** after you have collected a sufficient amount of data, or wait for the process to conclude automatically after accumulating the maximum number of packets which is 500,000.



Note Cisco ISE does not support frames greater than 1500 MTU (jumbo frames).

Related Topics

[Save a TCP Dump File](#), on page 884

Save a TCP Dump File

Before you begin


You should have successfully completed the task, as described in [Using TCP Dump to Monitor network Traffic](#) section.



Note You can also access TCP Dump through the Cisco ISE CLI. For more information, see the *Cisco Identity Services Engine CLI Reference Guide*.

- Step 1** Choose **Operations > Troubleshoot > Diagnostic Tools > General Tools > TCP Dump**.
- Step 2** From the **Format** drop-down list, choose an option. **Human Readable** is the default.
- Step 3** Click **Download**, corresponding to the desired location, and then click **Save**.
- Step 4** (Optional) To get rid of the previous dump file without saving it, click **Delete**.

Compare Unexpected SGACL for an Endpoint or User

-
- Step 1** Choose **Operations > Troubleshoot > Diagnostic Tools > TrustSec Tools > Egress (SGACL) Policy**.
- Step 2** In the Cisco ISE GUI, click the **Menu** icon () and choose **Operations > Troubleshoot > Diagnostic Tools > TrustSec Tools > Egress (SGACL) Policy**.
- Step 3** Enter the network device IP address of the TrustSec device whose SGACL policy you want to compare.
- Step 4** Click **Run**.
- Step 5** Click **User Input Required** and modify the fields, as necessary.
- Step 6** Click **Submit**.
- Step 7** Click **Show Results Summary** to view the diagnosis and suggested resolution steps.
-

Egress Policy Diagnostic Flow

The Egress Policy diagnostic tool uses the process described in the following table:

| Process Stage | Description |
|---------------|--|
| 1 | Connects a the device with the IP address that you provided, and obtains the access control lists (ACLs) for each source and destination SGT pair. |
| 2 | Checks the egress policy that is configured in Cisco ISE and obtains the ACLs for each source and destination SGT pair. |
| 3 | Compares the SGACL policy that is obtained from the network device with the SGACL policy that is obtained from Cisco ISE. |
| 4 | Displays the source and destination SGT pair if there is a mismatch. Also, displays the matching entries as additional information. |

Troubleshoot Connectivity Issues in a Trustsec-Enabled Network with SXP-IP Mappings

-
- Step 1** Choose **Operations > Troubleshoot > Diagnostic Tools > Trustsec Tools > SXP-IP Mappings** .
- Step 2** Enter the IP address of the network device.
- Step 3** Click **Select**.
- Step 4** Click **Run**.

The Expert Troubleshooter retrieves TrustSec SXP connections from the network device and again prompts you to select the peer SXP devices.

- Step 5** Click **User Input Required**, and enter the necessary information, in that field.
 - Step 6** Check the check box of the peer SXP devices for which you want to compare SXP mappings, and enter the common connection parameters.
 - Step 7** Click **Submit**.
 - Step 8** Click **Show Results Summary** to view the diagnosis and resolution steps.
-

Troubleshoot Connectivity Issues in a TrustSec-Enabled Network with IP-SGT Mappings

- Step 1** Choose **Operations > Troubleshoot > Diagnostic Tools > TrustSec Tools > IP User SGT**.
 - Step 2** Enter the information in the fields, as needed.
 - Step 3** Click **Run**.
You are prompted for additional input.
 - Step 4** Click **User Input Required** and modify the fields, as necessary.
 - Step 5** Click **Submit**.
 - Step 6** Click **Show Results Summary** to view the diagnosis and resolution steps.
-

Device SGT Tool

For devices that are enabled with the TrustSec solution, each network device is assigned an SGT value through RADIUS authentication. The Device SGT diagnostic tool connects to the network device (with the IP address that you provide) and obtains the network device SGT value. It then checks the RADIUS authentication records to determine the SGT value assigned most recently. Finally, it displays the Device-SGT pairs in a tabular format, and identifies whether the SGT values are the same or different.

Troubleshoot Connectivity Issues in a TrustSec-Enabled Network by Comparing Device SGT Mappings

- Step 1** Choose **Operations > Troubleshoot > Diagnostic Tools > Trustsec Tools > Device SGT**.
 - Step 2** Enter the information in the fields, as needed.
The default port number for Telnet is 23 and SSH is 22.
 - Step 3** Click **Run**.
 - Step 4** Click **Show Results Summary** to view the results of the device SGT comparison.
-

Download Endpoint Statistical Data from MnT Nodes

You can download statistical data about endpoints that connect to your network from the MnT nodes. Key Performance Metrics (KPM), which include the load, CPU usage, authentication traffic data are available. You can use to monitor and troubleshoot issues in your network. From the Cisco ISE CLI, use the **application configure ise** command and choose options 12 or 13 to download the daily KPM statistics or KPM statistics for the last eight weeks.

The output of this command provides the following data about endpoints:

- Total endpoints on your network
- Number of endpoints that established a successful connection
- Number of endpoints that failed authentication
- Total number of new endpoints that have connected each day
- Total number of endpoints onboarded each day

The output also includes time stamp details, the total number of endpoints that connected through each of the Policy Service nodes (PSNs) in the deployment, total number of endpoints, active endpoints, load, and authentication traffic details.

See the *Cisco Identity Services Engine CLI Reference Guide* for more information on this command.

Obtaining Additional Troubleshooting Information

Cisco ISE allows you to download support and troubleshooting information from the Admin portal. You can use the support bundles to prepare diagnostic information for the Cisco Technical Assistance Center (TAC) to troubleshoot problems with Cisco ISE.



Note The support bundles and debug logs provide advanced troubleshooting information for TAC and are difficult to interpret. You can use the various reports and troubleshooting tools that Cisco ISE provides to diagnose and troubleshoot issues that you are facing in your network.

Related Topics

[Troubleshoot Network Access Issues](#), on page 878

Cisco ISE Support Bundle

You can configure the logs that you want to be a part of your support bundle. For example, you can configure logs from a particular service to be a part of your debug logs. You can also filter the logs based on dates.

The logs that you can download are categorized as follows:

- Full configuration database: Contains the Cisco ISE configuration database in a human-readable XML format. When you troubleshoot issues, you can import this database configuration into another Cisco ISE node to re-create the scenario.

- Debug logs: Captures bootstrap, application configuration, run-time, deployment, public key infrastructure (PKI) information, and monitoring and reporting.

Debug logs provide troubleshooting information for specific Cisco ISE components. To enable debug logs, see chapter 11 on *Logging*. If you do not enable the debug logs, all the informational messages (INFO) will be included in the support bundle. For more information, see [Cisco ISE Debug Logs, on page 889](#).

- Local logs: Contains syslog messages from the various processes that run on Cisco ISE.
- Core files: Contains critical information that helps identify the cause of a crash. These logs are created when the application crashes, and includes heap dumps.
- Monitoring and reporting logs: Contains information about alerts and reports.
- System logs: Contains Cisco Application Deployment Engine-related (ADE-related) information.
- Policy configuration: Contains policies configured in Cisco ISE in human-readable format.

You can download these logs from the Cisco ISE CLI by using the **backup-logs** command. For more information, see the *Cisco Identity Services Engine CLI Reference Guide*.



Note For Inline Posture node, you cannot download the support bundle from the Admin portal. You must use the **backup-logs** command from the Cisco ISE CLI.

If you choose to download these logs from the Admin portal, you can do the following:

- Download only a subset of logs based on the log type, such as debug logs or system logs.
- Download only the latest *n* number of files for the selected log type. This option allows you to control the size of the support bundle and the time taken for download.

Monitoring logs provide information about the monitoring, reporting, and troubleshooting features. For more information about downloading logs, see [Download Cisco ISE Log Files, on page 888](#).

Support Bundle

You can download the support bundle to your local computer as a simple tar.gpg file. The support bundle will be named with the date and time stamps in the format `ise-support-bundle_ise-support-bundle-mm-dd-yyyy--hh-mm.tar.gpg`. The browser prompts you to save the support bundle to an appropriate location. You can extract the content of the support bundle and view the README.TXT file, which describes the contents of the support bundle, as well as how to import the contents of the ISE database if it is included in the support bundle.

Download Cisco ISE Log Files

You can download the Cisco ISE log files to look for more information while troubleshooting issues in your network.

You can also download system logs that include ADE-OS and other log files to troubleshoot installation and upgrade issues.

While downloading a support bundle, instead of entering an encryption key manually, you can choose to use a public key for encryption. If you choose this option, Cisco PKI will be used for encryption and decryption of the support bundle. Cisco TAC maintains the public and private keys. Cisco ISE uses the public keys to encrypt the support bundle. Cisco TAC can decrypt the support bundle using the private keys. Use this option if you want to provide the support bundle to Cisco TAC for troubleshooting. Use the shared key encryption if you are going to troubleshoot the issues on premise.

Before you begin

- You must have Super Admin or System Admin privileges to perform the following task.
- You should have configured the debug logs and debug log levels.

Step 1 Choose **Operations** > **Troubleshoot** > **Download Logs** > **Appliance Node List**.

Step 2 Click the node from which you want to download the support bundles.

Step 3 In the **Support Bundle** tab, choose the parameters that you want to be populated in your support bundle.

If you include all the logs, your support bundle will be excessively large and the download will take a long time. To optimize the download process, choose to download only the most recent *n* number of files.

Step 4 Enter the **From** and **To** dates for which you want to generate the support bundle.

Step 5 Choose one of the following:

- **Public Key Encryption:** Choose this option if you want to provide the support bundle to Cisco TAC for troubleshooting purposes.
- **Shared Key Encryption:** Choose this option if you want to troubleshoot the issues locally on premise. If you choose this option, you must enter the encryption key for the support bundle.

Step 6 Enter and re-enter the encryption key for the support bundle.

Step 7 Click **Create Support Bundle**.

Step 8 Click **Download** to download the newly-created support bundle.

The support bundle is a tar.gpg file that is downloaded to the client system that is running your application browser.

What to do next

Download debug logs for specific components.

Related Topics

[Download Debug Logs](#), on page 892

Cisco ISE Debug Logs

Debug logs provide troubleshooting information for various Cisco ISE components. Debug logs contain critical and warning alarms generated over the last 30 days, and information alarms generated over the last seven days. While reporting problems, you might be asked to enable these debug logs and send them for diagnosis and resolution of your problems.



Note Enabling debug logs with heavy load (such as monitoring debug logs) will generate alarms about high load.

Obtain Debug Logs

Step 1 Configure the components for which you want to obtain debug logs.

Step 2 Download the debug logs.

Related Topics

[Download Debug Logs](#), on page 892

Cisco ISE Components and Corresponding Debug Logs

Table 71: Components and Corresponding Debug Logs

| Component | Debug Log |
|-----------------------------------|-----------------|
| Active Directory | ad_agent.log |
| Cache Tracker | tracking.log |
| Entity Definition Framework (EDF) | edf.log |
| JMS | ise-psc.log |
| License | ise-psc.log |
| Notification Tracker | tracking.log |
| Replication-Deployment | replication.log |
| Replication-JGroup | replication.log |
| Replication Tracker | tracking.log |
| RuleEngine-Attributes | ise-psc.log |
| RuleEngine-Policy-IDGroups | ise-psc.log |
| accessfilter | ise-psc.log |
| admin-infra | ise-psc.log |
| boot-strap wizard | ise-psc.log |
| cisco-mnt | ise-psc.log |
| client | ise-psc.log |
| cpm-clustering | ise-psc.log |
| cpm-mnt | ise-psc.log |
| epm-pdp | ise-psc.log |
| epm-pip | ise-psc.log |

| Component | Debug Log |
|------------------------|---------------------|
| anc | ise-psc.log |
| anc | ise-psc.log |
| ers | ise-psc.log |
| guest | ise-psc.log |
| Guest Access Admin | guest.log |
| Guest Access | guest.log |
| MyDevices | guest.log |
| Portal | guest.log |
| Portal-Session-Manager | guest.log |
| Portal-web-action | guest.log |
| guestauth | ise-psc.log |
| guestportal | ise-psc.log |
| identitystore-AD | ise-psc.log |
| infrastructure | ise-psc.log |
| mdm | ise-psc.log |
| mdm-pip | ise-psc.log |
| mnt-report | reports.log |
| mydevices | ise-psc.log |
| nsf | ise-psc.log |
| nsf-session | ise-psc.log |
| org-apache | ise-psc.log |
| org-apache-cxf | ise-psc.log |
| org-apache-digester | ise-psc.log |
| posture | ise-psc.log |
| profiler | profiler.log |
| provisioning | ise-psc.log |
| prtt-JNI | prtt-management.log |
| runtime-AAA | prtt-management.log |
| runtime-config | prtt-management.log |
| runtime-logging | prtt-management.log |
| sponsorportal | ise-psc.log |

| Component | Debug Log |
|-----------|-------------|
| swiss | ise-psc.log |

Download Debug Logs

Before you begin

To perform the following task, you must be a Super Admin or System Admin.

Step 1 Choose **Operations** > **Troubleshoot** > **Download Logs** > **Appliance Node List**.

Step 2 From the Appliance node list, click the node for which you want to download the debug logs.

Step 3 Click the **Debug Logs** tab.

A list of debug log types and debug logs is displayed. This list is based on your debug log configuration.

Step 4 Click the log file that you want to download and save it to the system that is running your client browser.

You can repeat this process to download other log files as needed. The following are the additional debug logs that you can download from the **Debug Logs** window:

- isebootstrap.log: Provides bootstrapping log messages
- monit.log: Provides watchdog messages
- pki.log: Provides third-party crypto library logs
- iseLocalStore.log: Provides logs about the local store files
- ad_agent.log: Provides Microsoft Active Directory third-party library logs
- catalina.log: Provides third-party logs

Monitoring Database

The rate and amount of data that is utilized by the monitoring functions requires a separate database on a dedicated node that is used for these purposes.

Like PSN, the MnT node has a dedicated database that requires you to perform maintenance tasks, as described in the topics covered in this section.

Related Topics

[Log Collection](#), on page 871

[Back Up and Restore the Monitoring Database](#), on page 893

[Monitoring Database Purge](#), on page 893

Back Up and Restore the Monitoring Database

The Monitoring database handles large volumes of data. Over time, the performance and efficiency of the MnT node depends on how well you manage that data. To increase efficiency, we recommend that you back up the data and transfer it to a remote repository on a regular basis. You can automate this task by scheduling automatic backups.



Note You should not perform a backup when a purge operation is in progress. If you start a backup during a purge operation, the purge operation stops or fails.

If you register a secondary MnT node, we recommend that you first back up the primary MnT node and then restore the data to the new secondary MnT node. This ensures that the history of the primary MnT node is in sync with the new secondary node when the new changes are replicated.

Monitoring Database Purge

The purging process allows you to manage the size of the Monitoring database by specifying the number of months to retain the data during a purge. The default is three months. This value is utilized when the disk space usage threshold for purging (80 percentage of the total disk space) is met. For this option, each month consists of 30 days. A default of three months equals 90 days.

Related Topics

[Guidelines for Purging the Monitoring Database](#), on page 893

Guidelines for Purging the Monitoring Database

Follow these guidelines for optimal relating to Monitoring database disk usage:

- If the Monitoring database disk usage is greater than 80 percentage of the threshold setting, that is 60% of total disk space, a critical alarm is generated, indicating that the database size is about to exceed the maximum amount of allocated disk size. If the disk usage is greater than 90 percentage of the threshold setting, that is 70% of total disk space, another alarm is generated, indicating that the database size has exceeded the maximum amount of allocated disk size.

A purge process runs, creating a status history report that you can view in the **Data Purging Audit** window. The navigation path to this window is **Operations > Reports > Reports > Audit > Data Purging Audit**. An information (INFO) alarm is generated after the purge is completed.

- Purging is also based on the percentage of consumed disk space for the database. When the consumed disk space for the Monitoring database is equal to or exceeds the threshold (the default is 80 percentage of the total disk space), the purge process starts. This process deletes only the oldest seven days' monitoring data, irrespective of what is configured in the Admin portal. It will continue this process in a loop until the disk space is below 80 percent. Purging always checks the Monitoring database disk space limit before proceeding.

Operational Data Purging

Cisco ISE Monitoring Operational database contains information that is generated as Cisco ISE reports. Recent Cisco ISE releases have options to purge the monitoring operational data and reset the monitoring database after running the Cisco ISE admin **application configure ise**. CLI command.

The purge option is used to clean up the data and prompts you to enter the number of days for which to retain the data. The reset option is used to reset the database to the factory default, so that all the data that is backed up will be permanently deleted. Specify the database if the files are consuming too much file system space.



Note The reset option will cause Cisco ISE services to be temporarily unavailable until it restarts.

The **Operational Data Purging** window contains the **Database Utilization** and **Purge Data Now** areas. The navigation path for this window is **Administration > System > Maintenance > Operational Data Purging**. You can view the total available database space and the RADIUS and TACACS data stored in the **Database Utilization** area. Hover the mouse over the status bar to display the available disk space and the number of days the existing data is stored in the database. Specify the period for which the RADIUS and TACACS data is supposed to be retained in the **Data Retention Period** area. Data is purged at 4 a.m. every day, and you can configure to export data to a repository before it is purged, by specifying the number of retention days. Check the **Enable Export Repository** check box to select and create a repository, and specify an **Encryption Key**.

In the **Purge Data Now** area, you can purge all the RADIUS and TACACS data or specify the number of days beyond which data is supposed to be purged.



Note You must export RADIUS authentication and accounting, TACACS authorization and accounting, RADIUS errors, and misconfigured supplicants tables to a repository before purging.

Related Topics

[Purge Older Operational Data](#), on page 894

Purge Older Operational Data

The operational data is collected in the server over a period of time. It can be purged either instantly or periodically. You can verify the success of the data purge by viewing the **Data Purging Audit** report.

Before you begin

To perform the following task, you must be a Super Admin or System Admin.

Step 1 Choose **Administration > System > Maintenance > Operational Data Purging**.

Step 2 Do one of the following:

- In the **Data Retention Period** area:
 - a. Specify the time period, in days, for which RADIUS and TACACS data should be retained. All the data prior to the specified time period is exported to a repository.
 - b. In the **Repository** area, check the **Enable Export Repository** check box to choose the repository to save data.

- c. In the **Encryption Key** field, enter the required password.
- d. Click **Save**.

Note If the configured retention period is less than the existing retention thresholds corresponding to the diagnostics data, then the configured value overrides the existing threshold values. For example, if you configure the retention period as three days and this value is less than the existing thresholds in the diagnostics tables (for example, a default of five days), then the data is purged according to the value that you configure (three days) in this window.

- In the **Purge Data Now** area:
 - a. Choose to purge all the data or to purge the data that is older than the specified number of days. Data is not saved in any repository.
 - b. Click **Purge**.

Database Crash or File Corruption Issues

Cisco ISE may crash if the oracle database files are corrupted due to power outage or other reasons resulting in data loss. Based on the incident, follow the instructions below to recover from data loss.

- In case of PAN corruption in deployment, you should [promote the Secondary PAN to Primary PAN](#).
- If the secondary PAN's promotion is not possible due to a small deployment or any other reason, [restore the most recent available backup as described in Cisco Identity Services Engine CLI Reference Guide](#).
- In case of PSN corruption, follow the steps to de-register, reset config, and register as described in the [Cisco Identity Services Engine CLI Reference Guide](#).
- In case of a standalone device, restore the most recent available backup as described in [Cisco Identity Services Engine CLI Reference Guide](#).



Note Obtain the backup from the standalone device regularly to avoid loss in the latest configuration changes.



CHAPTER 29

Reports

- [Cisco ISE Reports](#), on page 897
- [Report Filters](#), on page 897
- [Create the Quick Filter Criteria](#), on page 898
- [Create the Advanced Filter Criteria](#), on page 898
- [Run and View Reports](#), on page 899
- [Reports Navigation](#), on page 899
- [Export Reports](#), on page 900
- [Schedule and Save Cisco ISE Reports](#), on page 901
- [Cisco ISE Active RADIUS Sessions](#), on page 902
- [Available Reports](#), on page 903

Cisco ISE Reports

Cisco Identity Services Engine (ISE) reports are used with monitoring and troubleshooting features to analyze trends, and, monitor system performance and network activities from a central location.

Cisco ISE collects logs and configuration data from your network. It then aggregates the data into reports for you to view and analyze. Cisco ISE provides a standard set of predefined reports that you can use and customize to fit your needs.

Cisco ISE reports are pre-configured and grouped into categories with information related to authentication, session traffic, device administration, configuration, administration, and troubleshooting.

Related Topics

- [Run and View Reports](#), on page 899
- [Export Reports](#), on page 900
- [Available Reports](#), on page 903

Report Filters

There are two types of reports, single-section and multi-section. Single-section reports contain a single grid (Radius Authentications report) and multi-section reports contain many grids (Authentications Summary report) and represent data in the form of charts and tables. The Filter drop-down menu in the single-section reports contains the **Quick Filter** and **Advanced Filter**. In the multi-section reports, you can specify only advanced filters.

Multi-section reports may contain one or more mandatory advanced filters that require your input. For example, when you click the Health Summary report (**Operations > Reports > Diagnostics** page), it displays two mandatory advanced filters—Server and Time Range. You must specify the operator command, server name, required values for both these filters, and click **Go** to generate the report. You can add new advanced filters by clicking the Plus (+) symbol. You can export multi-section reports only in the PDF format. You cannot schedule Cisco ISE multi-section reports to run and re-run at specific time or time intervals.



Note When you click a report, data for the last seven days is generated by default. However, some multi-section reports require mandatory input from the user apart from the time range.

By default, the Quick Filter is displayed as the first row in single-section reports. The fields may contain a drop-down list from which you can select the search criteria or may be a text box.

An Advanced Filter contains an outer criteria that contains one or more inner criteria. The outer criteria is used to specify if the search should meet All or Any specified inner criteria. The inner criteria contains one or more conditions that is used to specify the Category (Endpoint ID, Identity Group) Method (operator commands, such as Contains, Does Not Contain), and Time Range for the condition.

When using the **Quick Filter**, you can choose a date or time from the **Logged At** drop-down list to generate reports for a data set logged in the last 30 days or less. If you want to generate a report for a date or time prior to 30 days, use the **Advanced Filter** to set the required time frame in the **From** and **To** fields of the **Custom** option from the drop-down list.

Create the Quick Filter Criteria

The section describes how to create a quick filter criteria. You can create quick filter criteria for only single-section reports.

-
- Step 1** Choose **Operations > Reports** and click the required report.
 - Step 2** From the **Settings** drop-down list, choose the required fields.
 - Step 3** In the required field, you can choose from the drop-down list or type the specific characters to filter data. The search uses the Contains operator command. For example, to filter by text that begins with “K”, enter K or to filter text that has “geo” anywhere in the text, enter geo. You can also use asterisks (*), for example, the regex starting with *abc and ending with *def.

The quick filter uses the following conditions: contains, starts with, ends with, starts with or ends with, and multiple values with OR operator.
 - Step 4** Press **Enter**.
-

Create the Advanced Filter Criteria

The section describes how to create an advanced filter criteria. You can create advanced filters for single- and multi-section reports. The Filter drop-down menu in the single-section reports contains the **Quick Filter** and **Advanced Filter**. In the multi-section reports, you can specify only advanced filters.

-
- Step 1** Choose **Operations > Reports** and click the required report.
- Step 2** In the **Filters** section, from the **Match** drop-down list, choose one of the options.
- Choose **All** to match all specified conditions.
 - Choose **Any** to match any one specified condition.
- Step 3** From the **Time Range** drop-down list, choose the required category.
- Step 4** From the **Operator Commands** drop-down list, choose the required command. For example, you can filter text that begins with a specific character (use **Begin With**), or specific characters anywhere in the text (use **Contains**). Or, you can choose the **Logged Time** and corresponding **Custom** option and specify the **From** and **To** date and time from the calendar to filter data.
- Step 5** From the **Time Range** drop-down list, choose the required option.
- Step 6** Click **Go**.
-

You can save a filtered report and retrieve it from the **Filter** drop-down list for future reference.

Run and View Reports

This section describes how to run, view, and navigate reports using Reports View. When you click a report, by default, data for the last seven days is generated. Each report displays 1000 rows of data per page. You can specify time increments over which to display data in a report.

-
- Step 1** Choose **Operations > Reports > ISE Reports**.
- You can also navigate to the **Reports** link under each work center to view the set of reports specific to that work center.
- Step 2** Click a report from the **report** categories available.
- Step 3** Select one or more filters to run a report. Each report has different filters available, of which some are mandatory and some are optional.
- Step 4** Enter an appropriate value for the filters.
- Step 5** Click **Go**.
-

Related Topics

[Export Reports](#), on page 900

[Available Reports](#), on page 903

Reports Navigation

You can get detailed information from the reports output. For example, if you have generated a report for a period of five months, the graph and table will list the aggregate data for the report in a scale of months.

You can click a particular value from the table to see another report related to this particular field. For example, an authentication summary report will display the failed count for the user or user group. When you click the failed count, an authentication summary report is opened for that particular failed count.

Export Reports

You can export report data in the following file formats:

- Excel spreadsheet as a Comma Separated Values (.csv) file. After you export the data, you will receive an email detailing the location of the report.
- Microsoft Excel Comma Separated Values (CSV) file that can be saved to a local disk.
- Adobe Acrobat Document (.pdf) file that can be saved to a local disk.

You can only export the PDF file format of the following reports:

- Authentication Summary
- Health Summary
- RBACL Drop Summary



Note Flows for RBACL dropped packets are available only with the Cisco Catalyst 6500 series switches.

- Guest Sponsor summary
- End point Profile Changes
- Network Device Session Status



Note To view the non-English characters correctly after exporting a report, you must import the file into Microsoft Excel by enabling UTF-8 character encoding. If you choose to open the exported .csv file directly in Microsoft Excel without enabling UTF-8 character encoding, the non-English characters in the report might appear in some garbage form.



Note You can export report data to a .csv format only from the Primary PAN.

-
- Step 1** Run a report, as described in the Running and Viewing Reports section.
- Step 2** Click **Export To** in the top-right corner of the report summary page.
- Step 3** Specify the data columns that you want to export.
- Step 4** Choose a repository from the drop-down list.
- Step 5** Click **Export** .
- Step 6** Choose one of the following options:
- Repository (CSV): To export the report in CSV file format to a repository

- Local (CSV): To export the report in CSV file format to a local disk
- Local (PDF): To export the report in pdf file format to a local disk

- Note**
- When you select the local CSV or pdf option, only the first 500 records are exported. You can use the Repository CSV option to export all the records.
 - When you export the multi-section reports using the local pdf option, only the first 100 rows are exported for each section.

Schedule and Save Cisco ISE Reports

You can customize a report and save the changes as a new report, or restore the default report settings in **My Reports** at the top right corner of the report summary page.

You can also customize and schedule Cisco ISE reports to run and re-run at specific time or time intervals. You can also send and receive email notifications for the reports generated.

When scheduling reports with **Hourly** frequency, you can have the report run over multiple days, but the timeframe cannot spread across two days.

For example, when scheduling an hourly report from May 4, 2019, to May 8, 2019, you can set the time interval as between 6:00 a.m. and 11:00 p.m. each day, but not between 6:00 p.m. of one day and 11:00 a.m. of the next. Cisco ISE displays an error message that the time range is invalid in the latter case.



-
- Note** If an external administrator (for example: Active Directory Administrator) creates a scheduled report without filling the email-id field, no email notifications will be sent.
-

You cannot schedule the following reports:

- Authentication Summary
- Health Summary
- RBACL Drop Summary
- Guest Sponsor summary
- Endpoint Profile Changes
- Network Device Session Status



-
- Note** You can save or schedule (customize) Cisco ISE reports only from the PAN.
-

Step 1 Run a report as described in the Running and Viewing Reports section.

- Step 2** Click **My Reports** in the top right-hand corner of the report summary page.
- Step 3** Enter the required details in the dialog box.
- Step 4** Click **Save as New**.

When you go back to a saved report, all the filter options are checked by default. Uncheck the filters that you do not wish to use.

You can also remove a saved report from **My Reports** category.

Cisco ISE Active RADIUS Sessions

Cisco ISE provides a dynamic Change of Authorization (CoA) feature for the Live Sessions that allows you to dynamically control active RADIUS sessions. You can send reauthenticate or disconnect requests to a Network Access Device (NAD) to perform the following tasks:

- Troubleshoot issues related to authentication—You can use the Session reauthentication option to follow up with an attempt to reauthenticate again. However, you must not use this option to restrict access. To restrict access, use the shutdown option.
- Block a problematic host—You can use the Session termination with port shutdown option to block an infected host that sends a lot of traffic over the network. However, the RADIUS protocol does not currently support a method for re-enabling a port that has been shut down.
- Force endpoints to reacquire IP addresses—You can use the Session termination with port bounce option for endpoints that do not have a supplicant or client to generate a DHCP request after a VLAN change.
- Push an updated authorization policy to an endpoint—You can use the Session reauthentication option to enforce an updated policy configuration, such as a change in the authorization policy on existing sessions based on the discretion of the administrator. For example, if posture validation is enabled, when an endpoint gains access initially, it is usually quarantined. After the identity and posture of the endpoint are known, it is possible to send the Session reauthentication command to the endpoint for the endpoint to acquire the actual authorization policy based on its posture.

For CoA commands to be understood by the device, it is important that you configure the options appropriately.

For CoA to work properly, you must configure the shared secret of each device that requires a dynamic change of authorization. Cisco ISE uses the shared secret configuration to request access from the device and issue CoA commands to it.



Note In this release of Cisco ISE, the maximum number of active authenticated endpoint sessions that can be displayed is limited to 100,000.

Related Topics

[Change Authorization for RADIUS Sessions](#), on page 903

Change Authorization for RADIUS Sessions

Some Network Access Devices on your network may not send an Accounting Stop or Accounting Off packet after a reload. As a result, you might find two sessions in the Session Directory reports, one which has expired.

To dynamically change the authorization of an active RADIUS session or disconnect an active RADIUS session, be sure to choose the most recent session.

Step 1 Choose **Operations > RADIUS Livelog**.

Step 2 Switch the view to **Show Live Session**.

Step 3 Click the CoA link for the RADIUS session that you want to issue CoA and choose one of the following options:

- **SAnet Session Query**—Use this to query information about sessions from SAnet supported devices.
- **Session reauthentication**—Reauthenticate session. If you select this option for a session established on an ASA device supporting COA, this will invoke a Session Policy Push CoA.
- **Session reauthentication with last**—Use the last successful authentication method for this session.
- **Session reauthentication with rerun**—Run through the configured authentication method from the beginning.

Note **Session reauthentication with last** and **Session reauthentication with rerun** options are not currently supported in Cisco IOS software.

- **Session termination**—Just end the session. The switch reauthenticates the client in a different session.
- **Session termination with port bounce**—Terminate the session and restart the port.
- **Session termination with port shutdown**—Terminate the session and shutdown the port.

Step 4 Click **Run** to issue CoA with the selected reauthenticate or terminate option.

If your CoA fails, it could be one of the following reasons:

- Device does not support CoA.
- Changes have occurred to the identity or authorization policy.
- There is a shared secret mismatch.

Available Reports

The following table lists the preconfigured reports, grouped according to their category. Descriptions of the report functionality and logging category are also provided.

To generate syslogs for a logging category, set its **Log Severity Level** to **Info**:

- Choose **Administration > System > Logging > Logging Categories**.
- Click the logging category for which syslogs must be generated.
- From the **Log Severity Level** drop-down list, choose **Info**.

- Click **Save**.

| Report Name | Description | Logging Category |
|--------------------------------|---|---|
| Audit | | |
| Adaptive Network Control Audit | The Adaptive Network Control Audit report is based on RADIUS accounting. It displays historical reporting of all the network sessions for each endpoint. | Choose Administration > System > Logging > Logging Categories and select Passed Authentications and RADIUS Accounting. |
| Administrator Logins | The Administrator Logins report provides information about all the GUI-based administrator login events as well as successful CLI login events. | Choose Administration > System > Logging > Logging Categories , and click Administrative and Operational Audit . |
| Change Configuration Audit | The Change Configuration Audit report provides details about configuration changes within a specified time period. If you need to troubleshoot a feature, this report can help you determine if a recent configuration change contributed to the problem. | Choose Administration > System > Logging > Logging Categories , and click Administrative and Operational Audit . |

| Report Name | Description | Logging Category |
|----------------------------|---|---|
| Data Purging Audit | <p>The Data Purging Audit report records when the logging data is purged.</p> <p>This report reflects two sources of data purging.</p> <p>At 4 a.m. daily, Cisco ISE checks whether there are any logging files that meet the criteria you have set on the Administration > Maintenance > Data Purging window. If yes, the files are deleted and recorded in this report.</p> <p>Additionally, Cisco ISE continually maintains a maximum of 80 percent used storage space (threshold) for the log files. Every hour, Cisco ISE verifies this percentage and deletes the oldest data until this threshold is reached again. This information is also recorded in this report.</p> <p>If there is high disk space utilization, an alert message stating ISE Monitor node(s) is about to exceed the maximum amount allocated is displayed at 80 percent of the threshold, that is 60 percent of total disk space. Subsequently, an alert message stating ISE Monitor node(s) has exceeded the maximum amount allocated is displayed at 90 percent of the threshold, that is 70 percent of the total disk space.</p> | — |
| Endpoints Purge Activities | <p>The Endpoints Purge Activities report enables a user to review the history of endpoints purge activities. This report requires that the Profiler logging category is enabled. (Note that this category is enabled by default.)</p> | <p>Choose Administration > System > Logging > Logging Categories and select Profiler.</p> |

| Report Name | Description | Logging Category |
|--------------------------------|---|--|
| Internal Administrator Summary | The Internal Administrator Summary report enables you to verify the entitlement of administrator users. From this report, you can also access the Administrator Logins and Change Configuration Audit reports, which enables you to view these details for each administrator. | — |
| Operations Audit | The Operations Audit report provides details about any operational changes, such as, running backups, registering a Cisco ISE node, or restarting an application. | Choose Administration > System > Logging > Logging Categories and select Administrative and Operational audit. |
| pxGrid Administrator Audit | The pxGrid Administrator Audit report provides details of the pxGrid administration actions, such as client registration, client deregistration, client approval, topic creation, topic deletion, publisher-subscriber addition, and publisher-subscriber deletion on the Primary PAN.

Every record has the name of the administrator who has performed the action on the node.

You can filter the pxGrid Administrator Audit report based on the administrator and message criteria. | — |
| Secure Communications Audit | The Secure Communications Audit report provides auditing details about security-related events in Cisco ISE Admin CLI, which includes authentication failures, possible break-in attempts, SSH logins, failed passwords, SSH logouts, invalid user accounts, and so on. | — |
| User Change Password Audit | The User Change Password Audit report displays verification about employees' password changes. | |
| Device Administration | | |

| Report Name | Description | Logging Category |
|--------------------------|---|--|
| TACACS Accounting | The TACACS Accounting report provides accounting details for a device session. It displays information related to the generated and logged time of the users and devices. | Choose Administration > System > Logging > Logging Categories , and click TACACS Accounting . |
| Diagnostics | | |
| AAA Diagnostics | <p>The AAA Diagnostics report provides details of all the network sessions between Cisco ISE and users. If users cannot access the network, you can review this report to identify trends and identify whether the issue is isolated to a particular user or indicative of a more widespread problem.</p> <p>Note Sometimes ISE will silently drop the Accounting Stop request of an endpoint if user authentication is in progress. However, ISE starts acknowledging all the accounting requests after user authentication is completed.</p> | Choose Administration > System > Logging > Logging Categories , and select the following logging categories: Policy Diagnostics, Identity Stores Diagnostics, Authentication Flow Diagnostics, and RADIUS Diagnostics . |
| AD Connector Operations | <p>The AD Connector Operations report provides log of operations performed by the AD Connector, such as Cisco ISE Server password refresh, Kerberos tickets management, DNS queries, DC discovery, LDAP, RPC Connections management, and so on.</p> <p>If some AD failures are encountered, you can review the details in this report to identify the possible causes.</p> | Choose Administration > System > Logging > Logging Categories , and select AD Connector . |
| Endpoint Profile Changes | The Top Authorization by Endpoint (MAC address) report displays how many times each endpoint MAC address was authorized by Cisco ISE to access the network. | In the Cisco ISE GUI, click the Menu icon (☰) and choose Administration > System > Logging > Logging Categories , and select Passed Authentications and Failed Attempts . |

| Report Name | Description | Logging Category |
|----------------|---|------------------|
| Health Summary | <p>The Health Summary report provides details similar to the Dashboard. However, the Dashboard only displays data for the past 24 hours. Also, you can review more historical data using this report.</p> <p>You can evaluate this data to see consistent patterns in data. For example, you would expect heavier CPU usage when most employees start their work days. If you see inconsistencies in these trends, you can identify potential problems.</p> <p>The CPU Usage table lists the percentage of CPU usage for the different Cisco ISE functions. The output of the show cpu usage CLI command is presented in this table and you can correlate these values with the issues in your deployment to identify possible causes.</p> | — |
| ISE Counters | <p>The ISE Counters report lists the threshold values for various attributes. The values for these different attributes are collected at different intervals and the data is presented in a tabular format; one at 5-minute interval and another after 5 minutes.</p> <p>You can evaluate this data to see the trend, and if you find values that are higher than the threshold, you can correlate this information with the issues in your deployment to identify possible causes.</p> <p>By default, Cisco ISE collects the values for these attributes. You can choose to disable this data collection from the Cisco ISE CLI using the application configure ise command. Choose option 14 to enable or disable counter attribute collection.</p> | — |


| Report Name | Description | Logging Category |
|---------------------------|--|------------------|
| Key Performance Metrics | <p>The Key Performance Metrics report provides statistical information about the number of endpoints that connect to your deployment and the amount of RADIUS requests that are processed by each of the PSNs on an hourly basis. This report lists the average load on the server, average latency per request, and the average transactions per second.</p> | — |
| Misconfigured NAS | <p>The Misconfigured NAS report provides information about NADs with inaccurate accounting frequency, typically when sending accounting information frequently. If you have taken corrective actions and fix the misconfigured NADs, the report displays fixed acknowledgment in the report.</p> <p>Note RADIUS Suppression should be enabled to run this report.</p> | — |
| Misconfigured Supplicants | <p>The Misconfigured Supplicants report provides a list of misconfigured supplicants along with the statistics because of failed attempts that are performed by a specific supplicant. If you have taken corrective actions and fix the misconfigured supplicant, the report displays fixed acknowledgment in the report.</p> <p>Note RADIUS Suppression should be enabled to run this report.</p> | — |

| Report Name | Description | Logging Category |
|-------------------------------|---|--|
| Network Device Session Status | <p>The Network Device Session Status Summary report enables you to display switch configuration without logging in to the switch directly.</p> <p>Cisco ISE accesses these details using an SNMP query and requires that your network devices are configured with SNMP v1 or v2c.</p> <p>If a user is experiencing network issues, this report can help you identify if the issue is related to switch configuration or with Cisco ISE.</p> | — |
| OCSP Monitoring | <p>The OCSP Monitoring Report specifies the status of the Online Certificate Status Protocol (OCSP) services. It identifies whether Cisco ISE can successfully contact a certificate server, and provides certificate status auditing. It also provides a summary of all the OCSP certificate-validation operations performed by Cisco ISE. It retrieves information related to the good and revoked primary and secondary certificates from the OCSP server. Cisco ISE caches the responses and utilizes them for generating subsequent OCSP Monitoring Reports. In the event the cache is cleared, it retrieves information from the OCSP server.</p> | Choose Administration > System > Logging > Logging Categories , and select System Diagnostics . |
| RADIUS Errors | <p>The RADIUS Errors report enables you to check for RADIUS Requests Dropped (authentication or accounting requests that are discarded from unknown Network Access Device), EAP connection time outs, and unknown NADs.</p> <p>Note You can view the report only for the past 5 days.</p> | Choose Administration > System > Logging > Logging Categories , and select Failed Attempts . |

| Report Name | Description | Logging Category |
|----------------------------|---|--|
| System Diagnostics | <p>The System Diagnostic report provides details about the status of the Cisco ISE nodes. If a Cisco ISE node is unable to register, you can review this report to troubleshoot the issue.</p> <p>This report requires that you first enable several diagnostic logging categories. Collecting these logs can negatively impact Cisco ISE performance. So, these categories are not enabled by default, and you should enable them just long enough to collect the data. Otherwise, they are automatically disabled after 30 minutes.</p> | <p>Choose Administration > System > Logging > Logging Categories, and select the following logging categories: Internal Operations Diagnostics, Distributed Management, and Administrator Authentication and Authorization.</p> |
| Endpoints and Users | | |
| Authentication Summary | <p>The Authentication Summary report is based on the RADIUS authentications. It enables you to identify the most common authentications and the reason for authentication failures, if any. For example, if one Cisco ISE server is handling significantly more authentications than others, you might want to reassign users to different Cisco ISE servers to better balance the load.</p> <p>Note Because the Authentication Summary report or dashboard collects and displays the latest data corresponding to failed or passed authentications, the contents of the report appear after a delay of a few minutes.</p> | — |

| Report Name | Description | Logging Category |
|-----------------------------------|---|--|
| Client Provisioning | <p>The Client Provisioning report indicates the client provisioning agents applied to particular endpoints. You can use this report to verify the policies applied to each endpoint, and in turn, use this to verify whether the endpoints have been correctly provisioned.</p> <p>Note The MAC address of an endpoint is not displayed in the Endpoint ID column if the endpoint does not connect with ISE (no session is established), or if a Network Address Translation (NAT) address is used for the session.</p> | Choose Administration > System > Logging > Logging Categories , and select Posture and Client Provisioning Audit and Posture and Client Provisioning Diagnostics . |
| Current Active Sessions | <p>The Current Active Sessions report enables you to export a report with details about who is on the network within a specified time period.</p> <p>If a user isn't getting network access, you can see whether the session is authenticated or terminated, or if there is another problem with the session.</p> | — |
| External Mobile Device Management | <p>The External Mobile Device Management report provides details about integration between Cisco ISE and the external Mobile Device Management (MDM) server.</p> <p>You can use this report to see which endpoints have been provisioned by the MDM server without logging into the MDM server directly. It also displays information such as registration and MDM-compliance status.</p> | Choose Administration > System > Logging > Logging Categories and select MDM. |

| Report Name | Description | Logging Category |
|---------------------------------|--|--|
| Passive ID | <p>The Passive ID report enables you to monitor the state of WMI connection to the domain controller and gather statistics related to it (such as amount of notifications received, amount of user login/logouts per second etc.)</p> <p>Note Sessions authenticated by this method do not have authentication details in the report.</p> | Choose Administration > System > Logging > Logging Categories and select Identity Mapping. |
| Manual Certificate Provisioning | The Manual Certificate Provisioning report lists all the certificates that are provisioned manually via the certificate provisioning portal. | — |
| Posture Assessment by Condition | The Posture Assessment by Condition report enables you to view records based on the posture policy condition configured in ISE to validate that the most up-to-date security settings or applications are available on client machines. | — |
| Posture Assessment by Endpoint | The Posture Assessment by Endpoint report provides detailed information, such as the time, status, and PRA Action, of an endpoint. You can click Details to view further information of an endpoint. | — |
| Profiled Endpoints Summary | <p>The Profiled Endpoints Summary report provides profiling details about endpoints that are accessing the network.</p> <p>Note For endpoints that do not register a session time, such as a Cisco IP-Phone, the term Not Applicable is shown in the Endpoint session time field.</p> | Choose Administration > System > Logging > Logging Categories and select Profiler. |

| Report Name | Description | Logging Category |
|--------------------------------|---|--|
| RADIUS Accounting | <p>The RADIUS Accounting report identifies how long users have been on the network. If users are losing network access, you can use this report to identify whether Cisco ISE is the cause of the network connectivity issues.</p> <p>Note Radius accounting interim updates are included in the RADIUS Accounting report if the interim updates contain information about the changes to the IPv4 or IPv6 addresses for the given sessions.</p> | <p>Choose Administration > System > Logging > Logging Categories and select RADIUS Accounting.</p> <p>In the Cisco ISE GUI, click the Menu icon () and choose Administration > System > Logging > Logging Categories and select RADIUS Accounting.</p> |
| RADIUS Authentications | <p>The RADIUS Authentications report enables you to review the history of authentication failures and successes. If users cannot access the network, you can review the details in this report to identify possible causes.</p> | <p>Choose Administration > System > Logging > Logging Categories and select these logging categories: Passed Authentications and Failed Attempts.</p> |
| Registered Endpoints | <p>The Registered Endpoints report displays all personal devices registered by employees.</p> | — |
| Rejected Endpoints | <p>The Rejected Endpoints report lists all rejected or released personal devices that are registered by employees. The data for this report will be available only when you install the Plus license.</p> | — |
| Supplicant Provisioning | <p>The Supplicant Provisioning report provides details about the supplicants provisioned to employee's personal devices.</p> | Posture and Client Provisioning Audit |
| Top Authorizations by Endpoint | <p>The Top Authorization by Endpoint (MAC address) report displays how many times each endpoint MAC address was authorized by Cisco ISE to access the network.</p> | Passed Authentications, Failed Attempts |

| Report Name | Description | Logging Category |
|----------------------------|--|---|
| Top Authorizations by User | The Top Authorization by User report displays how many times each user was authorized by Cisco ISE to access the network. | Passed Authentications, Failed Attempts |
| Guest | | |
| AUP Acceptance Status | The AUP Acceptance Status report provides details of AUP acceptances from all the Guest portals. | Choose Administration > System > Logging > Logging Categories and select Guest. |
| Guest Accounting | The Guest Accounting report is a subset of the RADIUS Accounting report. All users assigned to the Activated Guest or Guest identity groups appear in this report. | — |

| Report Name | Description | Logging Category |
|----------------------------|---|--|
| Master Guest Report | <p>The Master Guest Report combines data from various Guest Access reports and enables you to export data from different reporting sources. The Master Guest report also provides details about the websites that guest users are visiting. You can use this report for security auditing purposes to demonstrate when guest users accessed the network and what they did on it.</p> <p>You must also enable HTTP inspection on the network access device (NAD) used for guest traffic. This information is sent back to Cisco ISE by the NAD.</p> <p>To check when the clients reach the maximum simultaneous sessions limit, from the Admin portal, choose Administration > System > Logging > Logging Categories and do the following:</p> <ol style="list-style-type: none"> 1. Increase the log level of "Authentication Flow Diagnostics" logging category from WARN to INFO. 2. Change LogCollector Target from Available to Selected under the "Logging Category" of AAA Diagnostics. | Choose Administration > System > Logging > Logging Categories and select Passed Authentications. |
| My Devices Login and Audit | The My Devices Login and Audit report provides details about the login activities and the operations performed by the users on the devices in My Devices Portal. | Choose Administration > System > Logging > Logging Categories and select My Devices. |

| Report Name | Description | Logging Category |
|-------------------------|--|---|
| Sponsor Login and Audit | <p>The Sponsor Login and Audit report provides details of guest users' login, add, delete, enable, suspend and update operations and the login activities of the sponsors at the sponsors portal.</p> <p>If guest users are added in bulk, they are visible under the column 'Guest Users.' This column is hidden by default. On export, these bulk users are also present in the exported file.</p> | Choose Administration > System > Logging > Logging Categories and select Guest. |
| SXP | | |
| SXP Binding | The SXP Binding report provides information about the IP-SGT bindings that are exchanged over SXP connection. | — |
| SXP Connection | You can use this report to monitor the status of an SXP connection and gather information related to it, such as peer IP, SXP node IP, VPN name, SXP mode, and so on. | — |
| Trustsec | | |
| RBACL Drop Summary | <p>The RBACL Drop Summary report is specific to the TrustSec feature, which is available only with an Advanced Cisco ISE license.</p> <p>This report also requires that you configure the network devices to send NetFlow events for dropped events to Cisco ISE.</p> <p>If a user violates a particular policy or access, packets are dropped and indicated in this report.</p> <p>Note Flows for RBACL dropped packets are available only with the Cisco Catalyst 6500 series switches.</p> | — |

| Report Name | Description | Logging Category |
|---------------------------|---|------------------|
| Top N RBACL Drops By User | <p>The Top N RBACL Drops By User report is specific to the TrustSec feature, which is available only with an Advanced Cisco ISE license.</p> <p>This report also requires that you configure the network devices to send NetFlow events for dropped events to Cisco ISE.</p> <p>This report displays policy violations (based on packet drops) by specific users.</p> <p>Note Flows for RBACL dropped packets are available only with the Cisco Catalyst 6500 series switches.</p> | — |
| TrustSec ACI | <p>This report lists the SGTs and SXP mappings that are synchronized with the IEPGs, EEPGs, endpoints, and subnet configuration of APIC. These details are displayed only if the TrustSec APIC integration feature is enabled.</p> | — |

| Report Name | Description | Logging Category |
|----------------------------------|-------------|------------------|
| TrustSec Deployment Verification | | — |

| Report Name | Description | Logging Category |
|-------------|---|------------------|
| | <p>You can use this report to verify whether the latest TrustSec policies are deployed on all network devices or if there are any discrepancies between the policies configured in Cisco ISE and the network devices.</p> <p>Click the Details icon to view the results of the verification process. You can view the following details:</p> <ul style="list-style-type: none"> • When the verification process started and completed • Whether the latest TrustSec policies are successfully deployed on the network devices. You can also view the names and IP addresses of the network devices on which the latest TrustSec policies are deployed. • Whether if there are any discrepancies between the policies configured in Cisco ISE and the network devices. It displays the device name, IP address, and the corresponding error message for each policy difference. <p>You can view the TrustSec Deployment Verification alarms in the Alarms dashlet (under Work Centers > TrustSec > Dashboard and Home > Summary).</p> <p>Note</p> <ul style="list-style-type: none"> • The time taken for reporting depends on the number of network devices and TrustSec groups in your deployment. • The error message length in the TrustSec Deployment Verification report is currently limited | |

| Report Name | Description | Logging Category |
|-----------------------------------|--|---|
| | to 480 characters. Error messages with more than 480 characters will be truncated and only the first 480 characters will be displayed in the report. | |
| Trustsec Policy Download | This report lists the requests sent by the network devices for policy (SGT/SGACL) download and the details sent by ISE. If the Workflow mode is enabled, the requests can be filtered for production or staging matrix. | To view this report, you must do the following: <ol style="list-style-type: none"> 1. Choose Administration > System > Logging > Logging Categories. 2. Choose AAA Diagnostics > RADIUS Diagnostics. 3. Set the Log Severity Level to DEBUG for RADIUS Diagnostics. |
| Threat Centric NAC Service | | |
| Adapter Status | The Adapter Status report displays the status of the threat and vulnerability adapters. | — |
| COA Events | When a vulnerability event is received for an endpoint, Cisco ISE triggers CoA for that endpoint. The CoA Events report displays the status of these CoA events. It also displays the old and new authorization rules and the profile details for these endpoints. | — |
| Threat Events | The Threat Events report provides a list of all the threat events that Cisco ISE receives from the various adapters that you have configured. | — |

| Report Name | Description | Logging Category |
|--------------------------|--|------------------|
| Vulnerability Assessment | The Vulnerability Assessment report provides information about the assessments that are happening for your endpoints. You can view this report to check if the assessment is happening based on the configured policy. | — |



PART VII

Reference

- [Administration User Interface Reference](#), on page 953
- [Guest Portal Settings](#), on page 923
- [Sponsor Portal Application Settings](#), on page 939
- [Global Settings](#), on page 946
- [Web Portals Customization Reference](#), on page 1067
- [Policy User Interface Reference](#), on page 1081
- [Operations User Interface Reference](#), on page 1149
- [Network Access Flows](#), on page 1169
- [Switch and Wireless LAN Controller Configuration Required to Support Cisco ISE Functions](#), on page 1177
- [Supported Management Information Bases for Cisco ISE Endpoint Profiler](#), on page 1189

Guest Portal Settings

Portal Identification Settings

The navigation path for these settings is **Work Centers > Guest Access > Portals & Components > Guest Portals or Sponsor Portals > Create, Edit or Duplicate > Guest Portals or Sponsor Portals Settings and Customization**.

- **Portal Name:** Enter a unique portal name to access this portal. Do not use this portal name for any other Sponsor, Guest, or nonguest portals, such as Blacklist, Bring Your Own Device (BYOD), Client Provisioning, Mobile Device Management (MDM), or My Devices portals.

This name appears in the authorization profile portal selection for redirection choices. It is applied to the list of portals for easy identification among other portals.

- **Description:** Optional.
- **Portal Test URL:** A system-generated URL displays as a link after you click **Save**. Use it to test the portal.

Click the link to open a new browser tab that displays the URL for this portal. Policy Services Node (PSN) with Policy Services must be turned on. If Policy Services are disabled, the PSN only displays the Admin portal.



Note The test portal does not support RADIUS sessions, so you won't see the entire portal flow for all portals. BYOD and Client Provisioning are examples of portals that depend on RADIUS sessions. For example, a redirect to an external URL will not work. If you have more than one PSN, Cisco ISE chooses the first active PSN.

- **Language File:** Each portal type supports 15 languages by default, which are available as individual properties files bundled together in a single zipped language file. Export or import the zipped language file to use with the portal. The zipped language file contains all the individual language files that you can use to display text for the portal.

The language file contains the mapping to the particular browser locale setting along with all of the string settings for the entire portal in that language. A single language file contains all the supported languages, so that it can easily be used for translation and localization purposes.

If you change the browser locale setting for one language, the change is applied to all the other end-user web portals. For example, if you change the French.properties browser locale from fr,fr-fr,fr-ca to fr,fr-fr in the Hotspot Guest portal, the changes also apply to the My Devices portal.

An alert icon displays when you customize any of the text on the **Portal Page Customizations** tab. The alert message reminds you that any changes made to one language while customizing the portal must also be added to all the supported languages properties files. You can manually dismiss the alert icon using the drop-down list option; or it is automatically dismissed after you import the updated zipped language file.

Portal Settings for Hotspot Guest Portals

The navigation path for these settings is **Work Centers > Guest Access > Portals & Components > Guest Portals > Create, Edit or Duplicate > Portal Behavior and Flow Settings > Portal Settings**.

- **HTTPS Port:** Enter a port value between 8000 to 8999; the default value is 8443 for all the default portals, except the Blacklist Portal, which is 8444. If you upgraded with port values outside this range, they are honored until you modify this window. If you modify this window, update the port setting to comply with this restriction.

If you assign ports used by a non-guest (such as My Devices) portal to a guest portal, an error message appears.

For posture assessments and remediation only, the Client Provisioning portal also uses ports 8905 and 8909. Otherwise, it uses the same ports assigned to the Guest portal.

Portals assigned to the same HTTPS port can use the same Gigabit Ethernet interface or another interface. If they use the same port and interface combination, they must use the same certificate group tag. For example:

- Valid combinations include, using the Sponsor portal as an example:
 - Sponsor portal: Port **8443**, Interface **0**, Certificate tag **A** and My Devices portal: Port **8443**, Interface **0**, Certificate group **A**.
 - Sponsor portal: Port **8443**, Interface **0**, Certificate group **A** and My Devices portal: Port **8445**, Interface **0**, Certificate group **B**.
 - Sponsor portal: Port **8444**, Interface **1**, Certificate group **A** and Blacklist portal: Port **8444**, Interface **0**, Certificate group **B**.
- Invalid combinations include:
 - Sponsor portal: Port **8443**, Interface **0**, Certificate group **A** and My Devices portal: **8443**, Interface **0**, Certificate group **B**.
 - Sponsor portal: Port **8444**, Interface **0**, Certificate tag **A** and Blacklist portal: Port **8444**, Interface **0**, Certificate group **A**.



Note We recommend that you use interface 0 for Guest services for best performance. You can either configure only interface 0 in the **Portal Settings**, or you can use the CLI command **ip host** to map a hostname or FQDN to the IP address of interface 0.

- **Allowed Interfaces:** Select the PSN interfaces which a PAN can use to run a portal. When a request to open a portal is made on the PAN, the PAN looks for an available allowed port on the PSN. You must configure the Ethernet interfaces using IP addresses on different subnets.

These interfaces must be available on all the PSNs, including VM-based ones, that have Policy Services turned on. This is a requirement because any of these PSNs can be used for the redirect at the start of the guest session.

- The Ethernet interfaces must use IP addresses on different subnets.
- The interfaces you enable here must be available on all your PSNs, including VM-based ones when Policy Services turned on. This is required because any of these PSNs can be used for a redirect at the start of the guest session.
- The portal certificate Subject Name or Alternate Subject Name must resolve to the interface IP address.
- Configure **ip host x.x.x.x yyy.domain.com** in Cisco ISE CLI to map the secondary interface IP address to the FQDN, which is used to match the certificate Subject Name or Alternate Subject Name.
- If only the bonded NIC is selected, when the PSN attempts to configure the portal it first attempts to configure the Bond interface. If that is not successful, perhaps because there was no bond setup on that PSN, then the PSN logs an error and exits. The PSN will not try to start the portal on the physical interface.

- **NIC Teaming or bonding** is a configuration option that allows you to configure two individual NICs for high availability (fault tolerance). If one of the NICs fails, the other NIC that is part of the bonded connection continues the connection. A NIC is selected for a portal based in the **Portal Settings** configuration. If both physical NICs and the corresponding bonded NIC are configured, when the PSN attempts to configure the portal, it first attempts to connect to the Bond interface. If that is not successful, perhaps because there was no bond setup on that PSN, then the PSN attempts to start the portal on the physical interface.

- **Certificate Group tag:** Pick a certificate group tag that specifies the certificate to be used for the portal's HTTPS traffic.

- **Endpoint Identity Group:** Choose an endpoint identity group to track guest devices. Cisco ISE provides the **GuestEndpoints** endpoint identity group to use as a default. You can also create more endpoint identity groups if you choose to not use the default.

Choose an endpoint identity group to track employee devices. Cisco ISE provides the **RegisteredDevices** endpoint identity group to use as a default. You can also create more endpoint identity groups if you choose to not use the default.

- **Purge Endpoints in this Identity Group when they Reach __ Days:** Specify the number of days after which the device is purged from the Cisco ISE database. Purging is done on a daily basis and the purge activity is synchronized with the overall purge timing. The change is applied globally for this endpoint identity group.

If changes are made to the Endpoint Purge Policy based on other policy conditions, this setting is no longer available for use.

- **Display Language**

- **Use Browser Locale:** Use the language specified in the client browser's locale setting as the display language of the portal. If browser locale's language is not supported by Cisco ISE, then the **Fallback Language** is used as the language portal.

- **Fallback Language:** Choose the language to use when the language cannot be obtained from the browser locale, or if the browser locale language is not supported by Cisco ISE.

- **Always Use:** Choose the display language to use for the portal. This setting overrides the **User Browser Locale** option.

Acceptable Use Policy (AUP) Page Settings for Hotspot Guest Portals

The navigation path for this page is **Work Centers > Guest Access > Portals & Components > Guest Portals > Create, Edit or Duplicate > Portal Behavior and Flow Settings > Acceptable Use Policy (AUP) Page Settings**.

- **Include an AUP Page:** Display your company's network-usage terms and conditions on a separate page to the user.
- **Require an Access Code:** Assign an access code as the login credential that multiple guests should use to gain access to the network. An access code is primarily a locally known code that is given to physically

present guests (either visually via a whiteboard or verbally by a lobby ambassador). It would not be known and used by someone outside the premises to access the network.

You can use this option in addition to the usernames and passwords that are provided as the login credentials to individual guests.

- **Require scrolling to end of AUP**—Ensure that the user has read the AUP completely. The **Accept** button activates only after the user has scrolled to the end of the AUP. Configure when the AUP appears to the user.

When configuring the Hotspot Guest Portals flow, the AUP access code is reliant on Endpoint Identity Group device registration.

The AUP access code page will appear only after the MAC address has been removed from the Endpoint Identity Group tied to the hotspot portal configuration. An endpoint is either manually deleted from the database through the Context Visibility page on Cisco ISE, or it is purged by way of the Endpoint Purge feature and configured endpoint purge policies.

Post-Access Banner Page Settings for Hotspot Portals

The navigation path for this page is **Work Centers > Guest Access > Portals & Components > Guest Portals > Create, Edit or Duplicate > Portal Behavior and Flow Settings > Post-Access Banner Page Settings**.

Use this setting to inform guests of their access status and any other additional actions, if required.

| Field | Usage Guidelines |
|--|--|
| Include a Post-Access Banner page | Display additional information after the guests are successfully authenticated and before they are granted network access. |

Portal Settings for Credentialed Guest Portals

The navigation path for these settings is: **Work Centers > Guest Access > Portals & Components > Guest Portals > Create, Edit or Duplicate > Portal Behavior and Flow Settings > Portal Settings**.

- **HTTPS Port**: Enter a port value between 8000 to 8999; the default value is 8443 for all the default portals, except the Blacklist Portal, which is 8444. If you upgraded with port values outside this range, they are honored until you modify this window. If you modify this window, update the port setting to comply with this restriction.

If you assign ports used by a non-guest (such as My Devices) portal to a guest portal, an error message appears.

For posture assessments and remediation only, the Client Provisioning portal also uses ports 8905 and 8909. Otherwise, it uses the same ports assigned to the Guest portal.

Portals assigned to the same HTTPS port can use the same Gigabit Ethernet interface or another interface. If they use the same port and interface combination, they must use the same certificate group tag. For example:

- Valid combinations include, using the Sponsor portal as an example:

- Sponsor portal: Port **8443**, Interface **0**, Certificate tag **A** and My Devices portal: Port **8443**, Interface **0**, Certificate group **A**.
- Sponsor portal: Port **8443**, Interface **0**, Certificate group **A** and My Devices portal: Port **8445**, Interface **0**, Certificate group **B**.
- Sponsor portal: Port **8444**, Interface **1**, Certificate group **A** and Blacklist portal: Port **8444**, Interface **0**, Certificate group **B**.
- Invalid combinations include:
 - Sponsor portal: Port **8443**, Interface **0**, Certificate group **A** and My Devices portal: **8443**, Interface **0**, Certificate group **B**.
 - Sponsor portal: Port **8444**, Interface **0**, Certificate tag **A** and Blacklist portal: Port **8444**, Interface **0**, Certificate group **A**.



Note We recommend that you use interface 0 for Guest services for best performance. You can either configure only interface 0 in the **Portal Settings**, or you can use the CLI command **ip host** to map a hostname or FQDN to the IP address of interface 0.

- **Allowed Interfaces:** Select the PSN interfaces which a PAN can use to run a portal. When a request to open a portal is made on the PAN, the PAN looks for an available allowed port on the PSN. You must configure the Ethernet interfaces using IP addresses on different subnets.

These interfaces must be available on all the PSNs, including VM-based ones, that have Policy Services turned on. This is a requirement because any of these PSNs can be used for the redirect at the start of the guest session.

- The Ethernet interfaces must use IP addresses on different subnets.
- The interfaces you enable here must be available on all your PSNs, including VM-based ones when Policy Services turned on. This is required because any of these PSNs can be used for a redirect at the start of the guest session.
- The portal certificate Subject Name or Alternate Subject Name must resolve to the interface IP address.
- Configure **ip host x.x.x.x yyy.domain.com** in Cisco ISE CLI to map the secondary interface IP address to the FQDN, which is used to match the certificate Subject Name or Alternate Subject Name.
- If only the bonded NIC is selected, when the PSN attempts to configure the portal it first attempts to configure the Bond interface. If that is not successful, perhaps because there was no bond setup on that PSN, then the PSN logs an error and exits. The PSN will not try to start the portal on the physical interface.
- NIC Teaming or bonding is a configuration option that allows you to configure two individual NICs for high availability (fault tolerance). If one of the NICs fails, the other NIC that is part of the bonded connection continues the connection. A NIC is selected for a portal based in the **Portal Settings** configuration. If both physical NICs and the corresponding bonded NIC are configured, when the PSN attempts to configure the portal, it first attempts to connect to the Bond interface. If that is not

successful, perhaps because there was no bond setup on that PSN, then the PSN attempts to start the portal on the physical interface.

- The portal certificate Subject Name or Alternate Subject Name must resolve to the interface IP address.
- **Authentication Method:** Choose which identity source sequence or Identity Provider (IdP) to use for user authentication. The identity source sequence is a list of identity stores that are searched in sequence to verify user credentials.

Cisco ISE includes a default identity source sequence for sponsor portals, `Sponsor_Portal_Sequence`.

To configure IdP, choose **Administration > Identity Management > External Identity Sources > SAML Id Providers**.

To configure an identity source sequence, choose **Administration > Identity Management > Identity Source Sequences**.

- **Employees Using this Portal as Guests Inherit Login Options from:** Choose the Guest Type that employees are assigned when they log on to this portal. The employee's endpoint data is stored in the endpoint identity group configured in that guest type for the attribute **Store device information in endpoint identity group**. No other attributes from the associated guest type are inherited.
- **Display Language**
 - **Use Browser Locale:** Use the language specified in the client browser's locale setting as the display language of the portal. If browser locale's language is not supported by Cisco ISE, then the **Fallback Language** is used as the language portal.
 - **Fallback Language:** Choose the language to use when the language cannot be obtained from the browser locale, or if the browser locale language is not supported by Cisco ISE.
 - **Always Use:** Choose the display language to use for the portal. This setting overrides the **User Browser Locale** option.

Login Page Settings for Credentialed Guest Portals

The navigation path for this page is: **Work Centers > Guest Access > Portals & Components > Guest Portals > Create, Edit or Duplicate > Portal Behavior and Flow Settings > Login Page Settings**.

- **Require an Access Code:** Assign an access code as the login credential that multiple guests should use to gain access to the network. An access code is primarily a locally known code that is given to physically present guests (either visually via a whiteboard or verbally by a lobby ambassador). It would not be known and used by someone outside the premises to access the network.

You can use this option in addition to the usernames and passwords that are provided as the login credentials to individual guests.

- **Maximum Failed Login Attempts Before Rate Limiting:** Specify the number of failed login attempts from a single browser session before Cisco ISE starts to throttle that account. This does not cause an account lockout. The throttled rate is configured in **Time between login attempts when rate limiting**.

- **Time Between Login Attempts when Rate Limiting:** Set the length of time in minutes that a user must wait before attempting to log in again (throttled rate), after failing to log in the number of times defined in **Maximum failed login attempts before rate limiting**.
- **Include an AUP:** Add a acceptable use policy window to the flow. You can add the AUP to the window, or link to another window.
- **Allow Guests to Create their Own Accounts:** Provide an option on this portal's Login page for guests to register themselves. If this option is not selected, sponsors create guest accounts. Enabling this also enables tabs on this page for you to configure **Self-Registration Page Settings** and **Self-Registration Success Page Settings**.
If guests choose this option, they are presented with the Self-Registration form where they can enter the requested information to create their own guest accounts.
- **Allow guests to change password after login:** Allow guests to change their password after successfully authenticating and accepting the AUP, if it is required. If guests change their passwords, sponsors cannot provide guests with their login credentials if lost. The sponsor can only reset the guest's password back to a random password.
- **Allow the following identity-provider guest portal to be used for login:** Checking this option and selecting a SAML Id identity provider adds a link for that SAML Id to this portal. This sub-portal can be configured to look like the SAML IDP that the user is providing credentials for.

Self-Registration Page Settings

The navigation path for this page is **Work Centers > Guest Access > Portal & Components > Guest Portals > Create, Edit or Duplicate > Portal Behavior and Flow Settings > Self Registration Page Settings**. Use these settings to enable guests to register themselves and specify the information that they must provide on the Self-Registration form.

- **Assign self-registered guests to guest type:** Choose the guest type to which all the self-registered guests using this portal are assigned.
- **Account valid for:** Specify the duration for the account in days, hours, or minutes after which the account expires unless you or the sponsor extend the account duration in the Sponsor portal.
- **Require a registration code for self registration:** Assign a code that the self-registering guests must enter to successfully submit their Self-Registration form. Similar to the access code, the registration code is provided to the guest offline to prevent someone who is outside the premises from accessing the system.
- **Fields to include:** Check the fields that you want to display on the Self-Registration form. Then check which fields are mandatory for the guests to complete in order to submit the form and receive a guest account. You may want to require fields such as **SMS Service Provider** and **Person being Visited** to gather important information from self-registering guests.
 - **Location:** Enter locations that the self-registering guests can select at registration time using the list of locations that you have defined. This automatically assigns the related time zones as the valid access times for these guests. Use clear location names to avoid ambiguity during selection (for example, Boston Office, 500 Park Ave New York, Singapore).

If you plan to restrict guest access by time of day, the time zone is used to determine that time. Unless all your time-access controlled guests are in the San Jose time zone, then create a time zone for your locale. If there is only one location, it is automatically assigned as the default location, and

this field does not display in the portal for guests to view. Also, **Location** is disabled in the list of **Fields to include**.

- **SMS Service Provider:** Select which SMS providers to display on the Self-Registration form to enable self-registering guests to choose their own SMS provider. You can then use the guest's SMS service to send them SMS notifications, which minimize expenses for your company. If you only selected one SMS provider for the guest to use, this field will not display on the Self-Registration form.
- **Person being visited:** This is a text field, so if you want to use it, instruct your guests what kind of information to enter into this field.
- **Custom Fields:** Select the custom fields that you previously created to collect more data from the self-registering guests. Then check which fields are mandatory for the guests to complete in order to submit the Self-Registration form and receive a guest account. These fields are listed in alphabetical order by name. You create these fields on **Work Centers > Guest Access > Settings > Custom Fields** to add more custom fields.
- **Include an AUP:** Display your company's network-usage terms and conditions, either as text on the page currently being displayed for the user or as a link that opens a new tab or window with AUP text.

- **Require acceptance:** Ensure that the user has read the AUP completely. This configures an **Accept** button on the self-registration page. If you configured AUP **as on page**, then you can also disable the Accept button until after the user has scrolled to the end of the AUP.

- **Only allow guests with an email address from:** Specify an allowed list of domains which the self-registering guests can use in **Email Address** to create email addresses, for example, cisco.com.

If you leave this field blank, any email address is valid, except for domains listed in **Do not allow guests with email address from**.

- **Do not allow guests with an email address from:** Specify a blocked list of domains which the self-registering guests cannot use in **Email Address** to create email addresses, for example, czgtgj.com.
- **Require self-registered guests to be approved:** Specify that the self-registering guests using this portal require approval from a sponsor before receiving their guest credentials. Clicking this option displays more options for how sponsors approve a self-registered guest.

- **Email approval request to:**

- **Sponsor email addresses listed below:** Enter one or more email addresses of sponsors designated as approvers, or a mailer, to which all guest approval requests should be sent. If the email address is not valid, approval fails.
- **Person being visited: Require sponsor to provide credentials for authentication** field is displayed, and the **Required** option in **Fields to include** is enabled (if it was previously disabled). These fields are displayed on the Self-Registration form requesting this information from the self-registering guests. If the email address is not valid, approval fails.

- **Approve/Deny Link Settings:**

- **Links are valid for:** You can set an expiration period for the account approval links.
- **Require sponsor to provide credentials for authentication:** Check this to force the sponsor to enter credentials to approve the account, even if it is not required by the configuration in

this section. This field is only visible if **Require self-registered guests to be approved** is set to **person being visited**.

- **Sponsor is matched to a Sponsor Portal to verify approval privileges:** Click **Details** to select the portals that are searched to verify that the sponsor is a valid system user, a member of a sponsor group, and that the members of that group have authority to approve the account. Each sponsor portal has an identity source sequence, which is used to identify the sponsor. Portals are used in the order they are listed. The first portal in the list determines the style and customization used in the sponsor portal.

- **After registration submission, direct guest to:** Choose where the self-registered guest is directed after successfully registering.

- **Self-Registration Success page:** Direct successfully self-registered guests to the **Self-Registration Success** window, which displays the fields and messages you have specified on **Self Registration Success Page Settings**.

It may not be desirable to display all the information, because the system may be awaiting account approval (if enabled on this window) or delivering the login credentials to an email address or phone number based on the allowed list and blocked list domains specified on this window.

If you enabled **Allow guests to log in directly from the Self-Registration Success page** in **Self-Registration Success Page Settings**, successfully self-registered guests can log in directly from this window. If it is not enabled, they are directed to the portal's Login window after the **Self-Registration Success** window is displayed.

- **Login page with instructions about how to obtain login credentials:** Direct successfully self-registered guests back to the portal's Login window and display a message, such as "Please wait for your guest credentials to be delivered either via email, SMS, or print format and proceed with logging in."

To customize the default message, click the **Portal Page Customization** tab and select **Self-Registration Page Settings**.

The system may be awaiting account approval (if enabled on this window) or delivering the login credentials to an email address or phone number based on the allowed list and blocked list domains specified on this window.

- **URL:** Direct successfully self-registered guests to the specified URL while waiting for their account credentials to be delivered.

The system may be awaiting account approval (if enabled on this window) or delivering the login credentials to an email address or phone number based on the allowed list and blocked list domains specified on this window.

- **Send credential notification automatically using:**

- **Email:** Choose email as the option by which successfully self-registered guests receive their login credential information. If you choose this option, **Email address** becomes a required field in the list of **Fields to include** and you can no longer disable this option.

- **SMS:** Choose SMS as the option by which successfully self-registered guests receive their login credential information. If you choose this option, **SMS Service Provider** becomes a required field in the list of **Fields to include** and you can no longer disable this option.

Self Registration Success Page Settings

The navigation path for this page is **Work Centers > Guest Access > Portals & Components > Guest Portals > Create, Edit or Duplicate > Portal Behavior and Flow Settings > Self Registration Success Page Settings**. Use these settings to notify successfully self-registered guests of the credentials they need to gain access to the network.

| Field | Usage Guidelines |
|---|--|
| Include this information on the Self-Registration Success page | <p>Check the fields that you want to display for the successfully self-registered guests on the Self-Registration Success page.</p> <p>If sponsor approval of the guest is not required, check Username and Password to display these credentials for the guest. If sponsor approval is required, these fields are disabled, because the credentials can only be delivered to the guest after they have been approved.</p> |
| Allow guest to send information to self using | Check the options by which the successfully self-registered guest can send credential information to themselves: Print , Email , or SMS . |
| Include an AUP (on page/as link) | Display your company's network-usage terms and conditions, either as text on the window currently being displayed for the user or as a link that opens a new tab or window with AUP text. |
| Require Acceptance | Require users to accept an AUP before their account is fully enabled. The Login button is not enabled unless the user accepts the AUP. If users do not accept the AUP, they will not obtain network access. |
| Require scrolling to end of AUP | <p>This field displays if you chose the AUP on page option.</p> <p>Ensure that the user has read the AUP completely. The Accept button is enabled only after the user has scrolled to the end of the AUP.</p> |
| Allow guests to log in directly from the Self-Registration Success page | Display a Login button at the bottom of the Self-Registration Success page. This enables the guest to bypass the Login page and automatically deliver the login credentials to the portal and display the next page in the portal flow (for instance, the AUP page). |

Acceptable Use Policy (AUP) Page Settings for Credentialed Guest Portals

- **Include an AUP Page:** Display your company's network-usage terms and conditions on a separate page to the user.
- **Use Different AUP for Employees:** Display a different AUP and network-usage terms and conditions for employees only. If you choose this option, you cannot also choose **Skip AUP for employees**.
- **Skip AUP for Employees:** Employees are not required to accept an AUP before accessing the network. If you choose this option, you cannot also choose **Use different AUP for employees**.
- **Require Scrolling to End of AUP:** This option displays only if **Include an AUP on page** is enabled.

Ensure that the user has read the AUP completely. The **Accept** button activates only after the user has scrolled to the end of the AUP. Configure when the AUP appears to the user.

- **On First Login only:** Display an AUP the first time the user logs into the network or portal.
- **On Every Login:** Display an AUP every time the user logs into the network or portal.
- **Every __ Days (starting at first login):** Display an AUP periodically after the user first logs into the network or portal.

Guest Change Password Settings for Credentialed Guest Portals

Guest Change Password Settings

The navigation path for this page is **Work Centers > Guest Access > Portals & Components > Guest Portals > Create, Edit or Duplicate > Portal Behavior and Flow Settings > Guest Change Password Settings**

- **Allow guests to change password after login:** Allow guests to change their password after successfully authenticating and accepting the AUP, if it is required. If guests change their passwords, sponsors cannot provide guests with their login credentials if lost. The sponsor can only reset the guest's password back to a random password.

Guest Device Registration Settings for Credentialed Guest Portals

The navigation path for this page is **Work Centers > Guest Access > Portals & Components > Guest Portals > Create, Edit or Duplicate > Portal Behavior and Flow Settings > Guest Device Registration Settings**.

Use these settings to either ensure that Cisco ISE automatically registers guest devices when they log in to or to allow guests to manually register their devices after they log in.

The maximum number of devices is specified for each guest type in **Work Centers > Guest Access > Portals & Components > Guest Types**.

- **Automatically Register Guest Devices:** Automatically create an endpoint for the device from which the guest is accessing this portal. The endpoint is added to the endpoint identity group specified for this portal.

An authorization rule can now be created to allow access to endpoints in that identity group, so that web authentication is no longer required.

If the maximum number of registered devices is reached, the system automatically deletes the first registered device, registers the device the guest is trying to log in with, and notifies them. Choose **Work Centers > Guest Access > Portals & Components > Guest Types** to change the maximum number of devices with which a guest can register.

- **Allow Guests to Register Devices:** Guests can register their devices manually by providing a name, description and MAC address. The MAC address is associated with an endpoint identity group.

If the maximum number of registered devices is reached, the guest is required to delete at least one device before being allowed to register another device.

BYOD Settings for Credentialed Guest Portals

The navigation path for this page is **Work Centers > Guest Access > Portals & Components > Guest Portals > Create, Edit or Duplicate > Portal Behavior and Flow Settings > BYOD Settings**.

Use these settings to enable Bring Your Own Device (BYOD) functionality for non-guests, such as employees, using the Credentialed Guest portals to access your corporate network.

| Field | Usage Guidelines |
|---|---|
| Allow Employees to use Personal Devices on the Network | Add the BYOD Registration window to this portal allowing employees to go through the employee device registration process, and possibly native supplicant and certificate provisioning, depending on the settings for Client Provisioning for the employee's personal device type (for example, iOS, Android, OSX). |
| Endpoint Identity Group | Choose an endpoint identity group to track guest devices. Cisco ISE provides the GuestEndpoints endpoint identity group to use as a default. You can also create more endpoint identity groups if you choose to not use the default. |
| Allow employees to choose to get guest access only | Let employees access your guest network and avoid additional provisioning and registration that may be required to access your corporate network. |
| Display Device ID Field During Registration | Display the device ID to the user during the registration process, even though the device ID is pre-configured and cannot be changed while using the BYOD portal. |

| Field | Usage Guidelines |
|-----------------|---|
| Originating URL | <p>After successfully authenticating to the network, redirect the user's browser to the original website that the user is trying to access, if available. If not available, the Authentication Success window appears. Make sure that the redirect URL is allowed to work on port 8443 of the PSN by the access-control list on the NAD and by authorization profiles configured in Cisco ISE for that NAD.</p> <p>For Windows, MAC, and Android devices, control is given to the Self-Provisioning Wizard app, which does provisioning. Therefore, these devices are not redirected to the originating URL. However, iOS (dot1X) and unsupported devices (that are allowed network access) are redirected to this URL.</p> |
| Success page | Display a page indicating that the device registration was successful. |
| URL | After successfully authenticating to the network, redirect the user's browser to the specified URL, such as your company's website. |

Post-Login Banner Page Settings for Credentialed Guest Portals

The navigation path for this page is **Work Centers > Guest Access > Portals & Components > Guest Portals or Sponsor Portals > Create, Edit or Duplicate > Portal Behavior and Flow Settings > Post-Login Banner Page Settings**.

Use this setting to notify users (guests, sponsors or employees as applicable) of additional information after they log in successfully.

| Field | Usage Guidelines |
|----------------------------------|--|
| Include a Post-Login Banner page | Display additional information after the users successfully log in and before they are granted network access. |

Guest Device Compliance Settings for Credentialed Guest Portals

The navigation path for this page is **Work Centers > Guest Access > Portals & Components > Guest Portals > Create, Edit or Duplicate > Portal Behavior and Flow Settings > Guest Device Compliance Settings**. Use these settings to require guests, and employees using the guest portal, to undergo client provisioning of their devices in order to gain access to the network.

- **Require guest device compliance**—Redirect guests to the Client Provisioning page, which requires them to download a posture agent. This adds client provisioning to the Guest flow, where you configure posture policies for guests, such as checking for virus protection software.

If the guest is an employee using the Credentialed Guest portals to access the network and:

- If you enabled **Allow employees to use personal devices on the network** in the **BYOD Settings**, the employee is redirected to the BYOD flow and will not undergo client provisioning.
- If you enabled both **Allow employees to use personal devices on the network** and **Allow employees to choose to get guest access only** in the **BYOD Settings**, and the employee chooses guest access, they are routed to the Client Provisioning page.

VLAN DHCP Release Page Settings for Guest Portals

The navigation path for this page is **Work Centers > Guest Access > Portals & Components > Guest Portals > Create, Edit or Duplicate > Portal Behavior and Flow Settings > VLAN DHCP Release Page Settings**.

- **Enable VLAN DHCP release:** Refresh a guest's IP address for Windows devices after a VLAN change in both wired and wireless environments.

This affects the Central WebAuth (CWA) flow during final authorization, when the network access changes the guest VLAN to a new VLAN. The guest's old IP address must be released before the VLAN change, and a new guest IP address must be requested through DHCP when the guest connects to the new VLAN. The IP address release and renew operations are supported only on the Internet Explorer Browser which uses DirectX controls.

The VLAN DHCP Release option does not work on mobile devices. Instead, guests are requested to manually reset the IP address. This method varies by devices. For example, on Apple iOS devices, guests can select the Wi-Fi network and click the **Renew Lease** button.

- **Delay to Release __ Seconds:** Enter the delay to release time. We recommend a short value, because the release must occur immediately after the applet is downloaded, and before the Cisco ISE server directs the NAD to re-authenticate with a CoA request.
- **Delay to CoA __ Seconds:** Enter the time to delay Cisco ISE from executing the CoA. Provide enough time (use the default value as a guideline) to allow the applet to download and perform the IP release on the client.
- **Delay to Renew __ Seconds:** Enter the delay to renew value. This time is added to the IP release value and does not begin timing until the control is downloaded. Provide enough time (use the default value as a guideline) so that the CoA is allowed to process and the new VLAN access granted.

Authentication Success Settings for Guest Portals

The navigation path for this page is **Work Centers > Guest Access > Portals & Components > Guest Portals > Create, Edit or Duplicate > Portal Behavior and Flow Settings > Authentication Success Settings**.

These settings notify the users (guests, sponsors, or employees as applicable) of authentication success or display a URL. Under **Once authenticated, take guest to:**, configure the following fields:

- **Originating URL:** After successfully authenticating to the network, redirect the user's browser to the original website that the user is trying to access, if available. If not available, the Authentication Success

window appears. Make sure that the redirect URL is allowed to work on port 8443 of the PSN by the access-control list on the NAD and by authorization profiles configured in ISE for that NAD.

For Windows, MAC, and Android devices, control is given to the Self-Provisioning Wizard app, which does provisioning. Therefore, these devices are not redirected to the originating URL. However, iOS (dot1X) and unsupported devices (that are allowed network access) are redirected to this URL.

- **Authentication Success page:** Notification of successful authentication of the user.
- **URL:** After successfully authenticating to the network, redirect the user's browser to the specified URL, such as your company's website.



Note If you redirect a Guest to an external URL after authentication, there may be a delay while the URL address is resolved and the session is redirected. Make sure that the redirect URL is allowed to work on port 8443 of the PSN by the access-control list on the NAD and by authorization profiles configured in ISE for that NAD.

Support Information Page Settings for Guest Portals

The navigation path for this page is **Work Centers > Guest Access > Portals & Components > Guest Portals > Create, Edit or Duplicate > Portal Behavior and Flow Settings > Support Information Page Settings**.

Use these settings to display the information that your Help Desk can use to troubleshoot access issues experienced by users (guests, sponsors or employees as applicable).

| Field | Usage Guidelines |
|---|--|
| Include a Support Information Page | Display a link to an information window, such as Contact Us , on all enabled windows for the portal. |
| MAC Address | Include the MAC address of the device on the Support Information window. |
| IP Address | Include the IP address of the device on the Support Information window. |
| Browser User Agent | Include the browser details such as the product name and version, layout engine, and version of the user agent originating the request on the Support Information window. |
| Policy Server | Include the IP address of the ISE Policy Service Node (PSN) that is serving this portal on the Support Information window. |
| Failure Code | If available, include the corresponding number from the log message catalog. To view the message catalog, choose Administration > System > Logging > Message Catalog . |

| Field | Usage Guidelines |
|---|---|
| Hide Field | Do not display any field labels on the Support Information window if the information that they would contain is non-existent. For example, if the failure code is unknown, and therefore blank, do not display Failure Code , even if it is selected. |
| Display Label with no Value | Display all selected field labels on the Support Information window, even if the information that they would contain is non-existent. For example, if the failure code is unknown, display Failure Code , even if it is blank. |
| Display Label with Default Value | Display this text in any selected field on the Support Information window, if the information that they would contain is non-existent. For example, if you enter Not Available in this field, and the failure code is unknown, the Failure Code field displays Not Available . |

Sponsor Portal Application Settings

Portal Identification Settings

The navigation path for these settings is **Work Centers > Guest Access > Portals & Components > Guest Portals or Sponsor Portals > Create, Edit or Duplicate > Guest Portals or Sponsor Portals Settings and Customization**.

- **Portal Name:** Enter a unique portal name to access this portal. Do not use this portal name for any other Sponsor, Guest, or nonguest portals, such as Blacklist, Bring Your Own Device (BYOD), Client Provisioning, Mobile Device Management (MDM), or My Devices portals.

This name appears in the authorization profile portal selection for redirection choices. It is applied to the list of portals for easy identification among other portals.

- **Description:** Optional.
- **Portal Test URL:** A system-generated URL displays as a link after you click **Save**. Use it to test the portal.

Click the link to open a new browser tab that displays the URL for this portal. Policy Services Node (PSN) with Policy Services must be turned on. If Policy Services are disabled, the PSN only displays the Admin portal.



Note The test portal does not support RADIUS sessions, so you won't see the entire portal flow for all portals. BYOD and Client Provisioning are examples of portals that depend on RADIUS sessions. For example, a redirect to an external URL will not work. If you have more than one PSN, Cisco ISE chooses the first active PSN.

- **Language File:** Each portal type supports 15 languages by default, which are available as individual properties files bundled together in a single zipped language file. Export or import the zipped language file to use with the portal. The zipped language file contains all the individual language files that you can use to display text for the portal.

The language file contains the mapping to the particular browser locale setting along with all of the string settings for the entire portal in that language. A single language file contains all the supported languages, so that it can easily be used for translation and localization purposes.

If you change the browser locale setting for one language, the change is applied to all the other end-user web portals. For example, if you change the French.properties browser locale from fr,fr-fr,fr-ca to fr,fr-fr in the Hotspot Guest portal, the changes also apply to the My Devices portal.

An alert icon displays when you customize any of the text on the **Portal Page Customizations** tab. The alert message reminds you that any changes made to one language while customizing the portal must also be added to all the supported languages properties files. You can manually dismiss the alert icon using the drop-down list option; or it is automatically dismissed after you import the updated zipped language file.

Portal Settings for Sponsor Portals

Configure these settings to identify the portal and select the language files to be used for all the portal pages.

- **HTTPS Port:** Enter a port value between 8000 to 8999; the default value is 8443 for all the default portals, except the Blacklist Portal, which is 8444. If you upgraded with port values outside this range, they are honored until you modify this window. If you modify this window, update the port setting to comply with this restriction.

If you assign ports used by a non-guest (such as My Devices) portal to a guest portal, an error message appears.

For posture assessments and remediation only, the Client Provisioning portal also uses ports 8905 and 8909. Otherwise, it uses the same ports assigned to the Guest portal.

Portals assigned to the same HTTPS port can use the same Gigabit Ethernet interface or another interface. If they use the same port and interface combination, they must use the same certificate group tag. For example:

- Valid combinations include, using the Sponsor portal as an example:
 - Sponsor portal: Port **8443**, Interface **0**, Certificate tag **A** and My Devices portal: Port **8443**, Interface **0**, Certificate group **A**.
 - Sponsor portal: Port **8443**, Interface **0**, Certificate group **A** and My Devices portal: Port **8445**, Interface **0**, Certificate group **B**.

- Sponsor portal: Port **8444**, Interface **1**, Certificate group **A** and Blacklist portal: Port **8444**, Interface **0**, Certificate group **B**.
- Invalid combinations include:
 - Sponsor portal: Port **8443**, Interface **0**, Certificate group **A** and My Devices portal: **8443**, Interface **0**, Certificate group **B**.
 - Sponsor portal: Port **8444**, Interface **0**, Certificate tag **A** and Blacklist portal: Port **8444**, Interface **0**, Certificate group **A**.



Note We recommend that you use interface 0 for Guest services for best performance. You can either configure only interface 0 in the **Portal Settings**, or you can use the CLI command **ip host** to map a hostname or FQDN to the IP address of interface 0.

- **Allowed Interfaces:** Select the PSN interfaces which a PAN can use to run a portal. When a request to open a portal is made on the PAN, the PAN looks for an available allowed port on the PSN. You must configure the Ethernet interfaces using IP addresses on different subnets.

These interfaces must be available on all the PSNs, including VM-based ones, that have Policy Services turned on. This is a requirement because any of these PSNs can be used for the redirect at the start of the guest session.

- The Ethernet interfaces must use IP addresses on different subnets.
- The interfaces you enable here must be available on all your PSNs, including VM-based ones when Policy Services turned on. This is required because any of these PSNs can be used for a redirect at the start of the guest session.
- The portal certificate Subject Name or Alternate Subject Name must resolve to the interface IP address.
- Configure **ip host x.x.x.x yyy.domain.com** in Cisco ISE CLI to map the secondary interface IP address to the FQDN, which is used to match the certificate Subject Name or Alternate Subject Name.
- If only the bonded NIC is selected, when the PSN attempts to configure the portal it first attempts to configure the Bond interface. If that is not successful, perhaps because there was no bond setup on that PSN, then the PSN logs an error and exits. The PSN will not try to start the portal on the physical interface.
- NIC Teaming or bonding is a configuration option that allows you to configure two individual NICs for high availability (fault tolerance). If one of the NICs fails, the other NIC that is part of the bonded connection continues the connection. A NIC is selected for a portal based in the **Portal Settings** configuration. If both physical NICs and the corresponding bonded NIC are configured, when the PSN attempts to configure the portal, it first attempts to connect to the Bond interface. If that is not successful, perhaps because there was no bond setup on that PSN, then the PSN attempts to start the portal on the physical interface.
- **Certificate Group tag:** Pick a certificate group tag that specifies the certificate to be used for the portal's HTTPS traffic.

- **Fully Qualified Domain Name (FQDN):** Enter at least one unique FQDN or hostname for the Sponsor or MyDevices portal. For example, you can enter **sponsorportal.yourcompany.com, sponsor,** so that when the user enters either of those into a browser, the sponsor portal displays. Separate names with commas, but do not include spaces between entries.

If you change the default FQDN, then also do the following:

- Update your DNS so that the FQDN of the new URL resolves to a valid Policy Services Node (PSN) IP address. Optionally, this address could point to a load balancer virtual IP address that serves a pool of PSNs.
- To avoid certificate warning messages due to name mismatches, include the FQDN of the customized URL, or a wildcard, in the subject alternative name (SAN) attribute of the local server certificate of the Cisco ISE PSN.

- **Authentication Method:** Choose which identity source sequence or Identity Provider (IdP) to use for user authentication. The identity source sequence is a list of identity stores that are searched in sequence to verify user credentials.

Cisco ISE includes a default identity source sequence for sponsor portals, Sponsor_Portal_Sequence.

To configure IdP, choose **Administration > Identity Management > External Identity Sources > SAML Id Providers.**

To configure an identity source sequence, choose **Administration > Identity Management > Identity Source Sequences.**

- **Idle Timeout:** Enter the time in minutes that you want Cisco ISE to wait before it logs out the user if there is no activity in the portal. The valid range is from 1 to 30 minutes.
- **Allow Kerberos:** Use Kerberos to authenticate a sponsor for access to the sponsor portal. Kerberos SSO is performed inside the secure tunnel after the browser establishes the SSL connection with ISE.



Note Kerberos authentication requires the following items to be in the same domain:

- Sponsor's PC
- ISE PSN
- FQDN configured for this sponsor portal



Note Kerberos authentication is NOT supported for the Guest portal.

- **Display Language**

- **Use Browser Locale:** Use the language specified in the client browser's locale setting as the display language of the portal. If browser locale's language is not supported by Cisco ISE, then the **Fallback Language** is used as the language portal.
- **Fallback Language:** Choose the language to use when the language cannot be obtained from the browser locale, or if the browser locale language is not supported by Cisco ISE.

- **Always Use:** Choose the display language to use for the portal. This setting overrides the **User Browser Locale** option.
- **SSIDs Available to Sponsors:** Enter the names or the SSIDs (Session Service Identifiers) of the networks that a sponsor can notify guests as the correct networks to connect to for their visit.

Login Settings for Sponsor Portals

Login Page Settings for Sponsor Portals

The navigation path for this page is **Work Centers > Guest Access > Portals & Components > Sponsor Portals > Create, Edit or Duplicate > Portal Behavior and Flow Settings > Login Page Settings**.

- **Maximum Failed Login Attempts Before Rate Limiting:** Specify the number of failed login attempts from a single browser session before Cisco ISE starts to throttle that account. This does not cause an account lockout. The throttled rate is configured in **Time between login attempts when rate limiting**.
- **Time Between Login Attempts when Rate Limiting:** Set the length of time in minutes that a user must wait before attempting to log in again (throttled rate), after failing to log in the number of times defined in **Maximum failed login attempts before rate limiting**.
- **Include an AUP:** Add a acceptable use policy window to the flow. You can add the AUP to the window, or link to another window.

Acceptable Use Policy (AUP) Settings for Sponsor Portals

The navigation path for this page is **Work Centers > Guest Access > Portals & Components > Sponsor Portals > Create, Edit or Duplicate > Portal Behavior and Flow Settings > Acceptable Use Policy (AUP) Page Settings**.

Use these settings to define the AUP experience for the users (guests, sponsors or employees as applicable).

| Field | Usage Guidelines |
|--|---|
| Include an AUP Page | Display your company's network-usage terms and conditions on a separate page to the user. |
| Require scrolling to end of AUP | Ensure that the user has read the AUP completely. The Accept button is enabled only after the user has scrolled to the end of the AUP. |
| On First Login only | Display an AUP when the user logs into the network or portal for the first time only. |
| On Every Login | Display an AUP each time the user logs into the network or portal. |
| Every __ Days (starting at first login) | Display an AUP periodically after the user first logs into the network or portal. |

Sponsor Change Password Settings for Sponsor Portals

To configure the password requirements for sponsors using the Sponsor portal, choose **Work Centers > Guest Access > Portals & Components > Sponsor Portals > Create, Edit or Duplicate > Portal Behavior and Flow Settings > Sponsor Change Password Settings**.

| Field | Usage Guidelines |
|--|--|
| Allow sponsors to change their own passwords | Allow sponsors to change their passwords after they log into the Sponsor portal. This option displays a Change Password page only if the sponsors are part of the Internal Users database. |

Post-Login Banner Settings for Sponsor Portals

The navigation path for this page is **Work Centers > Guest Access > Portals & Components > Guest Portals or Sponsor Portals > Create, Edit or Duplicate > Portal Behavior and Flow Settings > Post-Login Banner Page Settings**.

Use this setting to notify users (guests, sponsors or employees as applicable) of additional information after they log in successfully.

| Field | Usage Guidelines |
|----------------------------------|--|
| Include a Post-Login Banner page | Display additional information after the users successfully log in and before they are granted network access. |

Support Information Page Settings for Sponsor Portals

The navigation path for this page is **Work Centers > Guest Access > Portals & Components > Sponsor Portals > Create, Edit or Duplicate > Portal Behavior and Flow Settings > Support Information Page Settings**.

Use these settings to display the information that your Help Desk can use to troubleshoot access issues experienced by users (guests, sponsors or employees as applicable).

| Field | Usage Guidelines |
|------------------------------------|---|
| Include a Support Information Page | Display a link to an information window, such as Contact Us , on all enabled windows for the portal. |
| MAC Address | Include the MAC address of the device on the Support Information window. |
| IP Address | Include the IP address of the device on the Support Information window. |

| Field | Usage Guidelines |
|---|---|
| Browser User Agent | Include the browser details such as the product name and version, layout engine, and version of the user agent originating the request on the Support Information window. |
| Policy Server | Include the IP address of the ISE Policy Service Node (PSN) that is serving this portal on the Support Information window. |
| Failure Code | If available, include the corresponding number from the log message catalog. To view the message catalog, choose Administration > System > Logging > Message Catalog . |
| Hide Field | Do not display any field labels on the Support Information window if the information that they would contain is non-existent. For example, if the failure code is unknown, and therefore blank, do not display Failure Code , even if it is selected. |
| Display Label with no Value | Display all selected field labels on the Support Information window, even if the information that they would contain is non-existent. For example, if the failure code is unknown, display Failure Code , even if it is blank. |
| Display Label with Default Value | Display this text in any selected field on the Support Information window, if the information that they would contain is non-existent. For example, if you enter Not Available in this field, and the failure code is unknown, the Failure Code field displays Not Available . |

Notify Guests Customization for Sponsor Portals

The navigation path for these settings is **Work Centers > Guest Access > Portals & Components > Sponsor Portals > Create, Edit or Duplicate > Portal Page Customization > Notify Guests**.

Under **Page Customizations**, you can customize the messages, titles, content, instructions, and field and button labels that appear on the notifications that sponsors send to guests from the Sponsor portal.

Under **Settings**, you can specify whether sponsors can send usernames and passwords separately to guests using email or SMS. You can also specify whether sponsors can display a Support Information page for guests to provide information that a help desk can use to troubleshoot access issues.

Manage and Approve Customization for Sponsor Portals

The navigation path for these settings is **Work Centers > Guest Access > Portals & Components > Sponsor Portals > Create, Edit or Duplicate > Portal Page Customization > Manage and Approve**.

Under **Page Customizations**, you can customize the messages, titles, content, instructions, and field and button labels that appear on the Manage and Approve tabs of the Sponsor portal.

These include the accounts (registered and pending) summary and detailed views, the pop-up dialogs that display based on the operations the sponsor performs on guest accounts such as edit, extend, suspend and so on, and also general portal and account action messages.

Global Settings

Global Settings for Guest and Sponsor Portals

Choose **Guest Access > Settings**. You can configure the following general settings that apply to Guest and Sponsor portals, guest types, and sponsor groups in Cisco ISE:

- Policies for purging guest accounts and generating usernames and passwords.
- SMTP servers and SMS gateways to use when sending email and SMS notifications to guests and sponsors.
- Locations, time zones, SSIDs, and custom fields to select from when creating guest accounts and when registering guests using Self-Registration Guest portals.

After configuring these global settings, you can use them as needed when configuring specific Guest and Sponsor portals, guest types, and sponsor groups.

The following tabs are on the Portal settings page:

- **Guest Account Purge Policy:** Schedule when to purge guest accounts that have expired. For more information, see [Schedule When to Purge Expired Guest Accounts, on page 447](#).
- **Custom Fields:** Add custom fields to use in Guest portals, to retrieve additional information from users. For more information, see [Add Custom Fields for Guest Account Creation, on page 447](#).
- **Guest Email Settings:** Decide whether to email notifications to guests about changes in their account. For more information, see [Specify Email Addresses and SMTP Servers for Email Notifications, on page 448](#).
- **Guest Locations and SSIDs:** Configure the Locations and the Service Set Identifiers (SSIDs) of the networks that guests can use at these Locations. For more information, see [Assign Guest Locations and SSIDs, on page 448](#).
- **Guest Username Policy:** Configure how guest user names are created. For more information, see [Set the Guest Username Policy, on page 450](#) and [Rules for Guest Password Policies, on page 449](#).
- **Guest Password Policy:** Define the guest password policies for all Guest and Sponsor portals. For more information, see [Set the Guest Password Policy and Expiration, on page 450](#).

Guest Type Settings

The navigation path for these settings is **Work Centers > Guest Access > Portals & Components > Guest Types**. Use these settings to create the types of Guests that can access your network and their access privileges. You can also specify which Sponsor Groups can create this type of Guest.

- **Guest type name:** Provide a name (from 1 to 256 characters) that distinguishes this Guest Type from the other Guest Types.
- **Description:** Provide additional information (maximum of 2000 characters) about the recommended use of this Guest Type, for example, Use for self-registering Guests.
- **Language File:** This field allows you to export and import the language file, which contains content for email subject, email message, and SMS messages in all supported languages. These languages and content are used in notifications about an expired account, and are sent to guests who are assigned to this guest type. If you are creating a new guest type, this feature is disabled until after you save the guest type. For more information about editing the language file, see [Portal Language Customization, on page 538](#).
- **Collect Additional Data:** Click the **Custom Fields** option to select which custom fields to use to collect additional data from guests using this Guest Type.

To manage custom fields, choose **Work Centers > Guest Access > Settings > Custom Fields**.

- **Maximum Access Time**

- **Account duration starts:** If you select **From first login**, the account start time starts when the guest user first logs in to the guest portal, and the end time equals the configured duration time. If the guest user never logs in, the account remains in the `Awaiting first login` state until the guest account purge policy removes the account.

Values are from 1 to 999 days, hours, or minutes.

A self-registered user's account starts when they create and log on to their account.

If you select **From sponsor-specified date**, enter the maximum number of days, hours, or minutes that Guests of this Guest Type can access and stay connected to the network.

If you change these settings, your changes will not apply to existing Guest accounts that were created using this Guest Type.

- **Maximum account duration:** Enter the number of days, hours, or minutes that guests assigned to this guest type can log on.



Note

The account purge policy checks for expired guest accounts, and sends expiration notification. This policy runs every 20 minutes, so if you set the account duration to less than 20 mins, it is possible that expiration notices may not be sent out before the account is purged.

You can specify the duration time and the days of the week when access is provided to the guests of this Guest Type by using the **Allow access only on these days and times** option.

- The days of the week that you select limits access to the dates that are selectable in the Sponsor's calendar.

- **Maximum account duration** is enforced in the sponsor portal, when the Sponsor picks duration and dates.

The settings you make here for access time affect the time settings that are available on the sponsor portal when creating a guest account. For more information, see [Configuring the Time Settings Available to Sponsors](#) , on page 473.

• **Logon Options**

- **Maximum simultaneous logins**: Enter the maximum number of user sessions that users assigned to this Guest Type can have running concurrently.
- **When guest exceeds limit**: When you select **Maximum simultaneous logins**, you must also select the action to take when a user connects after the maximum number of login is reached.
 - **Disconnect the oldest connection**
 - **Disconnect the newest connection**: If you select **Redirect user to a portal page showing an error message**, an error message is displayed for a configurable amount of time, then the session is disconnected, and the user is redirected to the Guest portal. The error page's content is configured on the Portal Page Customization dialog, on the **Messages > Error Messages** window.
- **Maximum devices guests can register**: Enter the maximum number of devices that can be registered to each Guest. You can set the limit to a number lower than what is already registered for the Guests of this Guest Type. This only affects newly created Guest accounts. When a new device is added, and the maximum is reached, the oldest device is disconnected.
- **Endpoint identity group for guest device registration**: Choose an endpoint identity group to assign to guest devices. Cisco ISE provides the **GuestEndpoints** endpoint identity group to use as a default. You can also create more endpoint identity groups if you choose to not use the default.
- **Allow guest to bypass the Guest portal**: Allows users to bypass the credentialed guest-type captive portal (web authentication page), and access the network by providing credentials to wired and wireless (dot1x) supplicants or VPN clients. Guest accounts change to the *Active* state, bypassing the *Awaiting Initial Login* state and the AUP page, even if the AUP is required.

If you do not enable this setting, users must first log in through the credentialed Guest captive portal before they are able to access other parts of the network.

• **Account Expiration Notification**

- **Send account expiration notification __ days before account expires**: Send a notification to Guests before their account expires and specify how many days, hours, or minutes before the expiration.
- **View messages in**: Specify the language to use when displaying email or SMS notifications as you set them up.
- **Email**: Send account expiration notices by email.
- **Use customization from**: Apply the same customizations that you configured for the selected portal to this Guest Type's account expiration emails.
- **Copy text from**: Reuse email text that you created for another Guest Type's account expiration email.

- **SMS:** Send account expiration notices by SMS.

The settings that follow for SMS are the same as for email notifications, except that you choose an SMS gateway for **Send test SMS to me**.

- **Sponsor Groups:** Specify the sponsor groups whose members can create a guest account using this guest type. Delete the sponsor groups that you do not want to have access to this guest type.

Sponsor Group Settings

The navigation path for these settings is **Work Centers > Guest Access > Portals & Components > Sponsor Groups**. Use these settings to add members to the sponsor group, define guest types and location privileges, and set permissions related to creating and managing guest accounts.

- **Disable Sponsor Group:** Disable members of this sponsor group from accessing the Sponsor portal.
For instance, you may want to temporarily prevent sponsors from logging in to the Sponsor portal while configuration changes are being made in the Admin portal. Or, you may want to disable a sponsor group that is involved in infrequent activity, such as sponsoring guests for an annual convention, until the time they need to be activated again.
- **Sponsor group name:** Enter a unique name (from 1 to 256 characters).
- **Description:** Include useful information (maximum of 2000 characters) such as the guest types used by this sponsor group.
- **Configure Guest Types:** If the guest type you need is not available, click **Work Centers > Guest Access > Portals & Components > Guest Types** and create a new guest type or edit an existing one.
- **Match Criteria**
 - **Members:** Click to display the **Select Sponsor Group Members** box, where you can select available user identity groups (from internal and external identity stores) and add them as members of this sponsor group.
 - **Sponsor Group Members:** Search and filter the list of selected sponsor groups and delete any groups you do not want to include.
 - **Other conditions:** Click **Create New Condition** to build one or more conditions that a sponsor must match to be included in this sponsor group. You can use authentication attributes from Active Directory, LDAP, SAML, and ODBC identity stores, but not RADIUS Token or RSA SecurID stores. You can also use internal user attributes. Conditions have an attribute, and operator, and a value.
 - To create a condition using the internal dictionary attribute *Name*, prefix the identity group name with User Identity Groups. For example:
InternalUser:Name EQUALS bsmith
This means that only internal users with the Name "bsmith" can belong to this sponsor group.
- **This sponsor group can create accounts using these guest types:** Specify the guest types that the members in this sponsor group can use when creating guest accounts. For a sponsor group to be enabled, it must have at least one guest type that it can use.

If you assign only one guest type to this sponsor group, you can choose not to display it in the Sponsor portal because it is the only valid guest type available for use. Choose **Work Centers > Guest Access > Portals & Components > Sponsor Portal > Page Customization > Create Accounts > Guest Types > Settings**. Check **Hide guest type if only one is available to sponsor** to enable this option.

- **Select the locations that guests will be visiting:** Select the locations that can be assigned to guests while creating their accounts. This helps define the valid time zones for these guest accounts and specifies all the time parameters that apply to the guest, such as valid access times. This does not prevent guests from connecting to the network from other locations.

For a sponsor group to be enabled, it must have at least one location that it can use.

If you assign only one location to this sponsor group, it will be the only valid time zone for the guest accounts created by its members. By default, it does not display in the Sponsor portal.

Sponsor Can Create

- **Multiple guest accounts assigned to specific guests (Import):** Enable the sponsor to create multiple guest accounts by importing guest details such as first name and last name from a file.

If this option is enabled, the **Import** option appears in the **Create Accounts** page of the Sponsor portal. The Import option is only available on desktop browsers (not mobile), such as Internet Explorer, Firefox, Safari, and so on.

- **Limit to batch of:** If this sponsor group is allowed to create multiple accounts simultaneously, specify the number of guest accounts that can be created in a single import operation.

Although a sponsor can create a maximum of 10,000 accounts, we recommend that you limit the number of accounts you create, due to potential performance issues.

- **Multiple guest accounts to be assigned to any guests (Random):** Enable the sponsor to create multiple random guest accounts as placeholders for guests who are not known as yet, or when they need to create many accounts quickly.

If this option is enabled, the **Random** option appears in the **Create Accounts** window of the Sponsor portal.

- **Default username prefix:** Specify a username prefix that sponsors can use when creating multiple random guest accounts. If specified, this prefix appears in the Sponsor Portal when creating random guest accounts. In addition, if **Allow sponsor to specify a username prefix** is:

- Enabled: The sponsor can edit the default prefix in the Sponsor portal.
- Not enabled: The sponsor cannot edit the default prefix in the Sponsor portal.

If you do not specify a username prefix or allow the sponsor to specify one, then the sponsor will not be able to assign username prefixes in the Sponsor portal.

- **Allow sponsor to specify a username prefix:** If this sponsor group is allowed to create multiple accounts simultaneously, specify the number of guest accounts that can be created in a single import operation.

Although a sponsor can create a maximum of 10,000 accounts, we recommend that you limit the number of accounts you create, due to potential performance issues.

- **Start date can be no more than __ days into the future:** Specify the number of days within which sponsors have to set as the start date for the multiple guest accounts they have created.

Sponsor Can Manage

- **Only accounts sponsor has created:** Sponsors in this group can view and manage only the guest accounts that they have created, which is based on the Sponsor's email account.
- **Accounts created by members of this sponsor group:** Sponsors in this group can view and manage the guest accounts created by any sponsor in this sponsor group.
- **All guest accounts:** Sponsors view and manage all pending guest accounts.



Note Regardless of the group membership, all sponsors can see all pending accounts, unless you check **Approve and view requests from self-registering guests** with the option **Only pending accounts assigned to this sponsor** under **Sponsor Can**.

Sponsor Can

- **Update guests' contact information (email, Phone Number):** For guest accounts that they can manage, allow the sponsor to change a guest's contact information
- **View/print guests' passwords:** When this option is enabled, the sponsor can print passwords for guests. The sponsor can see the passwords for guests on the **Manage Accounts** window and in the details for a guest. When this is not checked, the sponsor can't print the password, but the user can still get the password through email or SMS, if configured.
- **Send SMS notifications with guests' credentials:** For guest accounts that they can manage, allow the sponsor to send SMS (text) notifications to guests with their account details and login credentials.
- **Reset guest account passwords:** For guest accounts that they can manage, allow the sponsor to reset passwords for guests to a random password generated by Cisco ISE.
- **Extend guests' accounts:** For guest accounts that they can manage, allow the sponsor to extend them beyond their expiration date. The sponsor is automatically copied on email notifications sent to guests regarding their account expiration.
- **Delete guests' accounts:** For guest accounts that they can manage, allow the sponsor to delete the accounts, and prevent guests from accessing your company's network.
- **Suspend guests' accounts:** For guest accounts that they can manage, allow the sponsor to suspend their accounts to prevent guests from logging in temporarily.

This action also issues a Change of Authorization (CoA) Terminate to remove the suspended guests from the network.

- **Require sponsor to provide a reason:** Require the sponsor to provide an explanation for suspending the guest accounts.
- **Approve and view requests from self-registering guests:** Sponsors who are included in this Sponsor Group can either view all pending account requests from self-registering guests (that require approval), or only the requests where the user entered the Sponsor's email address as the person being visited. This feature requires that the portal used by the Self-registering guest has **Require self-registered guests to be approved** checked, and the Sponsor's email is listed as the person to contact.
 - Any pending accounts: A sponsor belonging to this group can approve and review accounts that were created by any sponsor.

- Only pending accounts assigned to this sponsor: A sponsor belonging to this group can only view and approve accounts that they created.
- **Access Cisco ISE guest accounts using the programmatic interface (Guest REST API):** For guest accounts that they can manage, allow the sponsor to access guest accounts using the Guest REST API programming interface.



CHAPTER 30

Administration User Interface Reference

- [Deployment and Node Settings, on page 953](#)
- [Trusted Certificate Settings, on page 962](#)
- [Certificate Store Settings, on page 965](#)
- [Logging Settings, on page 980](#)
- [Maintenance Settings, on page 983](#)
- [Admin Access Settings, on page 986](#)
- [General TrustSec Settings, on page 990](#)
- [Settings, on page 992](#)
- [Identity Management, on page 1008](#)
- [Network Resources, on page 1022](#)
- [Device Portal Management, on page 1047](#)

Deployment and Node Settings

The **Deployment Nodes** window enables you to configure the Cisco ISE (PAN, PSN, and MnT) nodes and to set up a deployment.

Deployment Nodes List Window

Table 72: Deployment Nodes List

| Field Name | Usage Guidelines |
|------------|--|
| Hostname | Displays the hostname of the node. |
| Node Type | Displays the node type.
It can be one of the following: <ul style="list-style-type: none">• Cisco ISE (PAN, PSN, Mnt) nodes |

| Field Name | Usage Guidelines |
|--------------------|--|
| Personas | <p>(Only appears if the node type is Cisco ISE) Lists the personas that a Cisco ISE node has assumed, for example, Administration, Policy Service, Monitoring, or pxGrid.</p> <p>For example, Administration, Policy Service, Monitoring, or pxGrid.</p> |
| Role | <p>Indicates the role (primary, secondary, or standalone) that the Administration and Monitoring personas have assumed, if these personas are enabled on this node. The role can be any one or more of the following:</p> <ul style="list-style-type: none"> • PRI(A): Refers to the primary PAN • SEC(A): Refers to the secondary PAN • PRI(M): Refers to the primary MnT • SEC(M): Refers to the secondary MnT |
| Services | <p>(Only appears if the Policy Service persona is enabled) Lists the services that run on this Cisco ISE node. Services can include any one of the following:</p> <ul style="list-style-type: none"> • Identity Mapping • Session • Profiling • All |
| Node Status | <p>Indicates the status of each Cisco ISE node in a deployment for data replication:</p> <ul style="list-style-type: none"> • Green (Connected): Indicates that a Cisco ISE node, which is already registered in the deployment, is in sync with the primary PAN. • Red (Disconnected): Indicates that a Cisco ISE node is not reachable, is down, or data replication is not happening. • Orange (In Progress): Indicates that a Cisco ISE node is newly registered with the primary PAN, you have performed a manual sync operation, or the Cisco ISE node is not in sync (out of sync) with the primary PAN. <p>For more information, click the quick view icon for each Cisco ISE node in the Node Status column.</p> |

Related Topics

- [Cisco ISE Distributed Deployment](#), on page 46
- [Cisco ISE Deployment Terminology](#), on page 45
- [Configure a Cisco ISE Node](#), on page 49
- [Register a Secondary Cisco ISE Node](#)

General Node Settings

The following table describes the fields on the **General Settings** window of a Cisco ISE node. In this window, you can assign a persona to a node and configure the services to be run on it. The navigation path for this window is: **Administration > System > Deployment > Deployment Node > Edit > General Settings**.

Table 73: General Node Settings

| Field Name | Usage Guidelines |
|-----------------------|--|
| Hostname | Displays the hostname of the Cisco ISE node. |
| FQDN | Displays the fully qualified domain name of the Cisco ISE node, for example, ise1.cisco.com. |
| IP Address | Displays the IP address of the Cisco ISE node. |
| Node Type | Displays the node type. |
| Personas | |
| Administration | <p>Check this check box if you want a Cisco ISE node to assume the Administration persona. You can enable the Administration persona only on nodes that are licensed to provide the administrative services.</p> <p>Role: Displays the role that the Administration persona has assumed in the deployment. The persona can take any one of the following values: Standalone, Primary, or Secondary.</p> <p>Make Primary: Click this button to make this node your primary Cisco ISE node. You can have only one primary Cisco ISE node in a deployment. The other options in this window will become active only after you make this node primary. You can have only two Administration nodes in a deployment. If the node has a Standalone role, the Make Primary button appears next to it. If the node has a Secondary role, the Promote to Primary button appears next to it. If the node has a Primary role and there are no other nodes registered with it, the Make Standalone button appears next to it. You can click the Make Standalone button to make your primary node a standalone node.</p> |

| Field Name | Usage Guidelines |
|-------------------|--|
| Monitoring | <p>Check this check box if you want a Cisco ISE node to assume the Monitoring persona and function as your log collector. There must be at least one Monitoring node in a distributed deployment. At the time of configuring your primary PAN, you must enable the Monitoring persona. After you register a secondary Monitoring node in your deployment, you can edit the primary PAN and disable the Monitoring persona, if required.</p> <p>To configure a Cisco ISE node on a VMware platform as your log collector, use the following guidelines to determine the minimum amount of disk space that you need: 180 KB per endpoint in your network, per day 2.5 MB per Cisco ISE node in your network, per day.</p> <p>You can calculate the maximum disk space that you need based on how many months of data you want to have in your Monitoring node. If there is only one Monitoring node in your deployment, it assumes the standalone role. If you have two Monitoring nodes in your deployment, Cisco ISE displays the name of the other Monitoring node for you to configure the primary-secondary roles. To configure these roles, choose one of the following:</p> <ul style="list-style-type: none"> • Primary: For the current node to be the primary Monitoring node. • Secondary: For the current node to be the secondary Monitoring node. • None: If you do not want the Monitoring nodes to assume the primary-secondary roles. <p>If you configure one of your Monitoring nodes as primary or secondary, the other Monitoring node automatically becomes the secondary or primary node, respectively. Both the primary and secondary Monitoring nodes receive Administration and Policy Service logs. If you change the role for one Monitoring node to None, the role of the other Monitoring node also becomes None, thereby cancelling the high availability pair after you designate a node as a Monitoring node. You will find this node listed as a syslog target in the Remote Logging Targets window: Administration > System > Logging > Remote Logging Targets.</p> |

| Field Name | Usage Guidelines |
|----------------|------------------|
| Policy Service | |

| Field Name | Usage Guidelines |
|------------|--|
| | <p>Check this check box to enable any one or all of the following services:</p> <ul style="list-style-type: none"> Enable Session Services: Check this check box to enable network access, posture, guest, and client-provisioning services. Choose the group to which this Policy Service node belongs from the Include Node in Node Group drop-down list. Note that Certificate Authority (CA) and Enrollment over Secure Transport (EST) services can only run on a Policy Service node that has session services enabled on it. <p>For Include Node in Node Group, choose None if you do not want this Policy Service node to be a part of any group.</p> <p>All the nodes within the same node group should be configured on the network access device (NAD) as RADIUS clients and authorized for CoA, because any one of them can issue a CoA request for the sessions that are established through any node in the node group. If you are not using a load balancer, the nodes in a node group should be the same as, or a subset of the RADIUS servers and clients configured on the NAD. These nodes would also be configured as RADIUS servers.</p> <p>While a single NAD can be configured with many Cisco ISE nodes as RADIUS servers and dynamic-authorization clients, it is not necessary for all the nodes to be in the same node group.</p> <p>The members of a node group should be connected to each other using high-speed LAN connection such as Gigabit Ethernet. The node group members need not be L2 adjacent, but L2 adjacency is highly recommended to ensure sufficient bandwidth and reachability. See the Create a Policy Service Node Group, on page 70 section for more details.</p> <ul style="list-style-type: none"> Enable Profiling Service: Check this check box to enable the Profiling service. If you enable the Profiling service, you must click the Profiling Configuration tab and enter the details as required. When you enable or disable any of the services that run on the Policy Service node or make any changes to this node, you will be restarting the application server processes on which these services run. Expect a delay while these services restart. You can determine when |

| Field Name | Usage Guidelines |
|---------------|--|
| | <p>the application server has restarted on a node by using the show application status ise command from the CLI.</p> <ul style="list-style-type: none"> • Enable Threat-Centric NAC Service: Check this check box to enable the Threat-Centric Network Access Control (TC-NAC) feature. This feature allows you to create authorization policies based on the threat and vulnerability attributes received from the threat and vulnerability adapters. Threat severity levels and vulnerability assessment results can be used to dynamically control the access level of an endpoint or a user. • Enable SXP Service: Check this check box to enable SXP service on the node. You must also specify the interface to be used for SXP service. If you have configured NIC bonding or teaming, the bonded interfaces are also listed along with the physical interfaces in the Use Interface drop-down list. • Enable Device Admin Service: Check this check box to create TACACS policy sets, policy results, and so on, to control and audit the configuration of network devices. • Enable Passive Identity Service: Check this check box to enable the Identity Mapping feature. This feature enables you to monitor users who are authenticated by a Domain Controller and not by Cisco ISE. In networks where Cisco ISE does not actively authenticate users for network access, you can use the Identity Mapping feature to collect user authentication information from the Active Directory Domain Controller. |
| pxGrid | <p>Check this check box to enable the pxGrid persona. Cisco pxGrid is used to share the context-sensitive information from the Cisco ISE session directory to other policy network systems such as Cisco Adaptive Security Appliance (ASA). The pxGrid framework can also be used to exchange policy and configuration data between nodes, for example, sharing tags and policy objects between Cisco ISE and third-party vendors, and for non-Cisco ISE-related information exchanges such as threat information.</p> |

Related Topics

[Personas in Distributed Cisco ISE Deployments](#), on page 46

- [Administration Node](#), on page 53
- [Policy Service Node](#), on page 60
- [Monitoring Node](#), on page 61
- [Cisco pxGrid Node](#), on page 63
- [Synchronize Primary and Secondary Cisco ISE Nodes](#), on page 69
- [Create a Policy Service Node Group](#), on page 70
- [Deploy Cisco pxGrid Node](#), on page 66
- [Change Node Personas and Services](#), on page 69
- [Configure MnT Nodes for Automatic Failover](#), on page 71

Profiling Node Settings

The following table describes the fields in the **Profiling Configuration** window, that you can use to configure the probes for the profiler service. The navigation path for this window is: **Administration > System > Deployment > ISE Node > Edit > Profiling Configuration**.

Table 74: Profiling Node Settings

| Field Name | Usage Guidelines |
|------------------|---|
| NetFlow | <p>Check this check box to enable NetFlow for each Cisco ISE node that has assumed the Policy Service persona to receive NetFlow packets sent from the routers. Enter the required values for the following options:</p> <ul style="list-style-type: none"> • Interface: Choose the interface on the Cisco ISE node. • Port: Enter the NetFlow listener port number on which NetFlow exports are received from the routers. The default port is 9996. |
| DHCP | <p>Check this check box to enable DHCP for each Cisco ISE node that has assumed the Policy Service persona to listen for DHCP packets from the IP helper. Enter the required values for the following options:</p> <ul style="list-style-type: none"> • Interface: Choose the interface on the Cisco ISE node. • Port: Enter the DHCP server UDP port number. The default port is 67. |
| DHCP SPAN | <p>Check this check box to enable DHCP SPAN for each Cisco ISE node that has assumed the Policy Service persona to collect DHCP packets.</p> <ul style="list-style-type: none"> • Interface: Choose the interface on the Cisco ISE node. |

| Field Name | Usage Guidelines |
|----------------------------|--|
| HTTP | <p>Check this check box to enable HTTP per Cisco ISE node that has assumed the Policy Service persona to receive and parse HTTP packets.</p> <ul style="list-style-type: none"> • Interface: Choose the interface on the Cisco ISE node. |
| RADIUS | <p>Check this check box to enable RADIUS for each Cisco ISE node that has assumed the Policy Service persona to collect RADIUS session attributes as well as Cisco Device Protocol (CDP) and Link Layer Discovery Protocol (LLDP) attributes from the Cisco IOS Sensor-enabled devices.</p> |
| Network Scan (NMAP) | <p>Check this check box to enable the NMAP probe.</p> |
| DNS | <p>Check this check box to enable DNS for each Cisco ISE node that has assumed the Policy Service persona to perform a DNS lookup for the FQDN. Enter the Timeout period in seconds.</p> <p>Note For the DNS probe to work on a particular Cisco ISE node in a distributed deployment, you must enable one of the following probes: DHCP, DHCP SPAN, HTTP, RADIUS, or SNMP. For DNS lookup, one of these probes must be started along with the DNS probe.</p> |
| SNMP Query | <p>Check this check box to enable SNMP query for each Cisco ISE node that has assumed the Policy Service persona to poll network devices at specified intervals. Enter values in Retries, Timeout, Event Timeout(mandatory), and Description(optional).</p> <p>Note In addition to configuring the SNMP Query probe, you must also configure other SNMP settings in the following location: Administration > Network Resources > Network Devices. When you configure SNMP settings on the network devices, ensure that you enable CDP and LLDP globally on your network devices.</p> |

| Field Name | Usage Guidelines |
|------------------|---|
| SNMP Trap | <p>Check this check box to enable an SNMP Trap probe for each Cisco ISE node that has assumed the Policy Service Persona to receive linkUp, linkDown, and MAC notification traps from the network devices. Provide or enable the following information:</p> <ul style="list-style-type: none"> • Link Trap Query: Check this check box to receive and interpret notifications received through the SNMP trap. • MAC Trap Query: Check this check box to receive and interpret MAC notifications received through the SNMP trap. • Interface: Choose an interface on the Cisco ISE node. • Port: Enter the UDP port of the host to use. The default port is 162. |
| Active Directory | <p>Check this check box to scan the defined Active Directory servers for information about Windows users.</p> <ul style="list-style-type: none"> • Days before rescan: Choose the days after which you want the scan to run again. |
| pxGrid | <p>Check this check box to allow Cisco ISE to collect (profile) endpoint attributes over pxGrid.</p> |

Related Topics

[Cisco ISE Profiling Service](#), on page 633

[Network Probes Used by Profiling Service](#), on page 636

[Configure Profiling Service in Cisco ISE Nodes](#), on page 636

Trusted Certificate Settings

The following table describes the fields in the **Edit** window of a Trusted Certificate. Edit the CA certificate attributes in this window. The navigation path for this page is **Administration > System > Certificates > Trusted Certificates**. Check the check box for the Trusted Certificate you want to edit, and click **Edit**.

Table 75: Trusted Certificate Edit Settings

| Field Name | Usage Guidelines |
|--------------------|------------------|
| Certificate Issuer | |

| Field Name | Usage Guidelines |
|---|--|
| Friendly Name | Enter a friendly name for the certificate. This is an optional field. If you do not enter a friendly name, a default name is generated in the following format:

<i>common-name#issuer#nnnnn</i> |
| Status | Choose Enabled or Disabled from the drop-down list. If the certificate is disabled, Cisco ISE will not use the certificate for establishing trust. |
| Description | (Optional) Enter a description. |
| Usage | |
| Trust for authentication within ISE | Check this check box if you want this certificate to verify server certificates (from other Cisco ISE nodes or LDAP servers). |
| Trust for client authentication and Syslog | (Applicable only if you check the Trust for authentication within ISE check box) Check the check box if you want this certificate to be used to: <ul style="list-style-type: none"> • Authenticate endpoints that connect to Cisco ISE using the EAP protocol. • Trust a Syslog server. |
| Trust for authentication of Cisco Services | Check this check box if you want this certificate to be used to trust external Cisco services such as the Feed Service. |
| Certificate Status Validation | Cisco ISE supports two ways of checking the revocation status of a client or server certificate that is issued by a particular CA. The first way is to validate the certificate using the Online Certificate Status Protocol (OCSP), which makes a request to an OCSP service maintained by the CA. The second way is to validate the certificate against a CRL which is downloaded from the CA into Cisco ISE. Both of these methods can be enabled, in which case OCSP is used first and only if a status determination cannot be made then the CRL is used. |
| Validate Against OCSP Service | Check the check box to validate the certificate against OCSP services. You must first create an OCSP Service to be able to check this box. |

| Field Name | Usage Guidelines |
|--|---|
| Reject the request if OCSP returns UNKNOWN status | Check the check box to reject the request if certificate status is not determined by the OCSP service. If you check this check box, an unknown status value that is returned by the OCSP service causes Cisco ISE to reject the client or server certificate currently being evaluated. |
| Reject the request if OCSP Responder is unreachable | Check the check box for Cisco ISE to reject the request if the OCSP Responder is not reachable. |
| Download CRL | Check the check box for the Cisco ISE to download a CRL. |
| CRL Distribution URL | Enter the URL to download the CRL from a CA. This field is automatically populated if it is specified in the certificate authority certificate. The URL must begin with “http”, “https”, or “ldap.” |
| Retrieve CRL | The CRL can be downloaded automatically or periodically. Configure the time interval between downloads. |
| If download failed, wait | Configure the time interval that Cisco ISE must wait Cisco ISE tries to download the CRL again. |
| Bypass CRL Verification if CRL is not Received | Check this check box, for the client requests to be accepted before the CRL is received. If you uncheck this check box, all client requests that use certificates signed by the selected CA will be rejected until Cisco ISE receives the CRL file. |
| Ignore that CRL is not yet valid or expired | <p>Check this check box if you want Cisco ISE to ignore the start date and expiration date and continue to use the not yet active or expired CRL and permit or reject the EAP-TLS authentications based on the contents of the CRL.</p> <p>Uncheck this check box if you want Cisco ISE to check the CRL file for the start date in the Effective Date field and the expiration date in the Next Update field. If the CRL is not yet active or has expired, all authentications that use certificates signed by this CA are rejected.</p> |

Related Topics

[Trusted Certificates Store](#), on page 151

[Edit a Trusted Certificate](#), on page 154

Certificate Store Settings

The Certificate Store window enables you to configure certificates in Cisco ISE that can be used for authentication.

Self-Signed Certificate Settings

Table 76: Self-Signed Certificate Settings

| Field Name | Usage Guidelines |
|---------------------------------------|--|
| Select Node | (Required) Choose the node for which you want to generate the system certificate from the drop-down list. |
| Common Name (CN) | (Required if you do not specify a SAN) By default, the common name is the FQDN of the Cisco ISE node for which you are generating the self-signed certificate. |
| Organizational Unit (OU) | Organizational Unit name. For example, Engineering. |
| Organization (O) | Organization name. For example, Cisco. |
| City (L) | (Do not abbreviate) City name. For example, San Jose. |
| State (ST) | (Do not abbreviate) State name. For example, California. |
| Country (C) | Country name. Enter the two-letter ISO country code. For example, US. |
| Subject Alternative Name (SAN) | An IP address, DNS name, or Uniform Resource Identifier (URI) that is associated with the certificate. |
| Key Length | <p>The bit size for the public key. Choose one of the following options from the drop-down list for RSA:</p> <ul style="list-style-type: none"> • 512 • 1024 • 2048 • 4096 <p>Choose one of the following options from the drop-down list for ECDSA:</p> <ul style="list-style-type: none"> • 256 • 384 <p>Choose 2048 if you plan to get a public CA-signed certificate or deploy Cisco ISE as a FIPS-compliant policy management system.</p> |

| Field Name | Usage Guidelines |
|------------------------------------|---|
| Digest to Sign With | Choose one of the following hashing algorithms from the drop-down list: <ul style="list-style-type: none"> • SHA-1 • SHA-256 |
| Certificate Policies | Enter the certificate policy OID or list of OIDs that the certificate should conform to. Use a comma or space to separate the OIDs. |
| Expiration TTL | Specify the number of days after which the certificate expires. Choose the value from the drop-down lists. |
| Friendly Name | Enter a friendly name for the certificate. If you do not specify a name, Cisco ISE automatically creates a name in the format <common name> # <issuer> # <nnnnn> where <nnnnn> is a unique five-digit number. |
| Allow Wildcard Certificates | Check this check box if you want to generate a self-signed wildcard certificate. A wildcard certificate uses a wildcard notation (an asterisk and period before the domain name) and allows the certificate to be shared across multiple hosts in an organization. |
| Usage | Choose the service for which this system certificate must be used: <ul style="list-style-type: none"> • Admin: Server certificate used to secure communication with the administration portal and between the Cisco ISE nodes in a deployment. • EAP Authentication: Server certificate used for authentications that use the EAP protocol for SSL or TLS tunneling. • RADIUS DTLS: Server certificate used for RADIUS DTLS authentication. • pxGrid: Client and server certificate to secure communication between the pxGrid client and the server. • SAML: Server certificate used to secure communication with the SAML identity provider. A certificate that is designated for SAML use cannot be used for any other service such as Admin, EAP authentication, and so on. • Portal: Server certificate used to secure communication with all Cisco ISE web portals. |

Related Topics

[System Certificates](#), on page 146

[View System Certificates](#), on page 147

[Generate a Self-Signed Certificate](#), on page 148

Certificate-Signing Request Settings

Cisco ISE allows you to generate certificate-signing requests for all the nodes in your deployment from the Admin portal in a single request. Also, you can choose to generate the certificate signing request for a single node or multiple both nodes in the deployment. If you choose to generate a certificate signing request for a single node, ISE automatically substitutes the Fully Qualified Domain Name (FQDN) of the particular node in the CN= field of the certificate subject. If you choose to include an entry in the Subject Alternative Name

(SAN) field of the certificate, you must enter the FQDN of the ISE node in addition to other SAN attributes. If you choose to generate certificate signing requests for all the nodes in your deployment, check the Allow Wildcard Certificates check box and enter the wildcard FQDN notation in the SAN field (DNS name), for example, *.amer.example.com. If you plan to use the certificate for EAP Authentication, do not enter the wildcard value in the CN= field.

With the use of wildcard certificates, you no longer have to generate a unique certificate for each Cisco ISE node. Also, you no longer have to populate the SAN field with multiple FQDN values to prevent certificate warnings. Using an asterisk (*) in the SAN field allows you to share a single certificate across multiple both nodes in a deployment and helps prevent certificate name mismatch warnings. However, use of wildcard certificates is considered less secure than assigning a unique server certificate for each Cisco ISE node.

Table 77: Certificate-Signing Request Settings

| Field | Usage Guidelines |
|---------------------------------|------------------|
| Certificate(s) will be used for | |

| Field | Usage Guidelines |
|-------|--|
| | <p>Choose the service for which you are going to use the certificate:</p> <p>Cisco ISE Identity Certificates</p> <ul style="list-style-type: none"> • Multi-Use: Used for multiple services (Admin, EAP-TLS Authentication, pxGrid, and Portal). Multi-use certificates use both client and server key usages. The certificate template on the signing CA is often called a Computer or Machine certificate template. This template has the following properties: <ul style="list-style-type: none"> • Key Usage: Digital Signature (Signing) • Extended Key Usage: TLS Web Server Authentication (1.3.6.1.5.5.7.3.1) and TLS Web Client Authentication (1.3.6.1.5.5.7.3.2) • Admin: Used for server authentication (to secure communication with the Admin portal and between ISE nodes in a deployment). The certificate template on the signing CA is often called a Web Server certificate template. This template has the following properties: <ul style="list-style-type: none"> • Key Usage: Digital Signature (Signing) • Extended Key Usage: TLS Web Server Authentication (1.3.6.1.5.5.7.3.1) • EAP Authentication: Used for server authentication. The certificate template on the signing CA is often called a Computer or Machine certificate template. This template has the following properties: <ul style="list-style-type: none"> • Key Usage: Digital Signature (Signing) • Extended Key Usage: TLS Web Server Authentication (1.3.6.1.5.5.7.3.1) <p>Note Digital signature key usage is required for EAP-TLS client certificates.</p> <ul style="list-style-type: none"> • RADIUS DTLS: Used for RADIUS DTLS server authentication. This template has the following properties: <ul style="list-style-type: none"> • Key Usage: Digital Signature (Signing) • Extended Key Usage: TLS Web Server Authentication (1.3.6.1.5.5.7.3.1) • Portal: Used for server authentication (to secure communication with all ISE web portals). The certificate template on the signing CA is often called a Computer or Machine certificate template. This template has the following properties: <ul style="list-style-type: none"> • Key Usage: Digital Signature (Signing) • Extended Key Usage: TLS Web Server Authentication (1.3.6.1.5.5.7.3.1) • pxGrid: Used for both client and server authentication (to secure communication between the pxGrid client and server). The certificate template on the signing CA is often called a Computer or Machine certificate template. This template has the following properties: <ul style="list-style-type: none"> • Key Usage: Digital Signature (Signing) |

| Field | Usage Guidelines |
|------------------------------------|---|
| | <ul style="list-style-type: none"> • Extended Key Usage: TLS Web Server Authentication (1.3.6.1.5.5.7.3.1) and TLS Web Client Authentication (1.3.6.1.5.5.7.3.2) • SAML: Server certificate used to secure communication with the SAML Identity Provider (IdP). A certificate designated for SAML use cannot be used for any other service such as Admin, EAP authentication, and so on. • Key Usage: Digital Signature (Signing) • Extended Key Usage: TLS Web Server Authentication (1.3.6.1.5.5.7.3.1) <p>Note We recommend that you do not use a certificate that contains the value of 2.5.29.37.0 for the Any Purpose object identifier in the Extended Key Usage attribute. If you use a certificate that contains the value of 2.5.29.37.0 for the Any Purpose object identifier in the Extended Key Usage attribute, the certificate is considered invalid and the following error message is displayed:</p> <pre>source=local ; type=fatal ; message="unsupported certificate"</pre> <p>Cisco ISE Certificate Authority Certificates</p> <ul style="list-style-type: none"> • ISE Root CA: (Applicable only for the internal CA service) Used for regenerating the entire internal CA certificate chain including the root CA on the Primary PAN and subordinate CAs on the PSNs. • ISE Intermediate CA: (Applicable only for the internal CA service when ISE acts as an intermediate CA of an external PKI) Used to generate an intermediate CA certificate on the Primary PAN and subordinate CA certificates on the PSNs. The certificate template on the signing CA is often called a Subordinate Certificate Authority. This template has the following properties: <ul style="list-style-type: none"> • Basic Constraints: Critical, Is a Certificate Authority • Key Usage: Certificate Signing, Digital Signature • Extended Key Usage: OCSP Signing (1.3.6.1.5.5.7.3.9) • Renew ISE OCSP Responder Certificates: (Applicable only for the internal CA service) Used to renew the ISE OCSP responder certificate for the entire deployment (and is not a certificate signing request). For security reasons, we recommend that you renew the ISE OCSP responder certificates every six months. |
| Allow Wildcard Certificates | Check this check box to use a wildcard character (*) in the CN and/or the DNS name in the SAN field of the certificate. If you check this check box, all the nodes in the deployment are selected automatically. You must use the asterisk (*) wildcard character in the left-most label position. If you use wildcard certificates, we recommend that you partition your domain space for greater security. For example, instead of *.example.com, you can partition it as *.amer.example.com. If you do not partition your domain, it might lead to security issues. |

| Field | Usage Guidelines |
|---------------------------------------|--|
| Generate CSRs for these Nodes | Check the check boxes next to the nodes for which you want to generate the certificate. To generate a CSR for select nodes in the deployment, you must uncheck the Allow Wildcard Certificates option. |
| Common Name (CN) | By default, the common name is the FQDN of the ISE node for which you are generating the certificate signing request. \$FQDN\$ denotes the FQDN of the ISE node. When you generate certificate signing requests for multiple nodes in the deployment, the Common Name field in the certificate signing requests is replaced with the FQDN of the respective ISE nodes. |
| Organizational Unit (OU) | Organizational Unit name. For example, Engineering. |
| Organization (O) | Organization name. For example, Cisco. |
| City (L) | (Do not abbreviate) City name. For example, San Jose. |
| State (ST) | (Do not abbreviate) State name. For example, California. |
| Country (C) | Country name. You must enter the two-letter ISO country code. For example, US. |
| Subject Alternative Name (SAN) | <p>An IP address, DNS name, Uniform Resource Identifier (URI), or Directory Name that is associated with the certificate.</p> <ul style="list-style-type: none"> • DNS Name: If you choose the DNS name, enter the fully qualified domain name of the ISE node. If you have enabled the Allow Wildcard Certificates option, specify the wildcard notation (an asterisk and a period before the domain name). For example, *.amer.example.com. • IP Address: IP address of the ISE node to be associated with the certificate. • Uniform Resource Identifier: A URI that you want to associate with the certificate. • Directory Name: A string representation of distinguished name(s) (DNs) defined per RFC 2253. Use a comma (,) to separate the DN's. For "dnQualifier" RDN, escape the comma and use backslash-comma "\", as separator. For example, CN=AAA,dnQualifier=O=Example\,DC=COM,C=IL |
| Key Length | Choose 2048 or greater if you plan to get a public CA-signed certificate or deploy Cisco ISE as a FIPS-compliant policy management system. |
| Digest to Sign With | Choose one of the following hashing algorithm: SHA-1 or SHA-256. |
| Certificate Policies | Enter the certificate policy OID or list of OIDs that the certificate should conform to. Use comma or space to separate the OIDs. |

Related Topics

[Certificate-Signing Requests](#), on page 158

[Create a Certificate-Signing Request and Submit it to a Certificate Authority](#), on page 158

[Bind a CA-Signed Certificate to a Certificate Signing Request](#), on page 158

Issued and Revoked Certificates

Table 78: Issued and Revoked Certificates

| Fields | Usage Guidelines |
|------------------------------|--|
| Node Name | Name of the Policy Service node (PSN) that issued the certificate. |
| Certificates Issued | Number of endpoint certificates issued by the PSN node. |
| Certificates Revoked | Number of revoked endpoint certificates (certificates that were issued by the PSN node). |
| Certificates Requests | Number of certificate-based authentication requests processed by the PSN node. |
| Certificates Failed | Number of failed authentication requests processed by the PSN node. |

Related Topics

[Issued Certificates](#), on page 172

[User and Endpoint Certificate Renewal](#), on page 162

[Configure Cisco ISE to Use Certificates for Authenticating Personal Devices](#), on page 176

[Configure Cisco ISE to Allow Users to a Renew Certificate](#), on page 162

[Revoke an Endpoint Certificate](#), on page 191

Certificate Periodic Check Settings

Cisco ISE checks the Certificate Revocation Lists (CRL) periodically. Using this window, you can configure Cisco ISE to check ongoing sessions against CRLs that are downloaded automatically. You can specify the time of the day when the OCSP or CRL checks should begin each day and the time interval in hours that Cisco ISE waits before checking the OCSP server or CRLs again.

Table 79: Certificate Periodic Check Settings

| Field Name | Usage Guidelines |
|---|--|
| Certificate Check Settings | |
| Check ongoing sessions against automatically retrieved CRL | Check this check box if you want Cisco ISE to check ongoing sessions against CRLs that are automatically downloaded. |
| CRL/OCSP Periodic Certificate Checks | |
| First check at | Specify the time of the day when the CRL or OCSP check should begin each day. Enter a value between 00:00 and 23:59 hours. |
| Check every | Specify the time interval in hours that Cisco ISE waits before checking the CRL or OCSP server again. |

Related Topics

[OCSP Services](#), on page 192

[Add OCSP Client Profiles](#), on page 194

System Certificate Import Settings

Table 80: System Certificate Import Settings

| Field Name | Description |
|--|---|
| Select Node | (Required) Choose the Cisco ISE node on which you want to import the system certificate from the drop-down list. |
| Certificate File | (Required) Click Browse and choose the certificate file from your local system. |
| Private Key File | (Required) Click Browse and choose the private key file from your local system. |
| Password | (Required) Enter the password to decrypt the private key file. |
| Friendly Name | Enter a friendly name for the certificate. If you do not specify a name, Cisco ISE automatically creates a name in the following format:

<common name> # <issuer> # <nnnnn> where <nnnnn> is a unique five-digit number. |
| Allow Wildcard Certificates | Check this check box if you want to import a wildcard certificate. A wildcard certificate uses a wildcard notation (an asterisk and period before the domain name). Wildcard certificates are shared across multiple hosts in an organization.

If you check this check box, Cisco ISE imports this certificate to all the other nodes in the deployment. |
| Validate Certificate Extensions | Check this check box if you want Cisco ISE to validate the certificate extensions. If you check this check box and the certificate that you import contains a basic constraints extension with the CA flag set to true, ensure that the key usage extension is present. The keyEncipherment bit or the keyAgreement bit, or both, must also be set. |

| Field Name | Description |
|------------|---|
| Usage | <p>Choose the service for which this system certificate must be used:</p> <ul style="list-style-type: none"> • Admin: Server certificate used to secure communication with the administration portal and between the Cisco ISE nodes in a deployment. <p>Note Changing the certificate of the admin role certificate on the primary PAN restarts services on all other Cisco ISE nodes.</p> <ul style="list-style-type: none"> • EAP Authentication: Server certificate used for authentications that use the EAP protocol for SSL or TLS tunneling. • RADIUS DTLS: Server certificate used for RADIUS DTLS authentication. • pxGrid: Client and server certificate to secure communication between the pxGrid client and the server. • : Used by Syslog Over Cisco ISE Messaging feature, which enables MnT WAN survivability for built-in UDP syslog collection targets (LogCollector and LogCollector2). • SAML: Server certificate used to secure communication with the SAML identity provider. A certificate that is designated for SAML use cannot be used for any other service such as Admin, EAP authentication, and so on. • Portal: Server certificate used to secure communication with all Cisco ISE web portals |

Related Topics

[System Certificates](#), on page 146

[View System Certificates](#), on page 147

[Import a System Certificate](#), on page 148

List of Trusted Certificates

Table 81: Trusted Certificates Window Columns

| Field Name | Usage Guidelines |
|---------------|---|
| Friendly Name | Displays the name of the certificate. |
| Status | This column displays Enabled or Disabled . If the certificate is disabled, Cisco ISE will not use the certificate for establishing trust. |
| Trusted for | <p>Displays one or more of the following services for which the certificate is used.</p> <ul style="list-style-type: none"> • Infrastructure • Cisco Services • Endpoints |

| Field Name | Usage Guidelines |
|-------------------|---|
| Issued To | Displays the common name of the certificate subject. |
| Issued By | Displays the common name of the certificate issuer. |
| Valid From | Displays the date and time when the certificate was issued. This value is also known as the “Not Before” certificate attribute. |
| Expiration Date | Displays the date and time when the certificate expires. This value is also known as the “Not After” certificate attribute. |
| Expiration Status | Provides information about the status of the certificate expiration. There are five icons and categories of informational message that are displayed in this column: <ul style="list-style-type: none"> • Green: Expiring in more than 90 days • Blue: Expiring in 90 days or less • Yellow: Expiring in 60 days or less • Orange: Expiring in 30 days or less • Red: Expired |

Related Topics

[Trusted Certificates Store](#), on page 151

[View Trusted Certificates](#), on page 154

[Change the Status of a Certificate in Trusted Certificates Store](#), on page 154

[Add a Certificate to Trusted Certificates Store](#), on page 154

Trusted Certificate Import Settings

Table 82: Trusted Certificate Import Settings

| Field Name | Description |
|-------------------------------------|--|
| Certificate File | Click Browse to choose the certificate file from the computer that is running the browser. |
| Friendly Name | Enter a friendly name for the certificate. If you do not specify a name, Cisco ISE automatically creates a name in the format <common name>#<issuer>#<nnnnn>, where <nnnnn> is a unique five-digit number. |
| Trust for authentication within ISE | Check the check box if you want this certificate to be used to verify server certificates (from other ISE nodes or LDAP servers). |

| Field Name | Description |
|---|---|
| Trust for client authentication and Syslog | (Applicable only if you check the Trust for authentication within ISE check box) Check the check box if you want this certificate to be used to: <ul style="list-style-type: none"> • Authenticate endpoints that connect to ISE using the EAP protocol • Trust a Syslog server |
| Trust for authentication of Cisco Services | Check this check box if you want this certificate to be used to trust external Cisco services such as the feed service. |
| Validate Certificate Extensions | (Only if you check both the Trust for client authentication and Enable Validation of Certificate Extensions options) Ensure that the “keyUsage” extension is present and the “keyCertSign” bit is set, and that the basic constraints extension is present with the CA flag set to true. |
| Description | Enter an optional description. |

Related Topics

[Trusted Certificates Store](#), on page 151

[Certificate Chain Import](#), on page 157

[Import a Root Certificate to Trusted Certificate Store](#), on page 156

OCSP Client Profile Settings

Table 83: OCSP Client Profile Settings

| Field Name | Usage Guidelines |
|---|--|
| Name | Name of the OCSP Client Profile. |
| Description | Enter an optional description. |
| Configure OCSP Responder | |
| Enable Secondary Server | Check this check box to enable a secondary OCSP server for high availability. |
| Always Access Primary Server First | Use this option to check the primary server before trying to move to the secondary server. Even if the primary was checked earlier and found to be unresponsive, Cisco ISE will try to send a request to the primary server before moving to the secondary server. |

| Field Name | Usage Guidelines |
|--|---|
| Fallback to Primary Server After Interval <i>n</i> Minutes | Use this option when you want Cisco ISE to move to the secondary server and then fall back to the primary server again. In this case, all other requests are skipped, and the secondary server is used for the amount of time that is configured in the text box. The allowed time range is 1 to 999 minutes. |
| Primary and Secondary Servers | |
| URL | Enter the URL of the primary and/or secondary OCSP server. |
| Enable Nonce Extension Support | You can configure a nonce to be sent as part of the OCSP request. The Nonce includes a pseudo-random number in the OCSP request. It is verified that the number that is received in the response is the same as the number that is included in the request. This option ensures that old communications cannot be reused in replay attacks. |
| Validate Response Signature | <p>The OCSP responder signs the response with one of the following certificates:</p> <ul style="list-style-type: none"> • The CA certificate • A certificate different from the CA certificate <p>In order for Cisco ISE to validate the response signature, the OCSP responder needs to send the response along with the certificate, otherwise the response verification fails, and the status of the certificate cannot be relied on. According to the RFC, OCSP can sign the response using different certificates. This is true as long as OCSP sends the certificate that signed the response for Cisco ISE to validate it. If OCSP signs the response with a different certificate that is not configured in Cisco ISE, the response verification will fail.</p> |
| Use OCSP URLs specified in Authority Information Access (AIA) | Click the radio button to use the OCSP URLs specified in the Authority Information Access extension. |
| Response Cache | |

| Field Name | Usage Guidelines |
|--|---|
| Cache Entry Time To Live <i>n</i> Minutes | <p>Enter the time in minutes after which the cache entry expires. Each response from the OCSP server holds a nextUpdate value. This value shows when the status of the certificate will be updated next on the server. When the OCSP response is cached, the two values (one from the configuration and another from response) are compared, and the response is cached for the period of time that is the lowest value of these two. If the nextUpdate value is 0, the response is not cached at all. Cisco ISE will cache OCSP responses for the configured time. The cache is not replicated or persistent, so when Cisco ISE restarts, the cache is cleared. The OCSP cache is used in order to maintain the OCSP responses and for the following reasons:</p> <ul style="list-style-type: none"> • To reduce network traffic and load from the OCSP servers on an already-known certificate • To increase the performance of Cisco ISE by caching already-known certificate statuses <p>By default, the cache is set to 2 minutes for the internal CA OCSP client profile. If an endpoint authenticates a second time within 2 minutes of the first authentication, the OCSP cache is used and the OCSP responder is not queried. If the endpoint certificate has been revoked within the cache period, the previous OCSP status of Good will be used and the authentication succeeds. Setting the cache to 0 minutes prevents any responses from being cached. This option improves security, but decreases authentication performance.</p> |
| Clear Cache | <p>Click Clear Cache to clear entries of all the certificate authorities that are connected to the OCSP service.</p> <p>In a deployment, Clear Cache interacts with all the nodes and performs the operation. This mechanism updates every node in the deployment.</p> |

Related Topics

[OCSP Services](#), on page 192

[Cisco ISE CA Service Online Certificate Status Protocol Responder](#), on page 192

[OCSP Certificate Status Values](#), on page 193

[OCSP High Availability](#), on page 193

[OCSP Failures](#), on page 193

[OCSP Statistics Counters](#), on page 194

[Add OCSP Client Profiles](#), on page 194

Internal CA Settings

Table 84: Internal CA Settings

| Field Name | Usage Guidelines |
|--|--|
| Disable Certificate Authority | Click this button to disable the internal CA service. |
| Host Name | Host name of the Cisco ISE node that is running the CA service. |
| Personas | Cisco ISE node personas that are enabled on the node running the CA service. For example, Administration, Policy Service, etc. |
| Role(s) | The role(s) assumed by the Cisco ISE node running the CA service. For example, Standalone or Primary or Secondary. |
| CA, EST & OCSP Responder Status | Enabled or disabled |
| OCSP Responder URL | URL for Cisco ISE node to access the OCSP server. |
| SCEP URL | URL for the Cisco ISE node to access the SCEP server. |

Related Topics

[Cisco ISE CA Service](#), on page 165

[Configure Cisco ISE to Use Certificates for Authenticating Personal Devices](#), on page 176

Certificate Template Settings



Note We do not support UTF-8 characters in the certificate template fields (Organizational Unit, Organization, City, State, and Country). Certificate provisioning fails if UTF-8 characters are used in the certificate template.

Table 85: Certificate Template Settings

| Field Name | Usage Guidelines |
|---------------------------------|--|
| Name | (Required) Enter a name for the certificate template. For example, Internal_CA_Template. |
| Description | (Optional) Enter a description. |
| Common Name (CN) | (Display only) Common name is autopopulated with the username. |
| Organizational Unit (OU) | Organizational Unit name. For example, Engineering. |
| Organization (O) | Organization name. For example, Cisco. |

| Field Name | Usage Guidelines |
|--------------------------------|---|
| City (L) | (Do not abbreviate) City name. For example, San Jose. |
| State (ST) | (Do not abbreviate) State name. For example, California. |
| Country (C) | Country name. You must enter the two-letter ISO country code. For example, US. |
| Subject Alternative Name (SAN) | (Display only) MAC address of the endpoint. |
| Key Type | RSA or ECC |
| Key Size | (Applicable only if you choose RSA) Specify a key size of 1024 or higher. |
| Curve Type | (Applicable only if you choose ECC) Specify a curve type (the default is P-384). |
| SCEP RA Profile | Choose the ISE Internal CA or an external SCEP RA profile that you have created. |
| Valid Period | Enter the number of days after which the certificate expires. |
| Extended Key Usage | |
| Client Authentication | Check this check box if you want to use this certificate for client authentication. |
| Server Authentication | Check this check box if you want to use this certificate for server authentication. |

Related Topics

[Certificate Templates](#), on page 170

[Certificate Template Name Extension](#), on page 170

[Configure Cisco ISE to Use Certificates for Authenticating Personal Devices](#), on page 176

[Deploy Cisco ISE CA Certificates for pxGrid Controller](#), on page 171

[Use Certificate Template Name in Authorization Policy Conditions](#), on page 171

Logging Settings

The following sections explain how to configure the severity of debug logs, create an external log target, and enable Cisco ISE to send log messages to these external log targets.

Remote Logging Target Settings

The following table describes the fields in the **Remote Logging Targets** window that you can use to create external locations (syslog servers) to store logging messages. The navigation path for this window is **Administration > System > Logging > Remote Logging Targets**. click **Add**.

Table 86: Remote Logging Target Settings

| Field Name | Usage Guidelines |
|--|---|
| Name | Enter a name for the new syslog target. |
| Target Type | Select the target type from the drop-down list. The default value is UDP Syslog . |
| Description | Enter a brief description of the new target. |
| IP Address | Enter the IP address or hostname of the destination machine that will store the logs. |
| Port | Enter the port number of the destination machine. |
| Facility Code | Choose the syslog facility code that must be used for logging from the drop-down list. Valid options are Local0 through Local7. |
| Maximum Length | Enter the maximum length of the remote log target messages. Valid values are from 200 through 1024 bytes. |
| Buffer Message When Server Down | This check box is displayed when you choose TCP Syslog or Secure Syslog from the Target Type drop-down list. Check this check box to allow Cisco ISE to buffer the syslog messages when a TCP syslog target or secure syslog target is unavailable. Cisco ISE retries sending messages to the target when the connection to the target resumes. After the connection resumes, messages are sent sequentially, starting with the oldest and proceeding to the newest. Buffered messages are always sent before new messages. If the buffer is full, old messages are discarded. |
| Buffer Size (MB) | Set the buffer size for each target. By default, it is set to 100 MB. Changing the buffer size clears the buffer and all the existing buffered messages for the specific target are lost. |
| Reconnect Timeout (Sec) | Enter the time (in seconds) to configure how long the TCP and secure syslogs are stored for before being discarded when the server is down. |
| Select CA Certificate | This drop-down list is displayed when you choose Secure Syslog from the Target Type drop-down list. Choose a client certificate from the drop-down list. |

| Field Name | Usage Guidelines |
|---|--|
| Ignore Server Certificate Validation | This check box is displayed when you choose Secure Syslog from the Target Type drop-down list. Check this check box for Cisco ISE to ignore server certificate authentication and accept any syslog server. By default, this option is set to off unless the system is in FIPS mode when this is disabled. |

Related Topics

[Cisco ISE Logging Mechanism](#), on page 269

[Cisco ISE System Logs](#), on page 270

[Cisco ISE Message Catalogs](#), on page 272

[Collection Filters](#), on page 275

[Event Suppression Bypass Filter](#), on page 275

[Configure Remote Syslog Collection Locations](#), on page 270

[Configure Collection Filters](#), on page 275

Configure Logging Categories

The following table describes the fields that you can use to configure a logging category. Set a log severity level and choose the logging targets for the logs of a logging category. The navigation path for this window is **Administration > System > Logging > Logging Categories**.

Click the radio button next to the logging category that you want to view, and click **Edit**. The following table describes the fields that are displayed in the edit window of the logging categories.

Table 87: Logging Category Settings

| Field Name | Usage Guidelines |
|-------------|--|
| Name | Displays the name of the logging category. |

| Field Name | Usage Guidelines |
|---------------------------|--|
| Log Severity Level | <p>For some logging categories, this value is set by default, and you cannot edit it. For some logging categories, you can choose one of the following severity levels from a drop-down list:</p> <ul style="list-style-type: none"> • FATAL: Emergency level. This level means that you cannot use Cisco ISE and you must immediately take the necessary action. • ERROR: This level indicates a critical error condition. • WARN: This level indicates a normal but significant condition. This is the default level set for many logging categories. • INFO: This level indicates an informational message. • DEBUG: This level indicates a diagnostic bug message. |
| Local Logging | Check this check box to enable logging events for a category on the local node. |
| Targets | This area allows you to choose the targets for a logging category by transferring the targets between the Available and the Selected areas using the left and right arrow icons. The Available area contains the existing logging targets, both local (predefined) and external (user-defined). The Selected area, which is initially empty, then displays the targets that have been chosen for the category. |

Related Topics

[Cisco ISE Message Codes](#), on page 272

[Configure Remote Syslog Collection Locations](#), on page 270

[Set Severity Levels for Message Codes](#), on page 272

Maintenance Settings

These windows help you to manage data using the backup, restore, and data purge features.

Repository Settings

Table 88: Repository Settings

| Fields | Usage Guidelines |
|----------------------------------|---|
| Repository | Enter the name of the repository. Alphanumeric characters are allowed and the maximum length is 80 characters. |
| Protocol | Choose one of the available protocols that you want to use. |
| Server Name | (Required for TFTP, HTTP, HTTPS, FTP, SFTP, and NFS) Enter the hostname or IPv4 address of the server where you want to create the repository.

Note Ensure that the ISE eth0 interface is configured with an IPv6 address if you are adding a repository with an IPv6 address. |
| Path | Enter the path to your repository. The path must be valid and must exist at the time you create the repository.

This value can start with two forward slashes (//) or a single forward slash (/) denoting the root directory of the server. However, for the FTP protocol, a single forward slash (/) denotes the FTP of the local device home directory and not the root directory. |
| Enable PKI authentication | (Optional; applicable only for SFTP repository) Check this check box if you want to enable RSA Public Key Authentication in SFTP repository. |
| User Name | (Required for FTP, SFTP, and NFS) Enter the username that has write permission to the specified server. A username can contain alphanumeric and _ - . / @ \ \$ characters. |
| Password | (Required for FTP, SFTP, and NFS) Enter the password that will be used to access the specified server. Passwords can consist of the following characters: 0 to 9, a to z, A to Z, -, ., , @, #, \$, ^, &, *, (,), +, and =. |

Related Topics

[Backup and Restore Repositories](#), on page 278

[Create Repositories](#), on page 278

On-Demand Backup Settings

The following table describes the fields on the **On-Demand Backup** window, which you can use to obtain a backup at any point of time. The navigation path for this window is **Administration > System > Backup & Restore**.

Table 89: On-Demand Backup Settings

| Field Name | Usage Guidelines |
|------------------------|---|
| Backup Name | Enter the name of your backup file. |
| Repository Name | Repository where your backup file should be saved. You cannot enter a repository name here. You can only choose an available repository from the drop-down list. Ensure that you create the repository before you run a backup. |
| Encryption Key | This key is used to encrypt and decrypt the backup file. |

Related Topics

[Backup Data Type](#), on page 277

[On-Demand and Scheduled Backups](#), on page 280

[Backup History](#), on page 284

[Backup Failures](#), on page 285

[Cisco ISE Restore Operation](#), on page 285

[Export Authentication and Authorization Policy Configuration](#), on page 292

[Synchronize Primary and Secondary Nodes in a Distributed Environment](#), on page 292

[Perform an On-Demand Backup](#), on page 281

Scheduled Backup Settings

The following table describes the fields on the Scheduled Backup window, which you can use to restore a full or incremental backup. The navigation path for this window is **Administration > System > Backup and Restore**.

Table 90: Scheduled Backup Settings

| Field Name | Usage Guidelines |
|--------------------|---|
| Name | Enter a name for your backup file. You can enter a descriptive name of your choice. Cisco ISE appends the timestamp to the backup filename and stores it in the repository. You will have unique backup filenames even if you configure a series of backups. On the Scheduled Backup list window, the backup filename will be prepended with “backup_occur” to indicate that the file is an occurrence kron job. |
| Description | Enter a description for the backup. |

| Field Name | Usage Guidelines |
|-------------------------|--|
| Repository Name | Select the repository where your backup file should be saved. You cannot enter a repository name here. You can only choose an available repository from the drop-down list. Ensure that you create the repository before you run a backup. |
| Encryption Key | Enter a key to encrypt and decrypt the backup file. |
| Schedule Options | Choose the frequency of your scheduled backup and fill in the other options accordingly. |

Related Topics

[Backup Data Type](#), on page 277

[On-Demand and Scheduled Backups](#), on page 280

[Backup History](#), on page 284

[Backup Failures](#), on page 285

[Cisco ISE Restore Operation](#), on page 285

[Export Authentication and Authorization Policy Configuration](#), on page 292

[Synchronize Primary and Secondary Nodes in a Distributed Environment](#), on page 292

[Backup Using the CLI](#), on page 284

[Schedule a Backup](#), on page 283

Admin Access Settings

These sections enable you to configure access settings for administrators.

Administrator Password Policy Settings

The following table describes the fields in the **Password Policy** tab that you can use to define a criteria that administrator passwords should meet. The navigation path for this window is: **Administration > System > Admin Access > Authentication > Password Policy**.

Table 91: Administrator Password Policy Settings

| Field Name | Usage Guidelines |
|-----------------------|--|
| Minimum Length | Specify the minimum length of the password (in characters). The default is six characters. |

| Field Name | Usage Guidelines |
|----------------------------------|---|
| Password must not contain | Admin name or its characters in reverse order:
Check this check box to restrict the use of the administrator username or its characters in reverse order as the password. |
| | Cisco or its characters in reverse order: Check this check box to restrict the use of the word Cisco or its characters in the reverse order as the password. |
| | This word or its characters in reverse order: Check this check box to restrict the use of any word that you define or its characters in the reverse order as the password. |
| | Repeated characters four or more times consecutively: Check this check box to restrict the use of repeated characters four or more times consecutively as the password. |
| | Dictionary words, their characters in reverse order, or their letters replaced with other characters: Check this check box to restrict the use of dictionary words, their characters in reverse order, or their letters replaced with other characters, as the password.

Substitution of \$ for s, @ for a, 0 for o, 1 for l, ! for i, 3 for e, and so on, is not permitted. For example, Pa\$\$w0rd is not permitted. <ul style="list-style-type: none"> • Default Dictionary: Choose this option to use the default Linux dictionary in Cisco ISE. The default dictionary contains approximately 480,000 English words.

This option is selected by default. • Custom Dictionary: Choose this option to use your customized dictionary. Click Browse to select a custom dictionary file. The text file must be of newline-delimited words, .dic extension, and size less than 20 MB. |

| Field Name | Usage Guidelines |
|---|---|
| Password must contain at least one character of each of the selected types | <p>Check the check box for the type of characters an administrator's password must contain. Choose one or more of the following options:</p> <ul style="list-style-type: none"> • Lowercase alphabetic characters • Uppercase alphabetic characters • Numeric characters • Non-alphanumeric characters |
| Password History | <p>Specify the number of previous passwords from which the new password must be different to prevent the repeated use of the same password. Check the Password must be different from the previous <i>n</i> versions check box, and enter the number in the corresponding field.</p> <p>Also, specify the number of characters that must be different from the previous password.</p> <p>Enter the number of days before which you cannot reuse a password. Check the Cannot reuse password within <i>n</i> days check box, and enter the number in the corresponding field.</p> |
| Password Lifetime | <p>Check the check boxes for the following options to force users to change passwords after a specified time period:</p> <ul style="list-style-type: none"> • Administrator passwords expire <i>n</i> days after creation or last change: Time (in days) before the administrator account is disabled if the password is not changed. The valid range is 1 to 3650 days. • Send an email reminder to administrators <i>n</i> days prior to password expiration: Time (in days) before which the administrator is reminded that their password will expire. The valid range is 1 to 3650 days. |
| Lock or Suspend Account with Incorrect Login Attempts | <p>Specifies the number of times Cisco ISE records incorrect administrator passwords before locking the administrator out of Cisco ISE, and suspending or disabling account credentials.</p> <p>An e-mail is sent to the administrator whose account gets locked out. You can enter a custom e-mail remediation message.</p> |
| Display Network Device-Sensitive Data | |

| Field Name | Usage Guidelines |
|---|---|
| Require Admin Password | Check this check box if you want the admin user to enter the login password to view network device-sensitive data such as shared secrets and passwords. |
| Password cached for <i>n</i> Minutes | The password that is entered by the admin user is cached for this time period. The admin user will not be prompted to enter the password again during this period to view the network device sensitive data. The valid range is from 1 to 60 minutes. |

Related Topics

[Cisco ISE Administrators](#), on page 97

[Create a New Administrator](#), on page 98

Session Timeout and Session Information Settings

The following table describes the fields in the **Session** window that you can use to define session timeout and terminate an active administrative session. The navigation path for this window is: **Administration > System > Admin Access > Settings > Session**.

Table 92: Session Timeout and Session Information Settings

| Field Name | Usage Guidelines |
|-----------------------------|---|
| Session Timeout | |
| Session Idle Timeout | Enter the time, in minutes, that you want Cisco ISE to wait for it logs out the administrator if there is no activity. The default value is 60 minutes. The valid range is from 6 to 100 minutes. |
| Session Info | |
| Invalidate | Check the check box adjacent to the session ID that you want to terminate and click Invalidate . |

Related Topics

[Administrator Access Settings](#), on page 113

[Configure Session Timeout for Administrators](#), on page 116

[Terminate an Active Administrative Session](#), on page 116

General TrustSec Settings

Verify Trustsec Deployment

This option helps you to verify that the latest TrustSec policies are deployed on all network devices. Alarms are displayed in the Alarms dashlet, under **Work Centers > TrustSec > Dashboard and Home > Summary**, if there are any discrepancies between the policies configured on Cisco ISE and on the network device. The following alarms are displayed in the TrustSec dashboard:

- An alarm displays with an **Info** icon whenever the verification process starts or completes.
- An alarm displays with an **Info** icon if the verification process was cancelled due to a new deployment request.
- An alarm displays with a **Warning** icon if the verification process fails with an error. For example, failure to open the SSH connection with the network device, or if the network device is unavailable, or if there is any discrepancy between the policies configured on Cisco ISE and on the network device.

The **Verify Deployment** option is also available from the below windows.

- **Work Centers > TrustSec > Components > Security Groups**
- **Work Centers > TrustSec > Components > Security Group ACLs**
- **Work Centers > TrustSec > TrustSec Policy > Egress Policy > Matrix**
- **Work Centers > TrustSec > TrustSec Policy > Egress Policy > Source Tree**
- **Work Centers > TrustSec > TrustSec Policy > Egress Policy > Destination Tree**

Automatic Verification After Every Deploy: Check this check box if you want Cisco ISE to verify the updates on all the network devices after every deployment. When the deployment process is complete, the verification process starts after the time you specify in the **Time after Deploy Process** field.

Time After Deploy Process: Specify the time for which you want Cisco ISE to wait for after the deployment process is complete, before starting the verification process. The valid range is 10–60 minutes.

The current verification process is cancelled if a new deployment request is received during the waiting period or if another verification is in progress.

Verify Now: Click this option to start the verification process immediately.

Protected Access Credential (PAC)

- **Tunnel PAC Time to Live :**

Specify the expiry time for the PAC. The tunnel PAC generates a tunnel for the EAP-FAST protocol. You can specify the time in seconds, minutes, hours, days, or weeks. The default value is 90 days. The following are the valid ranges:

- 1–157680000 seconds
- 1–2628000 minutes
- 1–43800 hours
- 1–1825 days

- 1–260 weeks

- **Proactive PAC Update Will Occur After:** Cisco ISE proactively provides a new PAC to a client after successful authentication when a configured percentage of the Tunnel PAC TTL remains. The server starts the tunnel PAC update if the first successful authentication occurs before the PAC expires. This mechanism updates the client with a valid PAC. The default value is 10%.

Security Group Tag Numbering

- **System will Assign SGT Numbers:** Choose this option if you want Cisco ISE to automatically generate the SGT numbers.
- **Except Numbers in Range:** Choose this option to reserve a range of SGT numbers for manual configuration. Cisco ISE will not use the values in this range while generating the SGTs.
- **User Must Enter SGT Numbers Manually:** Choose this option to define the SGT numbers manually.

Security Group Tag Numbering for APIC EPGs

Security Group Tag Numbering for APIC EPGs : Check this check box and specify the range of numbers to be used for the SGTs created based on the EPGs learnt from APIC.

Automatic Security Group Creation

Auto Create Security Groups When Creating Authorization Rules: Check this check box to create the SGTs automatically while creating the authorization policy rules.

If you select this option, the following message displays at the top of the **Authorization Policy** window: `Auto Security Group Creation is On`

The autocreated SGTs are named based on the rule attributes. Click the **plus (+)** sign displayed in the **Permissions** field to edit the SGT name and value.



Note The autocreated SGTs are not deleted if you delete the corresponding authorization policy rule.

By default, this option is disabled after a fresh install or upgrade.

- **Automatic Naming Options:** Use this option to define the naming convention for the autocreated SGTs. (Mandatory) **Name Will Include:** Choose one of the following options:
 - **Rule name**
 - **SGT number**
 - **Rule name and SGT number**

By default, the **Rule name** option is selected.

Optionally, you can add the following information to the SGT name:

- **Policy Set Name** (this option is available only if **Policy Sets** are enabled)
- **Prefix** (up to 8 characters)

- **Suffix** (up to 8 characters)

Cisco ISE displays a sample SGT name in the **Example Name** field, based on your selections.

If an SGT exists with the same name, ISE appends `_x` to the SGT name, where `x` is the first value, starting with 1 (if 1 is not used in the current name). If the new name is longer than 32 characters, Cisco ISE truncate its to the first 32 characters.

IP SGT static mapping of hostnames

IP SGT Static Mapping of Hostnames: If you use FQDN and hostnames, Cisco ISE looks for the corresponding IP addresses in the PAN and PSN nodes while deploying the mappings and checking the deployment status. You can use this option to specify the number of mappings that are created for the IP addresses returned by the DNS query. You can select one of the following options:

- **Create mappings for all IP addresses returned by a DNS query**
- **Create mappings only for the first IPv4 address and the first IPv6 address that is returned by a DNS query**

Related Topics

[TrustSec Architecture](#), on page 793

[TrustSec Components](#), on page 794

[Configure TrustSec Global Settings](#), on page 799

Settings

These windows enable you to configure general settings for the various services.

Posture General Settings

These settings are the default settings for posture, which can be overridden by a posture profile.

General Posture Settings

- **Remediation Timer:** Enter the time to wait before starting remediation. The default value is 4 minutes. The valid range is 1–300 minutes.
- **Network Transition Delay:** Enter a time value in seconds. The default value is 3 seconds. The valid range is from 2 to 30 seconds.
- **Default Posture Status:** Choose **Compliant** or **Noncompliant**. Non-agent devices assume this status while connecting to the network.
- **Automatically Close Login Success Screen After:** Check the check box to close the login success screen automatically after the specified time. You can configure the timer to close the login screen automatically. The valid range is from 0 to 300 seconds. If the time is set to zero, then the agents on the client do not display the login success screen.
- **Continuous Monitoring Interval:** Specify the time interval after which AnyConnect should start sending monitoring data. For application conditon , the default value is 5 minutes.

- **Acceptable Use Policy in Stealth Mode:** Choose **Block** in stealth mode to move a client to noncompliant posture status, if your company's network-usage terms and conditions are not met.

Posture Lease

- **Perform posture assessment every time a user connects to the network:** Select this option to initiate posture assessment every time the user connects to network
- **Perform posture assessment every n days:** Select this option to initiate posture assessment after the specified number of days, even if the client is already postured Compliant.

Related Topics

[Posture Service](#), on page 758

[Posture Administration Settings](#), on page 761

[Posture Lease](#), on page 764

[Enable Posture Session Service in Cisco ISE](#), on page 761

[Set Remediation Timer for Clients to Remediate Within Specified Time](#), on page 762

[Set Network Transition Delay Timer for Clients to Transition](#), on page 762

[Set Login Success Window to Close Automatically](#), on page 763

[Set Posture Status for Nonagent Devices](#), on page 763

Posture Reassessment Configuration Settings

Table 93: Posture Reassessment Configuration Settings

| Field Name | Usage Guidelines |
|-------------------------------|---|
| Configuration Name | Enter the name of PRA configuration. |
| Configuration Description | Enter a description for PRA configuration. |
| Use Reassessment Enforcement? | Check the check box to apply the PRA configurations for the user identity groups. |

| Field Name | Usage Guidelines |
|-------------------------|---|
| Enforcement Type | <p>Choose the action to be enforced:</p> <ul style="list-style-type: none"> • Continue: The user continues to have the privileged access without any user intervention to remediate the client irrespective of the posture requirement. • Logoff: If the client is not compliant, the user is forced to logoff from the network. When the client logs in again, the compliance status is unknown. • Remediate: If the client is not compliant, the agent waits for a specified time for the remediation to happen. Once the client has remediated, the agent sends the PRA report to the policy service node. If the remediation is ignored on the client, then the agent sends a logoff request to the policy service node to force the client to logoff from the network. <p>If the posture requirement is set to mandatory, then the RADIUS session will be cleared as a result of the PRA failure action and a new RADIUS session has to start for the client to be postured again.</p> <p>If the posture requirement is set to optional, then the agent on the client allows the user to click the continue option from the agent. The user can continue to stay in the current network without any restriction.</p> |
| Interval | <p>Enter a time interval in minutes to initiate PRA on the clients after the first successful login.</p> <p>The default value is 240 minutes. Minimum value is 60 minutes and maximum is 1440 minutes.</p> |
| Grace time | <p>Enter a time interval in minutes to allow the client to complete remediation. The grace time cannot be zero, and should be greater than the PRA interval. It can range between the default minimum interval (5 minutes) and the minimum PRA interval.</p> <p>The minimum value is 5 minutes and the maximum value is 60 minutes.</p> <p>Note The grace time is enabled only when the enforcement type is set to remediate action after the client fails the posture reassessment.</p> |

| Field Name | Usage Guidelines |
|-----------------------------|---|
| Select User Identity Groups | Choose a unique group or a unique combination of groups for your PRA configuration. |
| PRA configurations | Displays existing PRA configurations and user identity groups associated to PRA configurations. |

Related Topics

[Posture Lease](#), on page 764

[Periodic Reassessments](#), on page 764

[Posture Assessment Options](#), on page 775

[Posture Remediation Options](#), on page 776

[Custom Conditions for Posture](#), on page 777

[Custom Posture Remediation Actions](#), on page 777

[Configure Periodic Reassessments](#), on page 765

Posture Acceptable Use Policy Configuration Settings

Table 94: Posture AUP Configurations Settings

| Field Name | Usage Guidelines |
|--|---|
| Configuration Name | Enter the name of the AUP configuration that you want to create. |
| Configuration Description | Enter the description of the AUP configuration that you want to create. |
| Show AUP to Agent users (for Windows only) | When selected, the link to network usage terms and conditions for your network is displayed to users upon successful authentication and posture assessment. |
| Use URL for AUP message | When selected, you must enter the URL to the AUP message in the AUP URL field. |
| Use file for AUP message | When selected, you must browse to the location and upload a file in a zipped format. The file must contain the index.html at the top level.

The .zip file can include other files and subdirectories in addition to the index.html file. These files can reference each other using HTML tags. |
| AUP URL | Enter the URL to the AUP, which users must access upon successful authentication and posture assessment. |
| AUP File | Browse to the file and upload it to the Cisco ISE server. It should be a zipped file and should contain the index.html file at the top level. |

| Field Name | Usage Guidelines |
|--|--|
| Select User Identity Groups | <p>Choose a unique user identity group or a unique combination of user identity groups for your AUP configuration.</p> <p>Note the following while creating an AUP configuration:</p> <ul style="list-style-type: none"> • Posture AUP is not applicable for a guest flow • No two configurations have any user identity group in common • If you want to create a AUP configuration with a user identity group “Any”, then delete all other AUP configurations first • If you create a AUP configuration with a user identity group “Any”, then you cannot create other AUP configurations with a unique user identity group or user identity groups. To create an AUP configuration with a user identity group other than Any, either delete an existing AUP configuration with a user identity group “Any” first, or update an existing AUP configuration with a user identity group “Any” with a unique user identity group or user identity groups. |
| Acceptable use policy configurations—Configurations list | Lists existing AUP configurations and end user identity groups associated with AUP configurations. |

Related Topics

[Posture Service](#), on page 758

[Configure Acceptable Use Policies for Posture Assessment](#), on page 767

EAP-FAST Settings

Table 95: Configuring EAP-FAST Settings

| Field Name | Usage Guidelines |
|-------------------------------------|--|
| Authority Identity Info Description | Enter a user-friendly string that describes the Cisco ISE node that sends credentials to a client. The client can discover this string in the Protected Access Credentials (PAC) information for type, length, and value (TLV). The default value is Identity Services Engine. |

| Field Name | Usage Guidelines |
|--|--|
| Master Key Generation Period | Specifies the primary key generation period in seconds, minutes, hours, days, or weeks. The value must be a positive integer in the range 1 to 2147040000 seconds. The default is 604800 seconds, which is equivalent to one week. |
| Revoke all master keys and PACs | Click Revoke to revoke all primary keys and PACs. |
| Enable PAC-less Session Resume | Check this check box if you want to use EAP-FAST without the PAC files. |
| PAC-less Session Timeout | Specifies the time in seconds after which the PAC-less session resume times out. The default is 7200 seconds. |

Related Topics

[Protocol Settings for Authentication](#), on page 571

[Guidelines for Using EAP-FAST as Authentication Protocol](#), on page 571

[Benefits of EAP-FAST](#), on page 1176

[Configure EAP-FAST Settings](#), on page 572

PAC Settings


The following table describes the fields on the Generate PAC window, which you can use to configure protected access credentials for EAP-FAST authentication. The navigation path for this page is: To view this window, click the **Menu** icon () and choose **Administration > System > Settings > Protocols > EAP-FAST > Generate PAC**.

Table 96: Generating PAC for EAP-FAST Settings

| Field Name | Usage Guidelines |
|---------------------|---|
| Tunnel PAC | Click this radio button to generate a tunnel PAC. |
| Machine PAC | Click this radio button to generate a machine PAC. |
| Trustsec PAC | Click this radio button to generate a Trustsec PAC. |

| Field Name | Usage Guidelines |
|-------------------------|--|
| Identity | <p>(For Tunnel and Machine PAC) Specifies the username or machine name that is presented as the “inner username” by the EAP-FAST protocol. If the identity string does not match that username, authentication fails.</p> <p>This is the hostname as defined on the Adaptive Security Appliance (ASA). The identity string must match the ASA hostname otherwise, ASA cannot import the PAC file that is generated.</p> <p>If you are generating a Trustsec PAC, the Identity field specifies the Device ID of a Trustsec network device and is provided with an initiator ID by the EAP-FAST protocol. If the Identity string entered here does not match that Device ID, authentication fails.</p> |
| PAC Time to Live | <p>(For Tunnel and Machine PAC) Enter a value in seconds that specifies the expiration time for the PAC. The default is 604800 seconds, which is equivalent to one week. This value must be a positive integer between 1 and 157680000 seconds. For the Trustsec PAC, enter a value in days, weeks, months, or years. By default, the value is one year. The minimum value is one day and the maximum is 10 years.</p> |
| Encryption Key | <p>Enter an encryption key. The length of the key must be between 8 and 256 characters. The key can contain uppercase or lowercase letters, or numbers, or a combination of alphanumeric characters.</p> |
| Expiration Data | <p>(For Trustsec PAC only) The expiration date is calculated based on the PAC Time to Live.</p> |

Related Topics

[Protocol Settings for Authentication](#), on page 571

[Guidelines for Using EAP-FAST as Authentication Protocol](#), on page 571

[Generate the PAC for EAP-FAST](#), on page 572

EAP-TTLS Settings

Table 97: EAP-TTLS Settings

| Field Name | Usage Guidelines |
|---------------------------------------|---|
| Enable EAP-TTLS Session Resume | <p>If you check this check box, Cisco ISE will cache the TLS session that is created during phase one of EAP-TTLS authentication, provided the user successfully authenticates in phase two of EAP-TTLS. If a user needs to reconnect and the original EAP-TTLS session has not timed out, Cisco ISE uses the cached TLS session, resulting in faster EAP-TTLS performance and a reduced AAA server load.</p> <p>Note When the EAP-TTLS session is resumed, the inner method is skipped.</p> |
| EAP-TTLS Session Timeout | <p>Specifies the time in seconds after which the EAP-TTLS session times out. The default value is 7200 seconds.</p> |

Related Topics

- [Protocol Settings for Authentication](#), on page 571
- [Using EAP-TTLS as Authentication Protocol](#), on page 572
- [Configure EAP-TTLS Settings](#), on page 573

EAP-TLS Settings

Related Topics

- [Protocol Settings for Authentication](#), on page 571
- [Configure EAP-TLS Settings](#), on page 573

PEAP Settings

Related Topics

- [Protocol Settings for Authentication](#), on page 571
- [Configure PEAP Settings](#), on page 574
- [Advantages of Using PEAP](#), on page 1174
- [Supported Supplicants for the PEAP Protocol](#), on page 1174
- [PEAP Protocol Flow](#), on page 1175

RADIUS Settings

If you enable the **Suppress Repeated Failed Clients** option, clients with repeated authentication failures will be suppressed from the audit logs, and the requests from these clients will be automatically rejected for the specified time period. You can also specify the number of authentication failures after which the requests

from these clients should be rejected. For example, if this value is configured as 5, when a client authentication fails five times, all the requests received from that client will be rejected for the configured time period.



Note If the cause of authentication failure is entry of wrong password, the client will not be suppressed.



Note If you configure suppression of RADIUS failures, you may still receive the error "5440 Endpoint Abandoned EAP Session and started a new one" after you configure RADIUS log suppression. For more information, see the following ISE Community post:

<https://community.cisco.com/t5/network-access-control/authentication-failed-quot-5440-endpoint-abandoned-eap-session/td-p/3191944>

Table 98: RADIUS Settings

| Field Name | Usage Guidelines |
|---|---|
| Suppress Repeated Failed Clients | |
| Suppress Repeated Failed Clients | Check this check box to suppress the clients for which the authentications fail repeatedly for the same reason. These clients are suppressed from the audit logs and the requests from these clients are rejected for the specified time period if Reject RADIUS Requests from Clients with Repeated Failures option is enabled. |
| Detect Two Failures Within | Enter the time interval in minutes. If a client fails authentication twice for the same reason within this time period, it will be suppressed from the audit logs, and the requests from this client will be rejected if Reject RADIUS Requests from Clients with Repeated Failures option is enabled. |
| Report Failures Once Every | Enter the time interval in minutes for the failed authentications to be reported. For example, if this value is set as 15 minutes, clients that repeatedly fail authentication will be reported in the audit logs only once every 15 minutes, thereby preventing over-reporting. |
| Reject RADIUS Requests from Clients with Repeated Failures | Check this check box to automatically reject the RADIUS requests from the clients for which the authentications fail repeatedly. You can enable this option to avoid unnecessary processing by Cisco ISE and to protect against potential denial of service attacks. |

| Field Name | Usage Guidelines |
|---|--|
| Failures Prior to Automatic Rejection | Enter the number of authentication failures after which requests from clients with repeated failures are automatically rejected. All the requests received from these clients are automatically rejected for the configured time period (specified in Continue Rejecting Requests for field). After the interval expires, the authentication requests from these clients are processed. |
| Continue Rejecting Requests for | Enter the time interval (in minutes) for which the requests from clients with repeated failures are to be rejected. |
| Ignore Repeated Accounting Updates Within | Repeated accounting updates that occur within this period will be ignored. |
| Suppress Successful Reports | |
| Suppress Repeated Successful Authentications | Check this check box to prevent repeated reporting of successful authentication requests in last 24 hours that have no change in identity context, network device, and authorization. |
| Authentications Details | |
| Highlight Steps Longer Than | Enter the time interval in milliseconds. If execution of a single step exceeds the specified threshold, it will be marked with a clock icon in the authentication details window. |
| RADIUS UDP Ports | |
| Authentication Ports | Specify the ports to be used for RADIUS UDP authentication flows. You can specify a maximum of 4 port numbers (separated by a comma). By default, port 1812 and port 1645 are used. The valid range is from 1024 to 65535. |
| Accounting Ports | Specify the ports to be used for RADIUS UDP accounting flows. You can specify a maximum of 4 port numbers (separated by a comma). By default, port 1813 and port 1646 are used. The valid range is from 1024 to 65535.

Note Ensure that these ports are not used by other services. |
| RADIUS DTLS | |

| Field Name | Usage Guidelines |
|---|---|
| Authentication and Accounting Port | <p>Specify the port to be used for RADIUS DTLS authentication and accounting flows. By default, port 2083 is used. The valid range is from 1024 to 65535.</p> <p>Note Ensure that this port is not used by other services.</p> |
| Idle Timeout | <p>Enter the time (in seconds) that you want Cisco ISE to wait before it closes the TLS session if no packets are received from the network device. Default value is 120 seconds. The valid range is from 60 to 600 seconds.</p> |

Related Topics

[Protocol Settings for Authentication](#), on page 571

[RADIUS Protocol Support in Cisco ISE](#), on page 1170

[Configure RADIUS Settings](#), on page 574

TrustSec Matrix Settings

Table 99: Configuring TrustSec Matrix Settings

| Field Name | Usage Guidelines |
|------------------------------|--|
| Allow Multiple SGACLs | <p>Check this check box if you want to allow multiple SGACLs in a cell. If this option is not selected, Cisco ISE will allow only one SGACL per cell.</p> <p>By default, this option is disabled upon fresh install.</p> <p>After upgrade, Cisco ISE will scan the Egress cells and if it identifies at least one cell with multiple SGACLs assigned to it, it allows the admin to add multiple SGACLs in a cell. Otherwise, it allows only one SGACL per cell.</p> <p>Note Before disabling multiple SGACLs, you must edit the cells containing multiple SGACLs to include only one SGACL.</p> |
| Allow Monitoring | <p>Check this check box to enable monitoring for all cells in the matrix. If monitoring is disabled, Monitor All icon is greyed out and the Monitor option is disabled in the Edit Cell dialog.</p> <p>By default, monitoring is disabled upon fresh install.</p> <p>Note Before disabling monitoring at matrix level, you must disable monitoring for the cells that are currently being monitored.</p> |

| Field Name | Usage Guidelines |
|----------------------------|---|
| Show SGT Numbers | Use this option to display or hide the SGT values (both decimal and hexadecimal) in the matrix cells.

By default, the SGT values are displayed in the cells. |
| Appearance Settings | The following options are available: <ul style="list-style-type: none"> • Custom settings: The default theme (colors with no patterns) is displayed initially. You can set your own colors and patterns. • Default settings: Predefined list of colors with no patterns (not editable). • Accessibility settings: Predefined list of colors with patterns (not editable). |
| Color/Pattern | To make the matrix more readable, you can apply coloring and patterns to the matrix cells based on the cell contents.

The following display types are available: <ul style="list-style-type: none"> • Permit IP/Permit IP Log: Configured inside the cell • Deny IP/Deny IP Log: Configured inside the cell • SGACLs: For SGACLs configured inside the cell • Permit IP/Permit IP Log (Inherited): Taken from the default policy (for non-configured cells) • Deny IP/Deny IP Log (Inherited): Taken from the default policy (for non-configured cells) • SGACLs (Inherited): Taken from the default policy (for non-configured cells) |

Related Topics

[Egress Policy](#), on page 809

[Matrix View](#), on page 810

[Configure TrustSec Matrix Settings](#), on page 800

SMS Gateway Settings

Use these settings to configure sending SMS messages to guests and sponsors via an email server.

Table 100: SMS Gateway Settings for SMS Email Gateway

| Field | Usage Guidelines |
|------------------------------|--|
| SMS Gateway Provider Domain | Enter the provider domain, which is used as the host portion and the guest account's mobile number as the user portion of the email address to send the message to the provider's SMS/MMS gateway. |
| Provider account address | (Optional)
Enter the account address, which is used as the FROM address (typically the account address) for the email and overrides the Default Email Address global setting in Guest Access > Settings . |
| SMTP API destination address | (Optional)
Enter the SMTP API Destination Address, if you are using an SMTP SMS API that requires a specific account recipient address, such as Clickatell SMTP API.

This is used as the TO address for the email and the guest account's mobile number is substituted into the message's body template. |
| SMTP API body template | (Optional)
Enter the SMTP API Body Template, if you are using an SMTP SMS API that requires a specific email body template for sending the SMS, such as Clicketell SMTP API.

The supported dynamic substitutions are \$mobilenumber\$, \$timestamp\$ (of format \$YYYYMMDDHHMISSmimi\$), and \$message\$. You can use \$timestamp\$\$mobilenumber\$ for SMS gateways that require a unique idenitifier in the URL. |

The navigation path for these settings is **Guest Access > Settings > SMS Gateway**.

Use these settings to configure sending SMS messages to guests and sponsors via an HTTP API (GET or POST method).

Table 101: SMS Gateway Settings for SMS HTTP API

| Field | Usage Guidelines |
|--|---|
| URL | <p>Enter the URL for the API.</p> <p>This field is not URL encoded. The guest account's mobile number is substituted into the URL. The supported dynamic substitutions are \$mobilenumber\$ and \$message\$.</p> <p>If you are using HTTPS with the HTTP API, include HTTPS in the URL string and upload your provider's trusted certificates into Cisco ISE. Choose Administration > System > Certificates > Trusted Certificates.</p> |
| Data (Url encoded portion) | <p>Enter the Data (Url encoded portion) for the GET or POST request.</p> <p>This field is URL encoded. If using the default GET method, the data is appended to the URL specified above.</p> |
| Use HTTP POST method for data portion | <p>If using the POST method, check this option.</p> <p>The data specified above is used as the content of the POST request.</p> |
| HTTP POST data content type | <p>If using the POST method, specify the content type such as "plain/text" or "application/xml".</p> |
| HTTPS Username
HTTPS Password
HTTPS Host name
HTTPS Port number | <p>Enter this information.</p> |

Related Topics

[SMS Providers and Services](#), on page 451

[Configure SMS Gateways to Send SMS Notifications to Guests](#), on page 451

DHCP and DNS Services

Use these settings to configure a DHCP, and optionally DNS, to enable Auth VLAN URL redirect simulation. You can create multiple scopes in order to apply them to different ISE nodes. If you apply multiple scopes to one ISE node, they should be configured on the same network interface.



Note For Profiling, you may need a DHCP probe. ISE DHCP probe uses the same UDP port 67 as the Auth VLAN DHCP service. Therefore the DHCP probe should be configured on a different interface or can be disabled on this ISE node. For more information about DHCP probes, see [DHCP Probe, on page 637](#).

Table 102: DHCP & DNS Service Settings for Auth VLAN URL Redirect Simulation

| Field Name | Usage Guidelines |
|--------------------------------|--|
| Scope Name | Enter a name by which you can easily remember the purpose of this scope. |
| Status | Select Enabled or Disabled . The scope can only be used for an ISE node when enabled. |
| ISE Node | Apply an ISE node to act as the DHCP/DNS server. From the dropdown list, select the ISE node with which to use this scope. The Auth VLAN is defined per ISE node or network interface and no two interfaces or two nodes can share the same VLAN. |
| Network Interface | The network interfaces available for the ISE node that you selected appear in this dropdown list dynamically based on the ISE node that you selected. Select the interface from which the DHCP/DNS server listens. Multiple VLANs may be connected to one network interface card by configuring a VLAN IP-helper on the NAD. |
| Domain Name | Enter the domain name for the DHCP server to be used in this scope. |
| DHCP Address range | Based on your network definitions, select the range of DHCP addresses available to be used for this scope. |
| Subnet mask | Based on your network definitions, select the network mask to be used for this scope. |
| Network ID | Automatically determined by Cisco ISE based on the DHCP attributes you enter. |
| Exclusion address range | Based on your network definitions, select the range of DHCP addresses that should not be used for this scope. |
| Default gateway | Enter the IP address of the default gateway. |
| DHCP lease time | Define the the DHCP lease time. |

| Field Name | Usage Guidelines |
|-----------------------------|--|
| DHCP options | <p>(Optional) DHCP options are added configuration parameters that a DHCP server send to DHCP clients. DHCP options provide support for devices such as cameras, access points, or phones that require the information indicated in the option value to access the network, or as a method to bootstrap the device before final authorization. When the DHCP server receives the DHCP Request message from the client, the server (typically) responds by sending a DHCP ACK packet to the client. At this time, the server then forwards any configured options within the DHCP ACK packet.</p> <p>For more details, see the DHCP Options section below this table.</p> |
| External DNS servers | <p>If you would like users to be allowed access to external domains outside of the Auth VLAN before receiving authentication to access the entire corporate network, enter the IP addresses of the DNS servers to resolve the external DNS names.</p> |
| External Domains | <p>If you would like users to be allowed to access a specific site before receiving authentication to access the entire corporate network, enter the domain names of those sites in these fields.</p> <p>Enter the names of all the child domains that users may need access to, apart from the parent domain.</p> |

DHCP Options

When configuring a DHCP service in ISE, you can assign specific DHCP options for clients that connect to the Auth VLAN. You can add multiple DHCP options to each scope that you define.

The options available in the dropdown list are as taken from RFC 2132. You can also add additional customized options (from RFC 2132) by selecting **Custom** from the dropdown list and entering the option code.

In general, there are several DHCP options that tend to be used most frequently. Common options include:

- Option 12 (Hostname): used to carry the “hostname” portion of a node’s Fully Qualified Domain Name. For example, "mail" of mail.ise.com.
- Option 42 (NTP Servers): carries the NTP servers used on the network.
- Option 66 (TFTP Server): used to carry the IP address or hostname. This option is available in the dropdown list.
- Option 82 (DHCP Relay Agent): used to carry other sub options for server side dhcp relay server information.

To define the option value, select an option from the dropdown list. The code and type populate automatically if you select a pre-defined **Option**.

If you select **Custom**, enter the **Code** and **Value**. The **Type** field is updated automatically.

Figure 72: DHCP Options

*Domain name

*DHCP Address range to

*Subnet mask

*Network ID

Exclusion address range to

*Default gateway

*DHCP lease time seconds(5-300)

| Option | Code | Type | Value |
|------------------|------|--------|----------|
| DHCP options | | | |
| Custom | 12 | Text | mail |
| Class Identifier | 60 | String | pxelinux |

For example:

- To set a hostname: From the **Option** drop-down list, choose **Custom**. Enter the code in the **Code** field (for example, 15). The **Type** field is automatically populated as Text. Enter the hostname in the **Value** field.
- To set a TFTP Server Name: From the **Option** drop-down list, choose the TFTP server name. **Code** and **Type** fields are updated automatically. In the **Value** field, type the TFTP server hostname.



Note Some of the DHCP options can not be manually entered because they are automatically defined for ISE.

To enter multiple options click the plus sign under **Actions**.

Related Topics

[Third-Party Network Device Support in Cisco ISE](#), on page 217

[Configure a Third-Party Network Device in Cisco ISE](#), on page 221

[DHCP Probe](#), on page 637

Identity Management

These windows enable you to configure and manage identities in Cisco ISE.

Endpoints

These windows enable you to configure and manage endpoints that connect to your network.

Endpoint Settings

Table 103: Endpoint Settings

| Field Name | Usage Guidelines |
|--------------------------------|---|
| MAC Address | <p>Enter the MAC address in hexadecimal format to create an endpoint statically.</p> <p>The MAC address is the device identifier for the interface that is connected to the Cisco ISE enabled network.</p> |
| Static Assignment | <p>Check this check box when you want to create an endpoint statically in the Endpoints window and the status of static assignment is set to static.</p> <p>You can toggle the status of static assignment of an endpoint from static to dynamic or from dynamic to static.</p> |
| Policy Assignment | <p>(Disabled by default unless the Static Assignment is checked) Choose a matching endpoint policy from the Policy Assignment drop-down list.</p> <p>You can do one of the following:</p> <ul style="list-style-type: none"> • If you do not choose a matching endpoint policy, but use the default endpoint policy Unknown, then the static assignment status is set to dynamic for the endpoint that allows dynamic profiling of an endpoint. • If you choose a matching endpoint policy other than Unknown, then the static assignment status is set to static for that endpoint and the Static Assignment check box is automatically checked. |
| Static Group Assignment | <p>Check this check box when you want to assign an endpoint to an identity group statically.</p> <p>In you check this check box, the profiling service does not change the endpoint identity group the next time during evaluation of the endpoint policy for these endpoints, which were previously assigned dynamically to other endpoint identity groups.</p> <p>If you uncheck this check box, then the endpoint identity group is dynamic as assigned by the ISE profiler based on policy configuration. If you do not choose the Static Group Assignment option, then the endpoint is automatically assigned to the matching identity group the next time during evaluation of the endpoint policy.</p> |

| Field Name | Usage Guidelines |
|----------------------------------|---|
| Identity Group Assignment | <p>Choose an endpoint identity group to which you want to assign the endpoint.</p> <p>You can assign an endpoint to an identity group when you create an endpoint statically, or when you do not want to use the Create Matching Identity Group option during evaluation of the endpoint policy for an endpoint.</p> <p>Cisco ISE includes the following system created endpoint identity groups:</p> <ul style="list-style-type: none"> • Blacklist • GuestEndpoints • Profiled <ul style="list-style-type: none"> • Cisco IP-Phone • Workstation • RegisteredDevices • Unknown |

Related Topics

[Identified Endpoints](#), on page 685

[Create Endpoints with Static Assignments of Policies and Identity Groups](#), on page 681

Endpoint Import from LDAP Settings

Table 104: Endpoint Import from LDAP Settings

| Field Name | Usage Guidelines |
|---------------------------------|---|
| Connection Settings | |
| Host | Enter the hostname, or the IP address of the LDAP server. |
| Port | <p>Enter the port number of the LDAP server. You can use the default port 389 to import from an LDAP server, and the default port 636 to import from an LDAP server over SSL.</p> <p>Note Cisco ISE supports any configured port number. The configured value should match the LDAP server connection details.</p> |
| Enable Secure Connection | Check the Enable Secure Connection check box to import from an LDAP server over SSL. |

| Field Name | Usage Guidelines |
|-----------------------------------|--|
| Root CA Certificate Name | <p>Click the drop-down arrow to view the trusted CA certificates.</p> <p>The Root CA Certificate Name refers to the trusted CA certificate that is required to connect to an LDAP server. You can add (import), edit, delete, and export trusted CA certificates in Cisco ISE.</p> |
| Anonymous Bind | <p>You must enable either the Anonymous Bind check box, or enter the LDAP administrator credentials from the slapd.conf configuration file.</p> |
| Admin DN | <p>Enter the distinguished name (DN) configured for the LDAP administrator in the slapd.conf configuration file.</p> <p>Admin DN format example: cn=Admin, dc=cisco.com, dc=com</p> |
| Password | <p>Enter the password configured for the LDAP administrator in the slapd.conf configuration file.</p> |
| Base DN | <p>Enter the distinguished name of the parent entry.</p> <p>Base DN format example: dc=cisco.com, dc=com.</p> |
| Query Settings | |
| MAC Address objectClass | <p>Enter the query filter, which is used for importing the MAC address, for example, ieee802Device.</p> |
| MAC Address Attribute Name | <p>Enter the returned attribute name for import, for example, macAddress.</p> |

| Field Name | Usage Guidelines |
|-------------------------------|---|
| Profile Attribute Name | <p>Enter the name of the LDAP attribute. This attribute holds the policy name for each endpoint entry that is defined in the LDAP server.</p> <p>When you configure the Profile Attribute Name field, consider the following:</p> <ul style="list-style-type: none"> • If you do not specify this LDAP attribute in the Profile Attribute Name field or configure this attribute incorrectly, then endpoints are marked “Unknown” during an import operation, and these endpoints are profiled separately to the matching endpoint profiling policies. • If you configure this LDAP attribute in the Profile Attribute Name field, the attribute values are validated to ensure that the endpoint policy matches with an existing policy in Cisco ISE, and endpoints are imported. If the endpoint policy does not match with an existing policy, then those endpoints will not be imported. |
| Time Out | Enter the time in seconds. The valid range is from 1 to 60 seconds. |

Related Topics

[Identified Endpoints](#), on page 685

[Import Endpoints from LDAP Server](#), on page 684

Endpoint Identity Group Settings

Table 105: Endpoint Identity Group Settings

| Field Name | Usage Guidelines |
|---------------------|---|
| Name | Enter the name of the endpoint identity group that you want to create. |
| Description | Enter a description for the endpoint identity group that you want to create. |
| Parent Group | Choose an endpoint identity group from the Parent Group drop-down list to which you want to associate the newly created endpoint identity group. |

Related Topics

[Identified Endpoints Grouped in Endpoint Identity Groups](#), on page 688

[Create Endpoint Identity Groups](#), on page 687

External Identity Sources

These windows enable you to configure and manage external identity sources that contain user data that Cisco ISE uses for authentication and authorization.

LDAP Identity Source Settings

LDAP General Settings

The following table describes the fields in the **General** tab.

Table 106: LDAP General Settings

| Field Name | Usage Guidelines |
|-------------------------------|--|
| Name | Enter a name for the LDAP instance. This value is used in searches to obtain the subject DN and attributes. The value is of type string and the maximum length is 64 characters. |
| Description | Enter a description for the LDAP instance. This value is of type string, and has a maximum length of 1024 characters. |
| Schema | <p>You can choose any one of the following built-in schema types or create a custom schema:</p> <ul style="list-style-type: none"> • Active Directory • Sun Directory Server • Novell eDirectory <p>You can click the arrow next to Schema to view the schema details.</p> <p>If you edit the attributes of the predefined schema, Cisco ISE automatically creates a Custom schema.</p> |
| Note | The following fields can be edited only when you choose the Custom schema. |
| Subject Objectclass | Enter a value to be used in searches to obtain the subject DN and attributes. The value is of type string and the maximum length is 256 characters. |
| Subject Name Attribute | Enter the name of the attribute containing the username in the request. The value is of type string and the maximum length is 256 characters. |

| Field Name | Usage Guidelines |
|---|---|
| Group Name Attribute | <ul style="list-style-type: none"> • CN: To retrieve the LDAP Identity Store Groups based on Common Name. • DN: To retrieve the LDAP Identity Store Groups based on Distinguished Name. |
| Certificate Attribute | Enter the attribute that contains the certificate definitions. For certificate-based authentication, these definitions are used to validate certificates that are presented by clients. |
| Group Objectclass | Enter a value to be used in searches to specify the objects that are recognized as groups. The value is of type string and the maximum length is 256 characters. |
| Group Map Attribute | Specifies the attribute that contains the mapping information. This attribute can be a user or group attribute based on the reference direction that is chosen. |
| Subject Objects Contain Reference To Groups | Click this option if the subject objects contain an attribute that specifies the group to which they belong. |
| Group Objects Contain Reference To Subjects | Click this option if the group objects contain an attribute that specifies the subject. This value is the default value. |
| Subjects in Groups Are Stored in Member Attribute As | (Only available when you enable the Group Objects Contain Reference To Subjects option) Specifies how members are sourced in the group member attribute and defaults to the DN. |
| User Info Attributes | <p>By default, predefined attributes are used to collect user information (such as, first name, last name, email, telephone, locality, and so on) for the following built-in schema types:</p> <ul style="list-style-type: none"> • Active Directory • Sun Directory Server • Novell eDirectory <p>If you edit the attributes of the predefined schema, Cisco ISE automatically creates a Custom schema.</p> <p>You can also select the Custom option from the Schema drop-down list to edit the user information attributes based on your requirements.</p> |



Note The subject name attributes that are configured should be an indexed one in the external ID store.

LDAP Connection Settings

The following table describes the fields in the **Connection Settings** tab.

Table 107: LDAP Connection Settings

| Field Name | Usage Guidelines |
|---|---|
| Enable Secondary Server | Check this option to enable the secondary LDAP server to be used as a backup if the primary LDAP server fails. If you check this check box, you must enter configuration parameters for the secondary LDAP server. |
| Primary and Secondary Servers | |
| Hostname/IP | Enter the IP address or DNS name of the machine that is running the LDAP software. The hostname can contain from 1 to 256 characters or a valid IP address expressed as a string. The only valid characters for hostnames are alphanumeric characters (a to z, A to Z, 0 to 9), the dot (.), and the hyphen (-). |
| Port | Enter the TCP/IP port number on which the LDAP server is listening. Valid values are from 1 to 65,535. The default is 389, as stated in the LDAP specification. If you do not know the port number, you can find this information from the LDAP server administrator. |
| Specify server for each ISE node | Check this check box to configure primary and secondary LDAP server hostnames/IP and their ports for each PSN.

When this option is enabled, a table listing all the nodes in the deployment is displayed. You need to select the node and configure the primary and secondary LDAP server hostname/IP and their ports for the selected node. |

| Field Name | Usage Guidelines |
|-------------------------------|---|
| Access | <p>Anonymous Access: Click to ensure that searches on the LDAP directory occur anonymously. The server does not distinguish who the client is and will allow the client read access to any data that is configured as accessible to any unauthenticated client. In the absence of a specific policy permitting authentication information to be sent to a server, a client should use an anonymous connection.</p> <p>Authenticated Access: Click to ensure that searches on the LDAP directory occur with administrative credentials. If so, enter information for the Admin DN and Password fields.</p> |
| Admin DN | Enter the DN of the administrator. The Admin DN is the LDAP account that has permission to search all required users under the User Directory Subtree and to search groups. If the administrator specified does not have permission to see the group name attribute in searches, group mapping fails for users who are authenticated by that LDAP server. |
| Password | Enter the LDAP administrator account password. |
| Secure Authentication | Click to use SSL to encrypt communication between Cisco ISE and the primary LDAP server. Verify that the Port field contains the port number used for SSL on the LDAP server. If you enable this option, you must choose a root CA. |
| LDAP Server Root CA | Choose a trusted root certificate authority from the drop-down list to enable secure authentication with a certificate. |
| Server Timeout | Enter the number of seconds that Cisco ISE waits for a response from the primary LDAP server before determining that the connection or authentication with that server has failed. Valid values are 1 to 99. The default is 10. |
| Max. Admin Connections | Enter the maximum number of concurrent connections (greater than 0) with LDAP administrator account permissions that can run for a specific LDAP configuration. These connections are used to search the directory for users and groups under the User Directory Subtree and the Group Directory Subtree. Valid values are 1 to 99. The default is 20. |

| Field Name | Usage Guidelines |
|---|--|
| Force reconnect every N seconds | Check this check box and enter the desired value in the Seconds field to force the server to renew LDAP connection at the specified time interval. The valid range is from 1 to 60 minutes. |
| Test Bind to Server | Click to test and ensure that the LDAP server details and credentials can successfully bind. If the test fails, edit your LDAP server details and retest. |
| Failover | |
| Always Access Primary Server First | Click this option if you want Cisco ISE to always access the primary LDAP server first for authentications and authorizations. |
| Failback to Primary Server After | If the primary LDAP server that Cisco ISE attempts to contact cannot be reached, Cisco ISE attempts to contact the secondary LDAP server. If you want Cisco ISE to use the primary LDAP server again, click this option and enter a value in the text box. |

LDAP Directory Organization Settings

The following table describes the fields in the **Directory Organization** tab.

Table 108: LDAP Directory Organization Settings

| Field Name | Usage Guidelines |
|----------------------------|--|
| Subject Search Base | Enter the DN for the subtree that contains all subjects. For example:
o=corporation.com
If the tree containing subjects is the base DN, enter:
o=corporation.com
or
dc=corporation,dc=com
as applicable to your LDAP configuration. For more information, refer to your LDAP database documentation. |

| Field Name | Usage Guidelines |
|---|---|
| Group Search Base | <p>Enter the DN for the subtree that contains all groups. For example:</p> <p>ou=organizational unit, ou=next organizational unit, o=corporation.com</p> <p>If the tree containing groups is the base DN, type:</p> <p>o=corporation.com</p> <p>or</p> <p>dc=corporation,dc=com</p> <p>as applicable to your LDAP configuration. For more information, refer to your LDAP database documentation.</p> |
| Search for MAC Address in Format | <p>Enter a MAC Address format for Cisco ISE to use for search in the LDAP database. MAC addresses in internal identity sources are sourced in the format xx-xx-xx-xx-xx-xx. MAC addresses in LDAP databases can be sourced in different formats. However, when Cisco ISE receives a host lookup request, Cisco ISE converts the MAC address from the internal format to the format that is specified in this field.</p> <p>Use the drop-down list to enable searching for MAC addresses in a specific format, where <i><format></i> can be any one of the following:</p> <ul style="list-style-type: none"> • xxxx.xxxx.xxxx • xxxxxxxxxxxx • xx-xx-xx-xx-xx-xx • xx:xx:xx:xx:xx:xx <p>The format you choose must match the format of the MAC address sourced in the LDAP server.</p> |

| Field Name | Usage Guidelines |
|--|---|
| <p>Strip Start of Subject Name Up To the Last Occurrence of the Separator</p> | <p>Enter the appropriate text to remove domain prefixes from usernames.</p> <p>If Cisco ISE finds the delimiter character that is specified in this field in the username, it strips all characters from the beginning of the username through the delimiter character. If the username contains more than one of the characters that are specified in the <start_string> box, Cisco ISE strips characters through the last occurrence of the delimiter character. For example, if the delimiter character is the backslash (\) and the username is DOMAIN\user1, Cisco ISE submits user1 to an LDAP server.</p> <p>Note The <start_string> cannot contain the following special characters: the pound sign (#), the question mark (?), the quotation mark (“), the asterisk (*), the right angle bracket (>), and the left angle bracket (<). Cisco ISE does not allow these characters in usernames.</p> |
| <p>Strip End of Subject Name from the First Occurrence of the Separator</p> | <p>Enter the appropriate text to remove domain suffixes from usernames.</p> <p>If Cisco ISE finds the delimiter character that is specified in this field in the username, it strips all characters from the delimiter character through the end of the username. If the username contains more than one of the characters that are specified in this field, Cisco ISE strips characters starting with the first occurrence of the delimiter character. For example, if the delimiter character is @ and the username is <i>user1@domain</i>, then Cisco ISE submits <i>user1</i> to the LDAP server.</p> <p>Note The <end_string> box cannot contain the following special characters: the pound sign (#), the question mark (?), the quotation mark ("), the asterisk (*), the right angle bracket (>), and the left angle bracket (<). Cisco ISE does not allow these characters in usernames.</p> |

LDAP Group Settings

Table 109: LDAP Group Settings

| Field Name | Usage Guidelines |
|------------|---|
| Add | <p>Choose Add > Add Group to add a new group or choose Add > Select Groups From Directory to select the groups from the LDAP directory.</p> <p>If you choose to add a group, enter a name for the new group. If you are selecting from the directory, enter the filter criteria, and click Retrieve Groups. Check the check boxes next to the groups that you want to select and click OK. The groups that you have selected will appear in the Groups window.</p> |

LDAP Attribute Settings

Table 110: LDAP Attribute Settings

| Field Name | Usage Guidelines |
|------------|---|
| Add | <p>Choose Add > Add Attribute to add a new attribute or choose Add > Select Attributes From Directory to select attributes from the LDAP server.</p> <p>If you choose to add an attribute, enter a name for the new attribute. If you are selecting from the directory, enter the username and click Retrieve Attributes to retrieve the attributes. Check the check boxes next to the attributes that you want to select, and then click OK.</p> |

LDAP Advanced Settings

The following table describes the field in the Advanced Settings tab.

Table 111: LDAP Advanced Settings

| Field Name | Usage Guidelines |
|------------------------|---|
| Enable Password Change | <p>Check this check box to enable the user to change the password in case of password expiry or password reset while using PAP protocol for device admin and RADIUS EAP-GTC protocol for network access. User authentication fails for the unsupported protocols. This option also enables the user to change the password on their next login.</p> |

Related Topics

- [LDAP Directory Service](#), on page 409
- [LDAP User Authentication](#), on page 411
- [LDAP User Lookup](#), on page 414
- [Add LDAP Identity Sources](#), on page 414

RADIUS Token Identity Sources Settings

Related Topics

- [RADIUS Token Identity Sources](#), on page 423

[Add a RADIUS Token Server](#), on page 426

RSA SecurID Identity Source Settings

RSA Prompt Settings

The following table describes the fields in the **RSA Prompts** tab.

Table 112: RSA Prompt Settings

| Field Name | Usage Guidelines |
|-------------------------------|--|
| Enter Passcode Prompt | Enter a text string to obtain the passcode. |
| Enter Next Token Code | Enter a text string to request the next token. |
| Choose PIN Type | Enter a text string to request the PIN type. |
| Accept System PIN | Enter a text string to accept the system-generated PIN. |
| Enter Alphanumeric PIN | Enter a text string to request an alphanumeric PIN. |
| Enter Numeric PIN | Enter a text string to request a numeric PIN. |
| Re-enter PIN | Enter a text string to request the user to re-enter the PIN. |

RSA Message Settings

The following table describes the fields in the **RSA Messages** tab.

Table 113: RSA Messages Settings

| Field Name | Usage Guidelines |
|------------------------------------|--|
| Display System PIN Message | Enter a text string to label the system PIN message. |
| Display System PIN Reminder | Enter a text string to inform the user to remember the new PIN. |
| Must Enter Numeric Error | Enter a message that instructs users to enter only numbers for the PIN. |
| Must Enter Alpha Error | Enter a message that instructs users to enter only alphanumeric characters for PINs. |
| PIN Accepted Message | Enter a message that the users see when their PIN is accepted by the system. |
| PIN Rejected Message | Enter a message that the users see when the system rejects their PIN. |
| User Pins Differ Error | Enter a message that the users see when they enter an incorrect PIN. |

| Field Name | Usage Guidelines |
|------------------------------------|--|
| System PIN Accepted Message | Enter a message that the users see when the system accepts their PIN. |
| Bad Password Length Error | Enter a message that the users see when the PIN that they specify does not fall within the range specified in the PIN length policy. |

Related Topics

[RSA Identity Sources](#), on page 428

[Cisco ISE and RSA SecurID Server Integration](#), on page 428

[Add RSA Identity Sources](#), on page 430

Network Resources

Support for Session Aware Networking (SAnet)

Cisco ISE provides limited support for Session Aware Networking (SAnet). SAnet is a session management framework that runs on many Cisco switches. SAnet manages access sessions, including visibility, authentication, and authorization. SAnet uses a service template, which contains RADIUS authorization attributes. Cisco ISE includes a service template inside an authorization profile. Cisco ISE identifies service templates in an authorization profile using a flag that identifies the profile as “Service Template” compatible.

Cisco ISE authorization profiles contain RADIUS authorization attributes that are transformed into a list of attributes. SAnet service templates also contain of RADIUS authorization attributes, but those attributes are not transformed into a list.

For SAnet devices, Cisco ISE sends the name of the service template. The device downloads the content of the service template, unless it already has that content in a cache or statically defined configuration. Cisco ISE sends a CoA notification to the device when a service template changes RADIUS attributes.

Network Devices

The windows described in the following sections enable you to add and manage network devices in Cisco ISE.

Network Device Definition Settings

The following tables describe the fields in the **Network Devices** window, which you can use to configure a network access device in Cisco ISE. The navigation path for this page is **Administration > Network Resources > Network Devices**, and click **Add**.

Network Device Settings

The following table describes the fields in the **Network Device Settings** window.

Table 114: Network Device Settings

| Field Name | Description |
|------------------------------|---|
| Name | <p>Enter a name for the network device.</p> <p>You can provide a descriptive name to the network device, which is different from the hostname of the device. The device name is a logical identifier.</p> <p>Note If needed, the name of a device can be changed after it is configured.</p> |
| Description | Enter a description for the device. |
| IP Address or IP Mask | <p>Enter a single IP address and a subnet mask.</p> <p>The following are the guidelines to follow while defining the IP addresses and subnet masks:</p> <ul style="list-style-type: none"> • You can define a specific IP address or a range with a subnet mask. If device A has an IP address range defined, you can configure another device B with an individual address from the range that is defined in device A. • You can define IP address ranges in the last octet. You can use a hyphen (-) or use asterisk (*) as wildcard to specify a range of IP addresses. For example, 1.1.1.1-10 or 1.1.1.* • You cannot define two devices with the same specific IP addresses. • You cannot define two devices with the same IP range. The IP ranges must not overlap either partially or completely. |
| Device Profile | <p>Choose the vendor of the network device from the drop-down list.</p> <p>Use the tooltip next to the drop-down list to see the flows and services that the selected vendor's network devices support. The tooltip also displays the RADIUS Change of Authorization (CoA) port and type of URL redirect that is used by the device. These attributes are defined in the device type's network device profile.</p> |
| Model Name | <p>Choose the device model from the drop-down list.</p> <p>Use the model name as one of the parameters while checking for conditions in rule-based policies. This attribute is present in the device dictionary.</p> |

| Field Name | Description |
|-----------------------------|---|
| Software Version | Choose the version of the software running on the network device from the drop-down list.

You can use the software version as one of the parameters while checking for conditions in rule-based policies. This attribute is present in the device dictionary. |
| Network Device Group | In the Network Device Group area, choose the required values from the Location , , and Device Type drop-down lists.

If you do not specifically assign a device to a group, it becomes a part of the default device groups (root network device groups), which is All Locations by location and All Device Types by device type. |



Note While using a filter to choose and delete a Network Access Device (NAD) from your Cisco ISE deployment, clear your browser cache to ensure that only chosen NADs are deleted.

RADIUS Authentication Settings

The following table describes the fields in the **RADIUS Authentication Settings** area.

Table 115: RADIUS Authentication Settings

| Field Name | Usage Guidelines |
|----------------------------|---|
| RADIUS UDP Settings | |
| Protocol | Displays RADIUS as the selected protocol. |

| Field Name | Usage Guidelines |
|-----------------------------|--|
| Shared Secret | <p>Enter the shared secret for the network device.</p> <p>The shared secret is the key that you have configured on the network device using the radius-host command with the pac option.</p> <p>Note Shared secret length must be equal to or greater than the value configured in the Minimum RADIUS Shared Secret Length field in the Device Security Settings window (Administration > Network Resources > Network Devices > Device Security Settings).</p> <p>For the RADIUS server, best practice is to have 22 characters. For new installations and upgraded deployments, by default, this value is 4 characters. You can change this value on the Device Security Settings window.</p> |
| CoA Port | <p>Specify the port to be used for RADIUS CoA.</p> <p>The default CoA port for the device is defined in the network device profile.</p> <p>Note If you modify the CoA port specified in the Network Devices window (Administration > Network Resources > Network Devices) under RADIUS Authentication Settings, make sure that you specify the same CoA port for the corresponding profile in the Network Device Profile window (Administration > Network Resources > Network Device Profiles).</p> |
| RADIUS DTLS Settings | |
| DTLS Required | <p>If you enable this option, Cisco ISE processes only the DTLS requests from this device. If this option is disabled, Cisco ISE processes both UDP and DTLS requests from this device.</p> <p>RADIUS DTLS provides improved security for SSL tunnel establishment and RADIUS communication.</p> |
| Shared Secret | <p>Displays the shared secret that is used for RADIUS DTLS. This value is fixed and used to compute the Message Digest 5 (MD5) integrity checks.</p> |
| CoA Port | <p>Specify the port to be used for RADIUS DTLS CoA.</p> |

| Field Name | Usage Guidelines |
|--|--|
| Issuer CA of ISE Certificates for CoA | Select the Certificate Authority to be used for RADIUS DTLS CoA from the drop-down list. |
| General Settings | |
| Enable KeyWrap | <p>Check this check box only when this feature is supported on the network device. This option is used to increase the RADIUS security via an AES KeyWrap algorithm.</p> <p>Note When you run Cisco ISE in FIPS mode, you must enable KeyWrap on the network device.</p> |
| Key Encryption Key | (Only appears when you enable KeyWrap) Enter an encryption key that is used for session encryption (secrecy). |
| Message Authenticator Code Key | (Only appears when you enable KeyWrap) Enter the key that is used for keyed Hashed Message Authentication Code (HMAC) calculation over RADIUS messages. |
| Key Input Format | <p>Choose one of the following formats:</p> <ul style="list-style-type: none"> • ASCII: The Key Encryption Key must be 16 characters (bytes) long, and the Message Authenticator Code Key must be 20 characters (bytes) long. • Hexadecimal: The Key Encryption Key must be 32 bytes long, and the Message Authenticator Code Key must be 40 bytes long. <p>You can specify the key input format that you want to use to enter the Cisco ISE FIPS encryption key, so that it matches the configuration that is available on the wireless LAN controller. (The value that you specify must be the correct [full] length for the key, and shorter values are not permitted.)</p> |

TACACS Authentication Settings

Table 116: Fields in the TACACS Authentication Settings Area

| Field Name | Usage Guidelines |
|--|--|
| Shared Secret | A string of text that is assigned to a network device when TACACS+ protocol is enabled. The user must enter the text before the network device authenticates a username and password. The connection is rejected until the user supplies the shared secret. |
| Retired Shared Secret is Active | Displayed when the retirement period is active. |
| Retire | Retires an existing shared secret instead of ending it. When you click Retire , a dialog box is displayed. You can click either Yes or No . |
| Remaining Retired Period | (Available only if you click Yes in the Retire dialog box) Displays the default value specified in Work Centers > Device Administration > Settings > Connection Settings > Default Shared Secret Retirement Period . You can change the default value, if required.

The old shared secret will remain active for the specified number of days. |
| End | (Available only if you click Yes in the Retire dialog box) Ends the retirement period and terminates the old shared secret. |
| Enable Single Connect Mode | Check the Enable Single Connect Mode check box to use a single TCP connection for all TACACS communications with the network device. Click one of the following radio buttons: <ul style="list-style-type: none"> • Legacy Cisco Devices • TACACS Draft Compliance Single Connect Support <p>Note If you disable Single Connect Mode, Cisco ISE uses a new TCP connection for every TACACS request.</p> |

SNMP Settings

The following table describes the fields in the **SNMP Settings** section.

Table 117: Fields in the SNMP Settings Area

| Field Name | Usage Guidelines |
|--------------------------|--|
| SNMP Version | <p>Choose one of the following options from the SNMP Version drop-down list:</p> <ul style="list-style-type: none"> • 1: SNMPv1 does not support informs. • 2c • 3: SNMPv3 is the most secure model because it allows packet encryption when you choose Priv in the Security Level field. <p>Note If you have configured your network device with SNMPv3 parameters, you cannot generate the Network Device Session Status summary report that is provided by the monitoring service (Operations > Reports > Catalog > Network Device > Session Status Summary). You can generate this report successfully if your network device is configured with SNMPv1 or SNMPv2c parameters.</p> |
| SNMP RO Community | <p>(Applicable only for SNMP versions 1 and 2c) Enter the Read Only Community string that provides Cisco ISE with a particular type of access to the device.</p> <p>Note The caret (circumflex ^) symbol is not allowed.</p> |
| SNMP Username | <p>(Only for SNMP Version 3) Enter the SNMP username.</p> |
| Security Level | <p>(Only for SNMP Version 3) Choose one the following options from the Security Level drop-down list:</p> <ul style="list-style-type: none"> • Auth: Enables MD5 or Secure Hash Algorithm (SHA) packet authentication. • No Auth: No authentication and no privacy security level. • Priv: Enables Data Encryption Standard (DES) packet encryption. |

| Field Name | Usage Guidelines |
|-------------------------|---|
| Auth Protocol | <p>(Only for SNMP Version 3 when the security levels Auth or Priv are selected) Choose the authentication protocol that you want the network device to use from the Auth Protocol drop-down list.</p> <ul style="list-style-type: none"> • MD5 • SHA |
| Auth Password | <p>(Only for SNMP Version 3 when the Auth or Priv security levels are selected) Enter the authentication key. It must be at least eight characters in length.</p> <p>Click Show to display the authentication password that is already configured for the device.</p> <p>Note The caret (circumflex ^) symbol cannot be used.</p> |
| Privacy Protocol | <p>(Only for SNMP Version 3 when Priv security level is selected) Choose one of the following options from the Privacy Protocol drop-down list:</p> <ul style="list-style-type: none"> • DES • AES128 • AES192 • AES256 • 3DES |
| Privacy Password | <p>(Only for SNMP Version 3 when Priv security level is selected) Enter the privacy key.</p> <p>Click Show to display the privacy password that is already configured for the device.</p> <p>Note The caret (circumflex ^) symbol cannot be used.</p> |
| Polling Interval | Enter the polling interval, in seconds. The default value is 3600. |
| Link Trap Query | Check the Link Trap Query check box to receive and interpret linkup and linkdown notifications received through the SNMP trap. |
| Mac Trap Query | Check the Link Trap Query check box to receive and interpret MAC notifications received through the SNMP trap. |

| Field Name | Usage Guidelines |
|---|--|
| Originating Policy Services Node | Choose the Cisco ISE server to be used to poll for SNMP data, from the Originating Policy Services Node drop-down list. The default value for this field is Auto . Overwrite the setting by choosing a specific value from the drop-down list. |

Advanced TrustSec Settings

The following table describes the fields in the **Advanced TrustSec Settings** section.

Table 118: Fields in the Advanced TrustSec Settings Area

| Field Name | Usage Guidelines |
|--|--|
| Use Device ID for TrustSec Identification | Check the Use Device ID for TrustSec Identification check box if you want the device name to be listed as the device identifier in the Device ID field. |
| Device ID | You can use this field only if you have not checked the Use Device ID for TrustSec Identification check box. |
| Password | Enter the password that you have configured in the Cisco TrustSec device's CLI to authenticate the Cisco TrustSec device.

Click Show to display the password. |
| HTTP REST API Settings | |
| TrustSec Device Notification and Updates Settings | |
| Use Device ID for TrustSec Identification | Check the Use Device ID for TrustSec Identification check box if you want the device name to be listed as the device identifier in the Device ID field. |
| Device ID | You can use this field only if you have not checked the Use Device ID for TrustSec Identification check box. |
| Password | Enter the password that you have configured in the Cisco TrustSec device's CLI to authenticate the Cisco TrustSec device.

Click Show to display the password. |
| Download Environment Data Every <...> | Specify the time interval at which the device must download its environment data from Cisco ISE, by choosing the required values from the drop-down lists in this area. You can choose the time interval in seconds, minutes, hours, days, or weeks. The default value is one day. |

| Field Name | Usage Guidelines |
|--|---|
| Download Peer Authorization Policy Every <...> | Specify the time interval at which the device must download the peer authorization policy from Cisco ISE by choosing the required values from the drop-down lists in this area. You can specify the time interval in seconds, minutes, hours, days, or weeks. The default value is one day. |
| Reauthentication Every <...> | Specify the time interval at which the device reauthenticates itself against Cisco ISE after the initial authentication, by choosing the required values from the drop-down lists in this area. You can configure the time interval in seconds, minutes, hours, days, or weeks. For example, if you enter 1000 seconds, the device will authenticate itself against Cisco ISE every 1000 seconds. The default value is one day. |
| Download SGACL Lists Every <...> | Specify the time interval at which the device downloads SGACL lists from Cisco ISE, by choosing the required values from the drop-down lists in this area. You can configure the time interval in seconds, minutes, hours, days, or weeks. The default value is one day. |
| Other TrustSec Devices to Trust This Device (TrustSec Trusted) | Check the Other TrustSec Devices to Trust This Device check box to allow all the peer devices to trust this Cisco TrustSec device. If this check box is not checked, the peer devices do not trust this device, and all the packets that arrive from this device are colored or tagged accordingly. |
| Notify this device about TrustSec configuration changes | Check this check box if you want Cisco ISE to send TrustSec CoA notifications to this TrustSec device. |
| Device Configuration Deployment Settings | |
| Include this device when deploying Security Group Tag Mapping Updates | Check the Include this device when deploying Security Group Tag Mapping Updates check box if you want the Cisco TrustSec device to obtain the IP-SGT mappings using the device interface credentials. |
| EXEC Mode Username | Enter the username that you use to log in to the Cisco TrustSec device. |

| Field Name | Usage Guidelines |
|---|---|
| EXEC Mode Password | Enter the device password.
Click Show to view the password.

Note We recommend that you avoid the use of the % character in passwords, including in the EXEC modes and Enable mode passwords in order to avoid security vulnerabilities. |
| Enable Mode Password | (Optional) Enter the enable password that is used to edit the configuration of the Cisco TrustSec device in privileged EXEC mode.
Click Show to view the password. |
| Out Of Band (OOB) TrustSec PAC Display | |
| Issue Date | Displays the issuing date of the last Cisco TrustSec PAC that was generated by Cisco ISE for the Cisco TrustSec device. |
| Expiration Date | Displays the expiration date of the last Cisco TrustSec PAC that was generated by Cisco ISE for the Cisco TrustSec device. |
| Issued By | Displays the name of the issuer (a Cisco TrustSec administrator) of the last Cisco TrustSec PAC that was generated by Cisco ISE for the Cisco TrustSec device. |
| Generate PAC | Click the Generate PAC button to generate the out-of-band Cisco TrustSec PAC for the Cisco TrustSec device. |

Related Topics

- [Defining Network Devices in Cisco ISE](#), on page 213
- [Third-Party Network Device Support in Cisco ISE](#), on page 217
- [Network Device Groups](#), on page 224
- [Add a Network Device in Cisco ISE](#), on page 189
- [Configure a Third-Party Network Device in Cisco ISE](#), on page 221

Default Network Device Definition Settings

The following table describes the fields in the **Default Network Device** window, with which you configure a default network device that Cisco ISE can use for RADIUS or TACACS+ authentication. Choose one of the following navigation paths:

- **Administration > Network Resources > Network Devices > Default Device**
- **Work Centers > Device Administration > Network Resources > Default Devices**

Table 119: Fields in the Default Network Device Window

| Field Name | Usage Guidelines |
|---------------------------------------|--|
| Default Network Device Status | <p>Choose Enable from the Default Network Device Status drop-down list to enable the default network device definition.</p> <p>Note If the default device is enabled, you must enable either the RADIUS or the TACACS+ authentication settings by checking the relevant check box in the window.</p> |
| Device Profile | Displays Cisco as the default device vendor. |
| RADIUS Authentication Settings | |
| Enable RADIUS | Check the Enable RADIUS check box to enable RADIUS authentication for the device. |
| RADIUS UDP Settings | |
| Shared Secret | <p>Enter a shared secret. The shared secret can be up to 127 characters in length.</p> <p>The shared secret is the key that you have configured on the network device using the radius-host command with the pac keyword.</p> <p>Note The length of the shared secret must be equal to or greater than the value configured in the Minimum RADIUS Shared Secret Length field in the Device Security Settings window (Administration > Network Resources > Network Devices > Device Security Settings). By default, this value is four characters for new installations and upgraded deployments. For the RADIUS server, the best practice is to have 22 characters.</p> |
| RADIUS DTLS Settings | |
| DTLS Required | <p>If you check the DTLS Required check box, Cisco ISE processes only the DTLS requests from this device. If this option is disabled, Cisco ISE processes both UDP and DTLS requests from this device.</p> <p>RADIUS DTLS provides improved security for SSL tunnel establishment and RADIUS communication.</p> |

| Field Name | Usage Guidelines |
|--|---|
| Shared Secret | Displays the shared secret that is used for RADIUS DTLS. This value is fixed and is used to compute the MD5 integrity checks. |
| Issuer CA of ISE Certificates for CoA | Choose the certificate authority to be used for RADIUS DTLS CoA from the Issuer CA of ISE Certificates for CoA drop-down list. |
| General Settings | |
| Enable KeyWrap | (Optional) Check the Enable KeyWrap check box only if KeyWrap algorithms are supported on the network device, which increases RADIUS security through an AES KeyWrap algorithm. |
| Key Encryption Key | Enter an encryption key to be used for session encryption (secrecy) when you enable KeyWrap. |
| Message Authenticator Code Key | Enter the key that is used for keyed Hashed Message Authentication Code (HMAC) calculation over RADIUS messages when you enable KeyWrap. |
| Key Input Format | <p>Choose one of the following formats by clicking the corresponding radio button, and enter values in the Key Encryption Key and Message Authenticator Code Key fields:</p> <ul style="list-style-type: none"> • ASCII: The Key Encryption Key must be 16 characters (bytes) in length, and the Message Authenticator Code Key must be 20 characters (bytes) in length. • Hexadecimal: The Key Encryption Key must be 32 bytes in length, and the Message Authenticator Code Key must be 40 bytes in length. <p>Specify the key input format that you want to use to enter the Key Encryption Key and Message Authenticator Code Key so that it matches the configuration on the network device. The value that you specify must be the correct (full) length for the key. Shorter values are not permitted.</p> |
| TACACS Authentication Settings | |
| Shared Secret | Enter a string of text to assign to a network device when the TACACS+ protocol is enabled. Note that a user must enter the text before the network device authenticates a username and password. The connection is rejected until the user supplies the shared secret. |

| Field Name | Usage Guidelines |
|--|--|
| Retired Shared Secret is Active | Displayed when the retirement period is active. |
| Retire | Retires an existing shared secret instead of ending it. When you click Retire , a dialog box is displayed. Click Yes or No . |
| Remaining Retired Period | (Optional) Available only if you click Yes in the Retire dialog box. Displays the default value that is specified in the Work Centers > Device Administration > Settings > Connection Settings > Default Shared Secret Retirement Period window. You can change the default values.

This allows a new shared secret to be entered. The old shared secret remains active for the specified number of days. |
| End | (Optional) Available only if you select Yes in the Remaining Retired Period dialog box. Ends the retirement period and terminates the old shared secret. |
| Enable Single Connect Mode | Check the Enable Single Connect Mode check box to use a single TCP connection for all TACACS+ communication with the network device. Click one of the following the radio buttons: <ul style="list-style-type: none"> • Legacy Cisco Devices • TACACS Draft Compliance Single Connect Support. <p>Note If you disable this field, Cisco ISE uses a new TCP connection for every TACACS+ request.</p> |

Device Security Settings

Specify the minimum length for the RADIUS shared secret. For new installation and upgraded deployment, by default, this value is 4 characters. For the RADIUS server, best practice is to have 22 characters.



Note The length of the shared secret entered in the Network Devices page must be equal to or greater than the value configured in the Minimum RADIUS Shared Secret Length field in the Device Security Settings page.

Related Topics

[Network Device Definition Settings](#), on page 1022

Network Device Import Settings

Table 120: Import Network Devices Settings

| Field Name | Usage Guidelines |
|--|---|
| Generate a Template | <p>Click Generate a Template to create a comma-separated value (CSV) template file.</p> <p>Update the template with network devices information in the CSV format and save it locally. Then, use the edited template to import network devices into any Cisco ISE deployment.</p> |
| File | <p>Click Browse to choose the CSV file that you have recently created, or previously exported from a Cisco ISE deployment.</p> <p>You can import network devices into another Cisco ISE deployment with new and updated network devices information, by using the Import option.</p> |
| Overwrite Existing Data with New Data | <p>Check the Overwrite Existing Data with New Data check box to replace the existing network devices with the devices in your import file.</p> <p>If you do not check this check box, new network device definitions that are available in the import file are added to the network device repository. Duplicate entries are ignored.</p> |
| Stop Import on First Error | <p>Check the Stop Import on First Error check box if you want Cisco ISE to discontinue import when it encounters an error during import. Cisco ISE imports network devices until the time of an error.</p> <p>If this check box is not checked and an error is encountered, the error is reported and Cisco ISE continues to import the remaining devices.</p> |

Related Topics

[Defining Network Devices in Cisco ISE](#), on page 213

[Third-Party Network Device Support in Cisco ISE](#), on page 217

[Import Network Devices into Cisco ISE](#), on page 216

Manage Network Device Groups

The following windows enable you to configure and manage network device groups.

Network Device Group Settings

You can also create network device groups in the **Work Centers > Device Administration > Network Resources > Network Device Groups > All Groups** window.

Table 121: Fields in the Network Device Group Window

| Field Name | Usage Guidelines |
|------------------------|---|
| Name | <p>Enter a name for the root network device group. For all subsequent child network device groups added to this root network device group, enter the name of this newly created network device group.</p> <p>The full name of the network device group can have a maximum of 100 characters. For example, if you create a subgroup named India under the parent groups Global > Asia, then the full name of the network device group that you create would be Global > Asia > India. This full name cannot exceed 100 characters. If the full name of the network device group exceeds 100 characters, the network device group creation fails.</p> |
| Description | Enter a description for the root or the child network device group. |
| No. of Network Devices | The number of network devices in the network group is displayed in this column. |

Related Topics

[Network Device Groups](#), on page 224

[Network Device Attributes Used by Cisco ISE in Policy Evaluation](#), on page 225

[Add a Network Device in Cisco ISE](#), on page 189

Network Device Group Import Settings

Table 122: Fields in the Network Device Groups Import Window

| Field Name | Usage Guidelines |
|---------------------|---|
| Generate a Template | <p>Click this link to download a CSV template file.</p> <p>Update the template with network device group information in the same format, and save it locally to import the network device groups into any Cisco ISE deployment.</p> |
| File | <p>Click Browse and navigate to the location of the CSV file that you want to upload. This might be a newly created file or a file that was previously exported from another Cisco ISE deployment.</p> <p>You can import network device groups from one Cisco ISE deployment to another, with new and updated network device groups information.</p> |

| Field Name | Usage Guidelines |
|--|---|
| Overwrite Existing Data with New Data | <p>Check this check box if you want to replace existing network device groups with the device groups in your import file.</p> <p>If you do not check this check box, only new network device groups in the import file are added to the network device group repository. Duplicate entries are ignored.</p> |
| Stop Import on First Error | <p>Check this check box to discontinue import at the first instance of encountering an error during the import.</p> <p>If this check box is not checked and an error is encountered, Cisco ISE reports the error and continues importing the rest of the device groups.</p> |

Related Topics

[Network Device Groups](#), on page 224

[Network Device Attributes Used by Cisco ISE in Policy Evaluation](#), on page 225

[Import Network Device Groups into Cisco ISE](#), on page 226

Network Device Profiles Settings

The following table describes the fields on the Network Device Profiles window, which you can use to configure the default settings for a type of network device from a specific vendor, such as the device's support for protocols, redirect URLs, and CoA settings. You then use the profile to define specific network devices.

Network Device Profile Settings

The following table describes the fields in the Network Device Profile section.

Table 123: Network Device Profile Settings

| Field Name | Description |
|----------------------------|---|
| Name | Enter a name for the network device profile. |
| Description | Enter the description for the network device profile. |
| Icon | <p>Select the icon to use for the network device profile. This icon will default to the icon for the vendor that you select.</p> <p>The icon you select must be a 16 x 16 PNG file.</p> |
| Vendor | Select the vendor of the network device profile. |
| Supported Protocols | |
| RADIUS | Check this check box if this network device profile supports RADIUS. |

| Field Name | Description |
|----------------------------|---|
| TACACS+ | Check this check box if this network device profile supports TACACS+. |
| TrustSec | Check this check box if this network device profile supports TrustSec. |
| RADIUS Dictionaries | Select one or more RADIUS dictionaries supported by this profile. Import any vendor-specific RADIUS dictionaries before you create the profile. |

Authentication/Authorization Template Settings

The following table describes the fields in the Authentication/Authorization section.

Table 124: Authentication/Authorization Settings

| Field Name | Description |
|-----------------------------|---|
| Flow Type Conditions | <p>Cisco ISE supports 802.1X, MAC authentication bypass (MAB), and browser-based Web authentication login for basic user authentication and access via both wired and wireless networks.</p> <p>Check the check boxes for the authentication logins that this type of network device supports. It could be one or more of the following:</p> <ul style="list-style-type: none"> • Wired MAC authentication bypass (MAB) • Wireless MAB • Wired 802.1X • Wireless 802.1X • Wired Web Authentication • Wireless Web Authentication <p>After you check the authentication logins that the network device profile supports, specify the conditions for the login.</p> |
| Attribute Aliasing | Check the SSID check box to use the device's Service Set Identifier (SSID) as the friendly name in policy rules. This allows you to create a consistent name to use in policy rules. |
| Host Lookup (MAB) | |

| Field Name | Description |
|----------------------------|--|
| Process Host Lookup | <p>Check this check box to define the protocols for host lookup used by the network device profile.</p> <p>Network devices from different vendors perform MAB authentication differently. Depending on the device type, check the Check Password or Checking Calling-Station-Id equals MAC Address check box, or both, for the protocol you are using.</p> |
| Via PAP/ASCII | <p>Check this check box to configure Cisco ISE to detect a PAP request from the network device profile as a Host Lookup request.</p> |
| Via CHAP | <p>Check this check box to configure Cisco ISE to detect this type of request from the network devices as a Host Lookup request.</p> <p>This option enables CHAP authentication. CHAP uses a challenge-response mechanism with password encryption. CHAP does not work with Microsoft Active Directory.</p> |
| Via EAP-MD5 | <p>Check this check box to enable EAP-based MD5 hashed authentication for the network device profile.</p> |

Permissions

You can define the VLAN and ACL permissions that will be used for this network device profile. After the profile is saved, Cisco ISE automatically generates authorization profiles for each configured permission.

Table 125: Permissions

| Field Name | Description |
|-----------------|---|
| Set VLAN | <p>Check this check box to set the VLAN permissions for this network device profile. Choose of the following options:</p> <ul style="list-style-type: none"> • IETF 802.1X Attributes. This is a set of default RADIUS attributes defined by the Internet Engineering Task Force. • Unique Attributes. You can specify multiple RADIUS attribute-value pairs. |
| Set ACL | <p>Check this check box to select the RADIUS attribute to set for the ACL on the network device profile.</p> |

Change of Authorization (CoA) Template Settings

This template defines how the CoA is sent to this type of network device. The following table describes the fields in the Change of Authorization (CoA) section.

Table 126: Change of Authorization (CoA) Settings

| Field Name | Definition |
|-------------------------|--|
| CoA by | Select one of the following options: <ul style="list-style-type: none"> • RADIUS • SNMP • Not supported |
| CoA by RADIUS | |
| Default CoA Port | The port to send the RADIUS CoA. By default, this is port 1700 for Cisco devices and port 3799 for devices from a non-Cisco vendor.

You can override this on the Network Device window. |
| Timeout Interval | The number of seconds that Cisco ISE waits for a response after sending the CoA. |
| Retry Count | The number of times Cisco ISE attempts to send the CoA after the first timeout. |
| Disconnect | Select how to send a disconnect request to these devices. <ul style="list-style-type: none"> • RFC 5176: Check this check box for a standard session termination and leave the port ready for a new session, as defined per RFC 5176. • Port Bounce: Check this check box to terminate the session and restart the port. • Port Shutdown: Check this check box to terminate the session and shutdown the port. |
| Re-authenticate | Select how to send a reauthentication request to the network devices. This is currently supported only by Cisco devices. <ul style="list-style-type: none"> • Basic: Check this check box for a standard session reauthentication. • Rerun: Check this check box to run through the authentication method from the beginning. • Last: Use the last successful authentication method for the session. |

| Field Name | Definition |
|---------------------------|---|
| CoA Push | If the network devices do not support Cisco's TrustSec CoA feature, select this option to allow Cisco ISE to push a configuration change to the device. |
| CoA by SNMP | |
| Timeout Interval | The number of seconds that Cisco ISE waits for a response after sending the CoA. |
| Retry Count | The number of times that Cisco ISE attempts to send a CoA. |
| NAD Port Detection | Relevant RADIUS attribute is currently the only option. |
| Relevant RADIUS Attribute | Select how to detect the NAD port: <ul style="list-style-type: none"> • Nas-Port • Nas-Port-ID |
| Disconnect | Select how to send a disconnect request to these devices: <ul style="list-style-type: none"> • Reauthenticate: Check this check box to terminate the session and restart the port. • Port Bounce: Check this check box to terminate the session and restart the port. • Port Shutdown: Check this check box to terminate the session and shutdown the port. |

Redirect Template Settings

The network devices can redirect a client's HTTP requests if it's configured as part of the authorization profile. This template specifies whether this network device profile supports URL redirect. You will use the URL parameter names specific to the device type.

The following table describes the fields in the Redirect section.

Table 127: Redirect Settings

| Field Name | Definition |
|------------------------------|--|
| Type | Select whether the network device profile supports a static or dynamic URL redirect.

If your device supports neither, select Not Supported and set up a VLAN from Settings > DHCP & DNS Services . |
| Redirect URL Parameter Names | |

| Field Name | Definition |
|-------------------------------|--|
| Client IP Address | Enter the parameter name that the network devices use for a client's IP address. |
| Client MAC Address | Enter the parameter name that the network devices use for a client's MAC address. |
| Originating URL | Enter the parameter name that the network devices use for the originating URL. |
| Session ID | Enter the parameter name that the network devices use for the session ID. |
| SSID | Enter the parameter name that the network devices use for the Service Set Identifier (SSID). |
| Dynamic URL Parameters | |
| Parameter | When you select to use a Dynamic URL for redirection, you will need to specify how these network devices create the redirect URL. You can also specify whether the redirect URL uses the session ID or client MAC address. |

Advanced Settings

You can use the Network Device Profile to generate a number of policy elements to make it easy to use a network device in policy rules. These elements include compound conditions, authorization profiles, and allowed protocols.

Click **Generate Policy Elements** to create these elements.

Related Topics

[Network Device Profiles](#), on page 220

[Third-Party Network Device Support in Cisco ISE](#), on page 217

[Create a Network Device Profile](#), on page 222

External RADIUS Server Settings

Table 128: External RADIUS Server Settings

| Field Name | Usage Guidelines |
|--------------------|---|
| Name | Enter the name of the external RADIUS server. |
| Description | Enter a description of the external RADIUS server. |
| Host IP | Enter the IP address of the external RADIUS server. |

| Field Name | Usage Guidelines |
|---------------------------------------|--|
| Shared Secret | Enter the shared secret between Cisco ISE and the external RADIUS server that is used for authenticating the external RADIUS server. A shared secret is an expected string of text that a user must provide to enable the network device to authenticate a username and password. The connection is rejected until the user supplies the shared secret. The shared secret can be up to 128 characters in length. |
| Enable KeyWrap | Enable this option to increase the RADIUS protocol security via an AES KeyWrap algorithm, to help enable FIPS 140 compliance in Cisco ISE. |
| Key Encryption Key | (Only if you check the Enable Key Wrap check box)
Enter a key to be used for session encryption (secrecy). |
| Message Authenticator Code Key | (Only if you check the Enable Key Wrap check box)
Enter a key to be used for keyed HMAC calculation over RADIUS messages. |
| Key Input Format | Specify the format you want to use to enter the Cisco ISE encryption key, so that it matches the configuration that is available on the WLAN controller. The value you specify must be the correct (full) length for the key as defined below (shorter values are not permitted). <ul style="list-style-type: none"> • ASCII: The Key Encryption Key must be 16 characters (bytes) long, and the Message Authenticator Code Key must be 20 characters (bytes) long. • Hexadecimal: The Key Encryption Key must be 32 bytes long, and the Message Authenticator Code Key must be 40 bytes long. |
| Authentication Port | Enter the RADIUS authentication port number. The valid range is from 1 to 65535. The default is 1812. |
| Accounting Port | Enter the RADIUS accounting port number. The valid range is from 1 to 65535. The default is 1813. |
| Server Timeout | Enter the number of seconds that the Cisco ISE waits for a response from the external RADIUS server. The default is 5 seconds. Valid values are from 5 to 120. |
| Connection Attempts | Enter the number of times that the Cisco ISE attempts to connect to the external RADIUS server. The default is 3 attempts. Valid values are from 1 to 9. |

Related Topics

[Cisco ISE Acting as a RADIUS Proxy Server](#), on page 579

[Configure External RADIUS Servers](#), on page 580

RADIUS Server Sequences

Table 129: RADIUS Server Sequences

| Field Name | Usage Guidelines |
|--|--|
| Name | Enter the name of the RADIUS server sequence. |
| Description | Enter an optional description. |
| Host IP | Enter the IP address of the external RADIUS server. |
| User Selected Service Type | Choose the external RADIUS servers that you want to use as policy servers from the Available list box and move them to the Selected list box. |
| Remote Accounting | Check this check box to enable accounting in the remote policy server. |
| Local Accounting | Check this check box to enable accounting in Cisco ISE. |
| Advanced Attribute Settings | |
| Strip Start of Subject Name up to the First Occurrence of the Separator | Check this check box to strip the username from the prefix. For example, if the subject name is acme\userA and the separator is \, the username becomes userA. |
| Strip End of Subject Name from the Last Occurrence of the Separator | <p>Check this check box to strip the username from the suffix. For example, if the subject name is userA@abc.com and the separator is @, the username becomes userA.</p> <ul style="list-style-type: none"> You must enable the strip options to extract the username from NetBIOS or User Principle Name (UPN) format usernames (user@domain.com or /domain/user), because only usernames are passed to the RADIUS server for authenticating the user. If you activate both the \ and @ stripping functions, and you are using Cisco AnyConnect, Cisco ISE does not accurately trim the first \ from the string. However, each stripping function that is used individually, works as it is designed with Cisco AnyConnect. |

| Field Name | Usage Guidelines |
|---|--|
| Modify Attributes in the Request to the External RADIUS Server | <p>Check this check box to allow Cisco ISE to manipulate attributes that come from or go to the authenticated RADIUS server.</p> <p>The attribute manipulation operations include these:</p> <ul style="list-style-type: none"> • Add: Add additional attributes to the overall RADIUS request/response. • Update: Change the attribute value (fixed or static) or substitute an attribute by another attribute value (dynamic). • Remove: Remove an attribute or an attribute-value pair. • RemoveAny: Remove any occurrences of the attribute. |
| Continue to Authorization Policy | <p>Check this check box to divert the proxy flow to run the authorization policy for further decision making, based on identity store group and attribute retrieval. If you enable this option, attributes from the response of the external RADIUS server will be applicable for the authentication policy selection. Attributes that are already in the context will be updated with the appropriate value from the AAA server accept response attribute.</p> |
| Modify Attributes before send an Access-Accept | <p>Check this check box to modify the attribute just before sending a response back to the device.</p> |

Related Topics

[Cisco ISE Acting as a RADIUS Proxy Server](#), on page 579

[Define RADIUS Server Sequences](#), on page 580

NAC Manager Settings

Table 130: NAC Manager Settings

| Fields | Usage Guidelines |
|-------------|---|
| Name | Enter the name of the Cisco Access Manager (CAM). |
| Status | Click the Status check box to enable REST API communication from the Cisco ISE profiler that authenticates connectivity to the CAM. |
| Description | Enter the description of the CAM. |

| Fields | Usage Guidelines |
|------------|---|
| IP Address | <p>Enter the IP address of the CAM. Once you have created and saved a CAM in Cisco ISE, the IP address of the CAM cannot be edited.</p> <p>You cannot use 0.0.0.0 and 255.255.255.255, as they are excluded when validating the IP addresses of the CAMs in Cisco ISE, and so, they are not valid IP addresses that you can use in the IP Address field for the CAM.</p> <p>Note You can use the virtual service IP address that a pair of CAMs share in a high-availability configuration. This allows a failover support of CAMs in a high-availability configuration.</p> |
| Username | Enter the username of the CAM administrator that allows you to log on to the user interface of the CAM. |
| Password | Enter the password of the CAM administrator that allows you to log on to the user interface of the CAM. |

Device Portal Management

Configure Device Portal Settings

Global Settings for Device Portals

Choose **Work Centers > BYOD > Settings > Employee Registered Devices** or **Administration > Device Portal Management > Settings**.

You can configure the following general settings for the BYOD and My Devices portals:

- **Employee Registered Devices:** Enter the maximum number of devices that an employee can register in **Restrict employees to**. By default, this value is set to **5** devices.
- **Retry URL:** Enter a URL that can be used to redirect the device back to Cisco ISE in **Retry URL for onboarding**.

Once you configure these general settings, they apply to all BYOD and My Devices portals that you set up for your company.

Related Topics

[Limit the Number of Personal Devices Registered by Employees](#), on page 490

[Provide a URL to Reconnect with BYOD Registration](#), on page 491

[End-User Device Portals in a Distributed Environment](#), on page 483

Portal Identification Settings for Device Portals

The navigation path for this window is: **Administration > Device Portal Management > Blacklist Portal, Client Provisioning Portals, BYOD Portals, MDM Portals, or My Device Portals > Create, Edit or Duplicate > Portals Settings and Customization.**

- **Portal Name:** Enter a unique portal name to access this portal. Do not use this portal name for any other Sponsor, Guest, or nonguest portals, such as Blacklist, Bring Your Own Device (BYOD), Client Provisioning, Mobile Device Management (MDM), or My Devices portals.

This name appears in the authorization profile portal selection for redirection choices. It is applied to the list of portals for easy identification among other portals.

- **Description:** Optional.
- **Portal Test URL:** A system-generated URL displays as a link after you click **Save**. Use it to test the portal.

Click the link to open a new browser tab that displays the URL for this portal. Policy Services Node (PSN) with Policy Services must be turned on. If Policy Services are disabled, the PSN only displays the Admin portal.



Note The test portal does not support RADIUS sessions, so you won't see the entire portal flow for all portals. BYOD and Client Provisioning are examples of portals that depend on RADIUS sessions. For example, a redirect to an external URL will not work. If you have more than one PSN, Cisco ISE chooses the first active PSN.

- **Language File:** Each portal type supports 15 languages by default, which are available as individual properties files bundled together in a single zipped language file. Export or import the zipped language file to use with the portal. The zipped language file contains all the individual language files that you can use to display text for the portal.

The language file contains the mapping to the particular browser locale setting along with all of the string settings for the entire portal in that language. A single language file contains all the supported languages, so that it can easily be used for translation and localization purposes.

If you change the browser locale setting for one language, the change is applied to all the other end-user web portals. For example, if you change the French.properties browser locale from fr,fr-fr,fr-ca to fr,fr-fr in the Hotspot Guest portal, the changes also apply to the My Devices portal.

An alert icon displays when you customize any of the text on the **Portal Page Customizations** tab. The alert message reminds you that any changes made to one language while customizing the portal must also be added to all the supported languages properties files. You can manually dismiss the alert icon using the drop-down list option; or it is automatically dismissed after you import the updated zipped language file.

Related Topics

- [Create Authorization Policy Rules](#), on page 504
- [Create Authorization Profiles](#), on page 504
- [Personal Device Portals](#), on page 484

Portal Settings for the Blacklist Portal

The navigation path for this window is: **Administration > Device Portal Management > Blacklist Portal > Edit > Portal Behavior and Flow Settings > Portal Settings.**

Use these settings to specify values or define behavior that applies to the overall portal; not just to specific portal pages that display to the user (guests, sponsors, or employees as applicable).

- **HTTPS Port:** Enter a port value between 8000 to 8999; the default value is 8443 for all the default portals, except the Blacklist Portal, which is 8444. If you upgraded with port values outside this range, they are honored until you modify this window. If you modify this window, update the port setting to comply with this restriction.

If you assign ports used by a non-guest (such as My Devices) portal to a guest portal, an error message appears.

For posture assessments and remediation only, the Client Provisioning portal also uses ports 8905 and 8909. Otherwise, it uses the same ports assigned to the Guest portal.

Portals assigned to the same HTTPS port can use the same Gigabit Ethernet interface or another interface. If they use the same port and interface combination, they must use the same certificate group tag. For example:

- Valid combinations include, using the Sponsor portal as an example:
 - Sponsor portal: Port **8443**, Interface **0**, Certificate tag **A** and My Devices portal: Port **8443**, Interface **0**, Certificate group **A**.
 - Sponsor portal: Port **8443**, Interface **0**, Certificate group **A** and My Devices portal: Port **8445**, Interface **0**, Certificate group **B**.
 - Sponsor portal: Port **8444**, Interface **1**, Certificate group **A** and Blacklist portal: Port **8444**, Interface **0**, Certificate group **B**.
- Invalid combinations include:
 - Sponsor portal: Port **8443**, Interface **0**, Certificate group **A** and My Devices portal: **8443**, Interface **0**, Certificate group **B**.
 - Sponsor portal: Port **8444**, Interface **0**, Certificate tag **A** and Blacklist portal: Port **8444**, Interface **0**, Certificate group **A**.



Note We recommend that you use interface 0 for Guest services for best performance. You can either configure only interface 0 in the **Portal Settings**, or you can use the CLI command **ip host** to map a hostname or FQDN to the IP address of interface 0.

- **Allowed Interfaces:** Select the PSN interfaces which a PAN can use to run a portal. When a request to open a portal is made on the PAN, the PAN looks for an available allowed port on the PSN. You must configure the Ethernet interfaces using IP addresses on different subnets.

These interfaces must be available on all the PSNs, including VM-based ones, that have Policy Services turned on. This is a requirement because any of these PSNs can be used for the redirect at the start of the guest session.

- The Ethernet interfaces must use IP addresses on different subnets.
- The interfaces you enable here must be available on all your PSNs, including VM-based ones when Policy Services turned on. This is required because any of these PSNs can be used for a redirect at the start of the guest session.
- The portal certificate Subject Name or Alternate Subject Name must resolve to the interface IP address.
- Configure **ip host x.x.x.x yyy.domain.com** in Cisco ISE CLI to map the secondary interface IP address to the FQDN, which is used to match the certificate Subject Name or Alternate Subject Name.
- If only the bonded NIC is selected, when the PSN attempts to configure the portal it first attempts to configure the Bond interface. If that is not successful, perhaps because there was no bond setup on that PSN, then the PSN logs an error and exits. The PSN will not try to start the portal on the physical interface.
- NIC Teaming or bonding is a configuration option that allows you to configure two individual NICs for high availability (fault tolerance). If one of the NICs fails, the other NIC that is part of the bonded connection continues the connection. A NIC is selected for a portal based in the **Portal Settings** configuration. If both physical NICs and the corresponding bonded NIC are configured, when the PSN attempts to configure the portal, it first attempts to connect to the Bond interface. If that is not successful, perhaps because there was no bond setup on that PSN, then the PSN attempts to start the portal on the physical interface.
- **Certificate Group tag:** Pick a certificate group tag that specifies the certificate to be used for the portal's HTTPS traffic.
- **Display Language**
 - **Use Browser Locale:** Use the language specified in the client browser's locale setting as the display language of the portal. If browser locale's language is not supported by Cisco ISE, then the **Fallback Language** is used as the language portal.
 - **Fallback Language:** Choose the language to use when the language cannot be obtained from the browser locale, or if the browser locale language is not supported by Cisco ISE.
 - **Always Use:** Choose the display language to use for the portal. This setting overrides the **User Browser Locale** option.

Related Topics

[Edit the Blacklist Portal](#), on page 495

[Blacklist Portal](#), on page 485

[HTML Support for the Blacklist Portal Language File](#), on page 1070

Portal Settings for BYOD and MDM Portals

Configure these settings to define portal page operations.

- **HTTPS Port:** Enter a port value between 8000 to 8999; the default value is 8443 for all the default portals, except the Blacklist Portal, which is 8444. If you upgraded with port values outside this range, they are honored until you modify this window. If you modify this window, update the port setting to comply with this restriction.

If you assign ports used by a non-guest (such as My Devices) portal to a guest portal, an error message appears.

For posture assessments and remediation only, the Client Provisioning portal also uses ports 8905 and 8909. Otherwise, it uses the same ports assigned to the Guest portal.

Portals assigned to the same HTTPS port can use the same Gigabit Ethernet interface or another interface. If they use the same port and interface combination, they must use the same certificate group tag. For example:

- Valid combinations include, using the Sponsor portal as an example:
 - Sponsor portal: Port **8443**, Interface **0**, Certificate tag **A** and My Devices portal: Port **8443**, Interface **0**, Certificate group **A**.
 - Sponsor portal: Port **8443**, Interface **0**, Certificate group **A** and My Devices portal: Port **8445**, Interface **0**, Certificate group **B**.
 - Sponsor portal: Port **8444**, Interface **1**, Certificate group **A** and Blacklist portal: Port **8444**, Interface **0**, Certificate group **B**.
- Invalid combinations include:
 - Sponsor portal: Port **8443**, Interface **0**, Certificate group **A** and My Devices portal: **8443**, Interface **0**, Certificate group **B**.
 - Sponsor portal: Port **8444**, Interface **0**, Certificate tag **A** and Blacklist portal: Port **8444**, Interface **0**, Certificate group **A**.



Note We recommend that you use interface 0 for Guest services for best performance. You can either configure only interface 0 in the **Portal Settings**, or you can use the CLI command **ip host** to map a hostname or FQDN to the IP address of interface 0.

- **Allowed Interfaces:** Select the PSN interfaces which a PAN can use to run a portal. When a request to open a portal is made on the PAN, the PAN looks for an available allowed port on the PSN. You must configure the Ethernet interfaces using IP addresses on different subnets.

These interfaces must be available on all the PSNs, including VM-based ones, that have Policy Services turned on. This is a requirement because any of these PSNs can be used for the redirect at the start of the guest session.

- The Ethernet interfaces must use IP addresses on different subnets.
- The interfaces you enable here must be available on all your PSNs, including VM-based ones when Policy Services turned on. This is required because any of these PSNs can be used for a redirect at the start of the guest session.
- The portal certificate Subject Name or Alternate Subject Name must resolve to the interface IP address.
- Configure **ip host x.x.x.x yyy.domain.com** in Cisco ISE CLI to map the secondary interface IP address to the FQDN, which is used to match the certificate Subject Name or Alternate Subject Name.

- If only the bonded NIC is selected, when the PSN attempts to configure the portal it first attempts to configure the Bond interface. If that is not successful, perhaps because there was no bond setup on that PSN, then the PSN logs an error and exits. The PSN will not try to start the portal on the physical interface.
- NIC Teaming or bonding is a configuration option that allows you to configure two individual NICs for high availability (fault tolerance). If one of the NICs fails, the other NIC that is part of the bonded connection continues the connection. A NIC is selected for a portal based in the **Portal Settings** configuration. If both physical NICs and the corresponding bonded NIC are configured, when the PSN attempts to configure the portal, it first attempts to connect to the Bond interface. If that is not successful, perhaps because there was no bond setup on that PSN, then the PSN attempts to start the portal on the physical interface.

- **Certificate Group tag:** Pick a certificate group tag that specifies the certificate to be used for the portal's HTTPS traffic.

- **Endpoint Identity Group:** Choose an endpoint identity group to track guest devices. Cisco ISE provides the **GuestEndpoints** endpoint identity group to use as a default. You can also create more endpoint identity groups if you choose to not use the default.

Choose an endpoint identity group to track employee devices. Cisco ISE provides the **RegisteredDevices** endpoint identity group to use as a default. You can also create more endpoint identity groups if you choose to not use the default.

- **Display Language**

- **Use Browser Locale:** Use the language specified in the client browser's locale setting as the display language of the portal. If browser locale's language is not supported by Cisco ISE, then the **Fallback Language** is used as the language portal.

- **Fallback Language:** Choose the language to use when the language cannot be obtained from the browser locale, or if the browser locale language is not supported by Cisco ISE.

- **Always Use:** Choose the display language to use for the portal. This setting overrides the **User Browser Locale** option.

Related Topics

[Bring Your Own Device Portal](#), on page 485

[Create a BYOD Portal](#), on page 497

[Mobile Device Management Portal](#), on page 486

[Create an MDM Portal](#), on page 501

[HTML Support for Bring Your Own Device Portals Language Files](#), on page 1071

[HTML Support for Mobile Device Management Portals Language Files](#), on page 1077

BYOD Settings for BYOD Portals

| Field Name | Usage Guidelines |
|---|---|
| Include an AUP (on page/as link) | Display your company's network-usage terms and conditions, either as text on the window currently being displayed for the user or as a link that opens a new tab or window with AUP text. |

| Field Name | Usage Guidelines |
|--|--|
| Require Acceptance | Require users to accept an AUP before their account is fully enabled. The Login button is not enabled unless the user accepts the AUP. If users do not accept the AUP, they will not obtain network access. |
| Require scrolling to end of AUP | This option displays only if Include an AUP on page is enabled.
Ensure that the user has read the AUP completely. The Accept button is enabled only after the user has scrolled to the end of the AUP. |
| Display Device ID Field During Registration | Display the device ID to the user during the registration process, even though the device ID is pre-configured and cannot be changed while using the BYOD portal. |
| Originating URL | After successfully authenticating to the network, redirect the user's browser to the original website that the user is trying to access, if available. If not available, the Authentication Success window appears. Make sure that the redirect URL is allowed to work on port 8443 of the PSN by the access-control list on the NAD and by authorization profiles configured in Cisco ISE for that NAD.

For Windows, MAC, and Android devices, control is given to the Self-Provisioning Wizard app, which does provisioning. Therefore, these devices are not redirected to the originating URL. However, iOS (dot1X) and unsupported devices (that are allowed network access) are redirected to this URL. |
| Success page | Display a page indicating that the device registration was successful. |
| URL | After successfully authenticating to the network, redirect the user's browser to the specified URL, such as your company's website. |



Note If you redirect a Guest to an external URL after authentication, there may be a delay while the URL address is resolved and the session is redirected.

Related Topics

[Bring Your Own Device Portal](#), on page 485

[Create a BYOD Portal](#), on page 497

[HTML Support for Bring Your Own Device Portals Language Files](#), on page 1071

Portal Settings for Certificate Provisioning Portal

- **HTTPS Port:** Enter a port value between 8000 to 8999; the default value is 8443 for all the default portals, except the Blacklist Portal, which is 8444. If you upgraded with port values outside this range, they are honored until you modify this window. If you modify this window, update the port setting to comply with this restriction.

If you assign ports used by a non-guest (such as My Devices) portal to a guest portal, an error message appears.

For posture assessments and remediation only, the Client Provisioning portal also uses ports 8905 and 8909. Otherwise, it uses the same ports assigned to the Guest portal.

Portals assigned to the same HTTPS port can use the same Gigabit Ethernet interface or another interface. If they use the same port and interface combination, they must use the same certificate group tag. For example:

- Valid combinations include, using the Sponsor portal as an example:
 - Sponsor portal: Port **8443**, Interface **0**, Certificate tag **A** and My Devices portal: Port **8443**, Interface **0**, Certificate group **A**.
 - Sponsor portal: Port **8443**, Interface **0**, Certificate group **A** and My Devices portal: Port **8445**, Interface **0**, Certificate group **B**.
 - Sponsor portal: Port **8444**, Interface **1**, Certificate group **A** and Blacklist portal: Port **8444**, Interface **0**, Certificate group **B**.
- Invalid combinations include:
 - Sponsor portal: Port **8443**, Interface **0**, Certificate group **A** and My Devices portal: **8443**, Interface **0**, Certificate group **B**.
 - Sponsor portal: Port **8444**, Interface **0**, Certificate tag **A** and Blacklist portal: Port **8444**, Interface **0**, Certificate group **A**.



Note We recommend that you use interface 0 for Guest services for best performance. You can either configure only interface 0 in the **Portal Settings**, or you can use the CLI command **ip host** to map a hostname or FQDN to the IP address of interface 0.

- **Allowed Interfaces:** Select the PSN interfaces which a PAN can use to run a portal. When a request to open a portal is made on the PAN, the PAN looks for an available allowed port on the PSN. You must configure the Ethernet interfaces using IP addresses on different subnets.

These interfaces must be available on all the PSNs, including VM-based ones, that have Policy Services turned on. This is a requirement because any of these PSNs can be used for the redirect at the start of the guest session.

- The Ethernet interfaces must use IP addresses on different subnets.
- The interfaces you enable here must be available on all your PSNs, including VM-based ones when Policy Services turned on. This is required because any of these PSNs can be used for a redirect at the start of the guest session.
- The portal certificate Subject Name or Alternate Subject Name must resolve to the interface IP address.
- Configure **ip host x.x.x.x yyy.domain.com** in Cisco ISE CLI to map the secondary interface IP address to the FQDN, which is used to match the certificate Subject Name or Alternate Subject Name.
- If only the bonded NIC is selected, when the PSN attempts to configure the portal it first attempts to configure the Bond interface. If that is not successful, perhaps because there was no bond setup

on that PSN, then the PSN logs an error and exits. The PSN will not try to start the portal on the physical interface.

- **NIC Teaming or bonding** is a configuration option that allows you to configure two individual NICs for high availability (fault tolerance). If one of the NICs fails, the other NIC that is part of the bonded connection continues the connection. A NIC is selected for a portal based in the **Portal Settings** configuration. If both physical NICs and the corresponding bonded NIC are configured, when the PSN attempts to configure the portal, it first attempts to connect to the Bond interface. If that is not successful, perhaps because there was no bond setup on that PSN, then the PSN attempts to start the portal on the physical interface.

- **Certificate Group tag:** Pick a certificate group tag that specifies the certificate to be used for the portal's HTTPS traffic.
- **Authentication Method:** Choose which identity source sequence or Identity Provider (IdP) to use for user authentication. The identity source sequence is a list of identity stores that are searched in sequence to verify user credentials.

Cisco ISE includes a default identity source sequence for sponsor portals, Sponsor_Portal_Sequence.

To configure IdP, choose **Administration > Identity Management > External Identity Sources > SAML Id Providers**.

To configure an identity source sequence, choose **Administration > Identity Management > Identity Source Sequences**.

- **Configure authorized groups:** Choose the user identity groups to which you want to grant permission to generate certificates and move them to the Chosen box.
- **Fully Qualified Domain Name (FQDN):** Enter at least one unique FQDN or hostname for the Sponsor or MyDevices portal. For example, you can enter **sponsorportal.yourcompany.com, sponsor**, so that when the user enters either of those into a browser, the sponsor portal displays. Separate names with commas, but do not include spaces between entries.

If you change the default FQDN, then also do the following:

- Update your DNS so that the FQDN of the new URL resolves to a valid Policy Services Node (PSN) IP address. Optionally, this address could point to a load balancer virtual IP address that serves a pool of PSNs.
- To avoid certificate warning messages due to name mismatches, include the FQDN of the customized URL, or a wildcard, in the subject alternative name (SAN) attribute of the local server certificate of the Cisco ISE PSN.

- **Idle Timeout:** Enter the time in minutes that you want Cisco ISE to wait before it logs out the user if there is no activity in the portal. The valid range is from 1 to 30 minutes.

Login Page Settings

- **Maximum Failed Login Attempts Before Rate Limiting:** Specify the number of failed login attempts from a single browser session before Cisco ISE starts to throttle that account. This does not cause an account lockout. The throttled rate is configured in **Time between login attempts when rate limiting**.
- **Include an AUP:** Add a acceptable use policy window to the flow. You can add the AUP to the window, or link to another window.

Acceptable Use Policy (AUP) Page Settings

- **Include an AUP Page:** Display your company's network-usage terms and conditions on a separate page to the user.
- **Use Different AUP for Employees:** Display a different AUP and network-usage terms and conditions for employees only. If you choose this option, you cannot also choose **Skip AUP for employees**.
- **Skip AUP for Employees:** Employees are not required to accept an AUP before accessing the network. If you choose this option, you cannot also choose **Use different AUP for employees**.
- **Require Acceptance:** Require users to accept an AUP before their account is fully enabled. The **Login** button is not enabled unless the user accepts the AUP. If users do not accept the AUP, they will not obtain network access.
- **Require Scrolling to End of AUP:** This option displays only if **Include an AUP on page** is enabled.

Ensure that the user has read the AUP completely. The **Accept** button activates only after the user has scrolled to the end of the AUP. Configure when the AUP appears to the user.

- **On First Login only:** Display an AUP the first time the user logs into the network or portal.
- **On Every Login:** Display an AUP every time the user logs into the network or portal.
- **Every __ Days (starting at first login):** Display an AUP periodically after the user first logs into the network or portal.

Related Topics

[Certificate Provisioning Portal](#), on page 485

[Create a Certificate Provisioning Portal](#), on page 499

[HTML Support for Certificate Provisioning Portal Language Files](#), on page 1072

Portal Settings for Client Provisioning Portals

Portal Settings

- **HTTPS Port:** Enter a port value between 8000 to 8999; the default value is 8443 for all the default portals, except the **Blacklist** Portal, which is 8444. If you upgraded with port values outside this range, they are honored until you make any change to this page. If you make any change to this page, you must update the port setting to comply with this restriction.
- **Allowed Interfaces:** Select the PSN interfaces which can run a portal. Only a PSN with an available allowed interface on a PSN can create a portal. You can configure any combination of physical and bonded interfaces. This is a PSN-wide configuration; all portals can only run on these interfaces, this interface configuration is pushed to all the PSNs.
 - You must configure the Ethernet interfaces using IP addresses on different subnets.
 - The interfaces you enable here must be available on all your PSNs, including VM-based ones when Policy Services turned on. This is required because any of these PSNs can be used for a redirect at the start of the guest session.
 - The portal certificate Subject Name/Alternate Subject Name must resolve to the interface IP.
 - Configure ip host x.x.x.x yyy.domain.com in ISE CLI to map secondary interface IP to FQDN, which will be used to match Certificate Subject Name/Alternate Subject Name.

- If only the bonded NIC is selected, when the PSN attempts to configure the portal it first attempts to configure the Bond interface. If that is not successful, perhaps because there was no bond set upon that PSN, then the PSN logs an error and exits. It will NOT attempt to start the portal on the physical interface.
- **NIC Teaming** or bonding is an O/S configuration option that allows you to configure two individual NICs for high availability (fault tolerance). If one of the NICs fails, the other NIC that is part of the bonded connection continues the connection. A NIC is selected for a portal based on the portal settings configuration:
 - If both physical NICs and the corresponding bonded NIC are configured - When the PSN attempts to configure the portal, it first attempts to connect to the Bond interface. If that is not successful, perhaps because there was no bond setup on that PSN, then the PSN attempts to start the portal on the physical interface.
- **Certificate Group Tag:** Select the group tag of the certificate group to use for the portal's HTTPS traffic.
- **Authentication Method:** Choose which identity source sequence (ISS) or Identity Provider (IdP) to use for user authentication. The ISS is a list of Identity Stores that are searched in sequence to verify user credentials. Some examples include: Internal Guest Users, Internal Users, Active Directory, and LDAP. Cisco ISE includes a default client provisioning Identity Source Sequence for Client Provisioning Portals, `Certificate_Request_Sequence`.
- **Fully Qualified Domain Name (FQDN):** Enter at least one unique FQDN and/or hostname for your Client Provisioning portal. For example, you can enter `provisionportal.yourcompany.com`, so that when the user enters either of those into a browser, they will reach the Client Provisioning Portal.
 - Update DNS to ensure that the FQDN of the new URL resolves to a valid Policy Services Node (PSN) IP address. Optionally, this address could point to a load balancer virtual IP address that serves a pool of PSNs.
 - To avoid certificate warning messages due to name mismatches, include the FQDN of the customized URL, or a wildcard, in the subject alternative name (SAN) attribute of the local server certificate of the Cisco ISE PSN.



Note For Client Provisioning without URL redirection, the portal name that is entered in the Fully Qualified Domain Name (FQDN) field must be configured in the DNS configuration. This URL must be communicated to the users to enable Client Provisioning without URL redirection.

- **Idle Timeout:** Enter the time in minutes that you want Cisco ISE to wait before it logs out the user if there is no activity in the portal. The valid range is from 1 to 30 minutes.



Note In the Client Provisioning Portal, you can define the port number and the certificate so that the host allows you to download the same certificate for Client Provisioning and Posture. If the portal certificate is signed by the official certificate authority, you will not receive any security warning. If the certificate is self-signed, you will receive one security warning for both the portals and Cisco AnyConnect Posture component.

Login Page Settings

- **Enable Login:** Select this check box to enable the login step in the Client Provisioning Portal
- **Maximum failed login attempts before rate limiting:** Specify the number of failed login attempts from a single browser session before Cisco ISE starts to artificially slow down the rate at which login attempts can be made, preventing additional login attempts. The time between attempts after this number of failed logins is reached is specified in **Time between login attempts when rate limiting**.
- **Time between login attempts when rate limiting:** Set the length of time in minutes that a user must wait before attempting to log in again, after failing to log in the number of times defined in **Maximum failed login attempts before rate limiting**.
- **Include an AUP (on page/as link):** Display your company's network-usage terms and conditions, either as text on the page currently being displayed for the user or as a link that opens a new tab or window with AUP text.
- **Require acceptance:** Require users to accept an AUP before they can access the portal. The **Login** button is not enabled unless the user accepts the AUP. If users do not accept the AUP, they will not be able to access the portal.
- **Require scrolling to end of AUP:** This option displays only if **Include an AUP on page** is enabled. Ensure that the user has read the AUP completely. The **Accept** button activates only after the user has scrolled to the end of the AUP.

Acceptable Use Policy (AUP) Page Settings

- **Include an AUP:** Display your company's network-usage terms and conditions on a separate page to the user.
- **Require scrolling to end of AUP:** Ensure that the user has read the AUP completely. The **Accept** button activates only after the user has scrolled to the end of the AUP.
- **On first login only:** Display an AUP when the user logs into the network or portal for the first time only.
- **On every login:** Display an AUP each time the user logs into the network or portal.
- **Every _____ days (starting at first login):** Display an AUP periodically after the user first logs into the network or portal.

Post-Login Banner Page Settings

Include a Post-Login Banner page: Display additional information after the users successfully log in and before they are granted network access.

Change Password Settings

Allow internal users to change their own passwords: Allow employees to change their passwords after they log in to the Client Provisioning Portal. This only applies to employees whose accounts are stored in the Cisco ISE database and not to those stored in external databases, such as Active Directory or LDAP.

Related Topics

[HTML Support for Client Provisioning Portal Language Files](#), on page 1073

Employee Mobile Device Management Settings for MDM Portals

| Field Name | Usage Guidelines |
|---|--|
| Include an AUP (on page/as link) | Display your company's network-usage terms and conditions, either as text on the window currently being displayed for the user or as a link that opens a new tab or window with AUP text. |
| Require Acceptance | Require users to accept an AUP before their account is fully enabled. The Login button is not enabled unless the user accepts the AUP. If users do not accept the AUP, they will not obtain network access. |
| Require scrolling to end of AUP | This option displays only if Include an AUP on page is enabled. Ensure that the user has read the AUP completely. The Accept button is enabled only after the user has scrolled to the end of the AUP. |

Related Topics

[Mobile Device Management Portal](#), on page 486

[Create an MDM Portal](#), on page 501

[Mobile Device Manager Interoperability with Cisco ISE](#), on page 6

Portal Settings for My Devices Portals

- **HTTPS Port:** Enter a port value between 8000 to 8999; the default value is 8443 for all the default portals, except the Blacklist Portal, which is 8444. If you upgraded with port values outside this range, they are honored until you modify this window. If you modify this window, update the port setting to comply with this restriction.

If you assign ports used by a non-guest (such as My Devices) portal to a guest portal, an error message appears.

For posture assessments and remediation only, the Client Provisioning portal also uses ports 8905 and 8909. Otherwise, it uses the same ports assigned to the Guest portal.

Portals assigned to the same HTTPS port can use the same Gigabit Ethernet interface or another interface. If they use the same port and interface combination, they must use the same certificate group tag. For example:

- Valid combinations include, using the Sponsor portal as an example:
 - Sponsor portal: Port **8443**, Interface **0**, Certificate tag **A** and My Devices portal: Port **8443**, Interface **0**, Certificate group **A**.
 - Sponsor portal: Port **8443**, Interface **0**, Certificate group **A** and My Devices portal: Port **8445**, Interface **0**, Certificate group **B**.
 - Sponsor portal: Port **8444**, Interface **1**, Certificate group **A** and Blacklist portal: Port **8444**, Interface **0**, Certificate group **B**.
- Invalid combinations include:
 - Sponsor portal: Port **8443**, Interface **0**, Certificate group **A** and My Devices portal: **8443**, Interface **0**, Certificate group **B**.

- Sponsor portal: Port **8444**, Interface **0**, Certificate tag **A** and Blacklist portal: Port **8444**, Interface **0**, Certificate group **A**.



Note We recommend that you use interface 0 for Guest services for best performance. You can either configure only interface 0 in the **Portal Settings**, or you can use the CLI command **ip host** to map a hostname or FQDN to the IP address of interface 0.

- **Allowed Interfaces:** Select the PSN interfaces which a PAN can use to run a portal. When a request to open a portal is made on the PAN, the PAN looks for an available allowed port on the PSN. You must configure the Ethernet interfaces using IP addresses on different subnets.

These interfaces must be available on all the PSNs, including VM-based ones, that have Policy Services turned on. This is a requirement because any of these PSNs can be used for the redirect at the start of the guest session.

- The Ethernet interfaces must use IP addresses on different subnets.
- The interfaces you enable here must be available on all your PSNs, including VM-based ones when Policy Services turned on. This is required because any of these PSNs can be used for a redirect at the start of the guest session.
- The portal certificate Subject Name or Alternate Subject Name must resolve to the interface IP address.
- Configure **ip host x.x.x.x yyy.domain.com** in Cisco ISE CLI to map the secondary interface IP address to the FQDN, which is used to match the certificate Subject Name or Alternate Subject Name.
- If only the bonded NIC is selected, when the PSN attempts to configure the portal it first attempts to configure the Bond interface. If that is not successful, perhaps because there was no bond setup on that PSN, then the PSN logs an error and exits. The PSN will not try to start the portal on the physical interface.
- NIC Teaming or bonding is a configuration option that allows you to configure two individual NICs for high availability (fault tolerance). If one of the NICs fails, the other NIC that is part of the bonded connection continues the connection. A NIC is selected for a portal based in the **Portal Settings** configuration. If both physical NICs and the corresponding bonded NIC are configured, when the PSN attempts to configure the portal, it first attempts to connect to the Bond interface. If that is not successful, perhaps because there was no bond setup on that PSN, then the PSN attempts to start the portal on the physical interface.
- **Certificate Group tag:** Pick a certificate group tag that specifies the certificate to be used for the portal's HTTPS traffic.
- **Fully Qualified Domain Name (FQDN):** Enter at least one unique FQDN or hostname for the Sponsor or MyDevices portal. For example, you can enter **sponsorportal.yourcompany.com, sponsor,** so that when the user enters either of those into a browser, the sponsor portal displays. Separate names with commas, but do not include spaces between entries.

If you change the default FQDN, then also do the following:

- Update your DNS so that the FQDN of the new URL resolves to a valid Policy Services Node (PSN) IP address. Optionally, this address could point to a load balancer virtual IP address that serves a pool of PSNs.
- To avoid certificate warning messages due to name mismatches, include the FQDN of the customized URL, or a wildcard, in the subject alternative name (SAN) attribute of the local server certificate of the Cisco ISE PSN.

- **Authentication Method:** Choose which identity source sequence or Identity Provider (IdP) to use for user authentication. The identity source sequence is a list of identity stores that are searched in sequence to verify user credentials.

Cisco ISE includes a default identity source sequence for sponsor portals, `Sponsor_Portal_Sequence`.

To configure IdP, choose **Administration > Identity Management > External Identity Sources > SAML Id Providers**.

To configure an identity source sequence, choose **Administration > Identity Management > Identity Source Sequences**.

- **Endpoint Identity Group:** Choose an endpoint identity group to track guest devices. Cisco ISE provides the **GuestEndpoints** endpoint identity group to use as a default. You can also create more endpoint identity groups if you choose to not use the default.

Choose an endpoint identity group to track employee devices. Cisco ISE provides the **RegisteredDevices** endpoint identity group to use as a default. You can also create more endpoint identity groups if you choose to not use the default.

- **Purge Endpoints in this Identity Group when they Reach __ Days:** Specify the number of days after which the device is purged from the Cisco ISE database. Purging is done on a daily basis and the purge activity is synchronized with the overall purge timing. The change is applied globally for this endpoint identity group.

If changes are made to the Endpoint Purge Policy based on other policy conditions, this setting is no longer available for use.

- **Idle Timeout:** Enter the time in minutes that you want Cisco ISE to wait before it logs out the user if there is no activity in the portal. The valid range is from 1 to 30 minutes.

- **Display Language**

- **Use Browser Locale:** Use the language specified in the client browser's locale setting as the display language of the portal. If browser locale's language is not supported by Cisco ISE, then the **Fallback Language** is used as the language portal.
- **Fallback Language:** Choose the language to use when the language cannot be obtained from the browser locale, or if the browser locale language is not supported by Cisco ISE.
- **Always Use:** Choose the display language to use for the portal. This setting overrides the **User Browser Locale** option.

Related Topics

[My Devices Portal](#), on page 487

[Create a My Devices Portal](#), on page 503

Login Page Settings for My Devices Portals

- **Maximum Failed Login Attempts Before Rate Limiting:** Specify the number of failed login attempts from a single browser session before Cisco ISE starts to throttle that account. This does not cause an account lockout. The throttled rate is configured in **Time between login attempts when rate limiting**.
- **Maximum Failed Login Attempts Before Rate Limiting:** Specify the number of failed login attempts from a single browser session before Cisco ISE starts to throttle that account. This does not cause an account lockout. The throttled rate is configured in **Time between login attempts when rate limiting**.
- **Include an AUP:** Add a acceptable use policy window to the flow. You can add the AUP to the window, or link to another window.

Related Topics

[My Devices Portal](#), on page 487

[Create a My Devices Portal](#), on page 503

[Monitor My Devices Portals and Endpoints Activity](#), on page 506

Acceptable Use Policy Page Settings for My Devices Portals

| Field | Usage Guidelines |
|--|---|
| Include an AUP Page | Display your company's network-usage terms and conditions on a separate page to the user. |
| Require scrolling to end of AUP | Ensure that the user has read the AUP completely. The Accept button is enabled only after the user has scrolled to the end of the AUP. |
| On First Login only | Display an AUP when the user logs into the network or portal for the first time only. |
| On Every Login | Display an AUP each time the user logs into the network or portal. |
| Every __ Days (starting at first login) | Display an AUP periodically after the user first logs into the network or portal. |

Related Topics

[My Devices Portal](#), on page 487

[Create a My Devices Portal](#), on page 503

Post-Login Banner Page Settings for My Devices Portals

| Field Name | Usage Guidelines |
|---|--|
| Include a Post-Login Banner page | Display additional information after the users successfully log in and before they are granted network access. |

Related Topics

[My Devices Portal](#), on page 487

[Create a My Devices Portal](#), on page 503

Employee Change Password Settings for My Devices Portals

To set the employee password policy, choose **Administration > Identity Management > Settings > Username Password Policy**.

| Field Name | Usage Guidelines |
|--|--|
| Allow internal users to change password | <p>Allow employees to change their passwords after they log into the My Devices portal.</p> <p>This only applies to employees whose accounts are stored in the Cisco ISE database and not to those stored in external databases, such as Active Directory or LDAP.</p> |

Related Topics

[Create a My Devices Portal](#), on page 503

[UTF-8 Character Support in the Portals](#), on page 25

Manage Device Settings for My Devices Portal

Table 131: Manage Device Settings for My Devices Portals

| Field Name | Usage Guidelines |
|------------------|--|
| Lost | <p>Enable employees to indicate that their device is lost. This action updates the device status in the My Devices portal to Lost and adds the device to the Blacklist endpoint identity group.</p> |
| Reinstate | <p>This action reinstates a block listed, lost or stolen device and resets its status to its last known value. This action resets the status of a stolen device to Not Registered, since it has to undergo additional provisioning before it can connect to the network.</p> <p>If you want to prevent employees reinstating devices that you have block listed, do not enable this option in the My Devices portal.</p> |
| Delete | <p>Enable employees to delete a registered device from the My Devices portal or to delete unused and add new devices, when the maximum number of registered devices is reached. This action removes the device from the list of devices displayed in the My Devices portal, but the device remains in the Cisco ISE database and continues to be listed in the Endpoints list.</p> <p>To define the maximum number of personal devices that employees can register using either the BYOD or My Devices portals, choose Administration > Device Portal Management > Settings > Employee Registered Devices.</p> <p>To permanently delete the device from the Cisco ISE database, choose Work Centers > Network Access > Identities > Endpoints.</p> |

| Field Name | Usage Guidelines |
|--------------------|--|
| Stolen | Enable employees to indicate that their device is stolen. This action updates the device status in the My Devices portal to Stolen, adds the device to the Blacklist endpoint identity group, and removes its certificate. |
| Device lock | For MDM enrolled devices only.

Enable employees to immediately lock their device remotely from the My Devices portal, in the event it is lost or stolen. This action prevents unauthorized use of the device.

However, the PIN cannot be set in the My Devices portal and should have already been configured by the employee on their mobile device in advance. |
| Unenroll | For MDM enrolled devices only.

Enable employees to choose this option if they no longer need to use their device at work. This action removes only those applications and settings installed by your company, while retaining other apps and data on the employee's mobile device. |
| Full wipe | For MDM enrolled devices only.

Enable employees to choose this option if they have lost their device or are replacing it with a new one. This action resets the employee's mobile device to its default factory settings, removing installed apps and data. |

Related Topics

[Manage Personal Devices Added by Employees](#), on page 505

[My Devices Portal](#), on page 487

Add, Edit, and Locate Device Customization for My Devices Portals

Under **Page Customizations**, you can customize the messages, titles, content, instructions, and field and button labels that appear on the Add, Edit and Locate tabs of the My Devices portal.

Related Topics

[My Devices Portal](#), on page 487

[Create a My Devices Portal](#), on page 503

Support Information Page Settings for Device Portals

| Field Name | Usage Guidelines |
|---|---|
| Include a Support Information Page | Display a link to an information window, such as Contact Us , on all enabled windows for the portal. |
| MAC Address | Include the MAC address of the device on the Support Information window. |
| IP Address | Include the IP address of the device on the Support Information window. |

| Field Name | Usage Guidelines |
|---|---|
| Browser User Agent | Include the browser details such as the product name and version, layout engine, and version of the user agent originating the request on the Support Information window. |
| Policy Server | Include the IP address of the ISE Policy Service Node (PSN) that is serving this portal on the Support Information window. |
| Failure Code | If available, include the corresponding number from the log message catalog. To view the message catalog, choose Administration > System > Logging > Message Catalog . |
| Hide Field | Do not display any field labels on the Support Information window if the information that they would contain is non-existent. For example, if the failure code is unknown, and therefore blank, do not display Failure Code , even if it is selected. |
| Display Label with no Value | Display all selected field labels on the Support Information window, even if the information that they would contain is non-existent. For example, if the failure code is unknown, display Failure Code , even if it is blank. |
| Display Label with Default Value | Display this text in any selected field on the Support Information window, if the information that they would contain is non-existent. For example, if you enter Not Available in this field, and the failure code is unknown, the Failure Code field displays Not Available . |

Related Topics

[Monitor My Devices Portals and Endpoints Activity](#), on page 506

[Access Device Portals](#), on page 485



CHAPTER 31

Web Portals Customization Reference

- [Portal Pages Titles, Content and Labels Character Limits](#), on page 1067
- [Portal Customization](#), on page 1069
- [HTML Support for a Portal Language File](#), on page 1070

Portal Pages Titles, Content and Labels Character Limits

There is a maximum and minimum range of characters you can enter in the titles, text boxes, instructions, field and button labels, and other visual elements on the **Portal Page Customization** tab.

Character Limits for Portal Pages Titles, Content and Labels

The navigation paths for these portal page UI elements are:

- For Guest portals, choose **Work Centers > Guest Access > Portals & Components > Guest Portals > Edit > Portal Page Customization > Pages**.
- For Sponsor portals, choose **Work Centers > Guest Access > Portals & Components > Sponsor Portals > Edit > Portal Page Customization > Pages**.
- For Device portals, choose **Administration > Device Portal Management > (any Portals) > Edit > Portal Page Customization > Pages**.

Use this information when you enter content in the titles, text boxes, instructions, field and button labels, and other visual elements of the portal page the you are customizing. These updates are applied only to the specific page that you are customizing.



Note Whether you enter single-byte or multi-byte characters, you can only enter the maximum number of characters identified for a field. Multi-byte characters do not affect the character limit.

| Field Category | Fields | Field Labels: Minimum Characters | Field Labels: Maximum Characters | Field Input Values: Minimum Characters | Field Input Values: Maximum Characters |
|-----------------------------|--|----------------------------------|----------------------------------|--|--|
| Common page elements | Banner title | | | | 256 |
| | Footer elements | | | 0 | 2000 |
| | Browser Page Title | | | 0 | 256 |
| | Instructional Text | | | 0 | 2000 |
| | Content Title | | | 0 | 256 |
| | Optional Content 1 | | | 0 | 2000 |
| | Optional Content 2 | | | 0 | 2000 |
| | Button labels | 0 | 64 | | |
| | Check box labels | 0 | 64 | | |
| | Tab labels | 0 | 64 | | |
| | Link labels | 0 | 256 | | |
| AUP | AUP Text | | | 0 | 50,000 |
| Message text | Message text (displayed on page) | | | 0 | 2000 |
| | Message text (displayed in pop-up window) | | | 0 | 256 |
| Field labels | All fields labels | 0 | 256 | | |
| Field input (general) | Field input in general (see special cases below) | | | 0 | 256 |
| Field input (special cases) | Access Code field | | | 1 | 20 |
| | Registration Code field | | | 1 | 20 |
| | Username fields | | | 1 | 64 |
| | Password fields | | | 1 | 256 |
| | Phone Number field | | | 0 | 64 |

| Field Category | Fields | Field Labels: Minimum Characters | Field Labels: Maximum Characters | Field Input Values: Minimum Characters | Field Input Values: Maximum Characters |
|----------------|-----------------|----------------------------------|----------------------------------|--|--|
| | Device ID field | | | 12 | 17 |

Portal Customization

You can customize the appearance of the end-user web portals and the guest experience. If you have experience with the cascading style sheet (CSS) language and with Javascript, you can use the jQuery Mobile ThemeRoller application to customize portal themes by changing the portal page layout.

You can view all the fields by exporting the CSS theme or language properties from the required portal page. See [Export a Portal's Default Theme CSS File](#) for more information.

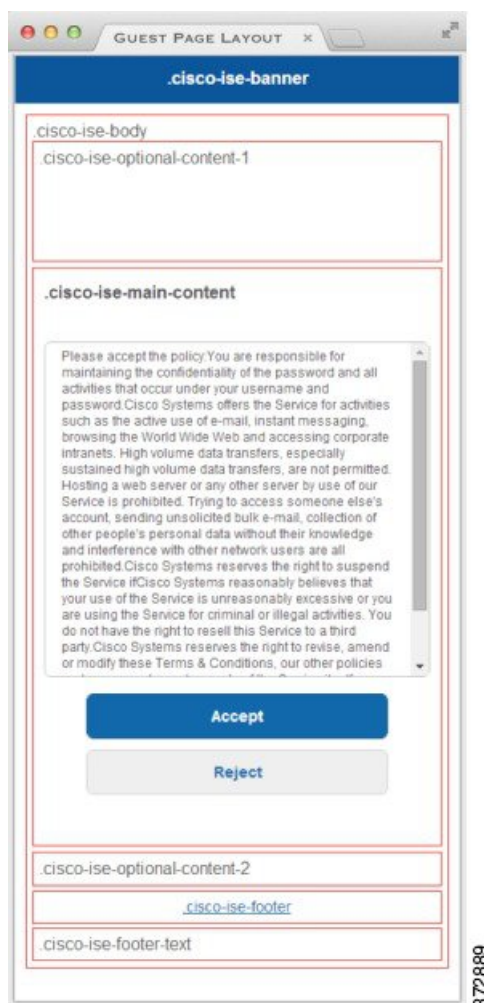
CSS Classes and Descriptions for End-User Portals Page Layout

Use these CSS classes to define and modify the page layout of the Cisco ISE end-user web portals.

| CSS Class Name | Description |
|------------------------------|---|
| cisco-ise-banner | Includes logos, banner image, and banner text.

On the Sponsor and My Devices portals, this class also contains buttons that can activate a context menu. For example, the menu can bring up a pop-up window with options to Log Out , Change Password , and so on. |
| cisco-ise-body | Contains all page elements that are not part of the banner. |
| cisco-ise-optional-content-1 | Empty by default. You can add text, links, and HTML and Javascript code. |
| cisco-ise-main-content | Includes the main contents of the portal page, such as instructional text, action buttons, and the cisco-ise-footer container. |
| cisco-ise-optional-content-2 | Empty by default. You can add text, links, and HTML and Javascript code. |
| cisco-ise-footer | Part of the footer, it is a placeholder for links such as Contact Support and online Help . |
| cisco-ise-footer-text | Empty by default. It is a placeholder for anything that you want to display at the bottom of the portal page, such as a copyright notice or a disclaimer. |

Figure 73: CSS Classes Used in the End-User Portal Page Layout



HTML Support for a Portal Language File

The zipped language file for each portal includes the default language properties files for that portal. Each properties file includes dictionary keys that define the content that displays on the portal.

You can customize the text that displays on a portal, including the content in the **Instructional Text**, **Content**, **Optional Content 1**, and **Optional Content 2** fields. Some of these fields have default content and some are empty.

Only some of these dictionary keys associated with these fields support HTML in their values (text).

HTML Support for the Blacklist Portal Language File

The navigation path to this portal's **Instructional Text**, **Content**, **Optional Content 1**, and **Optional Content 2** text boxes is **Administration > Device Portal Management > Blacklist Portal > Edit > Portal Page**

Customization > Pages. You can use the **View HTML Source** icon in the mini-editor and add HTML code in your content.

These dictionary keys in the portal's language properties files support HTML in their text.



Note This is not a complete list of the dictionary keys in the files.

- key.blacklist.ui_reject_message

HTML Support for Bring Your Own Device Portals Language Files

The navigation path to this portal's **Instructional Text**, **Content**, **Optional Content 1**, and **Optional Content 2** text boxes is **Administration > Device Portal Management > BYOD Portals > Edit > Portal Page Customization > Pages.** You can use the **View HTML Source** icon in the mini-editor and add HTML code in your content.

These dictionary keys in the portal's language properties files support HTML in their text.



Note This is not a complete list of the dictionary keys in the files.

- key.guest.ui_contact_instruction_message
- key.guest.ui_byod_welcome_optional_content_1
- key.guest.ui_byod_welcome_optional_content_2
- key.guest.ui_byod_reg_limit_message
- key.guest.ui_byod_reg_content_message
- key.guest.ui_byod_success_manual_reconnect_message
- key.guest.ui_byod_install_winmac_instruction_message
- key.guest.ui_byod_install_optional_content_1
- key.guest.ui_byod_reg_optional_content_2
- key.guest.ui_byod_install_optional_content_2
- key.guest.ui_byod_reg_optional_content_1
- key.guest.ui_byod_reg_instruction_message
- key.guest.ui_byod_welcome_aup_text
- key.guest.ui_contact_optional_content_2
- key.guest.ui_contact_optional_content_1
- key.guest.ui_byod_install_ios_instruction_message
- key.guest.ui_byod_welcome_instruction_message

- key.guest.ui_error_optional_content_2
- key.guest.ui_error_optional_content_1
- key.guest.ui_byod_welcome_renew_cert_message
- key.guest.ui_byod_install_android_instruction_message
- key.guest.ui_byod_install_instruction_message
- key.guest.ui_byod_welcome_config_device_message
- key.guest.ui_byod_success_message
- key.guest.ui_byod_success_unsupported_device_message
- key.guest.ui_byod_success_optional_content_1
- key.guest.ui_byod_success_optional_content_2
- key.guest.ui_error_instruction_message

HTML Support for Certificate Provisioning Portal Language Files

The navigation path to this portal's **Instructional Text**, **Content**, **Optional Content 1**, and **Optional Content 2** text boxes is **Administration > Device Portal Management > Certificate Provisioning Portal > Edit > Portal Page Customization > Pages**. You can use the **View HTML Source** icon in the mini-editor and add HTML code in your content.

These dictionary keys in the portal's language properties files support HTML in their text.



Note This is not a complete list of the dictionary keys in the files.

- key.manualcertprov.ui_login_instruction_message
- key.manualcertprov.ui_aup_instruction_message
- key.manualcertprov.ui_changepwd_instruction_message
- key.manualcertprov.ui_post_access_instruction_message
- key.manualcertprov.ui_status_csv_invalid_instruction_message
- key.manualcertprov.ui_login_optional_content_1
- key.manualcertprov.ui_login_optional_content_2
- key.manualcertprov.ui_aup_optional_content_1
- key.manualcertprov.ui_aup_optional_content_2
- key.manualcertprov.ui_changepwd_optional_content_1
- key.manualcertprov.ui_changepwd_optional_content_2
- key.manualcertprov.ui_post_access_optional_content_1

- key.manualcertprov.ui_post_access_optional_content_2
- key.manualcertprov.ui_landing_instruction_message
- key.manualcertprov.ui_status_page_single_generated_content
- key.manualcertprov.ui_status_generated_content

HTML Support for Client Provisioning Portal Language Files

The navigation path to this portal's **Instructional Text**, **Content**, **Optional Content 1**, and **Optional Content 2** text boxes is **Administration** > **Device Portal Management** > **Client Provisioning Portals** > **Edit** > **Portal Page Customization** > **Pages**. You can use the **View HTML Source** icon in the mini-editor and add HTML code in your content.

These dictionary keys in the portal's language properties files support HTML in their text.



Note This is not a complete list of the dictionary keys in the files.

- key.guest.ui_client_provision_agent_installed_instructions_without_java_message
- key.guest.ui_contact_instruction_message
- key.guest.ui_success_message
- key.guest.ui_client_provision_unable_to_detect_message
- key.guest.ui_client_provision_instruction_message
- key.guest.ui_client_provision_agent_installation_message
- key.guest.ui_client_provision_posture_agent_check_message
- key.guest.ui_vlan_instruction_message
- key.guest.ui_client_provision_agent_installation_instructions_with_no_java_message
- key.guest.ui_success_instruction_message
- key.guest.ui_vlan_optional_content_1
- key.guest.ui_vlan_optional_content_2
- key.guest.ui_contact_optional_content_2
- key.guest.ui_contact_optional_content_1
- key.guest.ui_contact_optional_content_1
- key.guest.ui_client_provision_posture_check_compliant_message
- key.guest.ui_client_provision_optional_content_2
- key.guest.ui_client_provision_optional_content_1
- key.guest.ui_error_optional_content_2

- key.guest.ui_error_optional_content_1
- key.guest.ui_client_provision_posture_check_non_compliant_message
- key.guest.ui_vlan_install_message
- key.guest.ui_success_optional_content_1
- key.guest.ui_success_optional_content_2
- key.guest.ui_client_provision_posture_agent_scan_message

HTML Support for Credential Guest Portals Language Files

The navigation path to this portal's **Instructional Text**, **Content**, **Optional Content 1**, and **Optional Content 2** text boxes is **Work Centers > Guest Access > Portals & Components > Guest Portals > Edit > Portal Page Customization > Pages**. You can use the **View HTML Source** icon in the mini-editor and add HTML code in your content.

These dictionary keys in the portal's language properties files support HTML in their text.



Note This is not a complete list of the dictionary keys in the files.

- key.guest.ui_contact_instruction_message
- key.guest.ui_login_optional_content_1
- key.guest.ui_login_optional_content_2
- key.guest.ui_client_provision_unable_to_detect_message
- key.guest.ui_client_provision_instruction_message
- key.guest.ui_device_reg_optional_content_2
- key.guest.ui_device_reg_optional_content_1
- key.guest.ui_byod_success_manual_reconnect_message
- key.guest.ui_byod_reg_optional_content_2
- key.guest.ui_byod_reg_optional_content_1
- key.guest.ui_client_provision_agent_installation_instructions_with_no_java_message
- key.guest.ui_success_instruction_message
- key.guest.ui_max_devices_instruction_message
- key.guest.ui_max_devices_optional_content_1
- key.guest.ui_self_reg_results_instruction_message
- key.guest.notification_credentials_email_body
- key.guest.ui_max_devices_optional_content_2

- key.guest.ui_contact_optional_content_2
- key.guest.ui_contact_optional_content_1
- key.guest.ui_byod_install_ios_instruction_message
- key.guest.ui_changepwd_instruction_message
- key.guest.ui_client_provision_posture_check_compliant_message
- key.guest.ui_aup_instruction_message
- key.guest.ui_changepwd_optional_content_2
- key.guest.ui_changepwd_optional_content_1
- key.guest.ui_self_reg_results_optional_content_2
- key.guest.ui_self_reg_results_optional_content_1
- key.guest.ui_device_reg_instruction_message
- key.guest.ui_byod_welcome_renew_cert_message
- key.guest.ui_vlan_execute_message
- key.guest.ui_byod_install_android_instruction_message
- key.guest.ui_client_provision_posture_check_non_compliant_message
- key.guest.ui_byod_install_instruction_message
- key.guest.ui_device_reg_max_reached_message
- key.guest.ui_byod_success_message
- key.guest.ui_byod_success_unsupported_device_message
- key.guest.ui_byod_success_optional_content_1
- key.guest.ui_byod_success_optional_content_2
- key.guest.ui_aup_employee_text
- key.guest.ui_client_provision_agent_installed_instructions_without_java_message
- key.guest.ui_success_message
- key.guest.ui_byod_welcome_optional_content_1
- key.guest.ui_byod_welcome_optional_content_2
- key.guest.ui_self_reg_optional_content_2
- key.guest.ui_self_reg_optional_content_1
- key.guest.ui_byod_reg_limit_message
- key.guest.notification_credentials_print_body
- key.guest.ui_byod_reg_content_message
- key.guest.ui_client_provision_agent_installation_message

- key.guest.ui_post_access_message
- key.guest.ui_vlan_instruction_message
- key.guest.ui_byod_install_winmac_instruction_message
- key.guest.ui_aup_guest_text
- key.guest.ui_byod_install_optional_content_1
- key.guest.ui_byod_install_optional_content_2
- key.guest.ui_byod_reg_instruction_message
- key.guest.ui_aup_optional_content_1
- key.guest.ui_aup_optional_content_2
- key.guest.ui_self_reg_aup_text
- key.guest.ui_login_instruction_message
- key.guest.ui_vlan_optional_content_1
- key.guest.ui_vlan_optional_content_2
- key.guest.ui_self_reg_results_aup_text
- key.guest.ui_device_reg_register_message
- key.guest.ui_byod_welcome_instruction_message
- key.guest.ui_client_provision_optional_content_2
- key.guest.ui_self_reg_instruction_message
- key.guest.ui_vlan_install_message
- key.guest.ui_success_optional_content_1
- key.guest.ui_success_optional_content_2
- key.guest.ui_post_access_instruction_message
- key.guest.ui_post_access_optional_content_2
- key.guest.ui_post_access_optional_content_1
- key.guest.ui_byod_welcome_config_device_message
- key.guest.ui_client_provision_posture_agent_scan_message

HTML Support for Hotspot Guest Portals Language Files

The navigation path to this portal's **Instructional Text**, **Content**, **Optional Content 1**, and **Optional Content 2** text boxes is **Work Centers > Guest Access > Portals & Components > Guest Portals > Edit > Portal Page Customization > Pages**. You can use the **View HTML Source** icon in the mini-editor and add HTML code in your content.

These dictionary keys in the portal's language properties files support HTML in their text.



Note This is not a complete list of the dictionary keys in the files.

- key.guest.ui_contact_instruction_message
- key.guest.ui_success_message
- key.guest.ui_post_access_message
- key.guest.ui_vlan_instruction_message
- key.guest.ui_success_instruction_message
- key.guest.ui_aup_optional_content_1
- key.guest.ui_aup_optional_content_2
- key.guest.ui_vlan_unsupported_error_message
- key.guest.ui_vlan_optional_content_1
- key.guest.ui_vlan_optional_content_2
- key.guest.ui_contact_optional_content_2
- key.guest.ui_contact_optional_content_1
- key.guest.ui_aup_instruction_message
- key.guest.ui_aup_hotspot_text
- key.guest.ui_vlan_execute_message
- key.guest.ui_vlan_install_message
- key.guest.ui_success_optional_content_1
- key.guest.ui_success_optional_content_2
- key.guest.ui_post_access_instruction_message
- key.guest.ui_post_access_optional_content_2
- key.guest.ui_post_access_optional_content_1

HTML Support for Mobile Device Management Portals Language Files

The navigation path to this portal's **Instructional Text**, **Content**, **Optional Content 1**, and **Optional Content 2** text boxes is **Administration** > **Device Portal Management** > **MDM Portals** > **Edit** > **Portal Page Customization** > **Pages**. You can use the **View HTML Source** icon in the mini-editor and add HTML code in your content.

These dictionary keys in the portal's language properties files support HTML in their text.

- key.mdm.ui_contact_instruction_message
- key.mdm.ui_mdm_enrollment_after_message

- key.mdm.ui_error_optional_content_2
- key.mdm.ui_error_optional_content_1
- key.mdm.ui_mdm_enroll_optional_content_1
- key.mdm.ui_mdm_enroll_optional_content_1
- key.mdm.ui_mdm_enroll_optional_content_2
- key.mdm.ui_mdm_enroll_instruction_message
- key.mdm.ui_error_instruction_message
- key.mdm.ui_mdm_enrollment_link_message
- key.mdm.ui_mdm_not_reachable_message
- key.mdm.ui_contact_optional_content_2
- key.mdm.ui_mdm_continue_message
- key.mdm.ui_contact_optional_content_1

HTML Support for My Devices Portals Language Files

The navigation path to this portal's **Instructional Text**, **Content**, **Optional Content 1**, and **Optional Content 2** text boxes is **Administration** > **Device Portal Management** > **My Devices Portals** > **Edit** > **Portal Page Customization** > **Pages**. You can use the **View HTML Source** icon in the mini-editor and add HTML code in your content.

These dictionary keys in the portal's language properties files support HTML in their text.



Note This is not a complete list of the dictionary keys in the files.

- key.mydevices.ui_add_optional_content_1
- key.mydevices.ui_add_optional_content_2
- key.mydevices.ui_post_access_instruction_message
- key.mydevices.ui_edit_instruction_message
- key.mydevices.ui_contact_optional_content_2
- key.mydevices.ui_contact_optional_content_1
- key.mydevices.ui_changepwd_optional_content_1
- key.mydevices.ui_changepwd_optional_content_2
- key.mydevices.ui_post_access_message
- key.mydevices.ui_home_instruction_message
- key.mydevices.ui_edit_optional_content_1

- key.mydevices.ui_edit_optional_content_2
- key.mydevices.ui_add_instruction_message
- key.mydevices.ui_post_access_optional_content_2
- key.mydevices.ui_post_access_optional_content_1
- key.mydevices.ui_error_instruction_message
- key.mydevices.ui_actions_instruction_message
- key.mydevices.ui_home_optional_content_2
- key.mydevices.ui_aup_optional_content_1
- key.mydevices.ui_aup_optional_content_2
- key.mydevices.ui_home_optional_content_1
- key.mydevices.ui_changepwd_instruction_message
- key.mydevices.ui_contact_instruction_message
- key.mydevices.ui_aup_employee_text
- key.mydevices.ui_login_optional_content_2
- key.mydevices.ui_login_optional_content_1
- key.mydevices.ui_login_instruction_message
- key.mydevices.ui_error_optional_content_1
- key.mydevices.ui_error_optional_content_2
- key.mydevices.ui_aup_instruction_message

HTML Support for Sponsor Portals Language Files

The navigation path to this portal's **Instructional Text**, **Content**, **Optional Content 1**, and **Optional Content 2** text boxes is **Work Centers > Guest Access > Portals & Components > Sponsor Portals > Edit > Portal Page Customization > Pages**. You can use the **View HTML Source** icon in the mini-editor and add HTML code in your content.

These dictionary keys in the portal's language properties files support HTML in their text.



Note This is not a complete list of the dictionary keys in the files.

- key.sponsor.ui_aup_instruction_message
- key.sponsor.ui_create_random_instruction_message
- key.sponsor.ui_home_instruction_message
- key.sponsor.ui_post_access_instruction_message

- key.sponsor.notification_credentials_print_body
- key.sponsor.ui_aup_sponsor_text
- key.sponsor.ui_create_accounts_access_info_instruction_message
- key.sponsor.ui_login_instruction_message
- key.sponsor.notification_credentials_email_body
- key.sponsor.ui_create_known_instruction_message
- key.sponsor.ui_create_import_instruction_message
- key.sponsor.ui_suspend_account_instruction_message
- key.sponsor.ui_post_access_message
- key.sponsor.ui_login_optional_content_2
- key.sponsor.ui_login_optional_content_1
- key.sponsor.notification_credentials_email_password_body
- key.sponsor.ui_contact_optional_content_2
- key.sponsor.ui_contact_optional_content_1
- key.sponsor.ui_login_aup_text
- key.sponsor.ui_changepwd_instruction_message
- key.sponsor.ui_create_accounts_guest_type_instruction_message
- key.sponsor.ui_changepwd_optional_content_1
- key.sponsor.ui_changepwd_optional_content_2
- key.sponsor.notification_credentials_email_username_body
- key.sponsor.ui_aup_optional_content_1
- key.sponsor.ui_aup_optional_content_2
- key.sponsor.ui_post_access_optional_content_1
- key.sponsor.ui_post_access_optional_content_2
- key.sponsor.ui_contact_instruction_message



CHAPTER 32

Policy User Interface Reference

- [Authentication, on page 1081](#)
- [Authorization Policy Settings, on page 1086](#)
- [Endpoint Profiling Policies Settings, on page 1087](#)
- [Endpoint Context Visibility Using UDID Attribute, on page 1092](#)
- [RADIUS Vendor Dictionary Attribute Settings, on page 1092](#)
- [Conditions, on page 1093](#)
- [Results, on page 1116](#)

Authentication

This section describes the authentication policy page, which allows you to configure simple and rule-based authentication policies.

Simple Authentication Policy Configuration Settings

The following table describes the fields in the simple authentication policy page, which allows you to configure simple authentication policies. The navigation path for this page is: **Policy > Authentication**.

Table 132: Simple Authentication Policy Configuration Settings

| Fields | Usage Guidelines |
|------------------------|--|
| Network Access Service | Choose an allowed protocol that you have already created. |
| Identity Source | Choose the identity source that you want to use for authentication. You can also choose an identity source sequence if you have configured it.

You can edit the default identity source that you want Cisco ISE to use in case none of the identity sources defined in this rule match the request. |

| Fields | Usage Guidelines |
|---------|---|
| Options | <p>Define a further course of action for authentication failure, user not found, or process failure events. You can choose one of the following options:</p> <ul style="list-style-type: none"> • Reject—A reject response is sent. • Drop—No response is sent. • Continue—Cisco ISE proceeds with the authorization policy. |

Related Topics

[Simple Authentication Policies](#), on page 564

[Simple Authentication Policy Flow](#), on page 565

[Guidelines for Configuring Simple Authentication Policies](#), on page 566

[Configure a Simple Authentication Policy](#), on page 587

Rule-Based Authentication Policy Configuration Settings

The following table describes the fields in the rule-based authentication policy page, which allows you to configure simple authentication policies. The navigation path for this page is: **Policy** > **Authentication** > **Rule-Based**.

Table 133: Rule-Based Authentication Policy Configuration Settings

| Fields | Usage Guidelines |
|---------------|--|
| Status | <p>Choose the status of this policy. It can be one of the following:</p> <ul style="list-style-type: none"> • Enabled—This policy condition is active. • Disabled—This policy condition is inactive and will not be evaluated. • Monitor Only—This policy condition will be evaluated, but the result will not be enforced. You can view the results of this policy condition in the Live Log authentication page. In this, see the detailed report which will have the monitored step and attribute. For example, you may want to add a new policy condition, but are not sure if the condition would provide you with the correct results. In this situation, you can create the policy condition in monitored mode to view the results and then enable it if you are satisfied with the results. |
| Standard Rule | Enter a name for this policy and select condition and allowed protocol. |

| Fields | Usage Guidelines |
|------------|---|
| Conditions | <p>Click the plus [+] sign to expand the Conditions anchored overlay, and click the minus [-] sign, or click outside the anchored overlay to close it:</p> <ul style="list-style-type: none">• Select Existing Condition from Library or Create New Condition (Advanced Option)• Select Existing Condition from Library—You can define an expression by selecting Cisco predefined conditions from the policy elements library.• Create New Condition (Advanced Option)—You can define an expression by selecting attributes from various system or user-defined dictionaries. |

| Fields | Usage Guidelines |
|--|---|
| Select Existing Condition from Library | <p>You can do the following:</p> <ol style="list-style-type: none"> 1. You can choose the predefined conditions that you would have defined for authentication in the policy elements, and then use an AND or OR operator to add multiple conditions.
 You cannot select certain predefined conditions that contain the following dictionaries or attributes: <ul style="list-style-type: none"> • Dictionary "Certificate", with any attribute • Dictionary "Network Access", with the following attributes: <ul style="list-style-type: none"> • Device IP Address • ISE Host Name • NetworkDeviceName • Protocol • UseCase In case such conditions are available, the first entry in the select box will be "Only relevant conditions are selectable". 2. Click the Action icon to do the following in the subsequent steps: <ul style="list-style-type: none"> • Add Attribute/Value—You can add ad-hoc attribute/value pairs • Add Condition from Library—You can add Cisco predefined conditions • Duplicate—Create a copy of the selected condition • Add Condition to Library— You can save ad-hoc attribute/value pairs that you create to the policy elements library • Delete—Delete the selected condition |

| Fields | Usage Guidelines |
|---------------------------------------|---|
| Create New Condition (Advance Option) | <p>You can do the following:</p> <ol style="list-style-type: none"> 1. You can add ad-hoc attribute/value pairs to your expression, and then use an AND or OR operator to add multiple conditions. 2. Click the Action icon to do the following in the subsequent steps: <ul style="list-style-type: none"> • Add Attribute/Value—You can add ad-hoc attribute/value pairs • Add Condition from Library—You can add Cisco predefined conditions • Duplicate—Create a copy of the selected condition • Add Condition to Library— You can save ad-hoc attribute/value pairs that you create to the policy elements library • Delete—Delete the selected condition. Here, you can use the AND or OR operator |
| Select Network Access | Choose from allowed protocols or RADIUS server sequence. |
| Arrow Button | Click to define conditions for the identity source selection. |
| Identity Source Sequence | <p>You can do the following:</p> <ol style="list-style-type: none"> 1. Click the action icon in the default identity source row, and click Insert new row above. 2. Enter a name for your identity source rule. 3. Click the button to define the conditions based on which you want to choose the identity source. 4. Choose the identity source sequence or the identity source and the action that you want Cisco ISE to take. |

Related Topics

[Rule-Based Authentication Policies](#), on page 566

[Rule-Based Authentication Policy Flow](#), on page 566

[Configure a Rule-Based Authentication Policy](#), on page 588

Authorization Policy Settings

The following table describes the fields in the authorization policy page, which allows you to configure authorization policies. The navigation path for this page is: **Policy > Authorization**.

Table 134: Authorization Policy Settings

| Fields | Usage Guidelines |
|---|---|
| Status | <p>Choose one of the following to enforce the policies:</p> <ul style="list-style-type: none"> • Enabled—This policy condition is active. • Disabled—This policy condition is inactive and will not be evaluated. • Monitor Only—This policy condition will be evaluated, but the result will not be enforced. You can view the results of this policy condition in the Live Log authentication page. In this, see the detailed report which will have the monitored step and attribute. For example, you may want to add a new policy condition, but are not sure if the condition would provide you with the correct results. In this situation, you can create the policy condition in monitored mode to view the results and then enable it if you are satisfied with the results. |
| Rule Name | Enter a name for the Rule Name. |
| Conditions (identity groups and other conditions) | <p>Choose an identity group from the first drop-down.</p> <p>Choose a condition from the second drop-down.</p> <p>You can either select from the existing conditions or create a new condition.</p> |
| Permissions | Choose an authorization profile from the Standard category. |

Related Topics

[Cisco ISE Authorization Policies](#), on page 597

[Guidelines for Configuring Authorization Policies and Profiles](#), on page 600

[Configure Authorization Policies](#), on page 605

Endpoint Profiling Policies Settings

Table 135: Endpoint Profiling Policies Settings

| Field Name | Usage Guidelines |
|--|---|
| Name | Enter the name of the endpoint profiling policy that you want to create. |
| Description | Enter the description of the endpoint profiling policy that you want to create. |
| Policy Enabled | By default, the Policy Enabled check box is checked to associate a matching profiling policy when you profile an endpoint.

When unchecked, the endpoint profiling policy is excluded when you profile an endpoint. |
| Minimum Certainty Factor | Enter the minimum value that you want to associate with the profiling policy. The default value is 10. |
| Exception Action | Choose an exception action, which you want to associate with the conditions when defining a rule in the profiling policy.

The default is NONE. The exception actions are defined in the following location: Policy > Policy Elements > Results > Profiling > Exception Actions . |
| Network Scan (NMAP) Action | Choose a network scan action from the list, which you want to associate with the conditions when defining a rule in the profiling policy, if required.

The default is NONE. The exception actions are defined in the following location: Policy > Policy Elements > Results > Profiling > Network Scan (NMAP) Actions . |
| Create an Identity Group for the policy | Check one of the following options to create an endpoint identity group: <ul style="list-style-type: none"> • Yes, create matching Identity Group • No, use existing Identity Group hierarchy |

| Field Name | Usage Guidelines |
|--|---|
| Yes, create matching Identity Group | <p>Choose this option to use an existing profiling policy.</p> <p>This option creates a matching identity group for those endpoints and the identity group will be the child of the Profiled endpoint identity group when an endpoint profile matches an existing profiling policy.</p> <p>For example, the Xerox-Device endpoint identity group is created in the Endpoints Identity Groups page when endpoints discovered on your network match the Xerox-Device profile.</p> |
| No, use existing Identity Group hierarchy | <p>Check this check box to assign endpoints to the matching parent endpoint identity group using hierarchical construction of profiling policies and identity groups.</p> <p>This option allows you to make use of the endpoint profiling policies hierarchy to assign endpoints to one of the matching parent endpoint identity groups, as well as to the associated endpoint identity groups to the parent identity group.</p> <p>For example, endpoints that match an existing profile are grouped under the appropriate parent endpoint identity group. Here, endpoints that match the Unknown profile are grouped under Unknown, and endpoints that match an existing profile are grouped under the Profiled endpoint identity group. For example,</p> <ul style="list-style-type: none"> • If endpoints match the Cisco-IP-Phone profile, then they are grouped under the Cisco-IP-Phone endpoint identity group. • If endpoints match the Workstation profile, then they are grouped under the Workstation endpoint identity group. <p>The Cisco-IP-Phone and Workstation endpoint identity groups are associated to the Profiled endpoint identity group in the system.</p> |
| Parent Policy | <p>Choose a parent profiling policy that are defined in the system to which you want to associate the new endpoint profiling policy.</p> <p>You can choose a parent profiling policy from which you can inherit rules and conditions to its child.</p> |

| Field Name | Usage Guidelines |
|----------------------------|--|
| Associated CoA Type | Choose one of the following CoA types that you want to associate with the endpoint profiling policy: <ul style="list-style-type: none">• No CoA• Port Bounce• Reauth• Global Settings that is applied from the profiler configuration set in Administration > System > Settings > Profiling |
| Rules | One or more rules that are defined in endpoint profiling policies determine the matching profiling policy for endpoints, which allows you to group endpoints according to their profiles.

One or more profiling conditions from the policy elements library are used in rules for validating endpoint attributes and their values for the overall classification. |

| Field Name | Usage Guidelines |
|--------------------------|--|
| <p>Conditions</p> | <p>Click the plus [+] sign to expand the Conditions anchored overlay, and click the minus [-] sign, or click outside the anchored overlay to close it.</p> <p>Click Select Existing Condition from Library or Create New Condition (Advanced Option) .</p> <p>Select Existing Condition from Library: You can define an expression by selecting Cisco predefined conditions from the policy elements library.</p> <p>Create New Condition (Advanced Option): You can define an expression by selecting attributes from various system or user-defined dictionaries.</p> <p>You can associate one of the following with the profiling conditions:</p> <ul style="list-style-type: none"> • An integer value for the certainty factor for each condition • Either an exception action or a network scan action for that condition <p>Choose one of the following predefined settings to associate with the profiling condition:</p> <ul style="list-style-type: none"> • Certainty Factor Increases: Enter the certainty value for each rule, which can be added for all the matching rules with respect to the overall classification. • Take Exception Action: Triggers an exception action that is configured in the Exception Action field for this endpoint profiling policy. • Take Network Scan Action: Triggers a network scan action that is configured in the Network Scan (NMAP) Action field for this endpoint profiling policy. |

| Field Name | Usage Guidelines |
|---|--|
| Select Existing Condition from Library | <p>You can do the following:</p> <ul style="list-style-type: none"> • You can choose Cisco predefined conditions that are available in the policy elements library, and then use an AND or OR operator to add multiple conditions. • Click the Action icon to do the following in the subsequent steps: <ul style="list-style-type: none"> • Add Attribute or Value: You can add ad-hoc attribute or value pairs • Add Condition from Library: You can add Cisco predefined conditions • Duplicate: Create a copy of the selected condition • Add Condition to Library: You can save ad-hoc attribute/value pairs that you create to the policy elements library • Delete: Delete the selected condition. |
| Create New Condition (Advance Option) | <p>You can do the following:</p> <ul style="list-style-type: none"> • You can add ad-hoc attribute/value pairs to your expression, and then use an AND or OR operator to add multiple conditions. • Click the Action icon to do the following in the subsequent steps: <ul style="list-style-type: none"> • Add Attribute or Value: You can add ad-hoc attribute or value pairs • Add Condition from Library: You can add Cisco predefined conditions • Duplicate: Create a copy of the selected condition • Add Condition to Library: You can save ad-hoc attribute/value pairs that you create to the policy elements library • Delete: Delete the selected condition. You can use the AND or OR operator |

Related Topics

[Cisco ISE Profiling Service](#), on page 633

[Create Endpoint Profiling Policies](#), on page 673

[Endpoint Context Visibility Using UDID Attribute](#), on page 1092

Endpoint Context Visibility Using UDID Attribute

The Unique Identifier (UDID) is an endpoint attribute that identifies MAC addresses of a particular endpoint. An endpoint can have multiple MAC addresses. For example, one MAC address for the wired interface and another for the wireless interface. The AnyConnect agent generates a UDID for that endpoint, and saves it as an endpoint attribute. The UDID remains constant for an endpoint; the UDID does not change with the AnyConnect installation or uninstallation. When using UDID, **Context Visibility** window (**Context Visibility** > **Endpoints** > **Compliance**) displays one entry instead of multiple entries for endpoints with multiple NICs. You can ensure posture control on a specific endpoint rather than on a Mac address.



Note The endpoint must have AnyConnect 4.7 or higher to create the UDID.

RADIUS Vendor Dictionary Attribute Settings

This section describes RADIUS vendor dictionaries used in Cisco ISE.

The following table describes the fields in the Dictionary window for RADIUS vendors, which allows you to configure dictionary attributes for the RADIUS vendors. The navigation path for this window is **Policy** > **Policy Elements** > **Dictionaries** > **System** > **RADIUS** > **RADIUS Vendors**.

Table 136: RADIUS Vendor Dictionary Attribute Settings

| Field Name | Usage Guidelines |
|----------------|--|
| Attribute Name | Enter the vendor specific attribute name for the selected RADIUS vendor. |
| Description | Enter an optional description for the vendor specific attribute. |
| Internal Name | Enter the name for the vendor specific attribute that refers to it internally in the database. |
| Data Type | Choose one of the following data types for the vendor specific attribute: <ul style="list-style-type: none"> • STRING • OCTET_STRING • UNIT32 • UNIT64 • IPV4 • IPV6 |

| Field Name | Usage Guidelines |
|--|---|
| Enable MAC option | <p>Check this check box to enable the comparison of RADIUS attribute as MAC address. By default, for the RADIUS attribute calling-station-id this option is marked as enabled and you cannot disable it. For other dictionary attributes (of string types) within the RADIUS vendor dictionary, you can enable or disable this option.</p> <p>Once you enable this option, while setting the authentication and authorization conditions, you can define whether the comparison is clear string by selecting the Text option or whether it is MAC address by selecting the MAC address option.</p> |
| Direction | Choose one of the options that applies to RADIUS messages: |
| ID | Enter the vendor attribute ID. The valid range is 0 to 255. |
| Allow Tagging | <p>Check this check box to mark the attribute as being permitted to have a tag, as defined in RFC2868. The purpose of the tag is to allow grouping of attributes for tunnelled users. See RFC2868 for more details.</p> <p>The tagged attributes support ensures that all attributes pertaining to a given tunnel contain the same value in their respective tag fields, and that each set includes an appropriately-valued instance of the Tunnel-Preference attribute. This conforms to the tunnel attributes that are to be used in a multi-vendor network environment, thereby eliminating interoperability issues among Network Access Servers (NASs) manufactured by different vendors.</p> |
| Allow Multiple Instances of this Attribute in a Profile | Check this check box when you want multiple instances of this RADIUS vendor specific attribute in profiles. |

Related Topics

[System Defined Dictionaries and Dictionary Attributes](#), on page 263

[User-Defined Dictionaries and Dictionary Attributes](#), on page 264

[RADIUS-Vendor Dictionaries](#), on page 265

[Create RADIUS-Vendor Dictionaries](#), on page 266

Conditions

This section describes policy conditions used for profiling endpoints, posture clients, and to limit or extend permission to access to Cisco ISE system resources.

Profiler Condition Settings

The following table describes the fields in the Profiler Condition window. The navigation path for this window is **Policy > Policy Elements > Conditions > Profiling**.

Table 137: Profiler Condition Settings

| Field Name | Usage Guidelines |
|------------------------|--|
| Name | Name of the profiler condition. |
| Description | Description of the profiler condition. |
| Type | Choose any one of the predefined types. |
| Attribute Name | Choose an attribute on which to base the profiler condition. |
| Operator | Choose an operator. |
| Attribute Value | Enter the value for the attribute that you have chosen. For Attribute Names that contain pre-defined Attribute Values, this option displays a drop-down list with the pre-defined values, and you can choose a value. |
| System Type | Profiling conditions can be any one of the following types: <ul style="list-style-type: none"> • Cisco Provided: Profiling conditions that are provided by Cisco ISE when deployed are identified as Cisco Provided. You cannot edit or delete them from the system. • Administrator Created: Profiling conditions that you create as an administrator of Cisco ISE are identified as Administrator Created. |

Related Topics

[Cisco ISE Profiling Service](#), on page 633

[Profiler Conditions](#), on page 550

[Profiler Feed Service](#), on page 689

[Create a Profiler Condition](#), on page 550

Posture Condition Settings

This section describes simple and compound conditions used for posture.

File Condition Settings

The following table describes the fields in the **File Conditions** window. The navigation path for this window is **Policy > Policy Elements > Conditions > Posture > File Condition**.

Table 138: File Condition Settings

| Field Name | Usage Guidelines for Windows OS | Usage Guidelines for macOS |
|-------------------------|---|--|
| Name | Enter the name of the file condition. | Enter the name of the file condition. |
| Description | Enter a description for the file condition. | Enter a description for the file condition. |
| Operating System | Select any Windows operating system to which the file condition should be applied. | Select any macOS to which the file condition should be applied. |
| File Type | <p>Choose one of the predefined settings:</p> <ul style="list-style-type: none"> • FileDate: Checks whether a file with a particular file-created or file-modified date exists in the system. • FileExistence: Checks whether a file exists in the system. • FileVersion: Checks whether a particular version of a file exists in the system. • CRC32: Checks the data integrity of a file using the checksum function. • SHA-256: Checks the data integrity of a file using the hash function. | <p>Choose one of the predefined settings:</p> <ul style="list-style-type: none"> • FileDate: Checks whether a file with a particular file-created or file-modified date exists in the system. • FileExistence: Checks whether a file exists in the system. • CRC32: Checks the data integrity of a file using the checksum function. • SHA-256: Checks the data integrity of a file using the hash function. • PropertyList: Checks the property value in a plist file, such as loginwindow.plist. |

| Field Name | Usage Guidelines for Windows OS | Usage Guidelines for macOS |
|-------------------------------|---------------------------------|--|
| Data Type and Operator | NA | <p>(Available only if you select PropertyList as the File Type)
Choose the data type or value of the key to be searched in the plist files. Each data type contains a set of operators.</p> <ul style="list-style-type: none"> • Unspecified: Checks the existence of the specified key. Enter an Operator (Exists, DoesNotExist). • Number: Checks for the specified key of number data type. Enter an Operator (equals, does not equal, greater than, less than, greater than or equal to, less than or equal to) and a Value. • String: Checks for the specified key of string data type. Enter an Operator (equals, does not equal, equals (ignore case), starts with, does not start with, contains, does not contain, ends with, does not end with) and a Value. • Version: Checks for the value of the specified key as a version string. Enter an Operator (earlier than, later than, same as) and a Value. |
| Property Name | NA | <p>(Available only if you select PropertyList as the File Type)
Enter a name of the key, for example,
BuildVersionStampAsNumber</p> |

| Field Name | Usage Guidelines for Windows OS | Usage Guidelines for macOS |
|-----------------------|---|---|
| File Path | Choose one of the predefined settings: <ul style="list-style-type: none"> • ABSOLUTE_PATH: Checks the file in the fully qualified path of the file. For example, C:\<directory>\file name. For other settings, enter only the file name. • SYSTEM_32: Checks the file in the C:\WINDOWS\system32 directory. Enter the file name. • SYSTEM_DRIVE: Checks the file in the C:\ drive. Enter the file name. • SYSTEM_PROGRAMS: Checks the file in the C:\Program Files. Enter the file name. • SYSTEM_ROOT: Checks the file in the root path for Windows system. Enter the file name. • USER_DESKTOP: Checks if the specified file is present on the Windows user's desktop. Enter the file name. • USER_PROFILE: Checks if the file is present in the Windows user's local profile directory. Enter the file path. | Choose one of the predefined settings: <ul style="list-style-type: none"> • Root: Checks the file in the root (/) directory. Enter the file path. • Home: Checks the file in the home (~) directory. Enter the file path. |
| File Date Type | (Available only if you select FileDate as the File Type) Choose Creation Date or Modification Date . | (Available only if you select FileDate as the File Type) Choose Creation Date or Modification Date . |

| Field Name | Usage Guidelines for Windows OS | Usage Guidelines for macOS |
|--------------------------|--|---|
| File Operator | <p>The File Operator options change according to the settings you select in the File Type. Choose the settings appropriately:</p> <p>FileDate</p> <ul style="list-style-type: none"> • EarlierThan • LaterThan • EqualTo <p>FileExistence</p> <ul style="list-style-type: none"> • Exists • DoesNotExist <p>FileVersion</p> <ul style="list-style-type: none"> • EarlierThan • LaterThan • EqualTo | <p>The File Operator options change according to the settings you select in the File Type. Choose the settings appropriately:</p> <p>FileDate</p> <ul style="list-style-type: none"> • EarlierThan • LaterThan • EqualTo <p>FileExistence</p> <ul style="list-style-type: none"> • Exists • DoesNotExist |
| File CRC Data | (Available only if you select CRC32 as the File Type) You can enter a checksum value, for example, 0x3c37fec3 to check file integrity. The checksum value should start with 0x, a hexadecimal integer. | (Available only if you select CRC32 as the File Type) You can enter a checksum value, for example, 0x3c37fec3 to check file integrity. The checksum value should start with 0x, a hexadecimal integer. |
| File SHA-256 Data | (Available only if you select SHA-256 as the File Type) You can enter a 64-byte hexadecimal hash value to check file integrity. | (Available only if you select SHA-256 as the File Type) You can enter a 64-byte hexadecimal hash value to check file integrity. |
| Date and Time | (Available only if you select FileDate as the File Type) Enter the date and time of the client system in mm/dd/yyyy and hh:mm:ss format. | (Available only if you select FileDate as the File Type) Enter the date and time of the client system in mm/dd/yyyy and hh:mm:ss format. |

Related Topics

[Simple Posture Conditions](#), on page 551

[Compound Posture Conditions](#), on page 552

[Create a Posture Condition](#), on page 790

Firewall Condition Settings

The Firewall condition checks if a specific Firewall product is running on an endpoint. The list of supported Firewall products is based on the OPSWAT support charts. You can enforce policies during initial posture and Periodic Reassessment (PRA).

| Field Name | Usage Guidelines |
|--------------------------|--|
| Name | Enter the name of the Firewall condition. |
| Description | Enter a description for the Firewall condition. |
| Compliance Module | Supports OESIS version 4.x or later. |
| Operating System | Checks If the required Firewall product is installed on an endpoint. You can select the Windows OS or macOS. |
| Vendor | Choose a vendor name from the drop-down list. The Firewall products of a vendor and their check type are retrieved and displayed in the Products for Selected Vendor table. The list in the table changes according to the selected operating system. |
| Check Type | Enabled: To check if a specific Firewall is running on an endpoint. Verify if the vendor's product supports the chosen check type by referring to the Products for Selected Vendor list. |

Registry Condition Settings

The following table describes the fields in the Registry Conditions window. The navigation path for this window is **Policy > Policy Elements > Conditions > Posture > Registry Condition**.

Table 139: Registry Condition Settings

| Field Name | Usage Guidelines |
|--------------------------|---|
| Name | Enter the name of the registry condition. |
| Description | Enter a description for the registry condition. |
| Registry Type | Choose one of the predefined settings as the registry type. |
| Registry Root Key | Choose one of the predefined settings as the registry root key. |

| Field Name | Usage Guidelines |
|-------------------------|---|
| Sub Key | <p>Enter the sub key without the backslash (“\”) to check the registry key in the path specified in the Registry Root Key.</p> <p>For example, SOFTWARE\Symantec\Norton AntiVirus\version will check the key in the following path:</p> <p>HKLM\SOFTWARE\Symantec\NortonAntiVirus\version</p> |
| Value Name | <p>(Available only if you select RegistryValue or RegistryValueDefault as the Registry Type) Enter the name of the registry key value to be checked for RegistryValue.</p> <p>This is the default field for RegistryValueDefault.</p> |
| Value Data Type | <p>(Available only if you select RegistryValue or RegistryValueDefault as the Registry Type) Choose one of the following settings:</p> <ul style="list-style-type: none"> • Unspecified: Checks whether the registry key value exists or not. This option is available only for RegistryValue. • Number: Checks the specified number in the registry key value • String: Checks the string in the registry key value • Version: Checks the version in the registry key value |
| Value Operator | Choose the settings appropriately. |
| Value Data | (Available only if you select RegistryValue or RegistryValueDefault as the Registry Type) Enter the value of the registry key according to the data type you have selected in Value Data Type . |
| Operating System | Select the operating system to which the registry condition should be applied. |

Related Topics

[Simple Posture Conditions](#), on page 551

[Compound Posture Conditions](#), on page 552

Application Condition Settings

The following table describes the fields in the Application Conditions window. The navigation path for this window is: **Policy > Policy Elements > Conditions > Posture > Application Condition**.

Table 140: Application Condition Settings

| Field Name | Usage Guidelines |
|----------------------|--|
| Name | Enter the name of the application condition. |
| Description | Enter a description of the application condition. |
| Operating System | Select the Windows OS or the macOS to which the application condition should be applied. |
| Process Name | Enter the name of the application to be checked. |
| Application Operator | Choose the status to be checked. |

Related Topics

[Simple Posture Conditions](#), on page 551

[Compound Posture Conditions](#), on page 552

Continuous Endpoint Attribute Monitoring

You can use the AnyConnect agent to continuously monitor different endpoint attributes to ensure that dynamic changes are observed during posture assessment. This improves the overall visibility of an endpoint and helps you create posture policies based on their behavior. The AnyConnect agent monitors applications that are installed and running on an endpoint. You can turn on and off the feature and configure how often the data should be monitored. By default, data is collected every 5 minutes and is stored in the database. During initial posture, AnyConnect reports a complete list of running and installed applications. After initial posture, the AnyConnect agent scans the applications every X minute and sends the differences from the last scan to the server. The server displays the complete list of running and installed applications.

Application Condition Settings

The application condition queries for applications that are installed on an endpoint. This helps you to get an aggregate visibility of the software distributed on your endpoints.

| Field Name | Usage Guidelines |
|-------------------|---|
| Name | Enter the name of the application condition. |
| Description | Enter the description for the application condition. |
| Operating System | Select the Windows OS or MAC OSX to which the application condition should be applied. |
| Compliance Module | Choose one of the following options: <ul style="list-style-type: none"> • 4.x or later • 3.x or earlier • Any Version |

| Field Name | Usage Guidelines |
|-----------------------------|--|
| Check By | Choose one of the following options: <ul style="list-style-type: none"> • Process: Choose this option to check if a process is running on an endpoint. • Application: Choose this option to check if an application is running on an endpoint. |
| Process Name | (Available only when you select Process as the Check By option) Enter the required process name. |
| Application Operator | (Available only when you select Process as the Check By option) Choose one of the following options: <ul style="list-style-type: none"> • Running: Choose this option to check if an application is running on an endpoint. • Not Running: Choose this option to check whether an application is not running on an endpoint. |
| Application State | (Available only when you select Application as the Check By option) Choose one of the following options: <ul style="list-style-type: none"> • Installed: Choose this option to check whether the clients have malicious applications installed. If a malicious application is found, the remediation action is triggered. • Running: Choose this option to check if an application is running on an endpoint. |
| Provision By | (Available only when you select Application as the Check By option) Choose one of the following options: <ul style="list-style-type: none"> • Everything: You can select all listed categories such as Browser, Patch Management, and so on. • Name: You should select at least one category. For example, if you choose the Browser category, it displays the corresponding vendors in the Vendor drop-down list. • Category: You can check one or more categories such as Anti-Malware, Backup, Browser, or Data Storage. <p>Note Categories are dynamically updated from the OPSWAT library.</p> |

You can view the number of installed and running applications for each endpoint in the **Context Visibility > Endpoints > Compliance** window.

The **Home > Summary > Compliance** window displays the percentage of endpoints that are subject to posture assessment and are compliant.

Service Condition Settings

The following table describes the fields in the **Service Conditions** window. The navigation path for this window is **Policy > Policy Elements > Conditions > Posture > Service Condition**.

Table 141: Service Conditions Settings

| Field Name | Usage Guidelines |
|--------------------------|--|
| Name | Enter a name for the service condition. |
| Description | Enter a description of the service condition. |
| Operating Systems | Select the operating system to which the service condition should be applied. You can select different versions of the Windows OS or macOS. |
| Service Name | Enter the name of the Daemon or User Agent service, for example, com.apple.geod, running as root. The AnyConnect agent uses the command sudo launchctl list to validate the service condition. |
| Service Type | Choose the type of service that AnyConnect should check for to ensure client compliance: <ul style="list-style-type: none"> • Daemon: Checks if a specified service, such as scanning a client device for malware, is present in the specified list of Daemon services in the client. • User Agent: Checks if a specified service, such as a service that runs when malware is detected, is present in the specified list of User services in the client. • Daemon or User Agent: Checks if the specified services are present either in the Daemon or User Agent services list. |
| Service Operator | Choose the service status that you want to check in the client: <ul style="list-style-type: none"> • Windows OS: To check if a service is Running or Not Running. • Mac OSX: To check if a service is Loaded, Not Loaded, Loaded and Running, Loaded with Exit Code, and Loaded and running or with Exit code. |

Related Topics

[Simple Posture Conditions](#), on page 551

[Compound Posture Conditions](#), on page 552

Posture Compound Condition Settings

The following table describes the fields in the **Compound Conditions** window. The navigation path for this window is **Policy > Policy Elements > Conditions > Posture > Compound Condition**.

Table 142: Posture Compound Condition Settings

| Field Name | Usage Guidelines |
|---|--|
| Name | Enter the name of the compound condition that you want to create. |
| Description | Enter the description of the compound condition that you want to create. |
| Operating System | Select one or more Windows operating systems. This allows you to associate Windows operating systems to which the condition is applied. |
| Parentheses () | Click the parentheses to combine two simple conditions from the following simple condition types: file, registry, application, and service conditions. |
| (&): AND operator (use “&” for an AND operator, without the quotes) | You can use the AND operator (ampersand [&]) in a compound condition. For example, enter Condition1 & Condition2 . |
| (): OR operator (use “ ” for an OR operator, without the quotes) | You can use the OR operator (horizontal bar []) in a compound condition. For example, enter Condition1 & Condition2 . |
| (!): NOT operator (use “!” for a NOT operator, without the quotes) | You can use the NOT operator (exclamation point [!]) in a compound conditions. For example, enter Condition1 & Condition2 . |
| Simple Conditions | <p>Choose from a list of simple conditions of the following types: file, registry, application, and service conditions.</p> <p>You can also create simple conditions of file, registry, application, and service conditions from the object selector.</p> <p>Click the quick picker (down arrow) on the Action button to create simple conditions of file, registry, application, and service conditions.</p> |

Related Topics

[Posture Conditions](#), on page 551

[Create Compound Posture Conditions](#), on page 554

AntiVirus Condition Settings

The following table describes the fields in the **Anti-Virus Condition** window. The navigation path for this window is **Policy > Policy Elements > Conditions > Posture > Anti-Virus Condition**.

Table 143: AntiVirus Condition Settings

| Field Name | Usage Guidelines |
|--|--|
| Name | Enter the name of the antivirus condition that you want to create. |
| Description | Enter the description of the antivirus condition that you want to create. |
| Operating System | Select an operating system to check the installation of an antivirus programs on your client, or check the latest antivirus definition file updates to which the condition is applied. |
| Vendor | Choose a vendor from the drop-down list. The selection of Vendor retrieves their antivirus products and versions, which are displayed in the Products for Selected Vendor table. |
| Check Type | Choose whether to check an installation or check the latest definition file update on the client. |
| Installation | Choose to check only the installation of an antivirus program on the client. |
| Definition | Choose to check only the latest definition file update of an antivirus product on the client. |
| Check against latest AV definition file version, if available | (Available only when you choose Definition check type) Choose to check the antivirus definition file version on the client against the latest antivirus definition file version, if available as a result of posture updates in Cisco ISE. Otherwise, this option allows you to check the definition file date on the client against the latest definition file date in Cisco ISE. |

| Field Name | Usage Guidelines |
|--|--|
| Allow virus definition file to be (Enabled) | <p>(Available only when you choose Definition check type) Choose to check the antivirus definition file version and the latest antivirus definition file date on the client. The latest definition file date cannot be older than that you define in the next field (days older than field) from the latest antivirus definition file date of the product or the current system date.</p> <p>If unchecked, Cisco ISE allows you to check only the version of the antivirus definition file using the Check against latest AV definition file version, if available option.</p> |
| Days Older than | <p>Define the number of days that the latest antivirus definition file date on the client can be older from the latest antivirus definition file date of the product or the current system date. The default value is zero (0).</p> |
| Latest File Date | <p>Choose to check the antivirus definition file date on the client, which can be older by the number of days that you define in the days older than field.</p> <p>If you set the number of days to the default value (0), then the antivirus definition file date on the client should not be older than the latest antivirus definition file date of the product.</p> |
| Current System Date | <p>Choose to check the antivirus definition file date on the client, which can be older by the number of days that you define in the days older than field.</p> <p>If you set the number of days to the default value (0), then the antivirus definition file date on the client should not be older than the current system date.</p> |
| Products for Selected Vendor | <p>Choose an antivirus product from the table. Based on the vendor that you select in the New Anti-virus Condition page, the table retrieves information on their antivirus products and their version, remediation support that they provide, latest definition file date and its version.</p> <p>The selection of a product from the table allows you to check for the installation of an antivirus program, or check for the latest antivirus definition file date, and its latest version.</p> |

Related Topics

[Compound Posture Conditions](#), on page 552

[Preconfigured Antivirus and Antispyware Conditions](#), on page 552

[Antivirus and Antispyware Support Chart](#), on page 553

Antispyware Compound Condition Settings

The following table describes the fields in the **AS Compound Conditions** window. The navigation path for this window is **Policy > Policy Elements > Conditions > AS Compound Condition**.

Table 144: Antispyware Compound Condition Settings

| Field Name | Usage Guidelines |
|--|--|
| Name | Enter the name of the antispyware compound condition that you want to create. |
| Description | Enter the description of the antispyware compound condition that you want to create. |
| Operating System | Selecting an operating system allows you to check the installation of an antispyware program on your client, or check the latest antispyware definition file updates to which the condition is applied. |
| Vendor | Choose a vendor from the drop-down list. The selection of Vendor retrieves their antispyware products and versions, which are displayed in the Products for Selected Vendor table. |
| Check Type | Choose if you want to choose a type whether to check an installation, or check the latest definition file update on the client. |
| Installation | Choose if you want to check only the installation of an antispyware program on the client. |
| Definition | Choose if you want to check only the latest definition file update of an antispyware product on the client. |
| Allow Virus Definition File to be (Enabled) | <p>Check this check box when you are creating antispyware definition check types, and disabled when creating antispyware installation check types.</p> <p>If checked, the selection allows you to check antispyware definition file version and the latest antispyware definition file date on the client. The latest definition file date cannot be older than that you define in the days older than field from the current system date.</p> <p>If unchecked, the selection allows you to check only the version of the antispyware definition file as the Allow virus definition file to be check box is not checked.</p> |
| Days Older than | Define the number of days that the latest antispyware definition file date on the client can be older from the current system date. The default value is zero (0). |

| Field Name | Usage Guidelines |
|-------------------------------------|--|
| Current System Date | Choose to check the antispysware definition file date on the client, which can be older by the number of days that you define in the days older than field.

If you set the number of days to the default value (0), then the antispysware definition file date on the client should not be older than the current system date. |
| Products for Selected Vendor | Choose an antispysware product from the table. Based on the vendor that you select in the New Anti-spyware Compound Condition page, the table retrieves information on their antispysware products and their version, remediation support that they provide, latest definition file date and its version.

The selection of a product from the table allows you to check for the installation of an antispysware program, or check for the latest antispysware definition file date, and its latest version. |

Related Topics

[Compound Posture Conditions](#), on page 552

[Preconfigured Antivirus and Antispysware Conditions](#), on page 552

[Antivirus and Antispysware Support Chart](#), on page 553

Antimalware Condition Settings

The antimalware condition is a combination of the antispysware and antivirus conditions and is supported by OESIS version 4.x or later compliance module.

The following table describes the fields in the **Antimalware Conditions** window. The navigation path is **Work Centers > Posture > Posture Elements > Conditions > Antimalware**. You can also access the option in the **Policy > Policy Elements > Conditions > Posture > Antimalware Condition** window.



Note It is recommended that you manually update the installed Antimalware products to have the latest definitions at least once. Otherwise, the posture checks using AnyConnect for Antimalware definitions might fail.

Table 145: Antimalware Condition Settings

| Field Name | Usage Guidelines |
|--------------------------|---|
| Name | Enter the name of the antimalware condition. |
| Description | Enter a description of the antimalware condition. |
| Compliance Module | Support for OESIS version 4.x or later. |

| Field Name | Usage Guidelines |
|--|---|
| Operating System | Select an operating system to check the installation of antimalware programs on your client, or check the latest antimalware definition file updates to which the condition is applied. It supports both macOS and Windows OS. |
| Vendor | Choose a vendor from the drop-down list. The selected vendor's antimalware products, versions, latest definition dates, latest definition versions, and the minimum compliance module versions, are displayed in the Products for Selected Vendor table. |
| Check Type | Choose whether to check an installation or check the latest definition file update on the client. |
| Installation | Choose this option to check if an antimalware program is installed on the client. |
| Definition | Choose this option to check the latest definition file update of an antimalware product on the client. |
| Check Against Latest AV Definition File Version, if Available | <p>(Available only when you choose Definition check type) Choose to check the antimalware definition file version on the client against the latest antimalware definition file version, if available as a result of posture updates in Cisco ISE. Otherwise, this option allows you to check the definition file date on the client against the latest definition file date in Cisco ISE.</p> <p>This check will only work if there is a value listed in Cisco ISE for the Latest Definition Date or Latest Definition Version field for the selected product. Otherwise, the Current System Date field must be used.</p> |
| Allow Virus Definition File to be (Enabled) | <p>(Available only when you choose Definition check type) Choose to check the antimalware definition file version and the latest antimalware definition file date on the client. The latest definition file date cannot be older than that you define in the next field (days older than field) from the latest antimalware definition file date of the product or the current system date.</p> <p>If unchecked, Cisco ISE allows you to check only the version of the antimalware definition file using the Check against latest AV definition file version, if available option.</p> |

| Field Name | Usage Guidelines |
|-------------------------------------|--|
| Days Older Than | Define the number of days that the latest antimalware definition file date on the client can be older from the latest antimalware definition file date of the product or the current system date. The default value is zero (0). |
| Latest File Date | <p>Choose to check the antimalware definition file date on the client, which can be older by the number of days that you define in the days older than field.</p> <p>If you set the number of days to the default value (0), then the antimalware definition file date on the client should not be older than the latest antimalware definition file date of the product.</p> <p>This check works only if there is a value listed in Cisco ISE for the Latest Definition Date field for the selected product. Otherwise, the Current System Date field must be used.</p> |
| Current System Date | <p>Choose to check the antimalware definition file date on the client, which can be older by the number of days that you define in the days older than field.</p> <p>If you set the number of days to the default value (0), then the antimalware definition file date on the client should not be older than the current system date.</p> |
| Products for Selected Vendor | <p>Choose an antimalware product from the table. Based on the vendor that you select in the New Antimalware Condition page, the table retrieves information on their antimalware products and their version, remediation support that they provide, latest definition file date and its version.</p> <p>The selection of a product from the table allows you to check for the installation of an antimalware program, or check for the latest antimalware definition file date, and its latest version.</p> |

Related Topics

[Compound Posture Conditions](#), on page 552

Dictionary Simple Condition Settings

The following table describes the fields in the **Dictionary Simple Conditions** window. The navigation path for this window is **Policy > Policy Elements > Conditions > Posture > Dictionary Simple Condition**.

Table 146: Dictionary Simple Condition Settings

| Field Name | Usage Guidelines |
|--------------------|---|
| Name | Enter the name of the dictionary simple condition that you want to create. |
| Description | Enter the description of the dictionary simple condition that you want to create. |
| Attribute | Choose an attribute from the dictionary. |
| Operator | Choose an operator to associate a value to the attribute that you have selected. |
| Value | Enter a value that you want to associate to the dictionary attribute, or choose a predefined value from the drop-down list. |

Related Topics

[Simple Posture Conditions](#), on page 551

[Create Simple Posture Conditions](#), on page 552

Dictionary Compound Condition Settings

The following table describes the fields in the **Dictionary Compound Conditions** window. The navigation path for this window is **Policy > Policy Elements > Conditions > Posture > Dictionary Compound Condition**.

Table 147: Dictionary Compound Condition Settings

| Field Name | Usage Guidelines |
|---|---|
| Name | Enter the name of the dictionary compound condition that you want to create. |
| Description | Enter the description of the dictionary compound condition that you want to create. |
| Select Existing Condition from Library | Define an expression by selecting pre-defined conditions from the policy elements library or add ad-hoc attribute/value pairs to your expression in the subsequent steps. |
| Condition Name | Choose dictionary simple conditions that you have already created from the policy elements library. |
| Expression | The Expression is updated based on your selection from the Condition Name drop-down list. |

| Field Name | Usage Guidelines |
|--|---|
| AND or OR operator | Choose an AND, or an OR operator to logically combine dictionary simple conditions, which can be added from the library.

Click the Action icon to do the following: <ul style="list-style-type: none"> • Add Attribute/Value • Add Condition from Library • Delete |
| Create New Condition (Advance Option) | Select attributes from various system or user-defined dictionaries.

You can also add predefined conditions from the policy elements library in the subsequent steps. |
| Condition Name | Choose a dictionary simple condition that you have already created. |
| Expression | From the Expression drop-down list, you can create a dictionary simple condition. |
| Operator | Choose an operator to associate a value to an attribute. |
| Value | Enter a value that you want to associate to the dictionary attribute, or choose a value from the drop-down list. |

Related Topics

[Compound Posture Conditions](#), on page 552

[Create Compound Posture Conditions](#), on page 554

Patch Management Condition Settings


The following table describes the fields in the **Patch Management Conditions** window. The navigation path is To view this window, click the **Menu** icon () and choose **Policy > Policy Elements > Conditions > Posture > Patch Management Condition**.

Table 148: Patch Management Condition

| Field Name | Usage Guidelines |
|--------------------|---|
| Name | Enter the name of the patch management condition. |
| Description | Enter a description for the patch management condition. |

| Field Name | Usage Guidelines |
|-------------------------|--|
| Operating System | Choose an operating system to check the installation of a patch management software on the endpoint, or check the latest patch management definition file updates to which the condition is applied. You can select the Windows OS or macOS. You can also select more than one version of an operating system to create the patch management condition. |
| Vendor Name | Choose a vendor from the Vendor Name drop-down list. Based on your selection, the patch management products and their supported versions, check type, and minimum compliant module support details are displayed in the Products for Selected Vendor table. The list in the table changes according to the selected operating system. |
| Check Type | <p>Choose one of the following options:</p> <ul style="list-style-type: none"> • Installation: To check if the selected product is installed on the endpoint. This check type is supported by all vendors. • Enabled: To check if the selected product is enabled on the endpoint. Verify if the vendor's product supports the chosen check type by referring to the Products for Selected Vendor list. • Up to Date: To check if the selected product does not have missing patches. Verify if the vendor's product supports the chosen check type by referring to the Products for Selected Vendor list. <p>Click the Products for Selected Vendor drop-down list to view the list of products that the vendor you have specified in the Vendor Name field supports. For example, if you have selected Vendor A that has two products, namely Product 1 and Product 2. Product 1 may support the Enabled option, whereas Product 2 might not. Or, if Product 1 does not support any of the check types, it is grayed out.</p> |

Related Topics

[Create Patch Management Conditions](#), on page 555

Disk Encryption Condition Settings

The following table describes the fields in the **Disk Encryption Condition** window. The navigation path is **Policy > Policy Elements > Conditions > Posture > Disk Encryption Condition**.

Table 149: Disk Encryption Condition Settings

| Field Name | Usage Guidelines |
|-------------------------|--|
| Name | Enter the name of the disk encryption condition that you want to create. |
| Description | Enter a description for the disk encryption condition. |
| Operating System | Select an operating system of the end point, whose disk is to be checked for encryption. You can select the Windows OS or macOS. You can also select more than one version of an operating system to create the disk encryption condition. |
| Vendor Name | Choose a vendor name from the drop-down list. The data encryption products of a vendor, and their supported version, the encryption state check, and the minimum compliant module support are retrieved and displayed in the Products for Selected Vendor table. The list in the table changes according to the selected operating system. |
| Location | <p>Enabled only when an option is checked in the Products for Selected Vendor section. Select any one of the following options:</p> <ul style="list-style-type: none"> • Specific Location: To check if the specified disk drive is encrypted in the end point, (for example, C: for Windows OS) or a specified volume label is encrypted, (for example, Mackintosh HD for macOS). • System Location: To check if the default Windows OS system drive or macOS hard drive is encrypted in the end point. |
| Encryption State | <p>The Encryption State checkbox is disabled when the selected product does not support encryption state check. The repeater is displayed only when the checkbox is checked. You can select the Fully Encrypted option to check if the client's disk drive is wholly encrypted.</p> <p>If you create a condition, for example for TrendMicro, and select two vendors—one with the Encryption State "Yes" and another with the Encryption State "No", then the Encryption State will be disabled because one of the Vendor Encryption States is "No".</p> <p>Note You can click the repeater to add more Locations and the relationship between each location is the logical AND operator.</p> |

Related Topics

[Create Disk Encryption Conditions](#), on page 556

USB Condition Settings

The following table describes the fields in the **USB Condition** window. The navigation path is **Work Centers > Posture > Policy Elements > USB**. You can also navigate to the **Policy > Policy Elements > Conditions > Posture > USB Condition** window.

The USB check is a predefined condition and supports only Windows OS.

Table 150: USB Condition Settings

| Field Name | Usage Guidelines |
|-------------------|---|
| Name | USB_Check |
| Description | Cisco predefined check |
| Operating System | Windows |
| Compliance Module | A display-only field for ISE posture compliance module support for version 4.x (and later). |

Related Topics

[Simple Posture Conditions](#), on page 551

Time and Date Condition Settings

The following table describes the fields in the **Time and Date Conditions** window. The navigation path for this window is **Policy > Policy Elements > Conditions > Common > Time and Date**.

Table 151: Time and Date Condition Settings

| Field Name | Usage Guidelines |
|--------------------------|--|
| Condition Name | Enter the name of the time and date condition. |
| Description | Enter a description of the time and date condition. |
| Standard Settings | |
| All Day | (Default) Set for the entire day. |
| Specific Hours | Configure hours, minutes, and AM/PM to set a to-and-from time range. |
| Every Day | (Default) Set for every day. |
| Specific Days | Configure one or more specific days of the week. |
| No Start and End Dates | (Default) Set with no start or end date. |

| Field Name | Usage Guidelines |
|---------------------|---|
| Specific Date Range | Configure the month, day, and year to set a to-and-from date range. |
| Specific Date | Configure a specific month, day, and year. |
| Exceptions | |
| Time Range | Configure the hours, minutes, and AM/PM to set a to-and-from time range. |
| Week Days | Configure one or more specific days of the week. |
| Date Range | Choose on the following two options: <ul style="list-style-type: none"> • Specific Date Range: Provides drop-down lists you can use to configure a specific to-and-from date range by month, day, and year. • Specific Date: Provides drop-down lists you can use to configure a specific month, day, and year. |

Related Topics

[Time and Date Conditions](#), on page 607

[Create Time and Date Conditions](#), on page 558

Results

This section describes requirements for Cisco ISE services.

Allowed Protocols

The following table describes the fields in the **Allowed Protocols** window, which allows you to configure the protocols to be used during authentication. The navigation path is **Policy > Policy Elements > Results > Authentication > Allowed Protocols**.

Table 152: Allowed Protocols

| Field Name | Usage Guidelines |
|---|------------------|
| Allowed Protocols > Authentication Bypass | |

| Field Name | Usage Guidelines |
|--|--|
| Process Host Lookup | <p>Check this check box if you want Cisco ISE to process the Host Lookup request. The Host Lookup request is processed for PAP/CHAP protocol when the RADIUS Service-Type equals 10 (Call-Check) and the username is equal to Calling-Station-ID. The Host Lookup request is processed for EAP-MD5 protocol when the Service-Type equals 1 (Framed) and the username is equal to Calling-Station-ID. Uncheck this check box if you want Cisco ISE to ignore the Host Lookup request and use the original value of the system username attribute for authentication. When unchecked, message processing is done according to the protocol (for example, PAP).</p> <p>Note Disabling this option could result in the failure of existing MAB authentications.</p> |
| Allowed Protocols > Authentication Protocols | |
| Allow PAP/ASCII | This option enables PAP/ASCII. PAP uses cleartext passwords (that is, unencrypted passwords) and is the least secure authentication protocol. |
| Allow CHAP | This option enables CHAP authentication. CHAP uses a challenge-response mechanism with password encryption. CHAP does not work with Microsoft Active Directory. |
| Allow MS-CHAPv1 | Check this check box to enable MS-CHAPv1. |
| Allow MS-CHAPv2 | Check this check box to enable MS-CHAPv2. |
| Allow EAP-MD5 | Check this check box to enable EAP-based MD5 password hashed authentication. |

| Field Name | Usage Guidelines |
|-----------------------------|--|
| <p>Allow EAP-TLS</p> | <p>Check this check box to enable EAP-TLS Authentication protocol and configures EAP-TLS settings. You can specify how Cisco ISE will verify the user identity as presented in the EAP identity response from the end-user client. User identity is verified against information in the certificate that the end-user client presents. This comparison occurs after an EAP-TLS tunnel is established between Cisco ISE and the end-user client.</p> <p>Note EAP-TLS is a certificate-based authentication protocol. EAP-TLS authentication can occur only after you have completed the required steps to configure certificates.</p> <ul style="list-style-type: none"> • Allow authentication of expired certificates to allow certificate renewal in Authorization Policy: Check this check box, if you want to allow users to renew certificates. If you check this check box, ensure that you configure appropriate authorization policy rules to check if the certificate has been renewed before processing the request any further. • Enable Stateless Session Resume: Check this check box to allow EAP-TLS session resumption without requiring the session state to be stored at the server. Cisco ISE supports session ticket extension as described in RFC 5077. Cisco ISE creates a ticket and sends it to an EAP-TLS client. The client presents the ticket to ISE to resume a session. • Proactive Session Ticket update: Enter the value as a percentage to indicate how much of the Time To Live (TTL) must elapse before the session ticket is updated. For example, if you enter the value 60, the session ticket is updated after 60 percent of the TTL has expired. • Session ticket Time to Live: Enter the time after which the session ticket expires. This value determines the duration that a session ticket remains active. You can enter the value in seconds, minutes, hours, days, or weeks. |
| <p>Allow LEAP</p> | <p>Check this check box to enable Lightweight Extensible Authentication Protocol (LEAP) authentication.</p> |

| Field Name | Usage Guidelines |
|------------|------------------|
| Allow PEAP | |

| Field Name | Usage Guidelines |
|------------|--|
| | <p>Check this check box to enable PEAP authentication protocol and PEAP settings. The default inner method is MS-CHAPv2.</p> <p>When you check the Allow PEAP check box, you can configure the following PEAP inner methods:</p> <ul style="list-style-type: none"> • Allow EAP-MS-CHAPv2: Check this check box to use EAP-MS-CHAPv2 as the inner method. <ul style="list-style-type: none"> • Allow Password Change: Check this check box for Cisco ISE to support password changes. • Retry Attempts: Specifies how many times Cisco ISE requests user credentials before returning login failure. Valid values are 0 to 3. • Allow EAP-GTC: Check this check box to use EAP-GTC as the inner method. <ul style="list-style-type: none"> • Allow Password Change: Check this check box for Cisco ISE to support password changes. • Retry Attempts: Specifies how many times Cisco ISE requests user credentials before returning login failure. The valid range is from 0 to 3. • Allow EAP-TLS: Check this check box to use EAP-TLS as the inner method. <p>Check the Allow authentication of expired certificates to allow certificate renewal in Authorization Policy check box, if you want to allow users to renew certificates. If you check this check box, ensure that you configure appropriate authorization policy rules to check if the certificate has been renewed before processing the request any further.</p> • Require Cryptobinding TLV: Check this check box if you want both the EAP peer and the EAP server to participate in the inner and outer EAP authentications of the PEAP authentication. • Allow PEAPv0 Only for Legacy Clients: Check this check box to allow PEAP supplicants to negotiate using PEAPv0. Some legacy clients do not conform to the PEAPv1 protocol standards. |

| Field Name | Usage Guidelines |
|------------|---|
| | To ensure that such PEAP conversations are not dropped, check this check box. |

| Field Name | Usage Guidelines |
|----------------|------------------|
| Allow EAP-FAST | |

| Field Name | Usage Guidelines |
|------------|--|
| | <p>Check this check box to enable EAP-FAST authentication protocol and EAP-FAST settings. The EAP-FAST protocol can support multiple internal protocols on the same server. The default inner method is MS-CHAPv2.</p> <p>When you check the Allow EAP-FAST check box, you can configure EAP-FAST as the inner method:</p> <ul style="list-style-type: none"> • Allow EAP-MS-CHAPv2 <ul style="list-style-type: none"> • Allow Password Change: Check this check box for Cisco ISE to support password changes. • Retry Attempts: Specifies how many times Cisco ISE requests user credentials before returning login failure. Valid values are 0-3. • Allow EAP-GTC <ul style="list-style-type: none"> Allow Password Change: Check this check box for Cisco ISE to support password changes. Retry Attempts: Specifies how many times Cisco ISE requests user credentials before returning login failure. Valid values are 0-3. • Use PACs: Choose this option to configure Cisco ISE to provision authorization Protected Access Credentials (PAC) for EAP-FAST clients. Additional PAC options appear. • Don't Use PACs: Choose this option to configure Cisco ISE to use EAP-FAST without issuing or accepting any tunnel or machine PACs. All requests for PACs are ignored and Cisco ISE responds with a Success-TLV without a PAC. <ul style="list-style-type: none"> When you choose this option, you can configure Cisco ISE to perform machine authentication. • Allow EAP-TLS: Check this check box to use EAP-TLS as the inner method. <p>Check the Allow authentication of expired certificates to allow certificate renewal in Authorization Policy check box, if you want to allow users to renew certificates. If you check this check box, ensure that you configure appropriate authorization policy rules to check if the certificate has been renewed before processing the request any further.</p> |

| Field Name | Usage Guidelines |
|------------|--|
| | <ul style="list-style-type: none"> • Enable EAP Chaining: Check this check box to enable EAP chaining. <p>EAP chaining allows Cisco ISE to correlate the results of user and machine authentication and apply the appropriate authorization policy using the EAPChainingResult attribute.</p> <p>EAP chaining requires a supplicant that supports EAP chaining on the client device. Choose the User and Machine Authentication option in the supplicant.</p> <p>EAP chaining is available when you choose the EAP-FAST protocol (both in PAC based and PAC less mode).</p> <p>For PAC-based authentication, you can use user authorization PAC or machine authorization PAC, or both to skip the inner method.</p> <p>For certificate-based authentication, if you enable the Accept Client Certificate for Provisioning option for the EAP-FAST protocol (in the Allowed Protocol service), and if the endpoint (AnyConnect) is configured to send the user certificate inside the tunnel, then during tunnel establishment, ISE authenticates the user using the certificate (the inner method is skipped), and machine authentication is done through the inner method. If these options are not configured, EAP-TLS is used as the inner method for user authentication.</p> <p>After you enable EAP chaining, update your authorization policy and add a condition using the NetworkAccess:EapChainingResult attribute and assign appropriate permissions.</p> |

| Field Name | Usage Guidelines |
|-------------------------------|---|
| Allow EAP-TTLS | <p>Check this check box to enable EAP-TTLS protocol.</p> <p>You can configure the following inner methods:</p> <ul style="list-style-type: none"> • Allow PAP/ASCII: Check this check box to use PAP/ASCII as the inner method. You can use EAP-TTLS PAP for token and OTP-based authentications. • Allow CHAP: Check this check box to use CHAP as the inner method. CHAP uses a challenge-response mechanism with password encryption. CHAP does not work with Microsoft Active Directory. • Allow MS-CHAPv1: Check this check box to use MS-CHAPv1 as the inner method. • Allow MS-CHAPv2: Check this check box to use MS-CHAPv2 as the inner method. • Allow EAP-MD5: Check this check box to use EAP-MD5 as the inner method. • Allow EAP-MS-CHAPv2: Check this check box to use EAP-MS-CHAPv2 as the inner method. <ul style="list-style-type: none"> • Allow Password Change: Check this check box for Cisco ISE to support password changes. • Retry Attempts: Specifies how many times Cisco ISE requests user credentials before returning login failure. Valid values are 0 to 3. |
| Preferred EAP Protocol | <p>Check this check box to choose your preferred EAP protocols from any of the following options: EAP-FAST, PEAP, LEAP, EAP-TLS, EAP-TTLS, and EAP-MD5. If you do not specify the preferred protocol, EAP-TLS is used by default.</p> |
| EAP-TLS L-bit | <p>Check this check box to support legacy EAP supplicants that expect length-included flag (L-bit flag) by default in TLS Change Cipher Spec message and Encrypted Handshake message from ISE.</p> |

| Field Name | Usage Guidelines |
|--|---|
| Allow Weak Ciphers for EAP | <p>If this option is enabled, legacy clients are allowed to negotiate using weak ciphers (such as RSA_RC4_128_SHA, RSA_RC4_128_MD5). We recommend that you enable this option only if your legacy clients support only weak ciphers.</p> <p>This option is disabled by default.</p> <p>Note Cisco ISE does not support EDH_RSA_DES_64_CBC_SHA and EDH_DSS_DES_64_CBC_SHA.</p> |
| Require Message Authenticator for all RADIUS Requests | <p>If this option is enabled, Cisco ISE verifies whether the RADIUS Message Authenticator attribute is present in the RADIUS message. If the message authenticator attribute is not present, the RADIUS message is discarded.</p> <p>Enabling this option provides protection from spoofed Access-Request messages and RADIUS message tampering.</p> <p>The RADIUS Message Authenticator attribute is a Message Digest 5 (MD5) hash of the entire RADIUS message.</p> <p>Note EAP uses the Message Authenticator attribute by default and does not require that you enable it.</p> |
| Allow 5G | <p>Check this check box to enable Cisco Private 5G in Cisco ISE.</p> <p>Note You must already have Cisco Private 5G deployed in your network, prior to enabling 5G as a Service (5GaaS) in Cisco ISE</p> |

Related Topics

[Allowed Protocols in FIPS and Non-FIPS Modes for TACACS+ Device Administration](#) , on page 204
[Define Allowed Protocols for Network Access](#), on page 576

PAC Options

The following table describes the fields after you select Use PACs in the **Allowed Protocols Services List** window. The navigation path for this window is **Policy > Policy Elements > Results > Authentication > Allowed Protocols**.

Table 153: PAC Options

| Field Name | Usage Guidelines |
|------------|------------------|
| Use PAC | |

| Field Name | Usage Guidelines |
|------------|---|
| | <ul style="list-style-type: none"> • Tunnel PAC Time To Live: The Time to Live (TTL) value restricts the lifetime of the PAC. Specify the lifetime value and units. The default is 90 days. The range is between 1 and 1825 days. • Proactive PAC Update When: <n%> of PAC TTL is Left: The Update value ensures that the client has a valid PAC. Cisco ISE initiates an update after the first successful authentication but before the expiration time that is set by the TTL. The update value is a percentage of the remaining time in the TTL. The default is 90%. • Allow Anonymous In-band PAC Provisioning: Check this check box for Cisco ISE to establish a secure anonymous TLS handshake with the client and provision it with a PAC by using phase zero of EAP-FAST with EAP-MSCHAPv2. To enable anonymous PAC provisioning, you must choose both of the inner methods, EAP-MSCHAPv2 and EAP-GTC. • Allow Authenticated In-band PAC Provisioning: Cisco ISE uses SSL server-side authentication to provision the client with a PAC during phase zero of EAP-FAST. This option is more secure than anonymous provisioning but requires that a server certificate and a trusted root CA be installed on Cisco ISE.

When you check this option, you can configure Cisco ISE to return an Access-Accept message to the client after successful authenticated PAC provisioning. <ul style="list-style-type: none"> • Server Returns Access Accept After Authenticated Provisioning: Check this check box if you want Cisco ISE to return an access-accept package after authenticated PAC provisioning. • Allow Machine Authenticatio: Check this check box for Cisco ISE to provision an end-user client with a machine PAC and perform machine authentication (for end-user clients who do not have the machine credentials). The machine PAC can be provisioned to the client by request (in-band) or by the administrator (out-of-band). When Cisco ISE receives a valid machine PAC from the end-user client, the machine identity |

| Field Name | Usage Guidelines |
|------------|---|
| | <p>details are extracted from the PAC and verified in the Cisco ISE external identity source. Cisco ISE only supports Active Directory as an external identity source for machine authentication. After these details are correctly verified, no further authentication is performed.</p> <p>When you check this option, you can enter a value for the amount of time that a machine PAC is acceptable for use. When Cisco ISE receives an expired machine PAC, it automatically reprovisions the end-user client with a new machine PAC (without waiting for a new machine PAC request from the end-user client).</p> <ul style="list-style-type: none"> • Enable Stateless Session Resume: Check this check box for Cisco ISE to provision authorization PACs for EAP-FAST clients and skip phase two of EAP-FAST (default = enabled). <p>Uncheck this check box in the following cases:</p> <ul style="list-style-type: none"> • If you do not want Cisco ISE to provision authorization PACs for EAP-FAST clients • To always perform phase two of EAP-FAST <p>When you check this option, you can enter the authorization period of the user authorization PAC. After this period, the PAC expires. When Cisco ISE receives an expired authorization PAC, it performs phase two EAP-FAST authentication.</p> |

Related Topics

[OOB TrustSec PAC](#), on page 800

[Generate the PAC for EAP-FAST](#), on page 572

Authorization Profile Settings

The following fields in the **Authorization Profiles** window define attributes for network access. The navigation path for this window is **Policy > Policy Elements > Results > Authorization > Authorization Profiles**.

Authorization Profile Settings

- **Name:** Enter a name for this new authorization profile.
- **Description:** Enter a description for this authorization profile.
- **Access Type:** Choose the access type: **ACCESS_ACCEPT** or **ACCESS_REJECT**.

- **Service Template:** Enable this option to support sessions with SAnet-capable devices. Cisco ISE implements service templates in authorization profiles using a special flag that marks them as *Service Template* compatible. Since the service template is also an authorization profile, it acts as a single policy that supports both SAnet and non-SAnet devices.
- **Track Movement:** Enable this option to track user location with Cisco Mobility Services Engine (MSE).



Note This option may impact Cisco ISE performance, it is only intended for high-security locations.

- **Passive Identity Tracking:** Enable this option to use the Easy Connect feature of Passive Identity for policy enforcement and user tracking.

Common Tasks

Common tasks are specific permissions and actions that apply to network access.

- **DACL Name :** Enable this option to use a downloadable ACL. You can use the default values (**PERMIT_ALL_TRAFFIC** or **DENY_ALL_TRAFFIC**), or select an attribute from the following dictionaries:
 - External identity store (attributes)
 - Endpoints
 - Internal User
 - Internal Endpoint

For more information about adding DACLs or editing and managing existing DACLs, see [Downloadable ACLs, on page 610](#).

- **Security Group:** Enable this option to assign a security group (SGT) part of authorization.
 - If Cisco ISE is not integrated with Cisco DNA Center, Cisco ISE assigns VLAN ID 1.
 - If Cisco ISE is integrated with Cisco DNA Center, then select the Virtual Network (VN) that Cisco DNA Center shared with Cisco ISE, select the **Data Type**, and the subnet/address pool.



Note A Security Group task includes a security group and an optional VN. If you configure a security group, then you cannot configure a VLAN separately. An endpoint device can only be assigned to one virtual network.

- **VLAN:** Enable this option to specify a virtual LAN (VLAN) ID. You can enter integer or string values for the VLAN ID. The format for this entry is `Tunnel-Private-Group-ID:VLANnumber`.
- **Voice Domain Permission :** Enable this option to use a downloadable ACL. The vendor-specific attribute (VSA) of `cisco-av-pair` is associated with the value `device-traffic-class=voice`. In multidomain authorization mode, if the network switch receives this VSA, the endpoint connects to a voice domain after authorization.

- **Web Redirection (CWA, DRW, MDM, NSP, CPP):** Enable this option to enable web redirection after authentication.

- Select the type of redirection. The type of Web Redirection that you select displays additional options, which are described below.
- Enter an ACL to support the redirection that Cisco ISE sends to the NAD.

The ACL you enter to send to the NAD displays in the **Attributes Details** pane as a cisco-av pair. For example, if you enter **acl119**, it is displayed in the **Attributes Details** pane as: `cisco-av-pair = url-redirect-acl = acl119`.

- Select the other settings for the selected web redirection type.

Select one of the following types web redirection:

- **Centralized Web Auth:** Redirect to the portal you select from the **Value** drop-down.
- **Client Provisioning (Posture):** Redirect to the client provisioning portal you select from the **Value** drop-down, to enable posture on the client.
- **Hot Spot: Redirect:** Redirect to the hot spot portal you select from the **Value** drop-down.
- **MDM Redirect:** Redirect to the MDM portal on the MDM server that you specify.
- **Native Supplicant Provisioning:** Redirect to the BYOD portal you select from the **Value** drop-down.

After selecting the web redirection type, and entering the required parameters, configure the following options:

- **Display Certificates Renewal Message:** Enable this option to display a certificate renewal message. The URL-redirect attribute value changes and includes the number of days for which the certificate is valid. This option is only for Centralized Web Auth redirection.
- **Static IP/Host Name/FQDN:** Enable this option to redirect a user to a different PSN. Enter the target IP address, hostname, or FQDN. If you do not configure this option, the user is redirected to the FQDN of the policy service node that received this request.
- **Suppress Profiler CoA for endpoints in Logical Profile:** Enable this option to cancel the redirect for a certain type of endpoint device.
- **Auto SmartPort:** Enable this option to use Auto SmartPort functionality. Enter an event name, which creates a VSA cisco-av-pair with that value as `auto-smart-port=event_name`. This value is displayed in the **Attributes Details** pane.
- **Access Vulnerabilities:** Enable this option to run the Threat Centric NAC Vulnerability Assessment on this endpoint as part of authorization. Select the adapter, and when to run the scan.
- **Reauthentication:** Enable this option to keep the endpoint connected during reauthentication. You choose to maintain connectivity during reauthentication by choosing to use **RADIUS-Request (1)**. The default RADIUS-Request (0) disconnects the existing session. You can also set an inactivity timer.
- **MACSec Policy:** Enable this option to use the MACSec encryption policy whenever a MACSec enabled client connects to Cisco ISE. Choose one of the following options: **must-secure**, **should-secure**, or **must-not-secure**. Your settings are displayed in the **Attributes Details** pane as: `cisco-av-pair = linksec-policy=must-secure`.

- **NEAT** : Enable this option to use Network Edge Access Topology (NEAT), which extends identity recognition between networks. Checking this check box displays `cisco-av-pair = device-traffic-class=switch` in the **Attributes Details** pane.
- **Web Authentication (Local Web Auth)** : Enable this option to use local web authentication for this authorization profile. This value lets the switch recognize authorization for web authentication by Cisco ISE sending a VSA along with a DACL. The VSA is `cisco-av-pair = priv-lvl=15`, which is displayed in the **Attributes Details** pane.
- **Airespace ACL Name**: Enable this option to send an ACL name to Cisco Airespace wireless controller. The Airespace VSA uses this ACL to authorize a locally defined ACL to a connection on the WLC. For example, if you entered **rsa-1188**, it is displayed as `Airespace-ACL-Name = rsa-1188` in the **Attributes Details** pane.
- **ASA VPN**: Enable this option to assign an Adaptive Security Appliances (ASA) VPN group policy. From the drop-down list, choose a VPN group policy.
- **AVC Profile Name**: Enable this option to run application visibility on this endpoint. Enter the AVC profile to use.

Advanced Attributes Settings

- **Dictionaries**: Click the down arrow icon to view the available options in the **Dictionaries** window. Select a dictionary and an attribute that should be configured in the first field.
- **Attribute Values**: Click the down-arrow icon to display the available options in the **Attribute Values** window. Select the desired attribute group and the attribute value. This value is matched with the one selected in the first field. The **Advanced Attributes** settings that you configure are displayed in the **Attribute Details** panel.
- **Attributes Details**: This pane displays the configured attribute values that you have set for **Common Tasks** and **Advanced Attributes**.

The values that are displayed in the **Attributes Details** pane are read-only.



Note To modify or delete any of the read-only values that are displayed in the **Attributes Details** pane, modify or delete these values in the corresponding **Common Tasks** field, or in the attribute that you selected in the **Attribute Values** field in the **Advanced Attributes Settings** pane.

Related Topics

- [Cisco ISE Authorization Profiles](#), on page 597
- [Permissions for Authorization Profiles](#), on page 609
- [Configure an Authorization Profile for Redirecting Nonregistered Devices](#), on page 260
- [Create Authorization Profiles](#), on page 462

Profiling Exception Action Settings

The following table describes the fields in the **Profiler Exception Actions** window. The navigation path for this window is **Policy > Policy Elements > Results > Profiling > Exception Actions**.

Table 154: Creating an Exception Action

| Field Name | Usage Guidelines |
|----------------------------------|--|
| Name | Enter the name of the exception action that you want to create. |
| Description | Enter the description of the exception action that you want to create. |
| CoA Action to enforce CoA | Check the CoA Action check box to enforce CoA.

When you associate an exception action in the endpoint profiling policy and enforce a CoA, you must configure CoA globally in Cisco ISE that can be done in the following location: Administration > System > Settings > Profiling. |
| Policy Assignment | Click the Policy Assignment drop-down list that displays endpoint profiling policies that are configured in Cisco ISE, and choose the profiling policy against which the endpoint will be profiled when the exception action is triggered, regardless of its matched value. |
| System Type | Exception Actions can be any one of the following types: <ul style="list-style-type: none"> • Cisco Provided: Includes AuthorizationChange, EndpointDelete, and FirstTimeProfile • Administrator Created: Includes that are created by you as an administrator of Cisco ISE. |

Related Topics

[Profiling Exception Actions](#), on page 680

[Create Exception Actions](#), on page 680

File Remediation

The following table describes the fields in the **File Remediation** window. The navigation path is **Policy > Policy Elements > Results > Posture > Remediation Actions > File Remediation**.

Table 155: File Remediation

| Field Name | Usage Guidelines |
|-------------------------------------|--|
| File Remediation Name | Enter a name for the file remediation. Once created and saved, you cannot edit the name of the file remediation. |
| File Remediation Description | Enter a description for the file remediation. |

| Field Name | Usage Guidelines |
|----------------|--|
| Version | Enter the file version. |
| File to Upload | Click Browse to locate the name of the file to be uploaded to the Cisco ISE server. This is the file that will be downloaded to the client when the file remediation action is triggered. |

Related Topics

[Add a File Remediation](#), on page 777

Firewall Remediations

The following table describes the fields on the **Firewall Remediation** window. The navigation path is **Policy > Policy Elements > Results > Posture > Remediation Actions > Firewall Remediations**.

Table 156: Firewall Remediations

| Field Name | Usage Guidelines |
|-----------------------|--|
| Name | Enter a name for the Firewall remediation. |
| Description | Enter the description for the Firewall remediation. |
| Operating System | Choose the Windows OS or Mac OSX. |
| Compliance Module | Support for OESIS version 4.x or later. |
| Remediation Type | Choose one of the following: <ul style="list-style-type: none"> • Automatic: Enter values for the Interval and Retry Count. The ISE server identifies noncompliant clients and selects a remediation notification method and automatically updates the Firewall application on the client. • Manual: (Interval and Retry Count fields are disabled) Noncompliant clients should manually download and apply the latest Firewall application. |
| Interval (in seconds) | (Available only when you select the Automatic remediation type) Enter the time interval in seconds after which a scheduled patch update on the client is performed. Valid range is 0 to 9999. |
| Retry Count | (Available only when you select the Automatic remediation type) Enter the number of times that a client can attempt to update critical patches. Valid range is 0 to 99. |

| Field Name | Usage Guidelines |
|---------------------------|---|
| Vendor Name | <p>Choose a vendor name (for example, VMware Inc.) from the drop-down list.</p> <p>Note Supported versions of Cisco ISE and AnyConnect:</p> <ul style="list-style-type: none"> • Cisco ISE version 2.2 and later • AnyConnect version 4.4 and later |
| Remediation Option | <p>Enable: Enables the Firewall application (if the vendor supports the enable option), in case it is disabled on the endpoint.</p> <p>Click the Products for Selected Vendor drop-down arrow, to view the list of products (for example, VMware vCentre Protect Agent), Version (for example, 8.x), and Enabled Remediation Support (for example, Yes) that the vendor you have specified in the Vendor Name supports. For example, if you have selected Vendor A, that has two products, namely Product 1 and Product 2. Product 1 may support the Enable remediation option, whereas Product 2 might not. The Products for Selected Vendor table changes according to the selected remediation option.</p> |

Link Remediation

The following table describes the fields in the **Link Remediation** window. The navigation path is **Policy > Policy Elements > Results > Posture > Remediation Actions > Link Remediation**.

Table 157: Link Remediation

| Field Name | Usage Guidelines |
|-------------------------------------|---|
| Link Remediation Name | Enter a name for link remediation. |
| Link Remediation Description | Enter a description for the link remediation. |
| Remediation Type | <p>Choose one of the following:</p> <ul style="list-style-type: none"> • Automatic: When selected, you should enter values for the Interval and Retry Count. • Manual: When selected, Retry Count and Interval fields are not editable. |
| Retry Count | Enter the number of attempts that clients can try to remediate from the link. |

| Field Name | Usage Guidelines |
|-----------------------|---|
| Interval (in seconds) | Enter the time interval in seconds that clients can try to remediate from the link after previous attempts. |
| URL | Enter a valid URL that leads to a remediation page or resource. |

Related Topics

[Add a Link Remediation](#), on page 778

Application Remediation

The following table describes the fields in the **Application Remediation** window. The navigation path is **Policy > Policy Elements > Results > Posture > Remediation Actions > Application Remediation**.

Table 158: Application Remediation

| Field Name | Usage Guidelines |
|-----------------------|---|
| Name | Enter a name for the application remediation. |
| Description | Enter the description for the application remediation. |
| Operating System | Select the Windows OS or MAC OSX to which the application remediation condition should be applied. |
| Compliance Module | Support for OESIS version 4.x or later. |
| Remediation Type | Choose one of the following: <ul style="list-style-type: none"> • Automatic: Enter values for the Interval and Retry Count. The ISE server identifies non-compliant clients and selects a remediation notification method and automatically updates the latest patch on the client. • Manual: (Interval and Retry Count fields are disabled) Non-compliant clients should manually download and apply the latest patches. |
| Interval (in seconds) | (Available only when you select the Automatic remediation type) Enter the time interval in seconds after which a scheduled patch update on the client is performed. Valid range is 0 to 9999. |
| Retry Count | (Available only when you select the Automatic remediation type) Enter the number of times that a client can attempt to update critical patches. Valid range is 0 to 99. |

| Field Name | Usage Guidelines |
|---------------------------|--|
| Vendor Name | <p>Choose a vendor name from the drop-down list. The application name (for example, Internet Explorer), version, vendor (for example, Microsoft Corporation), running processes, and category (for example, anti-phishing) are displayed in the Products for Selected Vendor table.</p> <p>Note Supported versions of Cisco ISE and AnyConnect:</p> <ul style="list-style-type: none"> • Cisco ISE version 2.2 and later • AnyConnect version 4.4 and later |
| Remediation Option | <p>Select any one of the following options:</p> <ul style="list-style-type: none"> • Uninstall: Uninstalls an application. For example, you observe that there are many endpoints that are running a malicious application in the Context Directory page. You can create a requirement that uninstalls the malicious application. • Kill Process: Kills the required running patch management process. For example, you observe that there are many endpoints that are running a malicious process in the Context Directory page. You can create a requirement that kills these malicious processes that are running. <p>Click the Products for Selected Vendor drop-down arrow, to view the list of products that the vendor you have specified in the Patch Management Vendor Name supports. For example, if you have selected Vendor A, that has two products, namely Product 1 and Product 2. Product 1 may support the Enable remediation option, whereas Product 2 might not. Or, if Product 1 does not support the Enable and Install missing patches remediation options, then Product 1 is disabled (grayed out). The Products for Selected Vendor table changes according to the selected remediation option.</p> |

Antimalware Remediation

The following table describes the fields in the **AV Remediation** window. The navigation path is **Policy > Policy Elements > Results > Posture > Remediation Actions > AV Remediation**.

Table 159: Antivirus Remediation

| Field Name | Usage Guidelines |
|--------------------------|--|
| Name | Enter a name for the antimalware remediation. |
| Description | Enter a description for the antimalware remediation. |
| Operating System | Choose one of the following: <ul style="list-style-type: none"> • Windows • Macintosh: when selected Remediation Type, Interval, and Retry Count fields are not editable |
| Compliance Module | OESIS version 4 supports compliance module 4.x and AnyConnect 4.3 and higher. |
| Remediation Type | Choose one of the following: <ul style="list-style-type: none"> • Automatic: When selected, you should enter values for the Interval and Retry Count. • Manual: When selected, Retry Count and Interval fields are not editable. |
| Interval (in seconds) | Enter the time interval in seconds that clients can try to remediate after previous attempts. |
| Retry Count | Enter the number of attempts that clients can try to update an antimalware definition. |
| Anti-Malware Vendor Name | Choose the required antimalware vendor. |

Related Topics

[Create Posture Requirement in Clientless Mode](#), on page 791

Antivirus Remediation

The following table describes the fields in the **Anti-Virus Remediation** window. The navigation path is **Policy > Policy Elements > Results > Posture > Remediation Actions > Anti-Virus Remediation**.

Table 160: Anti-Virus Remediation

| Field Name | Usage Guidelines |
|-------------|--|
| Name | Enter a name for the antivirus remediation. |
| Description | Enter a description for the antivirus remediation. |

| Field Name | Usage Guidelines |
|-----------------------|--|
| Remediation Type | Choose one of the following: <ul style="list-style-type: none"> • Automatic: When selected, you should enter values for the Interval and Retry Count. • Manual: When selected, Retry Count and Interval fields are not editable. |
| Interval (in seconds) | Enter the time interval in seconds that clients can try to remediate after previous attempts. |
| Retry Count | Enter the number of attempts that clients can try to update an antivirus definition. |
| Operating System | Choose one of the following: <ul style="list-style-type: none"> • Windows • Macintosh: When selected Remediation Type, Interval, and Retry Count fields are not editable |
| AV Vendor Name | Choose the antivirus vendor. |

Related Topics

[Add an Antivirus Remediation](#), on page 778

[Create Posture Requirement in Clientless Mode](#), on page 791

Antispyware Remediation

The following table describes the fields in the **Antispyware Remediation** page. The navigation path is **Policy > Policy Elements > Results > Posture > Remediation Actions > Antispyware Remediation**.

Table 161: Antispyware Remediation

| Field Name | Usage Guidelines |
|-----------------------|--|
| Name | Enter a name for the antispyware remediation. |
| Description | Enter a description for the antispyware remediation. |
| Remediation Type | Choose one of the following: <ul style="list-style-type: none"> • Automatic: When selected, you should enter values for the Interval and Retry Count. • Manual: When selected, Retry Count and Interval fields are not editable. |
| Interval (in seconds) | Enter the time interval in seconds that clients can try to remediate after previous attempts. |

| Field Name | Usage Guidelines |
|------------------|---|
| Retry Count | Enter the number of attempts that clients can try to update an antispysware definition. |
| Operating System | Choose one of the following: <ul style="list-style-type: none"> • Windows • Macintosh: When selected, Remediation Type, Interval, and Retry Count fields are not editable |
| AS Vendor Name | Choose the antispysware vendor. |

Related Topics

[Add an Antispysware Remediation](#), on page 779

[Create Posture Requirement in Clientless Mode](#), on page 791

Launch Program Remediation

The following table describes the fields in the **Launch Program Remediation** window. The navigation path is **Policy > Policy Elements > Results > Posture > Remediation Actions > Launch Program Remediation**.

Table 162: Launch Program Remediation

| Field Name | Usage Guidelines |
|-----------------------|---|
| Name | Enter a name for the launch program remediation. |
| Description | Enter a description for the launch program remediation that you want to create. |
| Remediation Type | Choose one of the following: <ul style="list-style-type: none"> • Automatic: When selected, you should enter the Retry Count and Interval options. • Manual: When selected, Interval and Retry Count fields are not editable. |
| Interval (in seconds) | Enter the time interval in seconds that clients can try to remediate after previous attempts. |
| Retry Count | Enter the number of attempts that clients can try to launch required programs. |

| Field Name | Usage Guidelines |
|----------------------------------|---|
| Program Installation Path | <p>From the drop-down list, choose the path where the remediation program has to be installed.</p> <ul style="list-style-type: none"> • ABSOLUTE_PATH: Remediation program is installed in the fully qualified path of the file. For example, C:\<directory>\ • SYSTEM_32: Remediation program is installed in the C:\WINDOWS\system32 directory • SYSTEM_DRIVE: Remediation program is installed in the C:\ drive • SYSTEM_PROGRAMS: Remediation program is installed in the C:\Program Files • SYSTEM_ROOT: Remediation program is installed in the root path of Windows system |
| Program Executable | Enter the name of the remediation program executable, or an installation file. |
| Program Parameters | Enter required parameters for the remediation programs. |
| Existing Programs | <p>Existing Programs table displays the installation paths, name of the remediation programs, and parameters if any.</p> <ul style="list-style-type: none"> • Click Add to add remediation programs to the Existing Programs list. • Click the delete icon to remove the remediation programs from the list. |

Related Topics

[Add a Launch Program Remediation](#), on page 779

[Troubleshoot Launch Program Remediation](#), on page 780

[Create Posture Requirement in Clientless Mode](#), on page 791

Windows Update Remediation

The following table describes the fields in the **Windows Update Remediation** windows. The navigation path is **Policy > Policy Elements > Results > Posture > Remediation Actions > Windows Update Remediation**.

Table 163: Windows Update Remediation

| Field Name | Usage Guidelines |
|-------------|--|
| Name | Enter a name for the Windows update remediation. |

| Field Name | Usage Guidelines |
|--|---|
| Description | Enter a description for the Windows update remediation. |
| Remediation Type | Choose one of the following: <ul style="list-style-type: none"> • Automatic: When selected, you should enter the Retry Count and Interval options. • Manual: When selected, Interval and Retry Count fields are not editable. |
| Interval (in seconds) | Enter the time interval in seconds that clients can try to remediate after previous attempts. |
| Retry Count | Enter the number of attempts that Windows clients can try for Windows updates. |
| Windows Update Setting | Choose from the following: <ul style="list-style-type: none"> • Do not change setting: The Windows Automatic Updates client configuration does not change during or after Windows update remediation. • Notify to download and install: Windows only notifies clients, but does not automatically download, or install them. • Automatically download and notify to install: Windows downloads updates for clients, and notifies clients to install Windows updates. • Automatically download and install: Windows automatically downloads, and installs Windows updates. This is the highly recommended setting for Windows clients. |
| Override User's Windows Update setting with administrator's | Check this check box to enforce the administrator-specified setting for Windows Automatic Updates on all the clients during, and after Windows update remediation.

If unchecked, the setting enforces the following: <ul style="list-style-type: none"> • The administrator-specified setting only when Automatic Updates are disabled on Windows clients. • The Windows clients-specified setting only when Windows Automatic Updates are enabled on the client. |

Related Topics

[Add a Windows Update Remediation](#), on page 780

[Create Posture Requirement in Clientless Mode](#), on page 791

Windows Server Update Services Remediation

The following table describes the fields in the **Windows Update Remediation** window. The navigation path is **Policy > Policy Elements > Results > Posture > Remediation Actions > Windows Server Update Services Remediation**.

Table 164: WSUS Remediation

| Field Name | Usage Guidelines |
|---------------------------------------|---|
| Name | Enter a name for the WSUS remediation. |
| Description | Enter a description for the WSUS remediation. |
| Remediation Type | Choose from the following: <ul style="list-style-type: none"> • Automatic: The agent automatically updates Windows clients with the latest WSUS updates. • Manual: If selected, the Interval and Retry Count fields are not editable. The user manually updates the Windows client with the latest WSUS updates from a Microsoft-managed WSUS server, or from the locally administered WSUS server. |
| Interval (in seconds) | Enter the interval in seconds (the default interval is 0) to delay WSUS updates before the client and web agents attempt to retry after the previous attempt. |
| Retry Count | Enter the number of attempts that the client and web agents retry to update Windows clients with WSUS updates. |
| Validate Windows Updates using | Choose from the following: <ul style="list-style-type: none"> • Cisco Rules: If you choose this option, you can select custom or preconfigured rules as conditions in the posture requirement • Severity Level: If you choose this option, you can select custom or preconfigured rules as conditions in the posture requirement, but they are not used. The pr_WSUSRule can be used as a placeholder condition (a dummy condition) in the posture requirement that specifies a WSUS remediation. |

| Field Name | Usage Guidelines |
|--|--|
| Windows Updates Severity Level | <p>Choose the severity level:</p> <ul style="list-style-type: none"> • Critical: Installs only critical Windows updates • Express: Installs important and critical Windows updates • Medium: Installs all critical, important, and moderate Windows updates • All: Installs all critical, important, moderate, and low Windows updates <p>Note When you associate a WSUS remediation action to a posture requirement to validate Windows updates by using the severity level option, you must choose the pr_WSUSRule (a dummy compound condition) compound condition in the posture requirement. When the posture requirement fails, the agent enforces the remediation action (Windows updates) based on the severity level that you define in the WSUS remediation.</p> |
| Update to latest OS Service Pack | <p>Check this check box to allow WSUS remediation install the latest service pack available for the client's operating system automatically.</p> <p>Note The operating system service packs are updated automatically irrespective of the Medium and All severity level options selected in WSUS remediation.</p> |
| Windows Updates Installation Source | <p>Specifies the source from where you install WSUS updates on Windows clients:</p> <ul style="list-style-type: none"> • Microsoft server: Microsoft-managed WSUS server • Managed server: Locally administered WSUS server |

| Field Name | Usage Guidelines |
|--|---|
| Installation Wizard Interface Setting | <p>Allows you to display the installation wizard on the client during WSUS updates:</p> <ul style="list-style-type: none"> • Show UI: Displays the Windows Update Installation Wizard progress on Windows clients. Users must have Administrator privileges on clients to view the installation wizard during WSUS updates. • No UI: Hides the Windows Update Installation Wizard progress on Windows clients. <p>Note You must select the No UI option, if you want to allow users without Administrator privileges to use WSUS remediation to install Windows updates.</p> |

Related Topics

[Add a Windows Server Update Services Remediation](#), on page 780

[Create Posture Requirement in Clientless Mode](#), on page 791

Patch Management Remediation

The following table describes the fields in the **Patch Management Remediation** window. The navigation path is **Policy > Policy Elements > Results > Posture > Remediation Actions > Patch Management Remediation**.

Table 165: Patch Management Remediation

| Field Name | Usage Guidelines |
|-------------------------|--|
| Name | Enter a name for the patch management remediation. |
| Description | Enter a description for the patch management remediation. |
| Remediation Type | <p>Choose one of the following:</p> <ul style="list-style-type: none"> • Automatic: Enter values for the Interval and Retry Count. The ISE server identifies non-compliant clients and selects a remediation notification method and automatically updates the latest patch on the client. • Manual: (Interval and Retry Count fields are disabled) Non-compliant clients should download and apply the latest patches manually. |

| Field Name | Usage Guidelines |
|-------------------------------------|--|
| Interval (in seconds) | (Available only when you select the Automatic remediation type) Enter the time interval in seconds after which a scheduled patch update on the client is performed. |
| Retry Count | (Available only when you select the Automatic remediation type) Enter the number of times that a client can attempt to update critical patches. |
| Operating System | Windows OS is the only OS that is supported. |
| Patch Management Vendor Name | <p>Choose a vendor name from the drop-down list. The patch management remediation products of a vendor along with their product's support for the version, enable remediation, update remediation, and show UI remediation is displayed in the Products for Selected Vendor table.</p> <p>Note Supported versions of Cisco ISE and AnyConnect:</p> <ul style="list-style-type: none"> • Cisco ISE version 1.4 and later • AnyConnect version 4.1 and later |
| Remediation Option | <p>Select any one of the following options:</p> <ul style="list-style-type: none"> • Enable: Enables the patch management software, in case it is disabled on the endpoint. • Install Missing Patches: Updates the patch on the endpoint. • Activate Patch Management Software GUI: Displays the patch management software user interface. Follow the instructions on this page to change the software settings or initiate software updates. <p>Click the Products for Selected Vendor drop-down arrow, to view the list of products that the vendor you have specified in the Patch Management Vendor Name supports. For example, if you have selected Vendor A, that has two products, namely Product 1 and Product 2. Product 1 may support the Enable remediation option, whereas Product 2 might not. Or, if Product 1 does not support the Enable and Install missing patches remediation options, then Product 1 is disabled (grayed out). The Products for Selected Vendor table changes according to the selected remediation option.</p> |

Related Topics

[Add a Patch Management Remediation](#), on page 778

[Create Posture Requirement in Clientless Mode](#), on page 791

USB Mass Storage Check Workflow

You can use the USB_Check condition (Cisco predefined) in a posture policy to check if a USB mass storage device is connected to an endpoint . The USB mass storage check and remediation flow is described below.

The AnyConnect agent:

- Checks for a USB connection.
- Detects a USB plug-in and applies the USB_Block remediation (Cisco predefined). The AnyConnect agent reports a remediation failure to Cisco ISE and initiates a CoA. The USB mass storage remediation is always active and is not limited to the time of access or Periodic reassessment (PRA).
- Stops running the USB detection, when the user disconnects from the network interface.
- Runs the posture flow again, when the endpoint reconnects. However, if the endpoint is in the posture lease period, the AnyConnect agent does not run the USB check again.



Note AnyConnect performs the USB check and remediation sequentially. Consequently, there may be a delay in handling USB dynamic change while performing PRA. When the USB check is configured, it is recommended to minimize the PRA grace time (**Work Centers > Posture > Settings > Reassessment Configurations**) for the other checks.



Note You cannot create a compound condition for USB check.

Related Topics

[USB Condition Settings](#), on page 1115

[Simple Posture Conditions](#), on page 551

USB Mass Storage Remediation

The following table describes the fields in the **USB Mass Storage Remediation** window. The navigation path is **Work Centers > Posture > Policy Elements > Remediations > USB**. You can also view the option in the **Policy > Policy Elements > Results > Posture > Remediation Actions > USB Remediation** window.

Table 166: USB Remediation Settings

| Field Name | Usage Guideline |
|-------------|--|
| Name | Enter the name for the USB remediation. |
| Description | Enter a description for the USB remediation. |

| Field Name | Usage Guideline |
|--------------------------|--|
| Compliance Module | A display-only field for ISE posture compliance module support for version 4.x (and later). |
| Operating System | A display-only field to indicate support for Windows OS. |
| Remediation Type | A display-only field to indicate that the remediation is automatic. |
| Interval | Enter the time interval in seconds after which a scheduled USB mass storage device check on the client is performed. |
| Retry Count | Enter the time interval in seconds after which a USB mass storage device reassessment on the client is performed. |

Related Topics

[Simple Posture Conditions](#), on page 551

Client Posture Requirements

To create a posture requirement:

1. Choose **Policy > Policy Elements > Results > Posture > Requirements**.
2. From the **Edit** drop-down list at the end of any requirement row, choose **Insert New Requirement**.
3. Enter the required details and click **Done**.

The following table describes the fields in the **Client Posture Requirements** window.

Table 167: Posture Requirement

Related Topics

[Configure Acceptable Use Policies for Posture Assessment](#), on page 767

[Create Client Posture Requirements](#), on page 782



CHAPTER 33

Operations User Interface Reference

- [RADIUS Live Logs, on page 1149](#)
- [RADIUS Live Sessions, on page 1152](#)
- [TACACS Live Logs, on page 1155](#)
- [Diagnostic Tools, on page 1157](#)

RADIUS Live Logs

The following table describes the fields in the Live logs window that displays the recent RADIUS authentications. The navigation path for this page is: **Operations > RADIUS > Live Logs**. Note that you can view the RADIUS live logs only in the Primary PAN.

Table 168: RADIUS Live Logs

| Field Name | Description |
|---------------|---|
| Time | Shows the time at which the log was received by the monitoring and troubleshooting collection agent. This column is required and cannot be deselected. |
| Status | Shows if the authentication succeeded or failed. This column is mandatory and cannot be deselected. Green is used to represent passed authentications. Red is used to represent failed authentications. |

| Field Name | Description |
|-------------------------------|---|
| Details | <p>Clicking the icon under the Details column opens the Authentication Detail Report in a new browser window. This report offers information about authentication and related attributes, and authentication flow. In the Authentication Details box, Response Time is the total time it takes Cisco ISE to process the authentication flow. For example, if authentication consists of three roundtrip messages that took 300 ms for the initial message, 150 ms for the next message, and 100 ms for the last, Response Time is $300 + 150 + 100 = 550$ ms.</p> <p>Note You cannot view the details for endpoints that are active for more than 48 hours. You will see a window with the following message when you click the Details icon for endpoints that are active for more than 48 hours: No Data available for this record. Either the data is purged or authentication for this session record happened a week ago. Or if this is an 'PassiveID' or 'PassiveID Visibility' session, it will not have authentication details on ISE but only the session.</p> |
| Repeat Count | Shows the number of time the authentication requests were repeated in the last 24 hours, without any change in the context of identity, network devices, and authorization. |
| Identity | Shows the logged in username that is associated with the authentication. |
| Endpoint ID | Shows the unique identifier for an endpoint, usually a MAC or IP address. |
| Endpoint Profile | Shows the type of endpoint that is profiled, for example, profiled to be an iPhone, Android, MacBook, Xbox, and so on. |
| Authentication Policy | Shows the name of the policy selected for specific authentication. |
| Authorization Policy | Shows the name of the policy selected for specific authorization. |
| Authorization Profiles | Shows the authorization profile that was used for authentication. |
| IP Address | Shows the IP address of the endpoint device. |

| Field Name | Description |
|--------------------------------|---|
| Network Device | Shows the IP address of the Network Access Device. |
| Device Port | Shows the port number at which the endpoint is connected. |
| Identity Group | Shows the identity group that is assigned to the user or endpoint, for which the log was generated. |
| Posture Status | Shows the status of posture validation and details on the authentication. |
| Server | Indicates the policy service from which the log was generated. |
| MDM Server Name | Shows the name of the MDM server. |
| Event | Shows the event status. |
| Failure Reason | Shows the detailed reason for failure, if the authentication failed. |
| Auth Method | Shows the authentication method that is used by the RADIUS protocol, such as Microsoft Challenge Handshake Authentication Protocol Version 2 (MS-CHAPv2), IEE 802.1x or dot1x, and so on. |
| Authentication Protocol | Shows the authentication protocol used, such as Protected Extensible Authentication Protocol (PEAP), Extensible Authentication Protocol (EAP), and so on. |
| Security Group | Shows the group that is identified by the authentication log. |
| Session ID | Shows the session ID. |



Note In the **RADIUS Live Logs** and **TACACS+ Live Logs** window, a Queried PIP entry appears for the first attribute of each policy authorization rule. If all the attributes within the authorization rule are related to a dictionary that was already queried for previous rules, no additional Queried PIP entry appears.

You can do the following in the **RADIUS Live Logs** window:

- Export the data in CSV or PDF format.
- Show or hide the columns based on your requirements.
- Filter the data using the quick or custom filter. You can also save your filters for later use.
- Rearrange the columns and adjust the width of the columns.
- Sort the column values.



Note All the user customizations are stored as user preferences.

RADIUS Live Sessions

The following table describes the fields in the RADIUS **Live Sessions** window, which displays live authentications. The navigation path for this page is: **Operations > RADIUS > Live Sessions**. You can view the RADIUS live sessions only in the Primary PAN.

Table 169: RADIUS Live Sessions

| Field Name | Description |
|-----------------------------|--|
| Initiated | Shows the timestamp when the session was initiated. |
| Updated | Shows the timestamp when the session was last updated because of a change. |
| Account Session Time | Shows the time span (in seconds) of a user's session. |
| Session Status | Shows the current status of an endpoint device. |
| Action | Click the Actions icon to reauthenticate an active RADIUS session or disconnect an active RADIUS session. |
| Repeat Count | Shows the number of times a user or endpoint is reauthenticated. |
| Endpoint ID | Shows the unique identifier for an endpoint, usually a MAC or IP address. |
| Identity | Shows the username of an endpoint device. |
| IP Address | Shows the IP address of an endpoint device. |
| Audit Session ID | Shows a unique session identifier. |
| Account Session ID | Shows a unique ID provided by a network device. |
| Endpoint Profile | Shows the endpoint profile for a device. |
| Posture Status | Shows the status of posture validation and details of the authentication. |
| Security Group | Shows the group that is identified by the authentication log. |
| Server | Indicates the Policy Service node from which the log was generated. |

| Field Name | Description |
|--------------------------------|---|
| Auth Method | Shows the authentication method that is used by the RADIUS protocol, such as Password Authentication Protocol (PAP), Challenge Handshake Authentication Protocol (CHAP), IEE 802.1x or dot1x, and so on. |
| Authentication Protocol | Shows the authentication protocol used, such as Protected Extensible Authentication Protocol (PEAP), Extensible Authentication Protocol (EAP), and so on. |
| Authentication Policy | Shows the name of the policy selected for specific authentication. |
| Authorization Policy | Shows the name of the policy selected for specific authorization. |
| Authorization Profiles | Shows an authorization profile that was used for authentication. |
| NAS IP Address | Shows the IP address of a network device. |
| Device Port | Shows the connected port to a network device. |
| PRA Action | Shows the periodic reassessment action taken on a client after it is successfully postured for compliance on your network. |
| ANC Status | Adaptive Network Control status of a device as Quarantine , Unquarantine , or Shutdown . |
| WLC Roam | Shows the boolean (Y/N) used to track if an endpoint has been handed off during roaming, from one Wireless Lan Controller (WLC) to another. It has the value of <code>cisco-av-pair=nas-update=Y</code> or <code>N</code> .

Note Cisco ISE relies on the <code>nas-update=true</code> attribute from WLC to identify whether the session is in roaming state. When the original WLC sends an accounting stop attribute with <code>nas-update=true</code> , the session is not deleted in ISE to avoid reauthentication. If roaming fails, ISE clears the session after five days of inactivity. |
| Packets In | Shows the number of packets received. |
| Packets Out | Shows the number of packets sent. |
| Bytes In | Shows the number of bytes received. |
| Bytes Out | Shows the number of bytes sent. |

| Field Name | Description |
|-------------------|--|
| Session Source | Indicates whether it is a RADIUS session or a Passive ID session. |
| User Domain Name | Shows the registered DNS name of a user. |
| Host Domain Name | Shows the registered DNS name of a host. |
| User NetBIOS Name | Shows the NetBIOS name of a user. |
| Host NetBIOS Name | Shows the NetBIOS name of a host. |
| License Type | Shows the type of license used, Base, Plus, Apex, or Plus and Apex. |
| License Details | Shows the license details. |
| Provider | <p>Endpoint events are learned from different syslog sources. These syslog sources are referred to as providers.</p> <ul style="list-style-type: none"> • Windows Management Instrumentation (WMI): WMI is a Windows service that provides a common interface and object model to access management information about operating system, devices, applications, and services. • Agent: A program that runs on a client on behalf of the client or another program. • Syslog: A logging server to which a client sends event messages. • REST: A client is authenticated through a terminal server. The TS Agent ID, Source Port Start, Source Port End, and Source First Port values are displayed for this syslog source. • Span: Network information is discovered using span probes. • DHCP: DHCP event. • Endpoint <p>Note When two events from different providers are learned or obtained from an endpoint session, the providers are displayed as comma-separated values in the Live Sessions window.</p> |
| MAC Address | Shows the MAC address of a client. |

| Field Name | Description |
|------------------------------------|---|
| Endpoint Check Time | Shows the time at which an endpoint was last checked by the endpoint probe. |
| Endpoint Check Result | Shows the result of an endpoint probe. The possible values are: <ul style="list-style-type: none"> • Unreachable • User Logout • Active User |
| Source Port Start | (Values are displayed only for the REST provider)
Shows the first port number in a port range. |
| Source Port End | (Values are displayed only for the REST provider)
Shows the last port number in a port range. |
| Source First Port | (Values are displayed only for the REST provider)
Shows the first port allocated by the Terminal Server Agent.

A Terminal Server refers to a server or network device that allows multiple endpoints to connect to it without a modem or network interface and facilitates the connection of the multiple endpoints to a LAN network. The multiple endpoints appear to have the same IP address, and therefore, it is difficult to identify the IP address of a specific user. Consequently, to identify a specific user, a Terminal Server Agent is installed in the server, which allocates a port range to each user. This helps create an IP address-port user mapping. |
| TS Agent ID | (Values are displayed only for the REST provider)
Shows the unique identity of the Terminal Server Agent that is installed on an endpoint. |
| AD User Resolved Identities | (Values are displayed only for AD user) Shows the potential accounts that matched. |
| AD User Resolved DNs | (Values are displayed only for AD user) Shows the Distinguished Name of AD user, for example, CN=chris,CN=Users,DC=R1,DC=com |

TACACS Live Logs

The following table describes the fields in the TACACS Live Logs window that displays the TACACS+ AAA details. The navigation path for this page is: **Operations > TACACS > Live Logs**. You can view the TACACS live logs only in the Primary PAN.

Table 170: TACACS Live Logs

| Field Name | Usage Guidelines |
|------------------------------|--|
| Generated Time | Shows the syslog generation time based on when a particular event was triggered. |
| Logged Time | Shows the time when the syslog was processed and stored by the Monitoring node. This column is mandatory and cannot be deselected. |
| Status | Shows if the authentication succeeded or failed. This column is required and cannot be deselected. Green is used to represent passed authentications. Red is used to represent failed authentications. |
| Details | Brings up a report when you click the magnifying glass icon, allowing you to drill down and view more detailed information about the selected authentication scenario. This column is required and cannot be deselected. |
| Session Key | Shows the session keys (found in the EAP success or EAP failure messages) returned by ISE to the network device. |
| Username | Shows the user name of the device administrator. This column is required and cannot be deselected. |
| Type | Consists of two Types—Authentication and Authorization. Shows names of users who have passed or failed authentication, authorization, or both. This column is mandatory and cannot be deselected. |
| Authentication Policy | Shows the name of the policy selected for specific authentication. |
| Authorization Policy | Shows the name of the policy selected for specific authorization. |
| ISE Node | Shows the name of the ISE node through which the access request is processed. |
| Network Device Name | Shows the names of network devices. |
| Network Device IP | Shows the IP addresses of network devices whose access requests are processed. |
| Network Device Groups | Shows the name of corresponding network device groups to which a network device belongs. |
| Device Type | Shows the device type policy used to process access requests from different network devices. |

| Field Name | Usage Guidelines |
|----------------------------|---|
| Location | Shows the location-based policy used to process access requests from network devices. |
| Device Port | Shows the device port number through which the access request is made. |
| Failure Reason | Shows the reason for rejecting an access request made by a network device. |
| Remote Address | Shows the IP address, MAC address, or any other string that uniquely identifies the end station. |
| Matched Command Set | Shows the MatchedCommandSet attribute value if it is present, or an empty value if the MatchedCommandSet attribute value is empty or the attribute itself does not exist in the syslog. |
| Shell Profile | Shows the privileges that were granted to a device administrator for executing commands on the network device. |

You can do the following in the **TACACS Live Logs** window:

- Export the data in CSV or PDF format.
- Show or hide the columns based on your requirements.
- Filter the data using quick or custom filter. You can also save your filters for later use.
- Rearrange the columns and adjust the width of the columns.
- Sort the column values.



Note All the user customizations are stored as user preferences.

Diagnostic Tools

RADIUS Authentication Troubleshooting Settings

The following table describes the fields on the RADIUS authentication troubleshooting page which allow you to identify and resolve RADIUS authentication problems. The navigation path for this page is: **Operations > Troubleshoot > Diagnostic Tools > General Tools > RADIUS Authentication Troubleshooting**.

Table 171: RADIUS Authentication Troubleshooting Settings

| Option | Usage Guidelines |
|-------------------------|---|
| Username | Enter the username of the user whose authentication you want to troubleshoot. |
| MAC Address | Enter the MAC address of the device that you want to troubleshoot. |
| Audit Session ID | Enter the audit session ID that you want to troubleshoot. |
| NAS IP | Enter the NAS IP address. |
| NAS Port | Enter the NAS port number. |
| Authentication Status | Choose the status of your RADIUS authentication. |
| Failure Reason | Enter the failure reason or click Select to choose a failure reason from a list. Click Clear to clear the failure reason. |
| Time Range | Select a time range. The RADIUS authentication records that are created during this time range are used. |
| Start Date-Time | If you choose Custom Time Range, enter the start date and time, or click the calendar icon to select the start date and time. The date should be in the <i>mm/dd/yyyy</i> format and time in the <i>hh:mm</i> format. |
| End Date-Time | If you choose Custom Time Range, enter the end date and time, or click the calendar icon to select the end date and time. The date should be in the <i>mm/dd/yyyy</i> format and time in the <i>hh:mm</i> format. |
| Fetch Number of Records | Choose the number of records that you want to fetch from the drop-down list: 10, 20, 50, 100, 200, or 500. |

Related Topics

[Troubleshoot Unexpected RADIUS Authentication Results](#), on page 878

[The RADIUS Authentication Troubleshooting Tool](#), on page 878

Execute Network Device Command Settings

The following table describes the fields on the Execute Network Device Command page, which you use to execute the **show** command on a network device. The navigation path for this page is: **Operations > Troubleshoot > Diagnostic Tools > General Tools > Execute Network Device**.

Table 172: Execute Network Device Command Settings

| Option | Usage Guidelines |
|-------------------|--|
| Enter Information | |
| Network Device IP | Enter the IP address of the network device on which you want to run the command. |
| Command | Enter the show command. |

Related Topics

[Execute Cisco IOS show Commands to Check Configuration](#), on page 879

[The Execute Network Device Command Diagnostic Tool](#), on page 879

Evaluate Configuration Validator Settings

The following table describes the fields on the Evaluate Configuration Validator page, which you use to evaluate the configuration of a network device and identify any configuration problems. The navigation path for this page is: **Operations > Troubleshoot > Diagnostic Tools > General Tools > Evaluate Configuration Validator**.

Table 173: Evaluate Configuration Validator Settings

| Option | Usage Guidelines |
|---|--|
| Enter Information | |
| Network Device IP | Enter the IP address of the network device whose configuration you want to evaluate. |
| Select the configuration items below that you want to compare against the recommended template. | |
| AAA | This option is selected by default. |
| RADIUS | This option is selected by default. |
| Device Discovery | This option is selected by default. |
| Logging | This option is selected by default. |
| Web Authentication | Check this check box to compare the web authentication configuration. |
| Profiler Configuration | Check this check box to compare the Profiler configuration. |
| Trustsec | Check this check box if you want to compare Trustsec configuration. |
| 802.1X | Check this check box if you want to compare the 802.1X configuration, and choose one of the available options. |

Related Topics

[Troubleshoot Network Device Configuration Issues](#), on page 880

[The Evaluate Configuration Validator Tool](#), on page 880

Posture Troubleshooting Settings

The following table describes the fields on the Posture troubleshooting window, which you use to find and resolve posture problems on the network. The navigation path for this window is: **Operations > Troubleshoot > Diagnostic Tools > General Tools > Posture Troubleshooting**.

Table 174: Posture Troubleshooting Settings

| Field Name | Usage Guidelines |
|--|---|
| Search and Select a Posture event for troubleshooting | |
| Username | Enter the username to filter on. |
| MAC Address | Enter the MAC address to filter on, using format: xx-xx-xx-xx-xx-xx |
| Posture Status | Select the authentication status to filter on: |
| Failure Reason | Enter the failure reason or click Select to choose a failure reason from a list. Click Clear to clear the failure reason. |
| Time Range | Select a time range. The RADIUS authentication records that are created during this time range are used. |
| Start Date-Time: | (Available only when you choose Custom Time Range) Enter the start date and time, or click the calendar icon to select the start date and time. The date should be in the <i>mm/dd/yyyy</i> format and time in the <i>hh:mm</i> format. |
| End Date-Time: | (Available only when you choose Custom Time Range) Enter the end date and time, or click the calendar icon to select the start date and time. The date should be in the <i>mm/dd/yyyy</i> format and time in the <i>hh:mm</i> format. |
| Fetch Number of Records | Select the number of records to display: 10, 20, 50, 100, 200, 500 |
| Search Result | |
| Time | Time of the event |
| Status | Posture status |
| Username | User name associated with the event |

| Field Name | Usage Guidelines |
|----------------|------------------------------|
| MAC Address | MAC address of the system |
| Failure Reason | Failure reason for the event |

Related Topics

[Posture Troubleshooting Tool](#), on page 880

TCP Dump Settings

The following table describes the fields on the **tcpdump** utility page, which you use to monitor the contents of packets on a network interface and troubleshoot problems on the network as they appear. The navigation path for this page is: **Operations > Troubleshoot > Diagnostic Tools > General Tools > TCP Dump**.

Table 175: TCP Dump Settings

| Option | Usage Guidelines |
|-------------------|---|
| Status | <ul style="list-style-type: none"> • Stopped—the tcpdump utility is not running • Start—Click to start the tcpdump utility monitoring the network. • Stop—Click to stop the tcpdump utility |
| Host Name | Choose the name of the host to monitor from the drop-down list. |
| Network Interface | <p>Choose the network interface to monitor from the drop-down list.</p> <p>Note You must configure all network interface cards (NICs) with an IPv4 or IPv6 address so that they are displayed in the Cisco ISE Admin portal.</p> |
| Promiscuous Mode | <ul style="list-style-type: none"> • On—Click to turn on promiscuous mode (default). • Off—Click to turn off promiscuous mode. <p>Promiscuous mode is the default packet sniffing mode. It is recommended that you leave it set to On. In this mode the network interface is passing all traffic to the system's CPU.</p> |

| Option | Usage Guidelines |
|-----------|--|
| Filter | Enter a boolean expression on which to filter.
Supported standard tcpdump filter expressions:

ip host 10.77.122.123

ip host 10.77.122.123 and not 10.177.122.119

ip host ISE123 |
| Format | Select a format for the tcpdump file. |
| Dump File | Displays data on the last dump file, such as the following:

Last created on Wed Apr 27 20:42:38 UTC 2011 by admin

File size: 3,744 bytes
Format: Raw Packet Data
Host Name: Positron
Network Interface: GigabitEthernet 0
Promiscuous Mode: On

<ul style="list-style-type: none"> • Download—Click to download the most recent dump file. • Delete—Click to delete the most recent dump file. |

Related Topics

[Use TCP Dump to Monitor Network Traffic](#), on page 883

[Save a TCP Dump File](#), on page 884

[TCP Dump Utility to Validate Incoming Traffic](#), on page 883

SXP-IP Mappings

The following table describes the fields on the SXP-IP mappings page, which you use to compare mappings between a device and its peers. The navigation path for this page is: **Operations > Troubleshoot > Diagnostic Tools > Trustsec Tools > SXP-IP Mappings**.

Peer SXP Devices

Table 176: Peer SXP Devices for SXP-IP Mappings

| Option | Usage Guidelines |
|------------------|--------------------------------------|
| Peer SXP Devices | |
| Peer IP Address | IP address of the peer SXP device. |
| VRF | The VRF instance of the peer device. |

| Option | Usage Guidelines |
|-----------------------------------|--|
| Peer SXP Mode | The SXP mode of the peer device; for example, whether it is a speaker or a listener. |
| Self SXP Mode | The SXP mode of the network device; for example, whether it is a speaker or a listener. |
| Connection State | The status of the connection. |
| Common Connection Parameters | |
| User Common Connection Parameters | <p>Check this check box to enable common connection parameters for all the peer SXP devices.</p> <p>Note If the common connection parameters are not specified or if they do not work for some reason, the Expert Troubleshooter again prompts you for connection parameters for that particular peer device.</p> |
| Username | Enter the username of the peer SXP device. |
| Password | Enter the password to gain access to the peer device. |
| Protocol | <ul style="list-style-type: none"> Choose the protocol. <p>Note Telnet is the default option. If you choose SSHv2, you must ensure that SSH connections are enabled on the network device.</p> |
| Port | <ul style="list-style-type: none"> Enter the port number. The default port number for Telnet is 23 and SSH is 22. |
| Enable Password | Enter the enable password if it is different from your login password. |
| Same as login password | Check this check box if your enable password is the same as your login password. |

Related Topics

[Troubleshoot Connectivity Issues in a Trustsec-Enabled Network with SXP-IP Mappings](#), on page 885
[Support for SXP](#), on page 7

IP User SGT

The following table describes the fields on the IP User SGT page, which you use to compare IP-SGT values on a device with an ISE assigned SGT. The navigation path for this page is: **Operations > Troubleshoot > Diagnostic Tools > TrustSec Tools > IP User SGT**.

Table 177: IP User SGT

| Option | Usage Guidelines |
|-------------------|--|
| Enter Information | |
| Network Device IP | Enter the IP address of the network device. |
| Filter Results | |
| Username | Enter the username of the user whose records you want to troubleshoot. |
| User IP Address | Enter the IP address of the user whose records you want to troubleshoot. |
| SGT | Enter the user SGT value. |

Related Topics

[Troubleshoot Connectivity Issues in a TrustSec-Enabled Network with IP-SGT Mappings](#), on page 886
[Security Groups Configuration](#), on page 802

Device SGT Settings

The following table describes the fields on the Device SGT page, which you use to compare the device SGT with the most recently assigned value. The navigation path for this page is: **Operations > Troubleshoot > Diagnostic Tools > Trustsec Tools > Device SGT**.

Table 178: Device SGT Settings

| Option | Usage Guidelines |
|---|---|
| Enter Information | |
| Network Device IPs (comma-separated list) | Enter the network device IP addresses (whose device SGT you want to compare with an ISE-assigned device SGT) separated by commas. |
| Common Connection Parameters | |

| Option | Usage Guidelines |
|----------------------------------|---|
| Use Common Connection Parameters | <p>Select this check box to use the following common connection parameters for comparison:</p> <ul style="list-style-type: none"> • Username—Enter the username of the network device. • Password—Enter the password. • Protocol—Choose the protocol. <p>Note Telnet is the default option. If you choose SSHv2, SSH connections must be enabled on the network device.</p> <ul style="list-style-type: none"> • Port—Enter the port number. The default port number for Telnet is 23 and SSH is 22. |
| Enable Password | Enter the enable password if it is different from your login password. |
| Same as login password | Select this check box if your enable password is the same as your login password. |

Related Topics

[Troubleshoot Connectivity Issues in a TrustSec-Enabled Network by Comparing Device SGT Mappings](#), on page 886

[Device SGT Tool](#), on page 886

Progress Details Settings

The following table describes the fields on the Progress Details page, which is displayed when you click the **User Input Required** button in any of the diagnostic tools. This page displays detailed troubleshooting information. The navigation path for this page is: **Operations > Troubleshoot > Diagnostic Tools > Any Diagnostic Tool**.

Table 179: Progress Details Settings

| Option | Usage Guidelines |
|--|--|
| Specify Connection Parameters for Network Device a.b.c.d | |
| Username | Enter the username for logging in to the network device. |
| Password | Enter the password. |

| Option | Usage Guidelines |
|---|--|
| Protocol | Choose the protocol.

Note Telnet is the default option. If you choose SSHv2, you must ensure that SSH connections are enabled on the network device. |
| Port | Enter the port number. |
| Enable Password | Enter the enable password. |
| Same As Login Password | Check this check box if the enable password is the same as the login password. |
| Use Console Server | Select this check box to use the console server. |
| Console IP Address | (If the Use Console Server check box is selected)
Enter the console IP address. |
| Advanced (Use if there is an “Expect timeout error” or the device has non-standard prompt strings)
Note The Advanced options appear only for some of the troubleshooting tools. | |
| Username Expect String | Enter the string that the network device uses to prompt for username; for example, Username:, Login:, and so on. |
| Password Expect String | Enter the string that the network device uses to prompt for password; for example, Password:. |
| Prompt Expect String | Enter the prompt that the network device uses. For example, #, >, and @. |
| Authentication Failure Expect String | Enter the string that the network device returns when there is an authentication failure; for example, Incorrect password, Login invalid, and so on. |

Related Topics

[Troubleshoot Unexpected RADIUS Authentication Results](#), on page 878

[Execute Cisco IOS show Commands to Check Configuration](#), on page 879

[Troubleshoot Network Device Configuration Issues](#), on page 880

[Troubleshoot Connectivity Issues in a Trustsec-Enabled Network with SXP-IP Mappings](#), on page 885

[Troubleshoot Connectivity Issues in a TrustSec-Enabled Network with IP-SGT Mappings](#), on page 886

[Diagnostic Troubleshooting Tools](#), on page 878

Results Summary

The following table describes the fields on the results summary page, which is displayed as a result when you use any diagnostic tool.

Table 180: RADIUS Authentication Troubleshooting Results Summary

| Option | Usage Guidelines |
|--------------------------|---|
| Diagnosis and Resolution | |
| Diagnosis | The diagnosis for the problem is listed here. |
| Resolution | The steps for resolution of the problem are detailed here. |
| Troubleshooting Summary | |
| Summary | A step-by-step summary of troubleshooting information is provided here. You can expand any step to view further details.

Any configuration errors are indicated by red text. |

Related Topics

[Troubleshoot Unexpected RADIUS Authentication Results](#), on page 878

[The RADIUS Authentication Troubleshooting Tool](#), on page 878



CHAPTER 34

Network Access Flows

- [Password-Based Authentication, on page 1169](#)
- [RADIUS Protocol Support in Cisco ISE, on page 1170](#)
- [Network Access for Users, on page 1170](#)

Password-Based Authentication

Authentication verifies user information to confirm user identity. Traditional authentication uses a name and a fixed password. This is the most popular, simplest, and least-expensive method of authentication. The disadvantage is that this information can be told to someone else, guessed, or captured. An approach that uses simple, unencrypted usernames and passwords is not considered a strong authentication mechanism, but it can be sufficient for low-authorization or low-privilege levels such as Internet access.

Secure Authentication Using Encrypted Passwords and Cryptographic Techniques

You should use encryption to reduce the risk of password capture on the network. Client and server access control protocols, such as RADIUS, encrypt passwords to prevent them from being captured within a network. However, RADIUS operates only between the authentication, authorization, and accounting (AAA) client and Cisco ISE. Before this point in the authentication process, unauthorized persons can obtain cleartext passwords such as in the following examples:

- In the communication between an end-user client that dials up over a phone line.
- On an ISDN line that terminates at a network access server.
- Over a Telnet session between an end-user client and the hosting device

More-secure methods use cryptographic techniques, such as those used inside the Challenge Authentication Handshake Protocol (CHAP), one-time password (OTP), and advanced EAP-based protocols. Cisco ISE supports a variety of these authentication methods.

Authentication Methods and Authorization Privileges

A fundamental implicit relationship exists between authentication and authorization. The more authorization privileges that are granted to a user, the stronger the authentication should be. Cisco ISE supports this relationship by providing various methods of authentication.

RADIUS Protocol Support in Cisco ISE

RADIUS is a client/server protocol through which remote-access servers communicate with a central server to authenticate dial-in users and authorize their access to the requested system or service. You can use RADIUS to maintain user profiles in a central database that all remote servers can share. This protocol provides better security, and you can use it to set up a policy that is applied at a single administered network point.

RADIUS also functions as a RADIUS client in Cisco ISE to proxy requests to a remote RADIUS server, and it provides Change of Authorization (CoA) activities during an active session.

Cisco ISE supports RADIUS protocol flow according to RFC 2865 and generic support for all general RADIUS attributes as described in RFC 2865 and its extension. Cisco ISE supports parsing of vendor-specific attributes only for vendors that are defined in the Cisco ISE dictionary.

RADIUS interface supports the following attribute data types that are defined in RFC 2865:

- Text (Unicode Transformation Format [UTF])
- String (binary)
- Address (IP)
- Integer
- Time

[ISE Community Resource](#)

For information about the network access attributes supported by Cisco ISE, see [ISE Network Access Attributes](#).

Network Access for Users

For network access, a host connects to the network device and requests to use network resources. The network device identifies the newly connected host, and, using the RADIUS protocol as a transport mechanism, requests Cisco ISE to authenticate and authorize the user.

Cisco ISE supports network access flows depending on the protocol that is transported over the RADIUS protocol.

RADIUS-Based Protocols Without EAP

RADIUS-based protocols that do not include EAP include the following:

- Password Authentication Protocol (PAP)

- CHAP
- Microsoft Challenge Handshake Authentication Protocol version 1 (MS-CHAPv1)
- MS-CHAP version 2 (MS-CHAPv2)

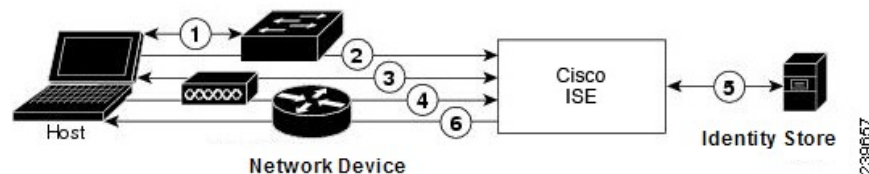
RADIUS-Based Non-EAP Authentication Flow

This section describes RADIUS-based flow without EAP authentication. RADIUS-based flow with PAP authentication occurs in the following process:

1. A host connects to a network device.
2. The network device sends a RADIUS request (Access-Request) to Cisco ISE that contains RADIUS attributes that are appropriate to the specific protocol that is being used (PAP, CHAP, MS-CHAPv1, or MS-CHAPv2).
3. Cisco ISE uses an identity store to validate user credentials.
4. A RADIUS response (Access-Accept or Access-Reject) is sent to the network device that will apply the decision.

The following figure shows a RADIUS-based authentication without EAP.

Figure 74: RADIUS-Based Authentication Without EAP



The non-EAP protocols supported by Cisco ISE are:

Password Authentication Protocol

PAP provides a simple method for users to establish their identity by using a two-way handshake. The PAP password is encrypted with a shared secret and is the least sophisticated authentication protocol. PAP is not a strong authentication method because it offers little protection from repeated trial-and-error attacks.

RADIUS-Based PAP Authentication in Cisco ISE

Cisco ISE checks the username and password pair against the identity stores, until it eventually acknowledges the authentication or terminates the connection.

You can use different levels of security concurrently with Cisco ISE for different requirements. PAP applies a two-way handshaking procedure. If authentication succeeds, Cisco ISE returns an acknowledgment; otherwise, Cisco ISE terminates the connection or gives the originator another chance.

The originator is in total control of the frequency and timing of the attempts. Therefore, any server that can use a stronger authentication method will offer to negotiate that method prior to PAP. RFC 1334 defines PAP.

Cisco ISE supports standard RADIUS PAP authentication that is based on the RADIUS UserPassword attribute. RADIUS PAP authentication is compatible with all identity stores.

The RADIUS-with-PAP-authentication flow includes logging of passed and failed attempts.

Challenge Handshake Authentication Protocol

CHAP uses a challenge-response mechanism with one-way encryption on the response. CHAP enables Cisco ISE to negotiate downward from the most-secure to the least-secure encryption mechanism, and it protects passwords that are transmitted in the process. CHAP passwords are reusable. If you are using the Cisco ISE internal database for authentication, you can use PAP or CHAP. CHAP does not work with the Microsoft user database. Compared to RADIUS PAP, CHAP allows a higher level of security for encrypting passwords when communicating from an end-user client to the AAA client.

Cisco ISE supports standard RADIUS CHAP authentication that is based on the RADIUS ChapPassword attribute. Cisco ISE supports RADIUS CHAP authentication only with internal identity stores.

Microsoft Challenge Handshake Authentication Protocol Version 1

Cisco ISE supports the RADIUS MS-CHAPv1 authentication and change-password features. RADIUS MS-CHAPv1 contains two versions of the change-password feature: Change-Password-V1 and Change-Password-V2. Cisco ISE does not support Change-Password-V1 based on the RADIUS MS-CHAP-CPW-1 attribute, and supports only Change-Password-V2 based on the MS-CHAP-CPW-2 attribute. The RADIUS MS-CHAPv1 authentication and change-password features are supported with the following identity sources:

- Internal identity stores
- Microsoft Active Directory identity store

Microsoft Challenge Handshake Authentication Protocol Version 2

The RADIUS MS-CHAPv2 authentication and change-password features are supported with the following identity sources:

- Internal identity stores
- Microsoft Active Directory identity store

RADIUS-Based EAP Protocols

EAP provides an extensible framework that supports various authentication types. This section describes the EAP methods supported by Cisco ISE and contains the following topics:

Simple EAP Methods

- EAP-Message Digest 5
- Lightweight EAP

EAP Methods That Use Cisco ISE Server Certificate for Authentication

- PEAP/EAP-MS-CHAPv2

- PEAP/EAP-GTC
- EAP-FAST/EAP-MS-CHAPv2
- EAP-FAST/EAP-GTC

Apart from the methods listed above, there are EAP methods that use certificates for both server and client authentication.

RADIUS-Based EAP Authentication Flow

Whenever EAP is involved in the authentication process, the process is preceded by an EAP negotiation phase to determine which specific EAP method (and inner method, if applicable) should be used. EAP-based authentication occurs in the following process:

1. A host connects to a network device.
2. The network device sends an EAP Request to the host.
3. The host replies with an EAP Response to the network device.
4. The network device encapsulates the EAP Response that it received from the host into a RADIUS Access-Request (using the EAP-Message RADIUS attribute) and sends the RADIUS Access-Request to Cisco ISE.
5. Cisco ISE extracts the EAP Response from the RADIUS packet and creates a new EAP Request, encapsulates it into a RADIUS Access-Challenge (again, using the EAP-Message RADIUS attribute), and sends it to the network device.
6. The network device extracts the EAP Request and sends it to the host.

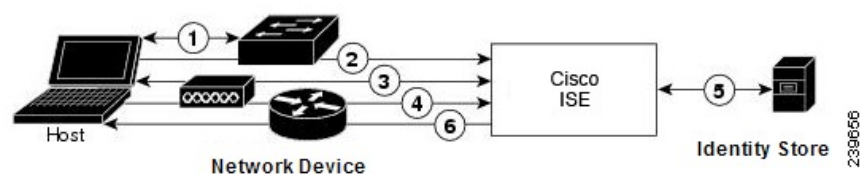
In this way, the host and Cisco ISE indirectly exchange EAP messages (transported over RADIUS and passed through the network device). The initial set of EAP messages that are exchanged in this manner negotiate the specific EAP method that will subsequently be used to perform the authentication.

The EAP messages that are subsequently exchanged are then used to carry the data that is needed to perform the actual authentication. If it is required by the specific EAP authentication method that is negotiated, Cisco ISE uses an identity store to validate user credentials.

After Cisco ISE determines whether the authentication should pass or fail, it sends either an EAP-Success or EAP-Failure message, encapsulated into a RADIUS Access-Accept or Access-Reject message to the network device (and ultimately also to the host).

The following figure shows a RADIUS-based authentication with EAP.

Figure 75: RADIUS-Based Authentication with EAP



Extensible Authentication Protocol-Message Digest 5

Extensible Authentication Protocol-Message Digest 5 (EAP-MD5) provides one-way client authentication. The server sends the client a random challenge. The client proves its identity in a response by encrypting the challenge and its password with MD5. Because a man in the middle could see the challenge and response, EAP-MD5 is vulnerable to dictionary attack when used over an open medium. Because no server authentication occurs, it is also vulnerable to spoofing. Cisco ISE supports EAP-MD5 authentication against the Cisco ISE internal identity store. Host Lookup is also supported when using the EAP-MD5 protocol.

Lightweight Extensible Authentication Protocol

Cisco ISE currently uses Lightweight Extensible Authentication Protocol (LEAP) only for Cisco Aironet wireless networking. If you do not enable this option, Cisco Aironet end-user clients who are configured to perform LEAP authentication cannot access the network. If all Cisco Aironet end-user clients use a different authentication protocol, such as Extensible Authentication Protocol-Transport Layer Security (EAP-TLS), we recommend that you disable this option.



Note If users access your network by using a AAA client that is defined in the *Network Devices* section as a RADIUS (Cisco Aironet) device, then you must enable LEAP, EAP-TLS, or both; otherwise, Cisco Aironet users cannot authenticate.

Protected Extensible Authentication Protocol

Protected Extensible Authentication Protocol (PEAP) provides mutual authentication, ensures confidentiality and integrity to vulnerable user credentials, protects itself against passive (eavesdropping) and active (man-in-the-middle) attacks, and securely generates cryptographic keying material. PEAP is compatible with the IEEE 802.1X standard and RADIUS protocol. Cisco ISE supports PEAP version 0 (PEAPv0) and PEAP version 1 (PEAPv1) with Extensible Authentication Protocol-Microsoft Challenge Handshake Authentication Protocol (EAP-MS-CHAP), Extensible Authentication Protocol-Generic Token Card (EAP-GTC), and EAP-TLS inner methods. The Cisco Secure Services Client (SSC) supplicant supports all of the PEAPv1 inner methods that Cisco ISE supports.

Advantages of Using PEAP

Using PEAP presents these advantages: PEAP is based on TLS, which is widely implemented and has undergone extensive security review. It establishes a key for methods that do not derive keys. It sends an identity within the tunnel. It protects inner method exchanges and the result message. It supports fragmentation.

Supported Supplicants for the PEAP Protocol

PEAP supports these supplicants:

- Microsoft Built-In Clients 802.1X XP
- Microsoft Built-In Clients 802.1X Vista
- Cisco Secure Services Client (SSC), Release 4.0
- Cisco SSC, Release 5.1
- Funk Odyssey Access Client, Release 4.72
- Intel, Release 12.4.0.0

PEAP Protocol Flow

A PEAP conversation can be divided into three parts:

1. Cisco ISE and the peer build a TLS tunnel. Cisco ISE presents its certificate, but the peer does not. The peer and Cisco ISE create a key to encrypt the data inside the tunnel.
2. The inner method determines the flow within the tunnel:
 - EAP-MS-CHAPv2 inner method—EAP-MS-CHAPv2 packets travel inside the tunnel without their headers. The first byte of the header contains the type field. EAP-MS-CHAPv2 inner methods support the change-password feature. You can configure the number of times that the user can attempt to change the password through the Admin portal. User authentication attempts are limited by this number.
 - EAP-GTC inner method—Both PEAPv0 and PEAPv1 support the EAP-GTC inner method. The supported supplicants do not support PEAPv0 with the EAP-GTC inner method. EAP-GTC supports the change-password feature. You can configure the number of times that the user can attempt to change the password through the Admin portal. User authentication attempts are limited by this number.
 - EAP-TLS inner method—The Windows built-in supplicant does not support fragmentation of messages after the tunnel is established, and this affects the EAP-TLS inner method. Cisco ISE does not support fragmentation of the outer PEAP message after the tunnel is established. During tunnel establishment, fragmentation works as specified in PEAP documentation. In PEAPv0, EAP-TLS packet headers are removed, and in PEAPv1, EAP-TLS packets are transmitted unchanged.
 - Extensible Authentication Protocol-type, length, value (EAP-TLV) extension—EAP-TLV packets are transmitted unchanged. EAP-TLV packets travel with their headers inside the tunnel.
3. There is protected acknowledgment of success and failure if the conversation has reached the inner method.

The client EAP message is always carried in the RADIUS Access-Request message, and the server EAP message is always carried in the RADIUS Access-Challenge message. The EAP-Success message is always carried in the RADIUS Access-Accept message. The EAP-Failure message is always carried in the RADIUS Access-Reject message. Dropping the client PEAP message results in dropping the RADIUS client message.



Note Cisco ISE requires acknowledgment of the EAP-Success or EAP-Failure message during PEAPv1 communication. The peer must send back a PEAP packet with empty TLS data field to acknowledge the receipt of success or failure message.

Extensible Authentication Protocol-Flexible Authentication via Secure Tunneling

Extensible Authentication Protocol-Flexible Authentication via Secure Tunneling (EAP-FAST) is an authentication protocol that provides mutual authentication and uses a shared secret to establish a tunnel. The tunnel is used to protect weak authentication methods that are based on passwords. The shared secret, referred to as a Protected Access Credentials (PAC) key, is used to mutually authenticate the client and server while securing the tunnel.

Benefits of EAP-FAST

EAP-FAST provides the following benefits over other authentication protocols:

- Mutual authentication—The EAP server must be able to verify the identity and authenticity of the peer, and the peer must be able to verify the authenticity of the EAP server.
- Immunity to passive dictionary attacks—Many authentication protocols require a password to be explicitly provided, either as cleartext or hashed, by the peer to the EAP server.
- Immunity to man-in-the-middle attacks—In establishing a mutually authenticated protected tunnel, the protocol must prevent adversaries from successfully interjecting information into the conversation between the peer and the EAP server.
- Flexibility to enable support for many different password authentication interfaces such as MS-CHAPv2, Generic Token Card (GTC), and others—EAP-FAST is an extensible framework that allows support of multiple internal protocols by the same server.
- Efficiency—When using wireless media, peers are limited in computational and power resources. EAP-FAST enables the network access communication to be computationally lightweight.
- Minimization of the per-user authentication state requirements of the authentication server—With large deployments, it is typical to have many servers acting as the authentication servers for many peers. It is also highly desirable for a peer to use the same shared secret to secure a tunnel much the same way that it uses the username and password to gain access to the network. EAP-FAST facilitates the use of a single, strong, shared secret by the peer, while enabling servers to minimize the per-user and device state that it must cache and manage.

EAP-FAST Flow

The EAP-FAST protocol flow is always a combination of the following phases:

1. Provisioning phase—This is phase zero of EAP-FAST. During this phase, the peer is provisioned with a unique, strong secret that is referred to as the PAC that is shared between the Cisco ISE and the peer.
2. Tunnel establishment phase—The client and server authenticate each other by using the PAC to establish a fresh tunnel key. The tunnel key is then used to protect the rest of the conversation and provides message confidentiality and with authenticity.
3. Authentication phase—The authentication is processed inside the tunnel and includes the generation of session keys and protected termination. Cisco ISE supports EAP-FAST versions 1 and 1a.



CHAPTER 35

Switch and Wireless LAN Controller Configuration Required to Support Cisco ISE Functions

To ensure Cisco ISE is able to interoperate with network switches and functions from Cisco ISE are successful across the network segment, you need to configure network switches with the necessary NTP, RADIUS/AAA, 802.1X, MAB, and other settings for communication with Cisco ISE.

- [Enable Your Switch to Support Standard Web Authentication, on page 1177](#)
- [Local Username and Password Definition for Synthetic RADIUS Transactions, on page 1178](#)
- [NTP Server Configuration to Ensure Accurate Log and Accounting Timestamps, on page 1178](#)
- [Command to Enable AAA Functions, on page 1178](#)
- [RADIUS Server Configuration on the Switch, on page 1179](#)
- [Command to Enable RADIUS Change of Authorization \(CoA\), on page 1179](#)
- [Command to Enable Device Tracking and DHCP Snooping, on page 1180](#)
- [Command to Enable 802.1X Port-Based Authentication, on page 1180](#)
- [Command to Enable EAP for Critical Authentications, on page 1180](#)
- [Command to Throttle AAA Requests Using Recovery Delay, on page 1181](#)
- [VLAN Definitions Based on Enforcement States, on page 1181](#)
- [Local \(Default\) Access List \(ACL\) Definitions on the Switch, on page 1182](#)
- [Enable Switch Ports for 802.1X and MAB, on page 1183](#)
- [Command to Enable EPM Logging, on page 1185](#)
- [Command to Enable SNMP Traps, on page 1185](#)
- [Command to Enable SNMP v3 Query for Profiling, on page 1185](#)
- [Command to Enable MAC Notification Traps for Profiler to Collect, on page 1186](#)
- [RADIUS Idle-Timeout Configuration on the Switch, on page 1186](#)
- [Wireless Controller Configuration for iOS Supplicant Provisioning, on page 1186](#)
- [Configuring ACLs on the Wireless LAN Controller for Mobile Device Management Interoperability, on page 1187](#)

Enable Your Switch to Support Standard Web Authentication

Ensure that you include the following commands in your switch configuration to enable standard web authentication functions for Cisco ISE, including provisions for URL redirection upon authentication:

```
ip classless

ip route 0.0.0.0 0.0.0.0 10.1.2.3

ip http server

! Must enable HTTP/HTTPS for URL-redirectation on port 80/443

ip http secure-server
```

Local Username and Password Definition for Synthetic RADIUS Transactions

Enter the following command to enable the switch to talk to the Cisco ISE node as though it is the RADIUS server for this network segment:

```
username test-radius password 0 abcde123
```

NTP Server Configuration to Ensure Accurate Log and Accounting Timestamps

Ensure that you specify the same NTP server on the switch as you have set in Cisco ISE by entering the following command:

```
ntp server <IP_address>|<domain_name>
```

Command to Enable AAA Functions

Enter the following commands on the switch to enable the various AAA functions between the switch and Cisco ISE, including 802.1X and MAB authentication functions:

```
aaa new-model

! Creates an 802.1X port-based authentication method list

aaa authentication dot1x default group radius

! Required for VLAN/ACL assignment

aaa authorization network default group radius

! Authentication & authorization for webauth transactions

aaa authorization auth-proxy default group radius

! Enables accounting for 802.1X and MAB authentications
```

```
aaa accounting dot1x default start-stop group radius
!
aaa session-id common
!
aaa accounting update periodic 5
! Update AAA accounting information periodically every 5 minutes
aaa accounting system default start-stop group radius
!
```

RADIUS Server Configuration on the Switch

Configure the switch to interact with Cisco ISE as the RADIUS source server by entering the following commands:

```
!
radius-server <ISE Name>
! ISE Name is the name of the ISE PSN
address ipv4 <ip address> auth-port 1812 acct-port 1813
! IP address is the address of the PSN. This example uses the standard RADIUS ports.
key <passwd>
! passwd is the secret password configured in Cisco ISE
exit
```



Note We recommend that you configure a dead-criteria time of 30 seconds with 3 retries to provide longer response times for RADIUS requests that use Active Directory for authentication.

Command to Enable RADIUS Change of Authorization (CoA)

Specify the settings to ensure the switch is able to appropriately handle RADIUS CoA behavior supporting posture functions on Cisco ISE by entering the following commands:

```
aaa server radius dynamic-author
client <ISE-IP> server-key 0 abcde123
```

**Note**

- Cisco ISE uses port 1700 (Cisco IOS software default) versus RFC default port 3799 for CoA. Existing Cisco Secure ACS 5.x customers may already have this set to port 3799 if they are using CoA as part of an existing ACS implementation.
- Shared secret key should be the same as the one configured on Cisco ISE while adding a network device and the IP address should be a PSN IP address.

Command to Enable Device Tracking and DHCP Snooping

To help provide optional security-oriented functions from Cisco ISE, you can enable device tracking and DHCP snooping for IP substitution in dynamic ACLs on switch ports by entering the following commands:

```
! Optional

ip dhcp snooping

! Required!

! Configure Device Tracking Policy!
device-tracking policy <DT_POLICY_NAME>
no protocol ndp
tracking enable

! Bind it to interface!
interface <interface_id>
device-tracking attach-policy<DT_POLICY_NAME>
```

In RADIUS accounting, the DHCP attributes are not sent by the IOS sensor to Cisco ISE even when DHCP snooping is enabled. In such cases, DHCP snooping should be enabled on the VLAN to make the DHCP active.

Use the following commands to enable DHCP snooping on VLAN:

```
ip dhcp snooping
ip dhcp snooping vlan 1-100
```

Command to Enable 802.1X Port-Based Authentication

Enter the following commands to turn 802.1X authentication on for switch ports, globally:

```
dot1x system-auth-control
```

Command to Enable EAP for Critical Authentications

To support supplicant authentication requests over the LAN, enable EAP for critical authentications (Inaccessible Authentication Bypass) by entering the following command:

```
dot1x critical eapol
```


Command to Throttle AAA Requests Using Recovery Delay

When a critical authentication recovery event takes place, you can configure the switch to automatically introduce a delay (in milliseconds) to ensure Cisco ISE is able to launch services again following recovery by entering the following command:

```
authentication critical recovery delay 1000
```

VLAN Definitions Based on Enforcement States

Enter the following commands to define the VLAN names, numbers, and Switch Virtual Interfaces (SVIs) based on known enforcement states in your network. Create the respective VLAN interfaces to enable routing between networks. This can be especially helpful to handle multiple sources of traffic passing over the same network segments from both the endpoints (such as PC, laptop) and the IP phone through which the endpoint is connected to the network, for example:

```
vlan <VLAN_number>

name ACCESS!

vlan <VLAN_number>

name VOICE

!

interface <VLAN_number>

description ACCESS

ip address 10.1.2.3 255.255.255.0

ip helper-address <DHCP_Server_IP_address>

ip helper-address <Cisco_ISE_IP_address>

!

interface <VLAN_number>

description VOICE

ip address 10.2.3.4 255.255.255.0

ip helper-address <DHCP_Server_IP_address>
```

Local (Default) Access List (ACL) Definitions on the Switch

Enable these functions on older switches (with Cisco IOS software releases earlier than 12.2(55)SE) to ensure Cisco ISE is able to perform the dynamic ACL updates required for authentication and authorization by entering the following commands:

```
ip access-list extended ACL-ALLOW

  permit ip any any

!

ip access-list extended ACL-DEFAULT

  remark DHCP

  permit udp any eq bootpc any eq bootps

  remark DNS

  permit udp any any eq domain

  remark Ping

  permit icmp any any

  remark Ping

  permit icmp any any

  remark PXE / TFTP

  permit udp any any eq tftp

  remark Allow HTTP/S to ISE and WebAuth portal

  permit tcp any host <Cisco_ISE_IP_address> eq www

  permit tcp any host <Cisco_ISE_IP_address> eq 443

  permit tcp any host <Cisco_ISE_IP_address> eq 8443

  permit tcp any host <Cisco_ISE_IP_address> eq 8905
```

```
permit udp any host <Cisco_ISE_IP_address> eq 8905

permit udp any host <Cisco_ISE_IP_address> eq 8906

permit tcp any host <Cisco_ISE_IP_address> eq 8080

permit udp any host <Cisco_ISE_IP_address> eq 9996

remark Drop all the rest

deny ip any any log

!

! The ACL to allow URL-redirection for WebAuth

ip access-list extended ACL-WEBAUTH-REDIRECT

permit tcp any any eq www

permit tcp any any eq 443
```



Note This configuration on the Wireless Controller may increase CPU utilization and raises the risk of system instability. This is an IOS issue and does not adversely affect Cisco ISE.

Enable Switch Ports for 802.1X and MAB

To enable switch ports for 802.1X and MAB:

-
- Step 1** Enter the interface configuration mode for all of the access switch ports:
interface range FastEthernet0/1-8
- Step 2** Enable the switch ports for access mode (instead of trunk mode):
switchport mode access
- Step 3** Statically configure the access VLAN. This provides local provisioning for the access VLANs and is required for open-mode authentication:
switchport access vlan <VLAN_number>

- Step 4** Statically configure the voice VLAN:
switchport voice vlan <VLAN_number>
- Step 5** Enable open-mode authentication. Open-mode allows traffic to be bridged onto the data and voice VLANs before authentication is completed. We strongly recommend using a port-based ACL in a production environment to prevent unauthorized access.
 Enabling open-mode authentication also enables pre-authentication access before the AAA server response, subject to the port ACL.
authentication open
- Step 6** Apply a port-based ACL to determine which traffic should be bridged by default from unauthenticated endpoints onto the access VLAN. Because you should allow all access first and enforce policy later, you should apply ACL-ALLOW to permit all traffic through the switch port. You have already created a default Cisco ISE authorization to allow all traffic for now because we want complete visibility and do not want to impact the existing end-user experience yet. An ACL must be configured to prepend dynamic ACLs from AAA server.
ip access-group ACL-ALLOW in
- Note** Prior to Cisco IOS software Release 12.2(55)SE on DSBUs switches, a port ACL is required for dynamic ACLs from a RADIUS AAA server to be applied. Failure to have a default ACL will result in assigned dynamic ACLs being ignored by the switch. With Cisco IOS software Release 12.2(55)SE, a default ACL will be automatically generated and applied.
- Note** We are using ACL-ALLOW at this point in the lab because we want to enable 802.1X port-based authentication, but without any impact to the existing network. In a later exercise, we will apply a different ACL-DEFAULT, which blocks undesired traffic for a production environment.
- Step 7** Enable Multi-Auth host mode. Multi-Auth is essentially a superset of Multi-Domain Authentication (MDA). MDA only allows a single endpoint in the data domain. When multi-auth is configured, a single authenticated phone is allowed in the voice domain (as with MDA) but an unlimited number of data devices can be authenticated in the data domain. Allow voice and multiple endpoints on same physical access port
authentication host-mode multi-auth
- Note** Multiple data devices (whether virtualized devices or physical devices connected to a hub) behind an IP phone can exacerbate the access ports' physical link-state awareness.
- Step 8** Enable various authentication method options with the following commands:
 Enable re-authentication:
authentication periodic
 Enable re-authentication via RADIUS Session-Timeout:
authentication timer reauthenticate server
authentication event fail action next-method
 Configure critical authentication vlan method in case of dead server:
authentication event server dead action reinitialize vlan <VLAN_number>
authentication event server alive action reinitialize
 Configure IOS Flex-Auth authentication for 802.1X and MAB:
authentication order dot1x mab
authentication priority dot1x mab
- Step 9** Enable 802.1X port control on the switchport:

```
authentication port-control auto
authentication violation restrict
```

Step 10 Enable MAC Authentication Bypass (MAB):
mab

Step 11 Enable 802.1X on the switchport:
dot1x pae authenticator

Step 12 Set the retransmit period to 10 seconds:
dot1x timeout tx-period 10

Note The 802.1X tx-period timeout should be set to 10 seconds. Do not change this unless you understand the implications.

Step 13 Enable the portfast feature:
spanning-tree portfast

Command to Enable EPM Logging

Set up standard logging functions on the switch to support possible troubleshooting and recording for Cisco ISE functions:

```
epm logging
```

Command to Enable SNMP Traps

Ensure the switch is able to receive SNMP trap transmissions from Cisco ISE over the appropriate VLAN in this network segment:

```
snmp-server community public RO
```

```
snmp-server trap-source <VLAN_number>
```

Command to Enable SNMP v3 Query for Profiling

Configure the switch to ensure SNMP v3 polling takes place as intended to support Cisco ISE profiling services using the following commands. Prior to that configure the SNMP settings in the Cisco ISE GUI in the **SNMP Settings** window. The navigation path for the window is **AdministrationNetwork ResourcesNetwork DevicesAdd | EditSNMP Settings** .

```
Snmp-server user <name> <group> v3 auth md5 <string> priv des <string>
```

```
snmp-server group <group> v3 priv
```

```
snmp-server group <group> v3 priv context vlan-1
```



Note The `snmp-server group <group> v3 priv context vlan-1` command must be configured for each context. The `snmp show context` command lists all the context information.

If the SNMP request times out and there is no connectivity issue, then you can increase the timeout value.

Command to Enable MAC Notification Traps for Profiler to Collect

Configure your switch to transmit the appropriate MAC notification traps so that the Cisco ISE profiler function is able to collect information on network endpoints:

```
mac address-table notification change
```

```
mac address-table notification mac-move
```

```
snmp trap mac-notification change added
```

```
snmp trap mac-notification change removed
```

RADIUS Idle-Timeout Configuration on the Switch

To configure the RADIUS idle-timeout on a switch, use the following command:

```
Switch(config-if)# authentication timer inactivity
```

where *inactivity* is interval of inactivity in seconds, after which the client activity is considered unauthorized.

In Cisco ISE, you can enable this option for any authorization policies to which such a session inactivity timer should apply. Choose **Policy > Policy Elements > Results > Authorization > Authorization Profiles**.

Wireless Controller Configuration for iOS Supplicant Provisioning

For Single SSID

To support Apple iOS-based devices (iPhone or iPad) switching from one SSID to another on the same wireless access point, configure the Wireless Controller to enable the **FAST SSID change** function. This function helps ensure iOS-based devices are able to more quickly switch between SSIDs.

For Dual SSID BYOD

Fast SSID must be enabled to support dual SSID BYOD. When fast SSID changing is enabled, the Wireless Controller allows clients to move faster between SSIDs. When fast SSID is enabled, the client entry is not cleared and the delay is not enforced. For more information about configuring fast SSID on a Cisco Wireless Controller, see the [Cisco Wireless Controller Configuration Guide](#).

Example Wireless Controller Configuration

```
WLC (config)# FAST SSID change
```

You might see the following error message while trying to connect to a wireless network for some of the Apple iOS-based devices:

```
Could not scan for Wireless Networks.
```

You can ignore this error message because this does not affect the authentication of the device.

Configuring ACLs on the Wireless LAN Controller for Mobile Device Management Interoperability

You must configure ACLs on the Wireless Controller for use in an authorization policy to redirect nonregistered devices and certificate provisioning. Your ACLs must be in the following sequence.

-
- Step 1** Allow all outbound traffic from the server to the client.
 - Step 2** (Optional) Allow ICMP inbound traffic from the client to the server for troubleshooting.
 - Step 3** Allow access to the MDM server for unregistered and noncompliant devices to download the MDM agent and proceed with compliance checks.
 - Step 4** Allow all inbound traffic from the client to the server to Cisco ISE for the web portal and supplicant, and certificate provisioning flows.
 - Step 5** Allow inbound DNS traffic from the client to the server for name resolution.
 - Step 6** Allow inbound DHCP traffic from the client to the server for IP addresses.
 - Step 7** Deny all inbound traffic from the client to the server to corporate resources for redirection to Cisco ISE (as per your company policy).
 - Step 8** (Optional) Permit the rest of the traffic.
-

Example

The following example shows the ACLs for redirecting a nonregistered device to the BYOD flow. In this example, the Cisco ISE IP address is 10.35.50.165, the internal corporate network IP addresses are 192.168.0.0 and 172.16.0.0 (to redirect), and the MDM server subnet is 204.8.168.0.

Figure 76: ACLs for Redirecting Nonregistered Device

| General | | | | | | | | | |
|------------------|--------|----------------|---------------------|----------|-------------|-------------|------|-----------|----------------|
| Access List Name | | NSP-ACL | | | | | | | |
| Deny Counters | | 0 | | | | | | | |
| Seq | Action | Source IP/Mask | Destination IP/Mask | Protocol | Source Port | Dest Port | DSCP | Direction | Number of Hits |
| 1 | Permit | 0.0.0.0 / | 0.0.0.0 / | Any | Any | Any | Any | Outbound | 150720 |
| 2 | Permit | 0.0.0.0 / | 0.0.0.0 / | ICMP | Any | Any | Any | Inbound | 7227 |
| 3 | Permit | 0.0.0.0 / | 204.8.168.0 / | Any | Any | Any | Any | Any | 17626 |
| 4 | Permit | 0.0.0.0 / | 255.255.255.0 / | Any | Any | Any | Any | Inbound | 7505 |
| 5 | Permit | 0.0.0.0 / | 10.35.50.165 / | Any | Any | Any | Any | Inbound | 7505 |
| 6 | Permit | 0.0.0.0 / | 255.255.255.255 / | UDP | Any | DNS | Any | Inbound | 2864 |
| 7 | Permit | 0.0.0.0 / | 0.0.0.0 / | UDP | Any | DHCP Server | Any | Inbound | 0 |
| 8 | Deny | 0.0.0.0 / | 192.168.0.0 / | Any | Any | Any | Any | Inbound | 0 |
| 9 | Deny | 0.0.0.0 / | 255.255.0.0 / | Any | Any | Any | Any | Inbound | 4 |
| 10 | Deny | 0.0.0.0 / | 172.16.0.0 / | Any | Any | Any | Any | Inbound | 457 |
| 11 | Deny | 0.0.0.0 / | 255.240.0.0 / | Any | Any | Any | Any | Inbound | 1256 |
| 12 | Deny | 0.0.0.0 / | 10.0.0.0 / | Any | Any | Any | Any | Inbound | 11310 |
| 13 | Deny | 0.0.0.0 / | 173.194.0.0 / | Any | Any | Any | Any | Inbound | 0 |
| 14 | Deny | 0.0.0.0 / | 255.255.0.0 / | Any | Any | Any | Any | Any | 0 |
| 15 | Permit | 0.0.0.0 / | 171.68.0.0 / | Any | Any | Any | Any | Any | 71819 |
| 16 | Permit | 0.0.0.0 / | 255.252.0.0 / | Any | Any | Any | Any | Any | 0 |
| 17 | Permit | 0.0.0.0 / | 171.71.181.0 / | Any | Any | Any | Any | Any | 0 |
| 18 | Permit | 0.0.0.0 / | 255.255.255.0 / | Any | Any | Any | Any | Any | 0 |
| 19 | Permit | 0.0.0.0 / | 0.0.0.0 / | Any | Any | Any | Any | Any | 71819 |
| 20 | Permit | 0.0.0.0 / | 0.0.0.0 / | Any | Any | Any | Any | Any | 71819 |



CHAPTER 36

Supported Management Information Bases for Cisco ISE Endpoint Profiler

- [IF-MIB, on page 1189](#)
- [SNMPv2-MIB, on page 1190](#)
- [IP-MIB, on page 1190](#)
- [CISCO-CDP-MIB, on page 1190](#)
- [CISCO-VTP-MIB, on page 1191](#)
- [CISCO-STACK-MIB, on page 1192](#)
- [BRIDGE-MIB, on page 1192](#)
- [OLD-CISCO-INTERFACE-MIB, on page 1192](#)
- [CISCO-LWAPP-AP-MIB, on page 1192](#)
- [CISCO-LWAPP-DOT11-CLIENT-MIB, on page 1194](#)
- [CISCO-AUTH-FRAMEWORK-MIB, on page 1194](#)
- [EEE8021-PAE-MIB: RFC IEEE 802.1X, on page 1195](#)
- [HOST-RESOURCES-MIB, on page 1195](#)
- [LLDP-MIB, on page 1195](#)

IF-MIB

| Object | OID |
|---------------|---------------------|
| ifIndex | 1.3.6.1.2.1.2.2.1.1 |
| ifDescr | 1.3.6.1.2.1.2.2.1.2 |
| ifType | 1.3.6.1.2.1.2.2.1.3 |
| ifSpeed | 1.3.6.1.2.1.2.2.1.5 |
| ifPhysAddress | 1.3.6.1.2.1.2.2.1.6 |
| ifAdminStatus | 1.3.6.1.2.1.2.2.1.7 |
| ifOperStatus | 1.3.6.1.2.1.2.2.1.8 |

SNMPv2-MIB

| Object | OID |
|-----------------|-------------------|
| system | 1.3.6.1.2.1.1 |
| sysDescr | 1.3.6.1.2.1.1.1.0 |
| sysObjectID | 1.3.6.1.2.1.1.2.0 |
| sysUpTime | 1.3.6.1.2.1.1.3.0 |
| sysContact | 1.3.6.1.2.1.1.4.0 |
| sysName | 1.3.6.1.2.1.1.5.0 |
| sysLocation | 1.3.6.1.2.1.1.6.0 |
| sysServices | 1.3.6.1.2.1.1.7.0 |
| sysORLastChange | 1.3.6.1.2.1.1.8.0 |
| sysORTable | 1.3.6.1.2.1.1.9.0 |

IP-MIB

| Object | OID |
|----------------------------|----------------------|
| ipAdEntIfIndex | 1.3.6.1.2.1.4.20.1.2 |
| ipAdEntNetMask | 1.3.6.1.2.1.4.20.1.3 |
| ipNetToMediaPhysAddress | 1.3.6.1.2.1.4.22.1.2 |
| ipNetToPhysicalPhysAddress | 1.3.6.1.2.1.4.35.1.4 |

CISCO-CDP-MIB

| Object | OID |
|---------------------|------------------------------|
| cdpCacheEntry | 1.3.6.1.4.1.9.9.23.1.2.1.1 |
| cdpCacheIfIndex | 1.3.6.1.4.1.9.9.23.1.2.1.1.1 |
| cdpCacheDeviceIndex | 1.3.6.1.4.1.9.9.23.1.2.1.1.2 |
| cdpCacheAddressType | 1.3.6.1.4.1.9.9.23.1.2.1.1.3 |
| cdpCacheAddress | 1.3.6.1.4.1.9.9.23.1.2.1.1.4 |

| Object | OID |
|-------------------------------|-------------------------------|
| cdpCacheVersion | 1.3.6.1.4.1.9.9.23.1.2.1.1.5 |
| cdpCacheDeviceId | 1.3.6.1.4.1.9.9.23.1.2.1.1.6 |
| cdpCacheDevicePort | 1.3.6.1.4.1.9.9.23.1.2.1.1.7 |
| cdpCachePlatform | 1.3.6.1.4.1.9.9.23.1.2.1.1.8 |
| cdpCacheCapabilities | 1.3.6.1.4.1.9.9.23.1.2.1.1.9 |
| cdpCacheVTPMgmtDomain | 1.3.6.1.4.1.9.9.23.1.2.1.1.10 |
| cdpCacheNativeVLAN | 1.3.6.1.4.1.9.9.23.1.2.1.1.11 |
| cdpCacheDuplex | 1.3.6.1.4.1.9.9.23.1.2.1.1.12 |
| cdpCacheApplianceID | 1.3.6.1.4.1.9.9.23.1.2.1.1.13 |
| cdpCacheVlanID | 1.3.6.1.4.1.9.9.23.1.2.1.1.14 |
| cdpCachePowerConsumption | 1.3.6.1.4.1.9.9.23.1.2.1.1.15 |
| cdpCacheMTU | 1.3.6.1.4.1.9.9.23.1.2.1.1.16 |
| cdpCacheSysName | 1.3.6.1.4.1.9.9.23.1.2.1.1.17 |
| cdpCacheSysObjectID | 1.3.6.1.4.1.9.9.23.1.2.1.1.18 |
| cdpCachePrimaryMgmtAddrType | 1.3.6.1.4.1.9.9.23.1.2.1.1.19 |
| cdpCachePrimaryMgmtAddr | 1.3.6.1.4.1.9.9.23.1.2.1.1.20 |
| cdpCacheSecondaryMgmtAddrType | 1.3.6.1.4.1.9.9.23.1.2.1.1.21 |
| cdpCacheSecondaryMgmtAddr | 1.3.6.1.4.1.9.9.23.1.2.1.1.22 |
| cdpCachePhysLocation | 1.3.6.1.4.1.9.9.23.1.2.1.1.23 |
| cdpCacheLastChange | 1.3.6.1.4.1.9.9.23.1.2.1.1.24 |

CISCO-VTP-MIB

| Object | OID |
|----------------|---------------------------------|
| vtpVlanIfIndex | 1.3.6.1.4.1.9.9.46.1.3.1.1.18.1 |
| vtpVlanName | 1.3.6.1.4.1.9.9.46.1.3.1.1.4.1 |
| vtpVlanState | 1.3.6.1.4.1.9.9.46.1.3.1.1.2.1 |

CISCO-STACK-MIB

| Object | OID |
|--------------|-----------------------------|
| portIfIndex | 1.3.6.1.4.1.9.5.1.4.1.1.11 |
| vlanPortVlan | 1.3.6.1.4.1.9.5.1.9.3.1.3.1 |

BRIDGE-MIB

| Object | OID |
|----------------------|------------------------|
| dot1dTpFdbPort | 1.3.6.1.2.1.17.4.3.1.2 |
| dot1dBasePortIfIndex | 1.3.6.1.2.1.17.1.4.1.2 |

OLD-CISCO-INTERFACE-MIB

| Object | OID |
|-------------|--------------------------|
| locIfReason | 1.3.6.1.4.1.9.2.2.1.1.20 |

CISCO-LWAPP-AP-MIB

| Object | OID |
|------------------------------|-----------------------------|
| cLApEntry | 1.3.6.1.4.1.9.9.513.1.1.1 |
| cLApSysMacAddress | 1.3.6.1.4.1.9.9.513.1.1.1.1 |
| cLApIfMacAddress | 1.3.6.1.4.1.9.9.513.1.1.1.2 |
| cLApMaxNumberOfDot11Slots | 1.3.6.1.4.1.9.9.513.1.1.1.3 |
| cLApEntPhysicalIndex | 1.3.6.1.4.1.9.9.513.1.1.1.4 |
| cLApName | 1.3.6.1.4.1.9.9.513.1.1.1.5 |
| cLApUpTime | 1.3.6.1.4.1.9.9.513.1.1.1.6 |
| cLLwappUpTime | 1.3.6.1.4.1.9.9.513.1.1.1.7 |
| cLLwappJoinTakenTime | 1.3.6.1.4.1.9.9.513.1.1.1.8 |
| cLApMaxNumberOfEthernetSlots | 1.3.6.1.4.1.9.9.513.1.1.1.9 |

| Object | OID |
|------------------------------------|--------------------------------|
| cLApPrimaryControllerAddressType | 1.3.6.1.4.1.9.9.513.1.1.1.1.10 |
| cLApPrimaryControllerAddress | 1.3.6.1.4.1.9.9.513.1.1.1.1.11 |
| cLApSecondaryControllerAddressType | 1.3.6.1.4.1.9.9.513.1.1.1.1.12 |
| cLApSecondaryControllerAddress | 1.3.6.1.4.1.9.9.513.1.1.1.1.13 |
| cLApTertiaryControllerAddressType | 1.3.6.1.4.1.9.9.513.1.1.1.1.14 |
| cLApTertiaryControllerAddress | 1.3.6.1.4.1.9.9.513.1.1.1.1.15 |
| cLApLastRebootReason | 1.3.6.1.4.1.9.9.513.1.1.1.1.16 |
| cLApEncryptionEnable | 1.3.6.1.4.1.9.9.513.1.1.1.1.17 |
| cLApFailoverPriority | 1.3.6.1.4.1.9.9.513.1.1.1.1.18 |
| cLApPowerStatus | 1.3.6.1.4.1.9.9.513.1.1.1.1.19 |
| cLApTelnetEnable | 1.3.6.1.4.1.9.9.513.1.1.1.1.20 |
| cLApSshEnable | 1.3.6.1.4.1.9.9.513.1.1.1.1.21 |
| cLApPreStdStateEnabled | 1.3.6.1.4.1.9.9.513.1.1.1.1.22 |
| cLApPwrInjectorStateEnabled | 1.3.6.1.4.1.9.9.513.1.1.1.1.23 |
| cLApPwrInjectorSelection | 1.3.6.1.4.1.9.9.513.1.1.1.1.24 |
| cLApPwrInjectorSwMacAddr | 1.3.6.1.4.1.9.9.513.1.1.1.1.25 |
| cLApWipsEnable | 1.3.6.1.4.1.9.9.513.1.1.1.1.26 |
| cLApMonitorModeOptimization | 1.3.6.1.4.1.9.9.513.1.1.1.1.27 |
| cLApDomainName | 1.3.6.1.4.1.9.9.513.1.1.1.1.28 |
| cLApNameServerAddressType | 1.3.6.1.4.1.9.9.513.1.1.1.1.29 |
| cLApNameServerAddress | 1.3.6.1.4.1.9.9.513.1.1.1.1.30 |
| cLApAMSDUEnable | 1.3.6.1.4.1.9.9.513.1.1.1.1.31 |
| cLApEncryptionSupported | 1.3.6.1.4.1.9.9.513.1.1.1.1.32 |
| cLApRogueDetectionEnabled | 1.3.6.1.4.1.9.9.513.1.1.1.1.33 |

CISCO-LWAPP-DOT11-CLIENT-MIB

| Object | OID |
|----------------------------|--------------------------------|
| cldcClientEntry | 1.3.6.1.4.1.9.9.599.1.3.1.1 |
| cldcClientMacAddress | 1.3.6.1.4.1.9.9.599.1.3.1.1.1 |
| cldcClientStatus | 1.3.6.1.4.1.9.9.599.1.3.1.1.2 |
| cldcClientWlanProfileName | 1.3.6.1.4.1.9.9.599.1.3.1.1.3 |
| cldcClientWgbStatus | 1.3.6.1.4.1.9.9.599.1.3.1.1.4 |
| cldcClientWgbMacAddress | 1.3.6.1.4.1.9.9.599.1.3.1.1.5 |
| cldcClientProtocol | 1.3.6.1.4.1.9.9.599.1.3.1.1.6 |
| cldcAssociationMode | 1.3.6.1.4.1.9.9.599.1.3.1.1.7 |
| cldcApMacAddress | 1.3.6.1.4.1.9.9.599.1.3.1.1.8 |
| cldcIfType | 1.3.6.1.4.1.9.9.599.1.3.1.1.9 |
| cldcClientIPAddress | 1.3.6.1.4.1.9.9.599.1.3.1.1.10 |
| cldcClientNacState | 1.3.6.1.4.1.9.9.599.1.3.1.1.11 |
| cldcClientQuarantineVLAN | 1.3.6.1.4.1.9.9.599.1.3.1.1.12 |
| cldcClientAccessVLAN | 1.3.6.1.4.1.9.9.599.1.3.1.1.13 |
| cldcClientLoginTime | 1.3.6.1.4.1.9.9.599.1.3.1.1.14 |
| cldcClientUpTime | 1.3.6.1.4.1.9.9.599.1.3.1.1.15 |
| cldcClientPowerSaveMode | 1.3.6.1.4.1.9.9.599.1.3.1.1.16 |
| cldcClientCurrentTxRateSet | 1.3.6.1.4.1.9.9.599.1.3.1.1.17 |
| cldcClientDataRateSet | 1.3.6.1.4.1.9.9.599.1.3.1.1.18 |

CISCO-AUTH-FRAMEWORK-MIB

| Object | OID |
|----------------------------|-------------------------------|
| cafPortConfigEntry | 1.3.6.1.4.1.9.9.656.1.2.1.1 |
| cafSessionClientMacAddress | 1.3.6.1.4.1.9.9.656.1.4.1.1.2 |
| cafSessionStatus | 1.3.6.1.4.1.9.9.656.1.4.1.1.5 |

| Object | OID |
|------------------------|--------------------------------|
| cafSessionDomain | 1.3.6.1.4.1.9.9.656.1.4.1.1.6 |
| cafSessionAuthUserName | 1.3.6.1.4.1.9.9.656.1.4.1.1.10 |
| cafSessionAuthorizedBy | 1.3.6.1.4.1.9.9.656.1.4.1.1.12 |
| cafSessionAuthVlan | 1.3.6.1.4.1.9.9.656.1.4.1.1.14 |

EEE8021-PAE-MIB: RFC IEEE 802.1X

| Object | OID |
|------------------------------------|------------------------|
| dot1xAuthAuthControlledPortStatus | 1.0.8802.1.1.1.2.1.1.5 |
| dot1xAuthAuthControlledPortControl | 1.0.8802.1.1.1.2.1.1.6 |
| dot1xAuthSessionUserName | 1.0.8802.1.1.1.2.4.1.9 |

HOST-RESOURCES-MIB

| Object | OID |
|----------------|------------------------|
| hrDeviceDescr | 1.3.6.1.2.1.25.3.2.1.3 |
| hrDeviceStatus | 1.3.6.1.2.1.25.3.2.1.5 |

LLDP-MIB

| Object | OID |
|----------------------|--------------------------|
| lldpEntry | 1.0.8802.1.1.2.1.4.1.1 |
| lldpTimeMark | 1.0.8802.1.1.2.1.4.1.1.1 |
| lldpLocalPortNum | 1.0.8802.1.1.2.1.4.1.1.2 |
| lldpIndex | 1.0.8802.1.1.2.1.4.1.1.3 |
| lldpChassisIdSubtype | 1.0.8802.1.1.2.1.4.1.1.4 |
| lldpChassisId | 1.0.8802.1.1.2.1.4.1.1.5 |
| lldpPortIdSubtype | 1.0.8802.1.1.2.1.4.1.1.6 |
| lldpPortId | 1.0.8802.1.1.2.1.4.1.1.7 |

| Object | OID |
|------------------------------|---------------------------|
| lldpPortDescription | 1.0.8802.1.1.2.1.4.1.1.8 |
| lldpSystemName | 1.0.8802.1.1.2.1.4.1.1.9 |
| lldpSystemDescription | 1.0.8802.1.1.2.1.4.1.1.10 |
| lldpCapabilitiesMapSupported | 1.0.8802.1.1.2.1.4.1.1.11 |
| lldpCacheCapabilities | 1.0.8802.1.1.2.1.4.1.1.12 |