

CE 9.4 Cisco TelePresence User Guide SX10 & SX20

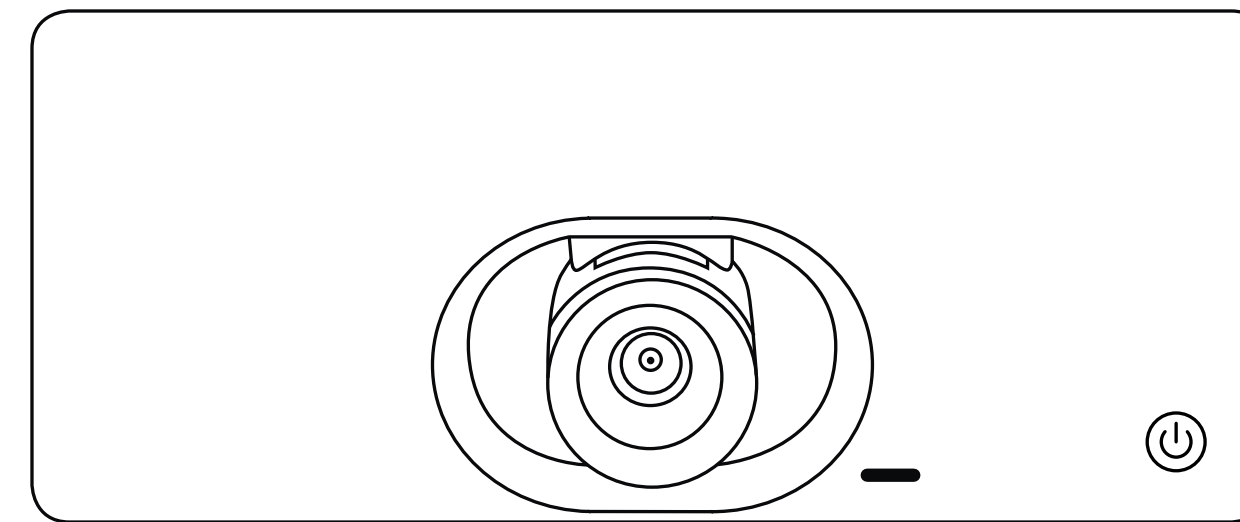

Contents

What's in this guide

Introduction to Video Conferencing	
Tour the Screen	4
Operating tips	4
Tour the Remote Control	5
Operating tips	5
Video Calls	
Place Call From the List of Contacts	8
About List of Contacts	8
Edit a Contacts Before the Call	9
About Editing	9
Edit the Call Rate, then Place the Call	10
About Call Rate	10
Place Call Using Name, Number or IP-Address	11
About Placing Calls	11
Add Additional Participants to Existing Call	12
About Video Conferences	12
Disconnect a Participant From a Conference	13
About Video Conferences	13
Receive Calls	14
If Someone Calls You	14
Receive Additional Calls While Already In a Call	15
Expanding the Call	15
Transfer an Ongoing Call	16
Change the Layout of the Screen	17
About Layout	17
Enable Do Not Disturb	18
About Do Not Disturb	18
Enable Standby	19
About Standby	19
Forward All Calls	20
About Forwarding	20
Intelligent Proximity	
Intelligent Proximity	22
About Proximity	22
Content Sharing	
Start and Stop Presentation	24
About Content Sharing	24
Change Presentation Layout In a Call	25
About Presentation Layout	25
Scheduled Meetings	
Join a Scheduled Meeting	27
Joining a Meeting	27
Contacts	
Add Someone to Favorites, Outside a Call	29
About Directory, Recents and Favorites	29
Add Someone to Favorites, While in a Call	30
About Favorites	30
Camera Control	
View Camera Settings (Local camera)	32
About Camera Settings	32
Far end Camera Control	33
About Far End Camera Control	33
Move the Selfview PiP	34
Why Move the Selfview?	34
Settings	
Gain Access to the Settings	36
About Settings	36

All entries in the table of contents are active hyperlinks that will take you to the corresponding article.

To go between chapters, you may also click on the icons in the sidebar.

Note! Some of the features described in this user guide are optional and they may therefore not apply to your system.

Introduction to Video Conferencing

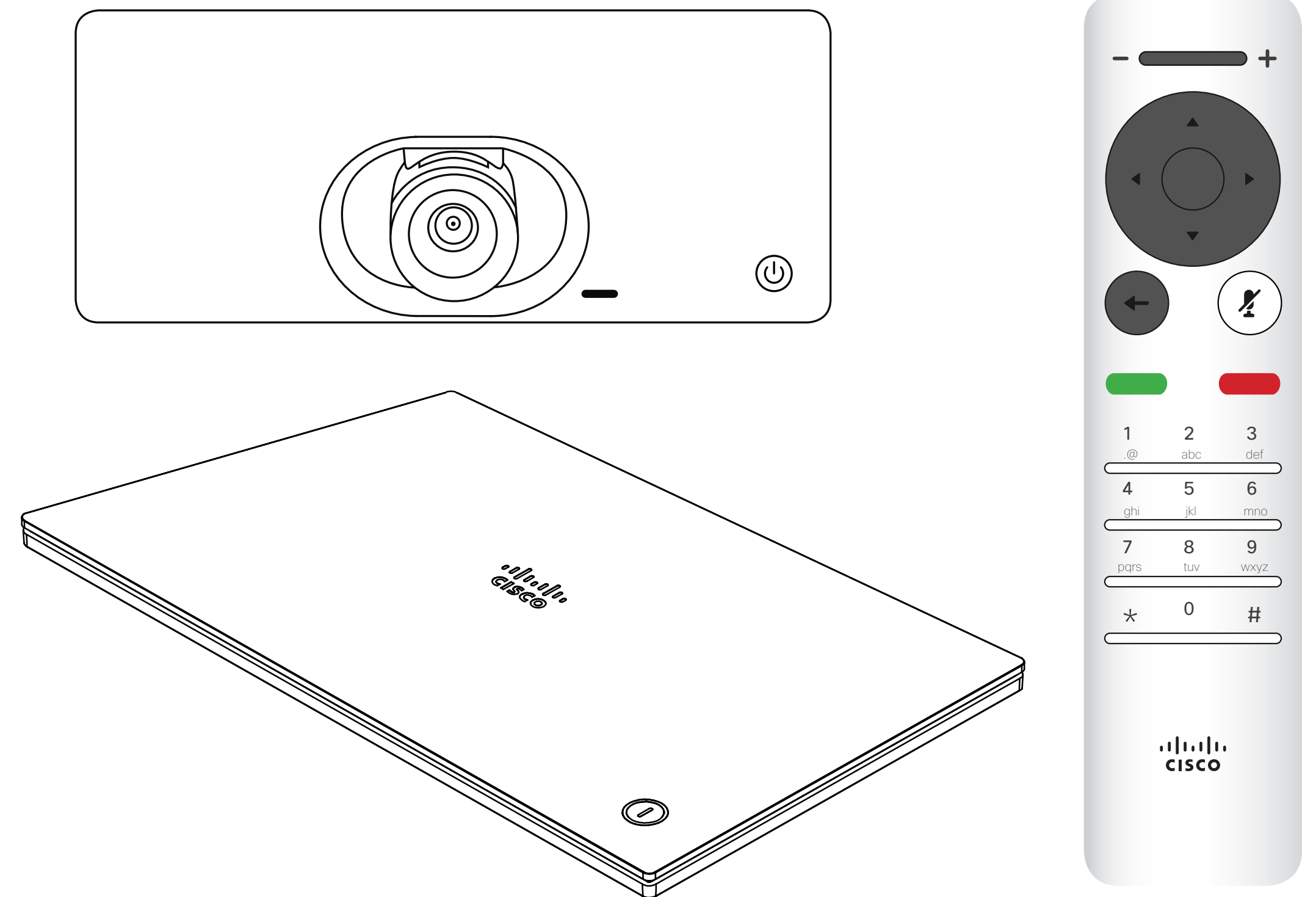

Tour the Screen

Operating tips

Upper left corner of the screen contains the *More* icon (➤) which provides access to *Standby mode*, *System information* and the *Do Not Disturb* feature.

The **Camera Control menu** icon is located in the upper right corner of the display.

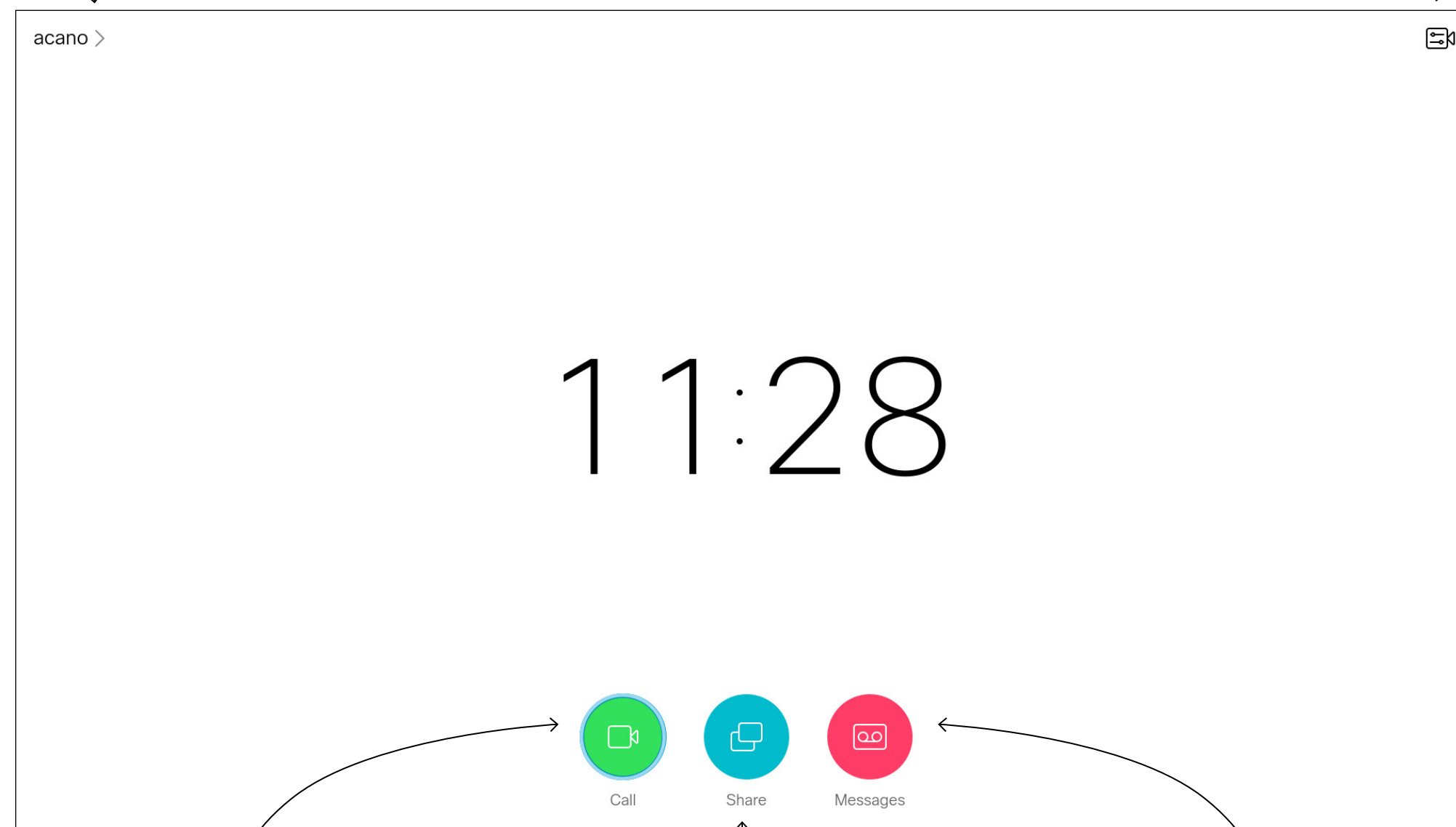

The *Call* button located to the left in the lower part of the display.

The *Share* button is located to the right in the lower part of the display.

If a messaging system exists for your system, access messages from here.

Use the **Cursor** controls the remote control to move about the screen and press **OK/Enter** to open the selected menu field.

Use the **Cancel** key to exit a menu (and return to the Home screen) undoing any changes. Use the **Back** key to go just one step back.

The remote control buttons are described on the following pages.

The **Intelligent Proximity** feature allows you to share, see and capture content from a video system wirelessly on your own device. You can also use your own device to control calls on the video system. See also [“Intelligent Proximity” on page 21](#).

Tip When set to Do Not Disturb, ringtones are muted and call attempts made by others to reach you will appear as missed calls. You may, however, place calls as much as you like.

As default, there is a 60 minutes timeout on the Do not disturb (after which the system will return to normal operation), but this may have been changed to a different setting by your Video Support Team.

Tour the Remote Control (I)

Operating tips

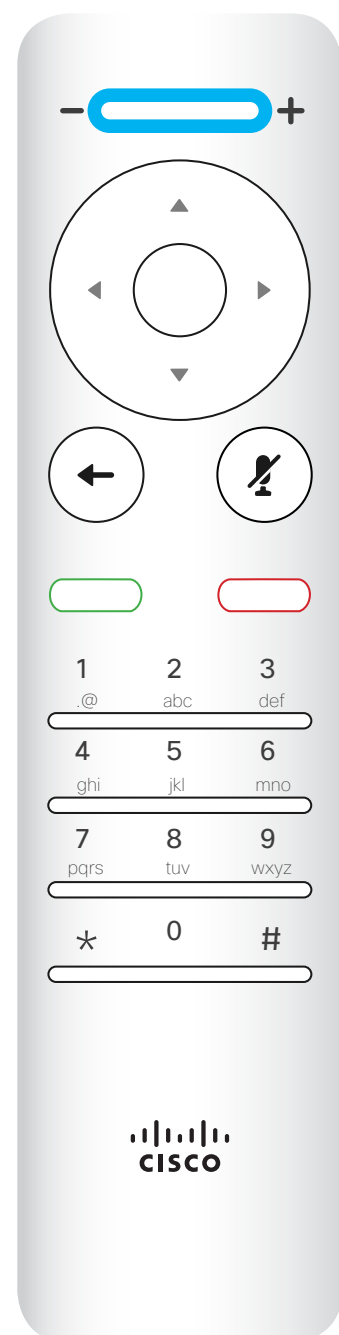

Left part of the uppermost button controls
Lower volume /Decrease.
Right part of the uppermost button controls
Higher volume /Increase.

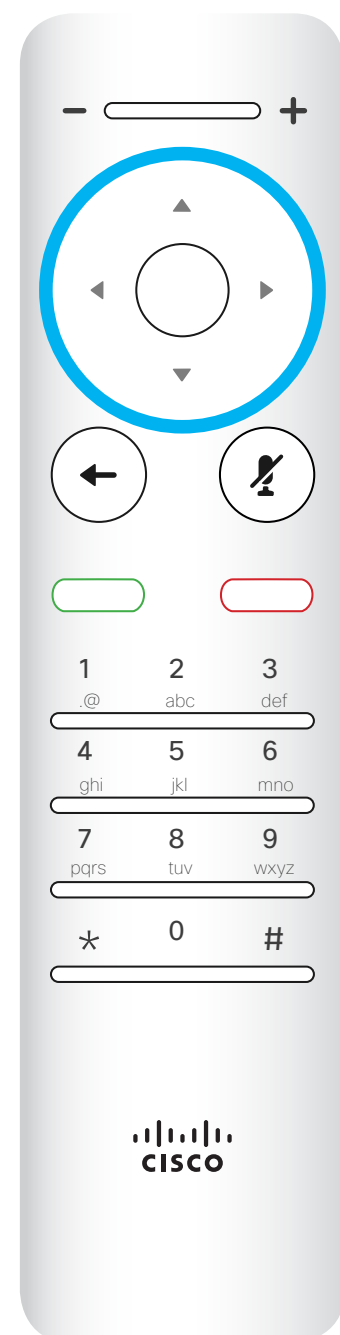

To operate **Field selector/Cursor** keys use the perimeter keys of the circular field (**Left/Right/Up/Down**).

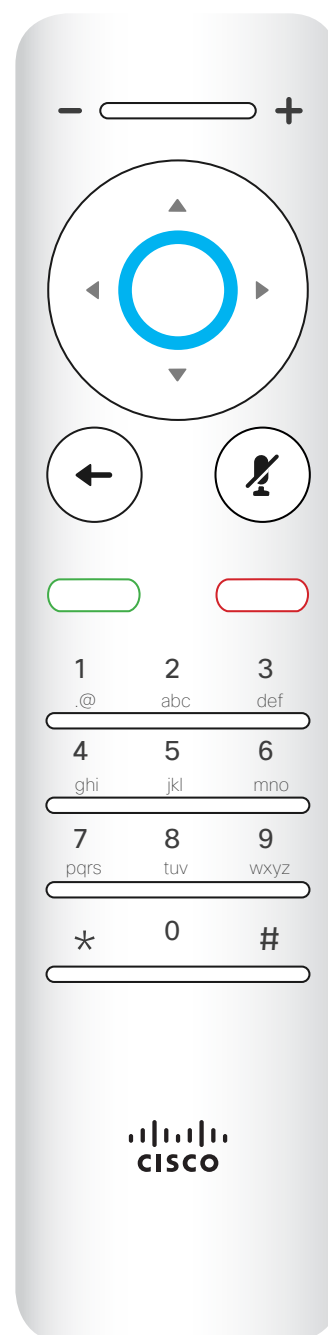

OK/Enter is done by means of the center circular key.

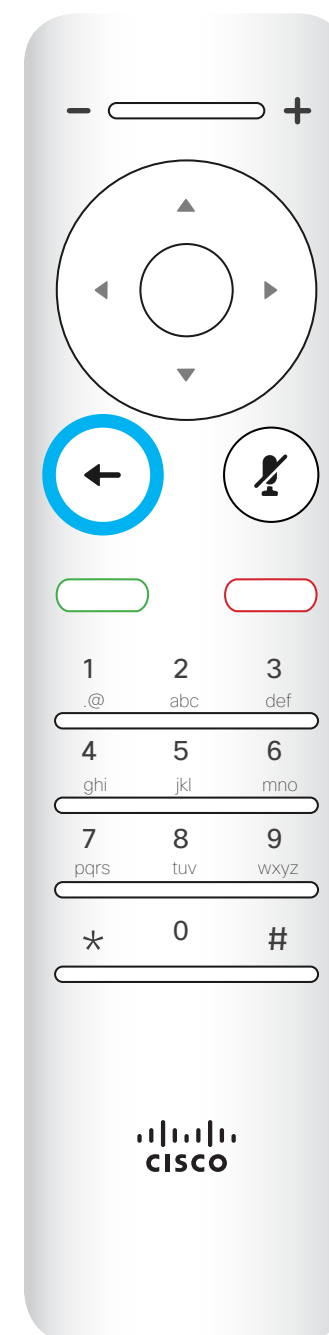

Go back one step is done by means of the left circular key

Use the **Cursor** controls to move about the screen and press **OK/Enter** to open the selected menu field.

Use the **Cancel** key to exit a menu (and return to the *Home* screen) undoing any changes. Use the **Back** key to go just one step back.

Tour the Remote Control (II)

Operating tips

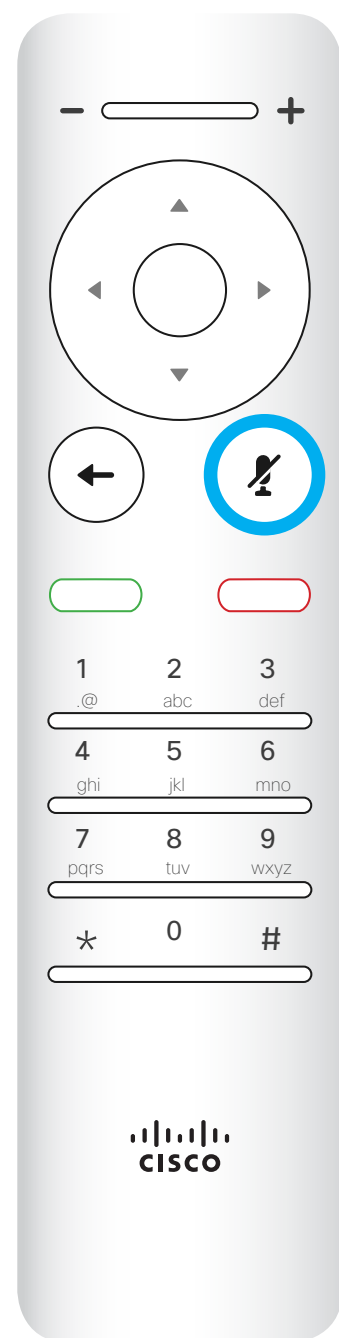

Microphone mute/unmute is the right circular key.

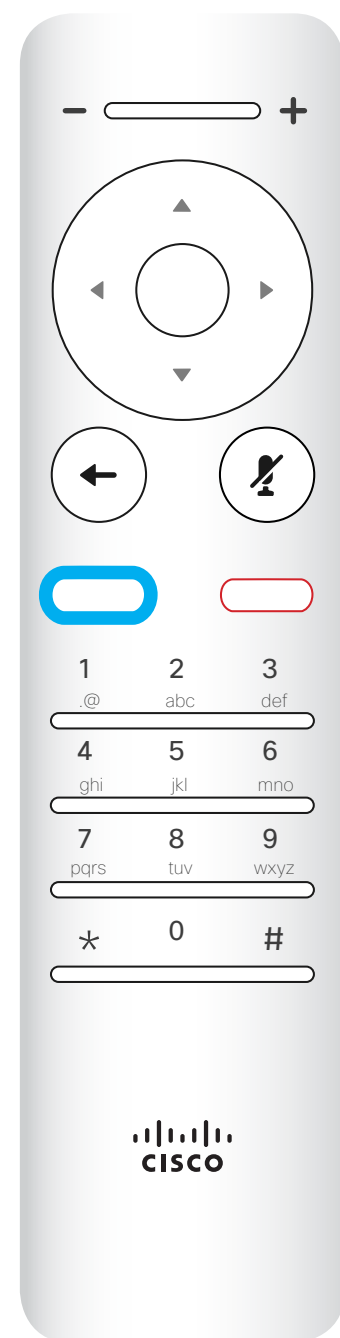

The key below the **Go back** is the green **Call button / Accept incoming call**.

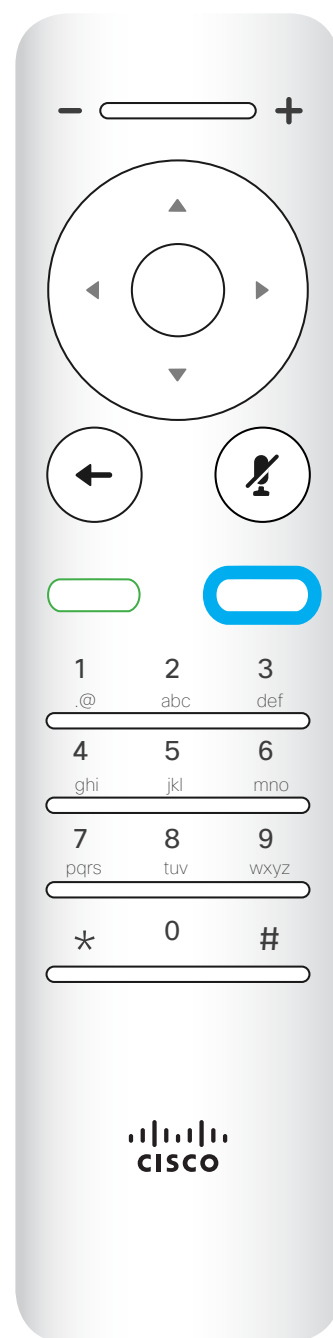

The key below the Mute key is the **Reject incoming call / End call / Cancel / Back to Home screen** (outside calls).

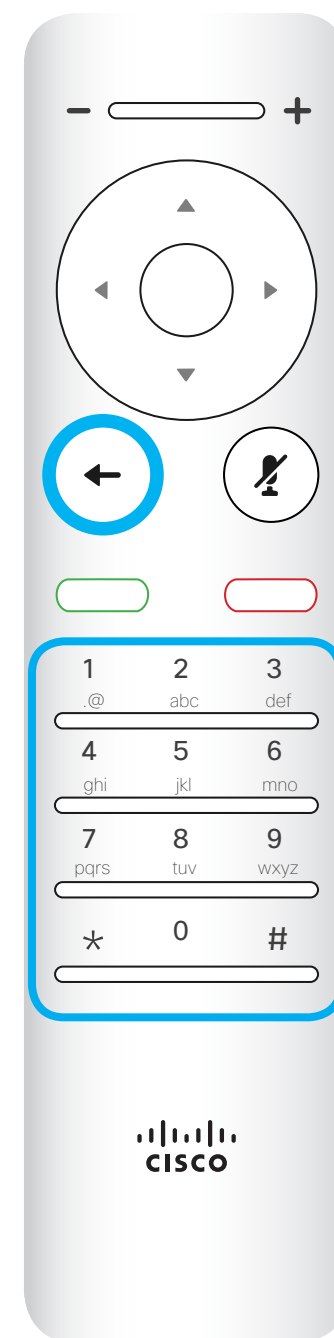

The **Keypad** is used to dial someone or input numerals. There is a raised bump on digit 5 to identify the keys.

Use the **Cursor** controls to move about the screen and press **OK/Enter** to open the selected menu field.

Use the **Cancel** key to exit a menu (and return to the *Home* screen) undoing any changes. Use the **Back** key to go just one step back.

Video Calls



Place Call From the List of Contacts

About List of Contacts

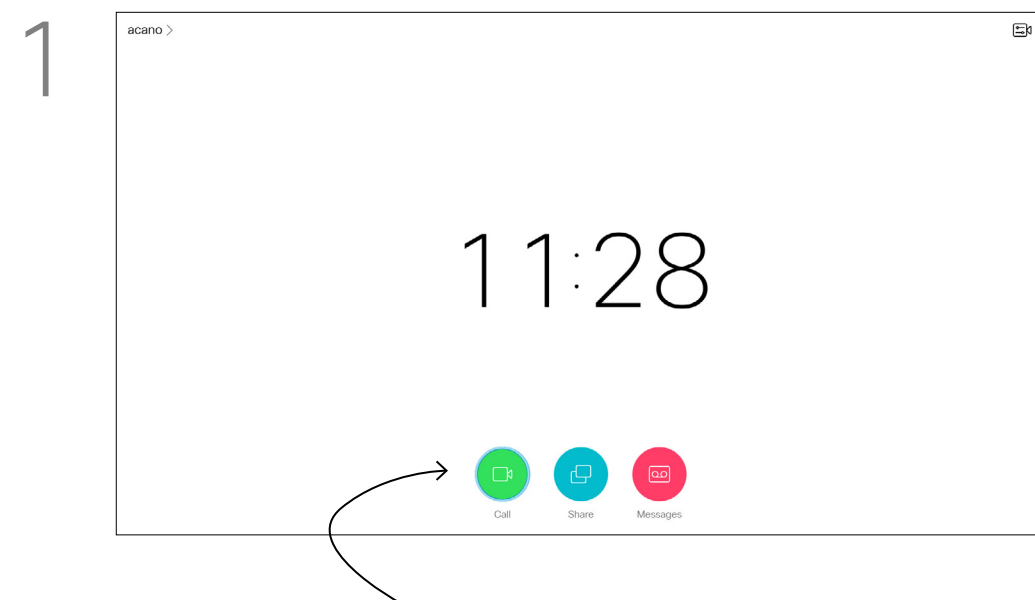

1 Make sure **Call** is selected (the leftmost icon along the bottom of the screen) and press **OK** on the remote control or press the green **Call** button on the remote control.

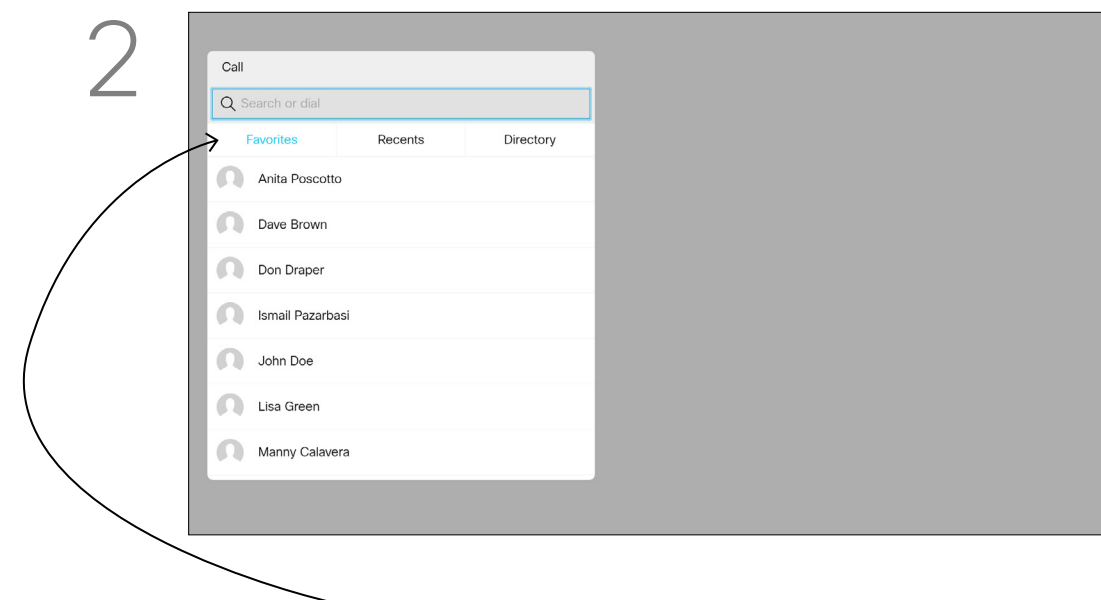

2 The Contact list appears. Use the **Cursor** keys on the remote control to navigate between *Favorites*, *Recents* and *Directory* (horizontally) and then down in one of the lists.



3 Once an entry has been located, press **OK** on the remote control to invoke the *Call* menu.

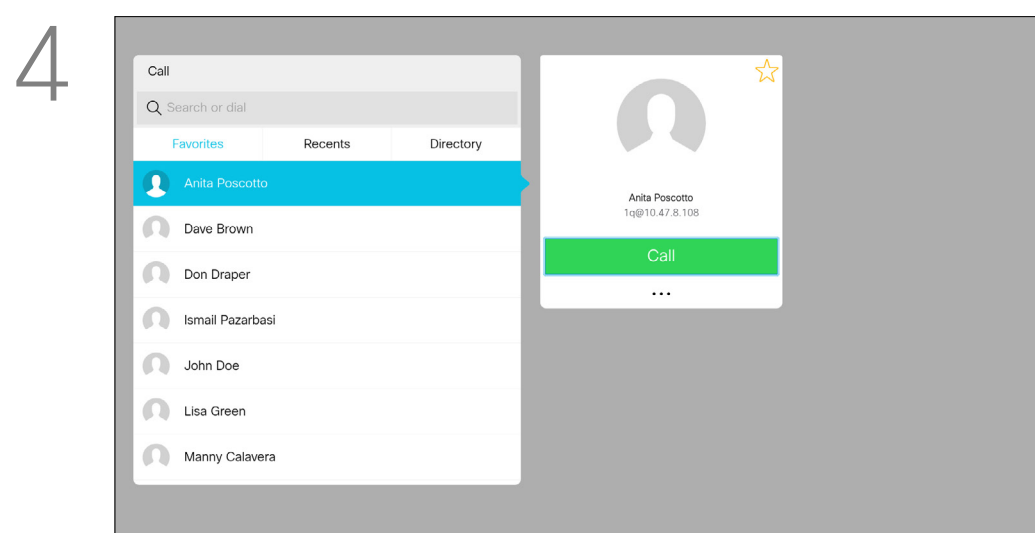

4 In the Call menu, press **OK** or the green **Call** button on the remote control to place the call.

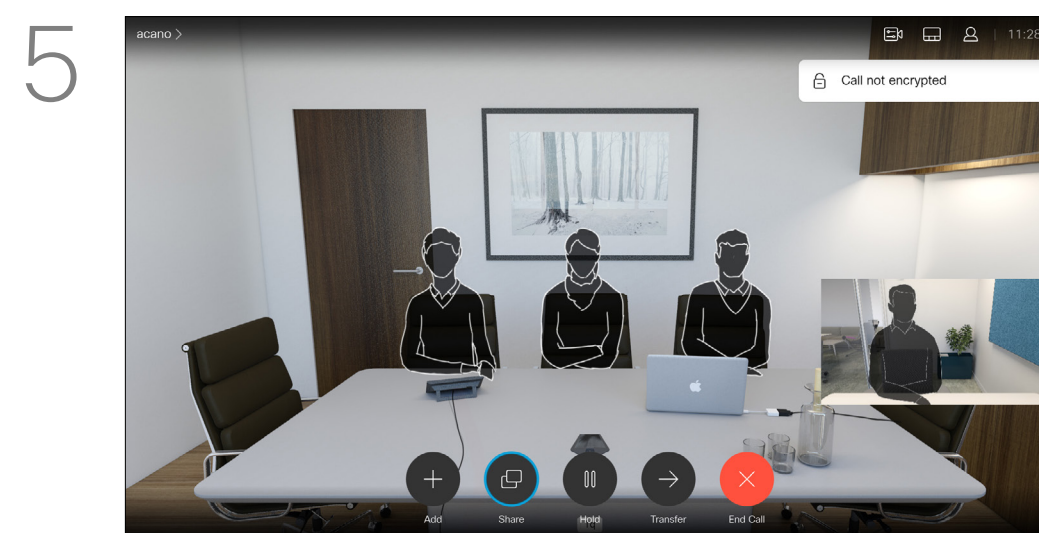

5 Press the red **End Call** button on the remote control, or use the **Cursor** keys to select *End Call* on the screen and then press **OK** to terminate the call.

Your list of Contacts consists of three parts:

Favorites. These contacts have been put there by you. These entries will typically be someone you call frequently or otherwise need to access in a swift and convenient manner from time to time. A favorite is denoted by a golden asterisk

Directory will typically be a corporate directory installed on your system by your video support team.

Recents is a list of calls you have placed, received or missed earlier.

The following options apply:

- You may key in a name, number or an IP address and the system will look in all lists for you.
- You may tap a tab and then scroll through the list or key in a name or number. Your search will then be restricted to that specific list.
- You may add the entry to the list of Favorites; edit aspects of the entry before calling and/or change the call rate (the bandwidth applied to the call).

Edit a Contacts Before the Call

About Editing

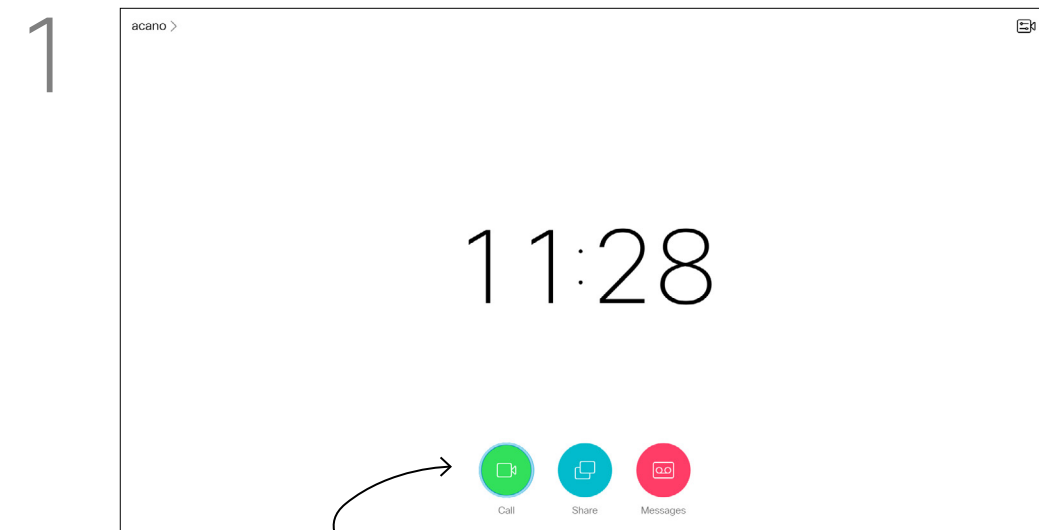

1 Make sure *Call* is selected (the leftmost icon along the bottom of the screen) and press **OK** on the remote control or press the green **Call** button on the remote control.

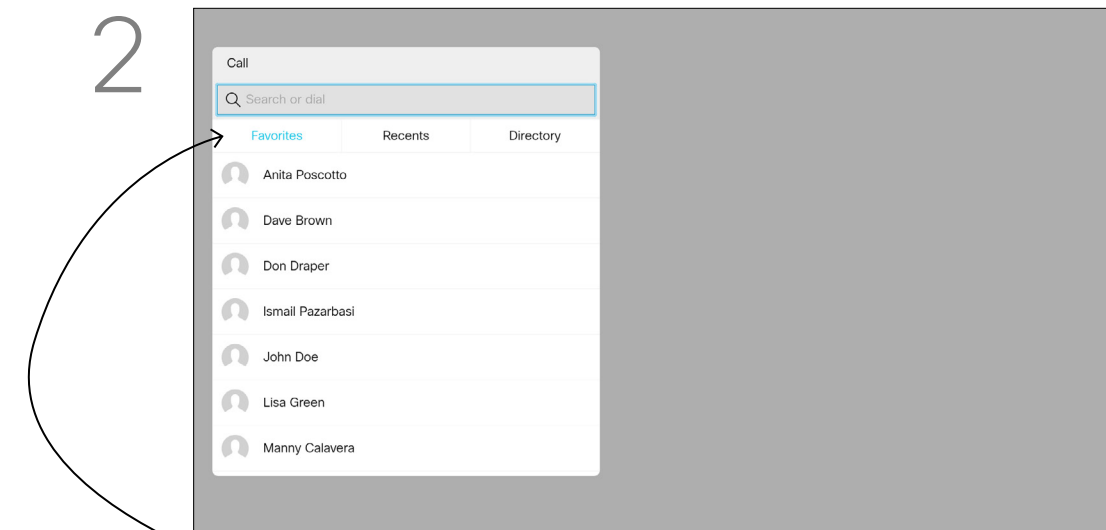

2 Use the **Cursor** keys on the remote control to navigate between *Favorites*, *Recents* and *Directory* and then down in one of the lists.

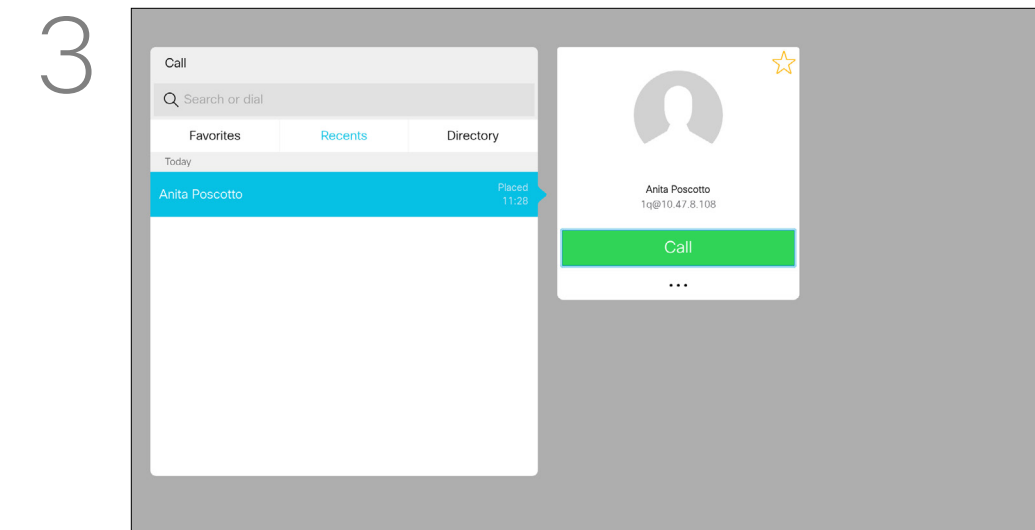

3 Once an entry has been located, press **OK** on the remote control to invoke the *Call* menu.

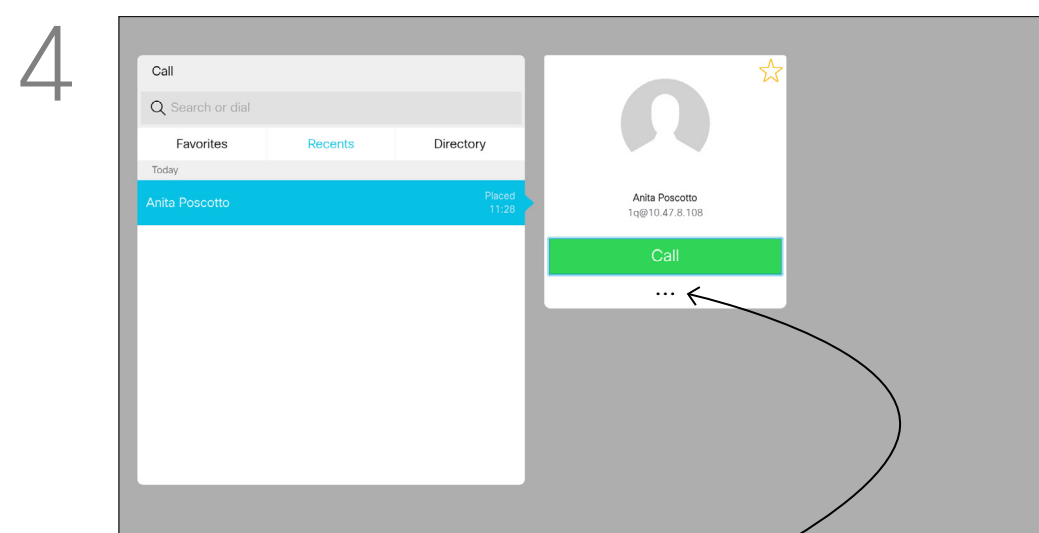

4 Use the **Cursor** keys on the remote control to navigate to the *More* field (...) and press **OK**.

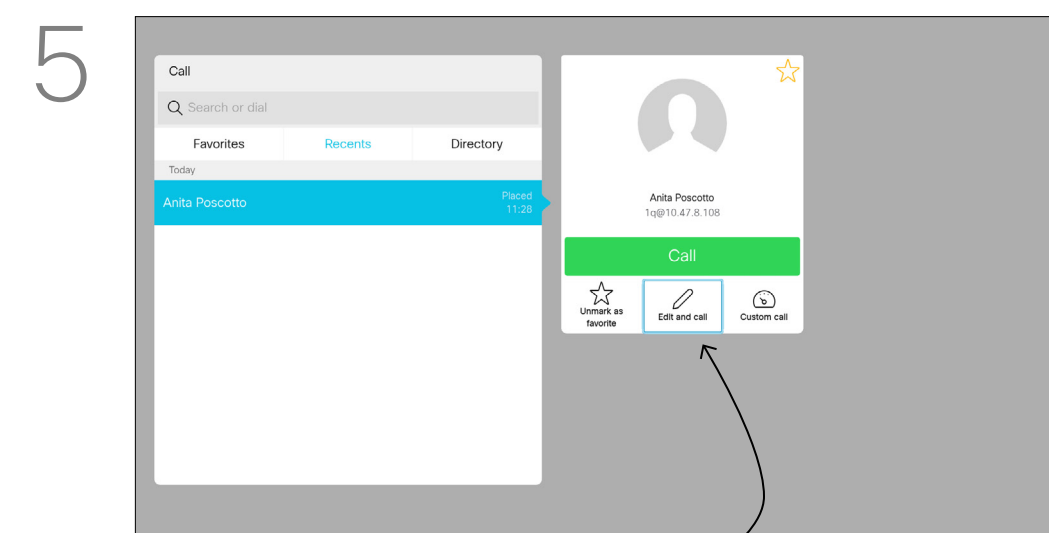

5 Navigate down to *Edit and Call* (center field in the *More* menu) and press **OK**.

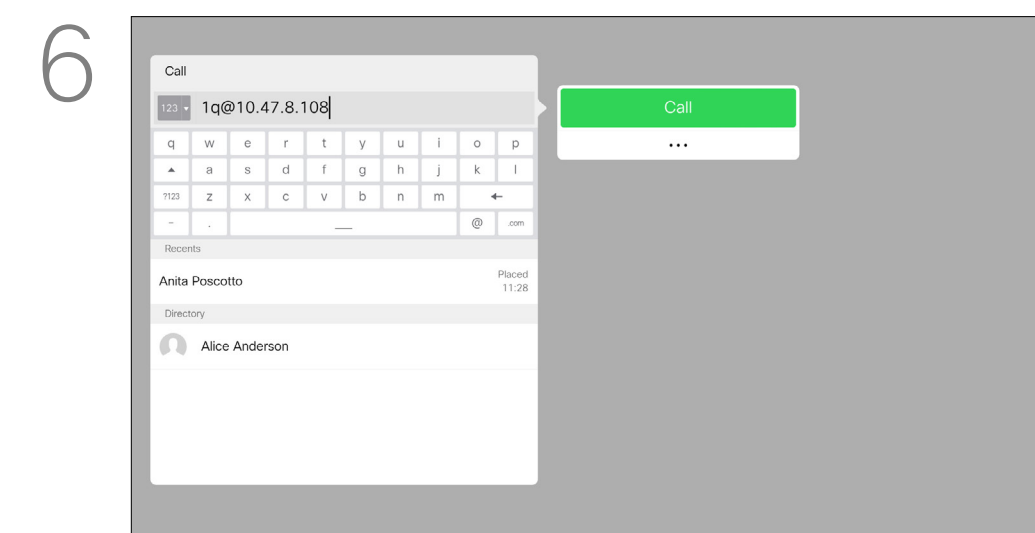

6 Edit the entry as required and press the green **Call** button on the remote control to place the call.

For more on the Contacts list, see the previous page.

You may need to edit an entry in one of the lists of Contacts before you place the call, such as to add a prefix, a suffix or otherwise alter the entry to ensure success.

Edit the Call Rate, then Place the Call

About Call Rate

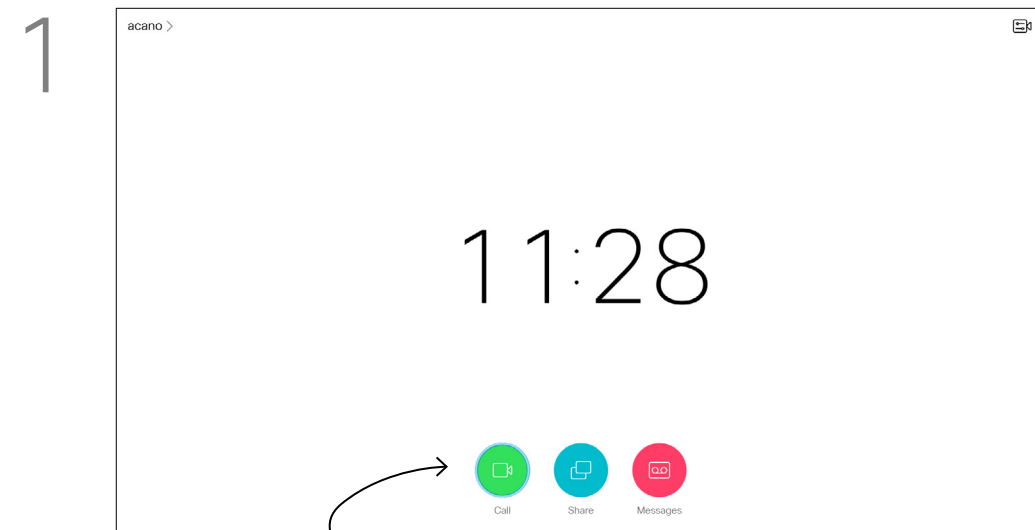

1 Make sure *Call* is selected (the leftmost icon along the bottom of the screen) and press **OK** on the remote control or press the green **Call** button on the remote control.

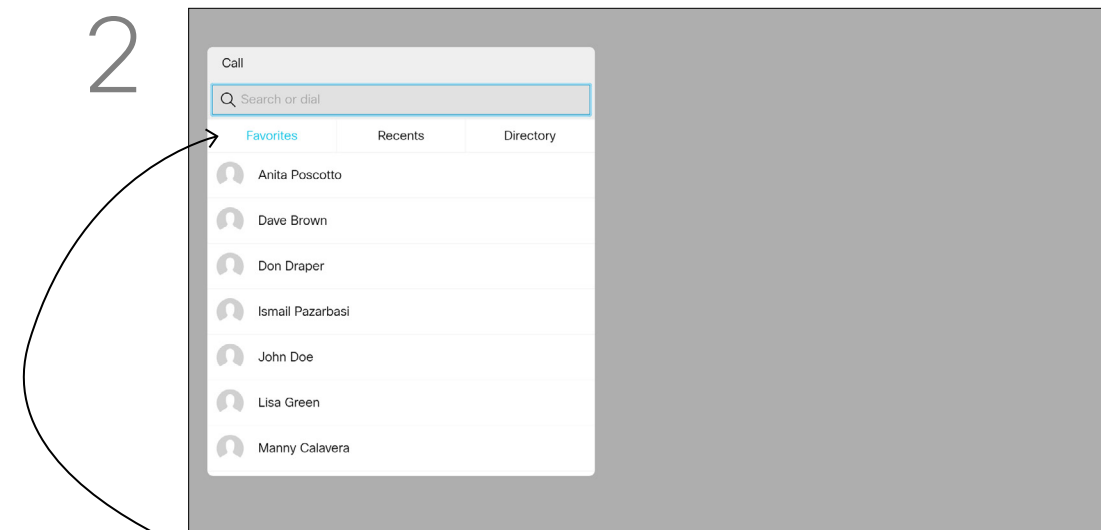

2 Use the **Cursor** keys on the remote control to navigate between *Favorites*, *Recents* and *Directory* and then down in one of the lists.

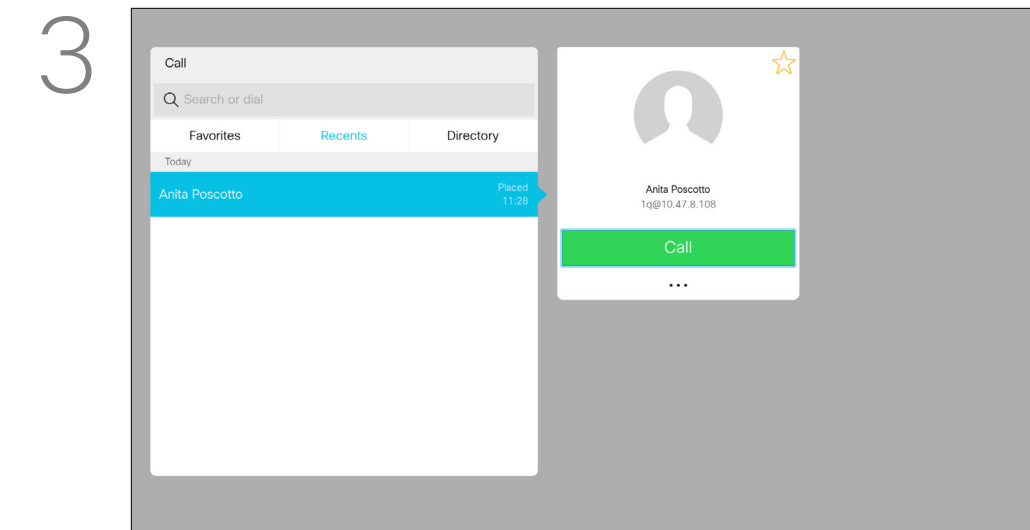

3 Once an entry has been located, press **OK** on the remote control to invoke the *Call* menu.

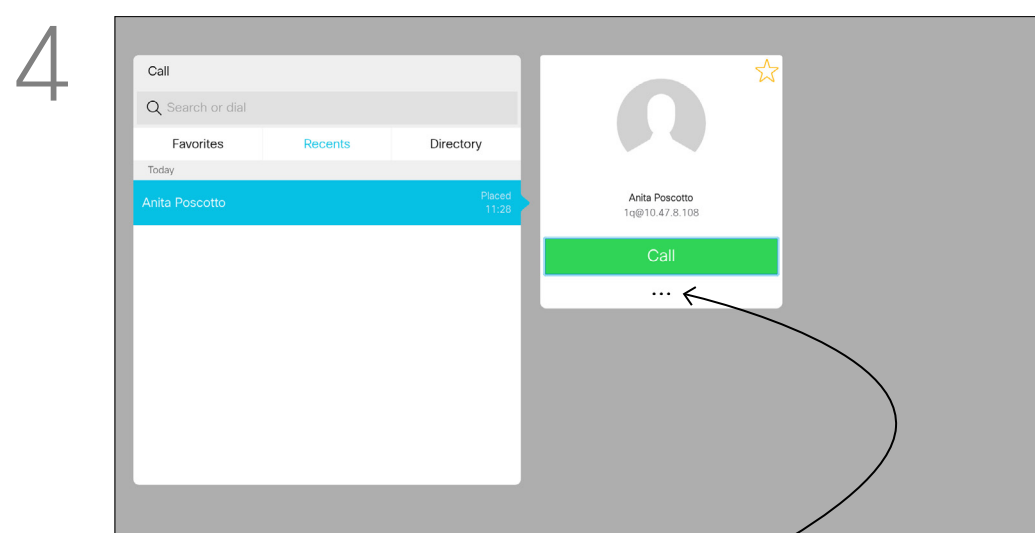

4 Use the **Cursor** keys on the remote control to navigate to the *More* field (...) and press **OK**.

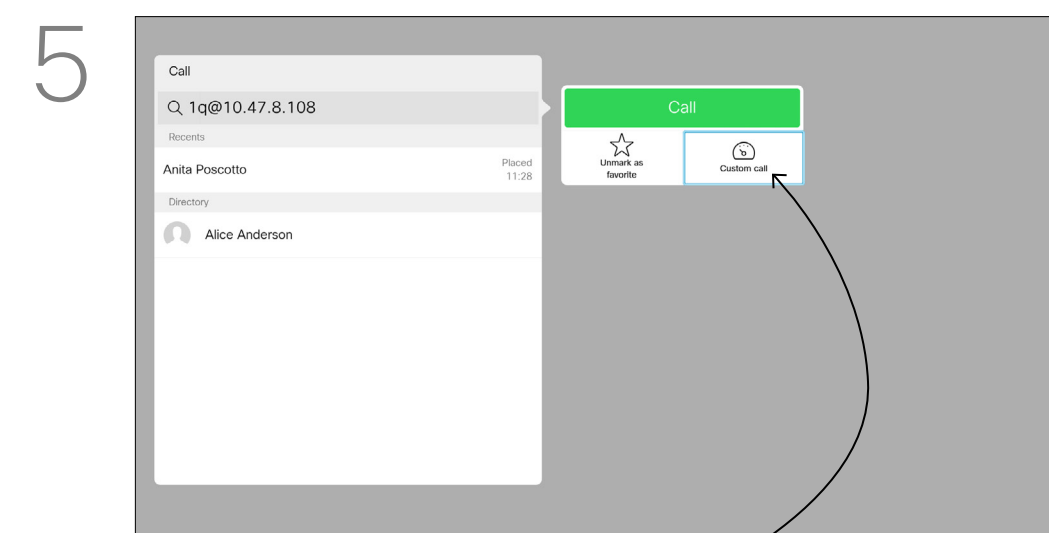

5 Move down to *Custom call* and press **OK**.

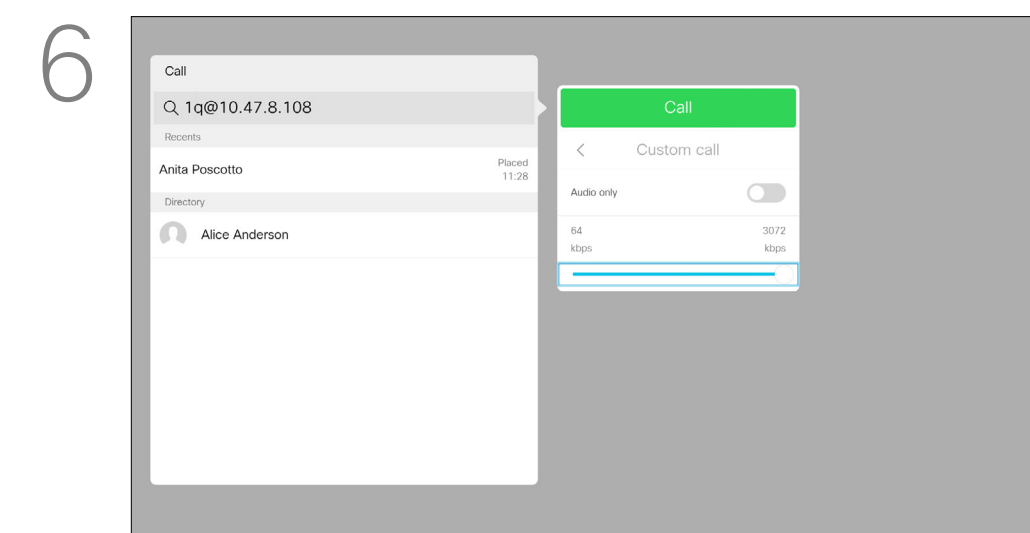

6 Use the **Cursor** keys as required and press the green **Call** button on the remote control to place the call.

Call rate is the term used to express the amount of bandwidth allocated to the call. It is measured in kbps (kilobits per second).

The higher the call rate is, the better the quality will be, but on the expense of higher bandwidth consumption.

The system comes with a default call rate. This is normally set by your video support team. Under normal conditions the call rate will be adjusted automatically by the system, whenever needed. This is done to avoid choking the video call when you try to call someone at a higher rate than their system and connection support.

If, for some reason, the automatic call rate setting fails, you may also do this manually as a last resort.

Call rate cannot be changed during a call, but you may change it just before you place a call, as shown at left.

Place Call Using Name, Number or IP-Address

About Placing Calls

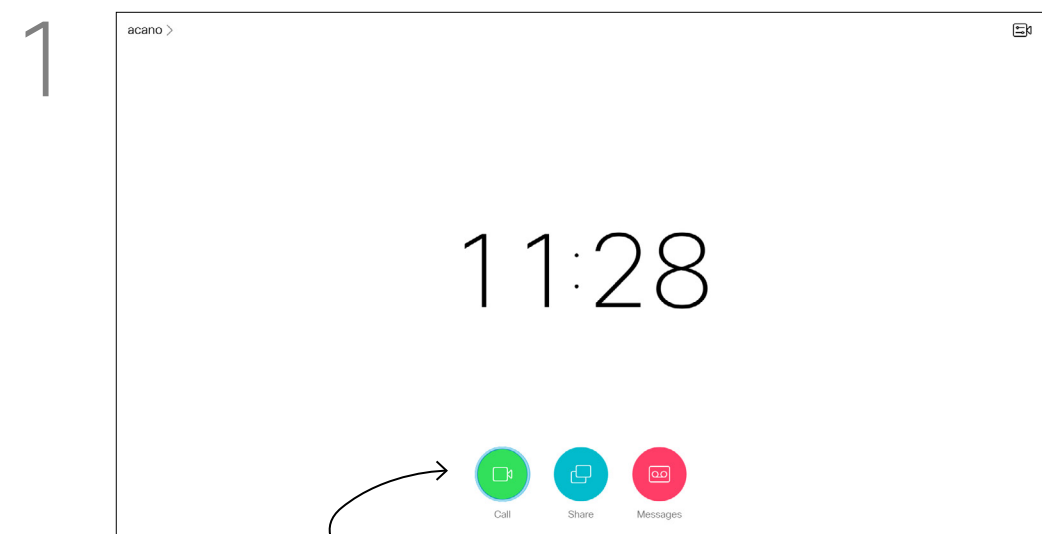

1 Make sure **Call** is selected (the leftmost icon along the bottom of the screen) and press **OK** on the remote control or press the green **Call** button on the remote control.

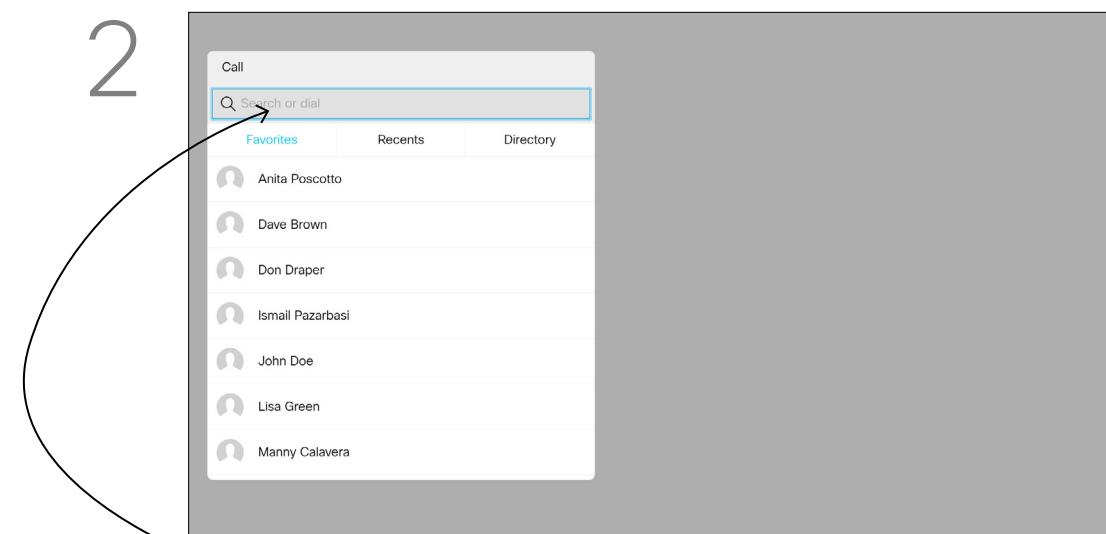

2 Use the **Cursor** keys to navigate to the **Search or Dial** field at the top of the menu. Press **OK**.

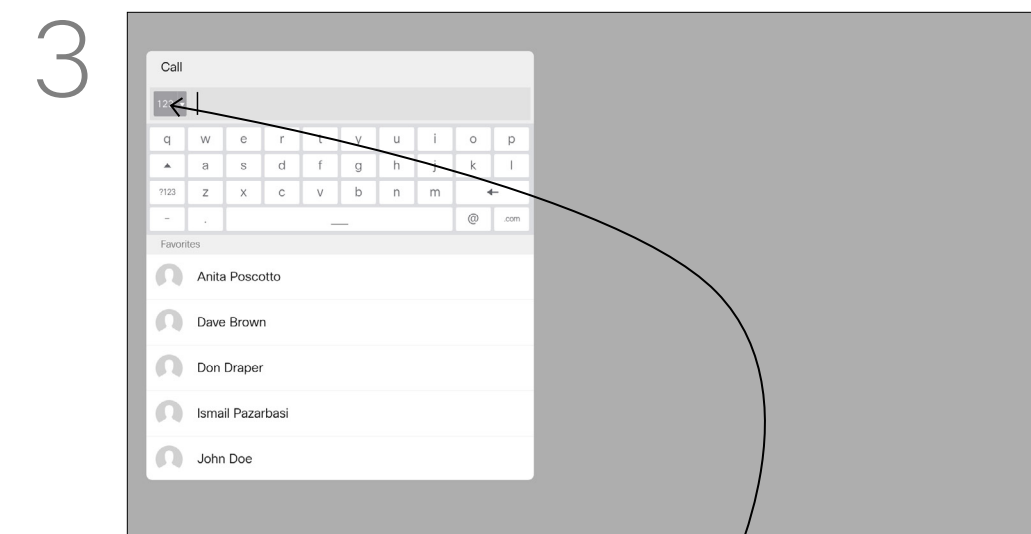

3 To enter numbers select **123**.

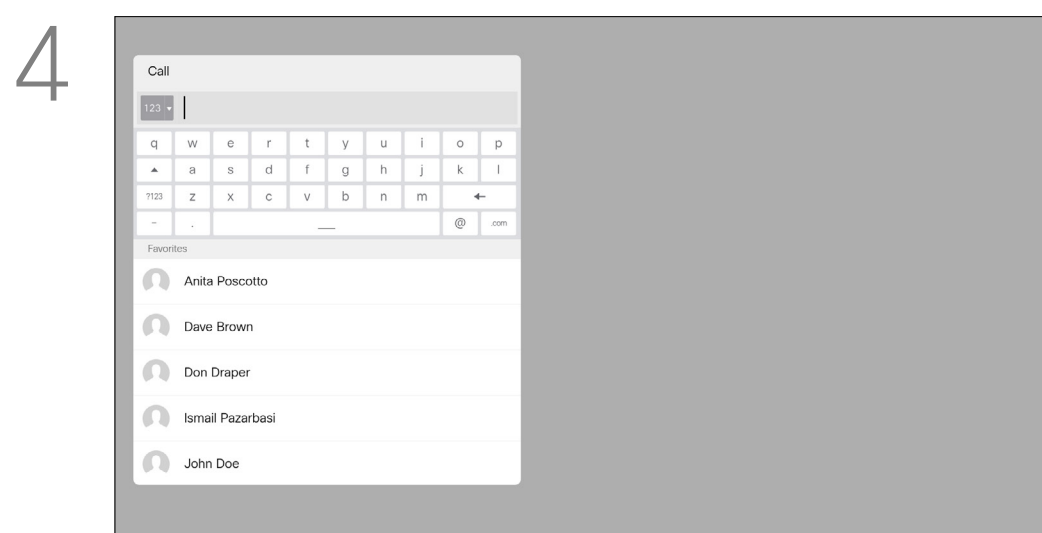

4 To use the virtual keyboard, navigate down to and about the keyboard and select characters. Press **OK** to select a character.

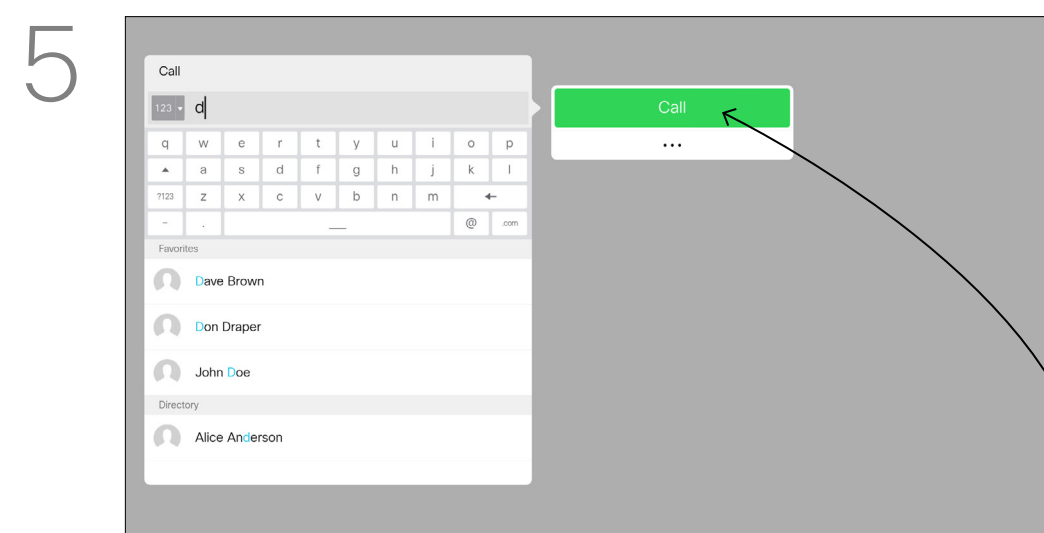

5 Then press the green **Call** button on the remote control to place the call. Alternatively, navigate to the **Call** icon and press **OK**.

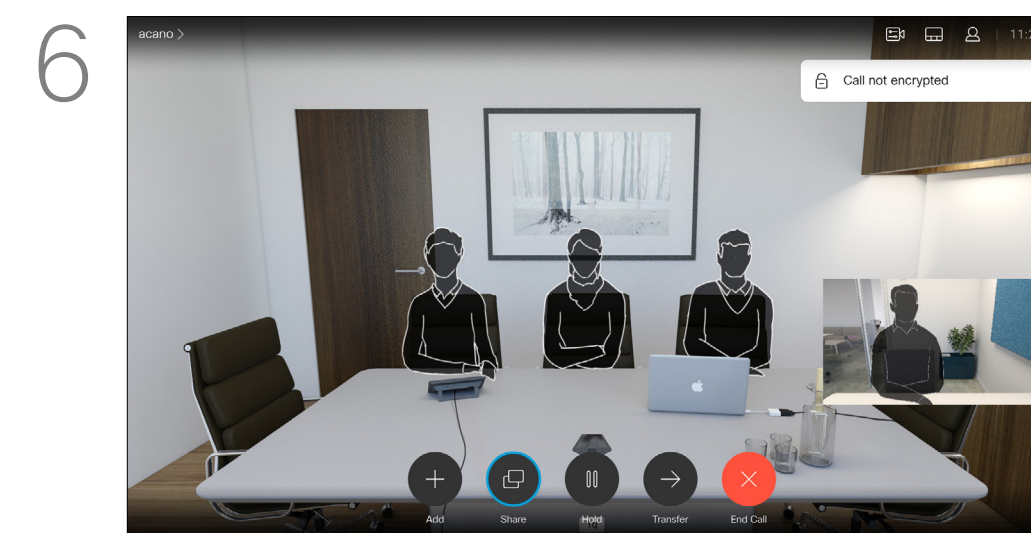

6 Press the red **End Call** button on the remote control, or use the **Cursor** keys to select **End Call** and then press **OK** to terminate the call.

You may call someone who is not listed in your list of contacts by keying in their name, address or number using the virtual keyboard. Anyone you have previously called will appear in the *Recents* list and you may then add any of them to your list of *Favorites*. This is described in the section *Contacts*.

Call Using Video Address

The procedure when using an IP type video address to call someone is similar. Just key in the address and use * (the asterisk button in the lower left corner on the remote control) as separator. The system will interpret this as a valid IP address separator so that the video address appears as correctly entered.

Add Additional Participants to Existing Call

About Video Conferences



1 In a call, navigate to *Add* and press **OK** on the remote control. This will put the current call on hold.

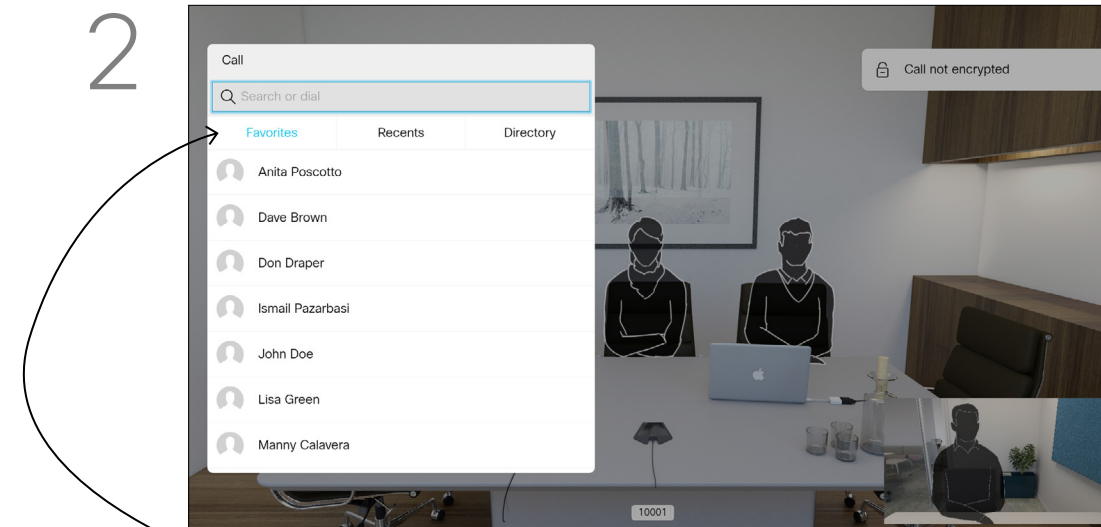

2 Locate the participant to be added in the usual way. Press **OK**.

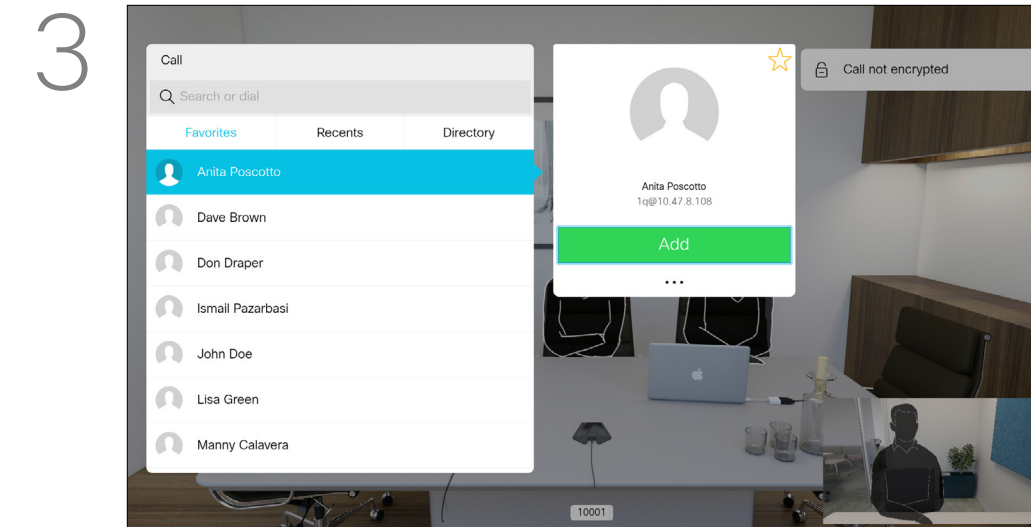

3 Navigate to *Add* and press **OK** to expand the call into a conference.

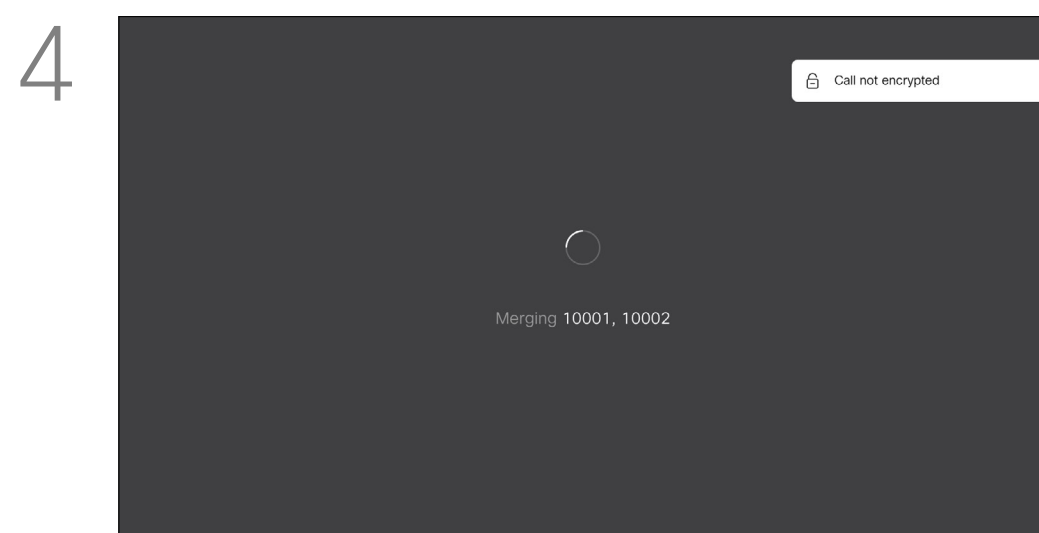

4 The calls will now be merged together.

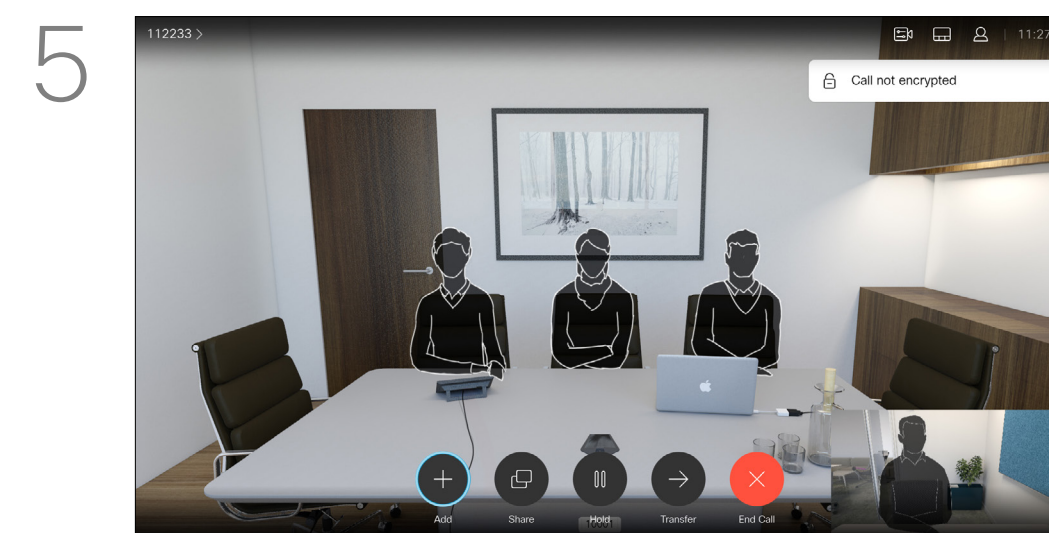

5 Repeat the process to add more participants, if needed.

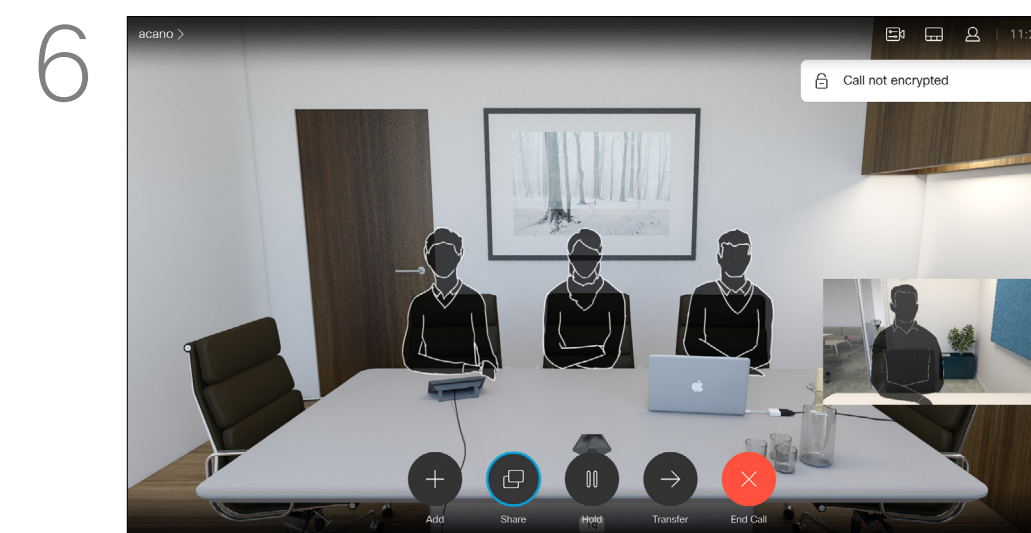

6 Press the red **End Call** button on the remote control, or use the **Cursor** keys to select *End Call* and then press **OK** to terminate the call.

Your video system network may be equipped with the capability to initiate a video conference with several participants.

The maximum number of participants supported by your video system will depend on system configuration and the video infrastructure. If in doubt, contact your video support team.

If you want to initiate a video conference, you must call each participant one by one.

If you are the one who initiated the conference you will be able to terminate the entire conference. The other participants may only disconnect themselves from the conference.

Disconnect a Participant From a Conference

The ability to conduct a video conference from your video system is an optional feature that may, or may not, be available for your system.

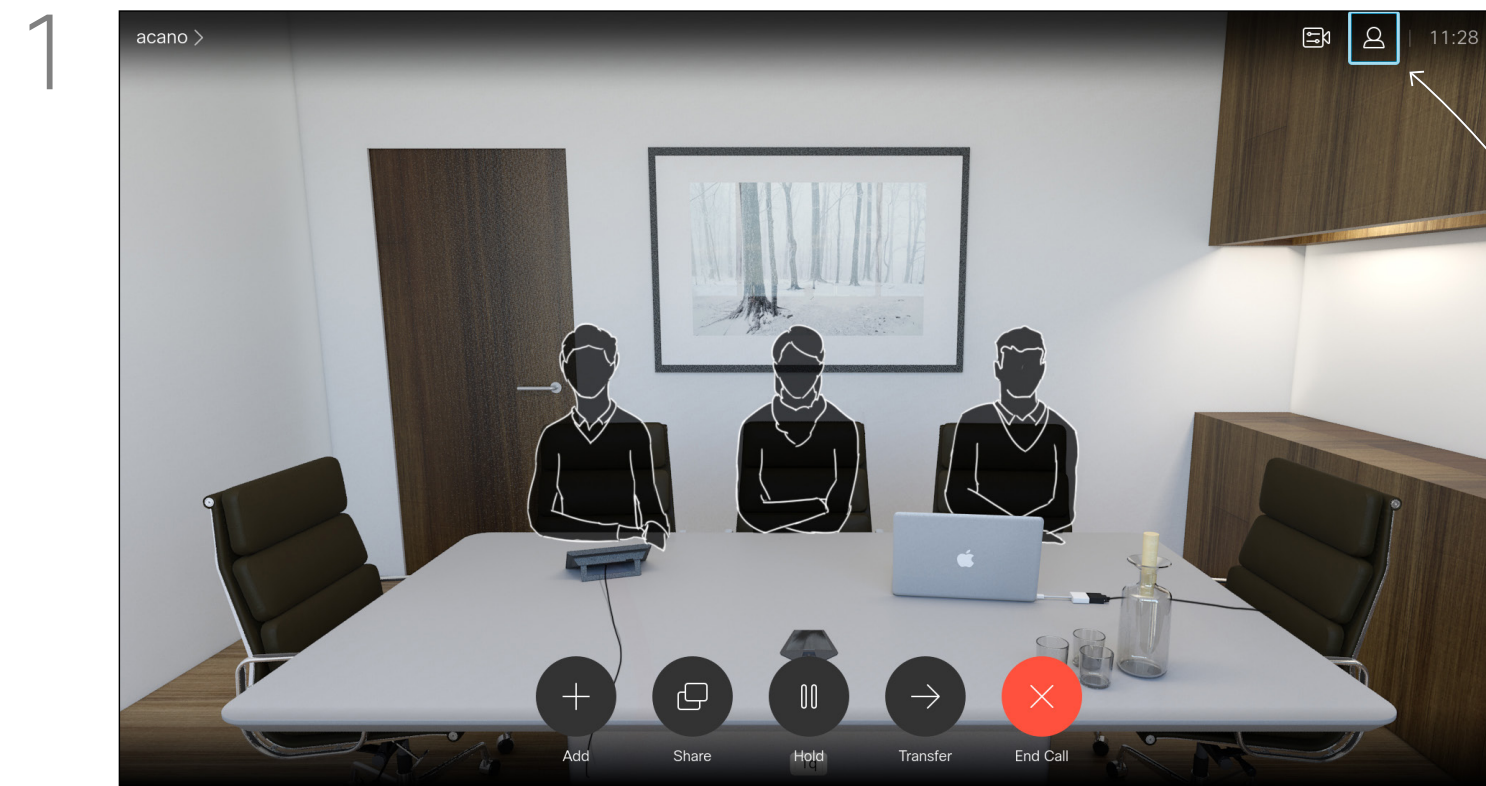

In a call, navigate to the *Participants* icon in the upper right corner, as shown, and press **OK** to invoke the list of participants.

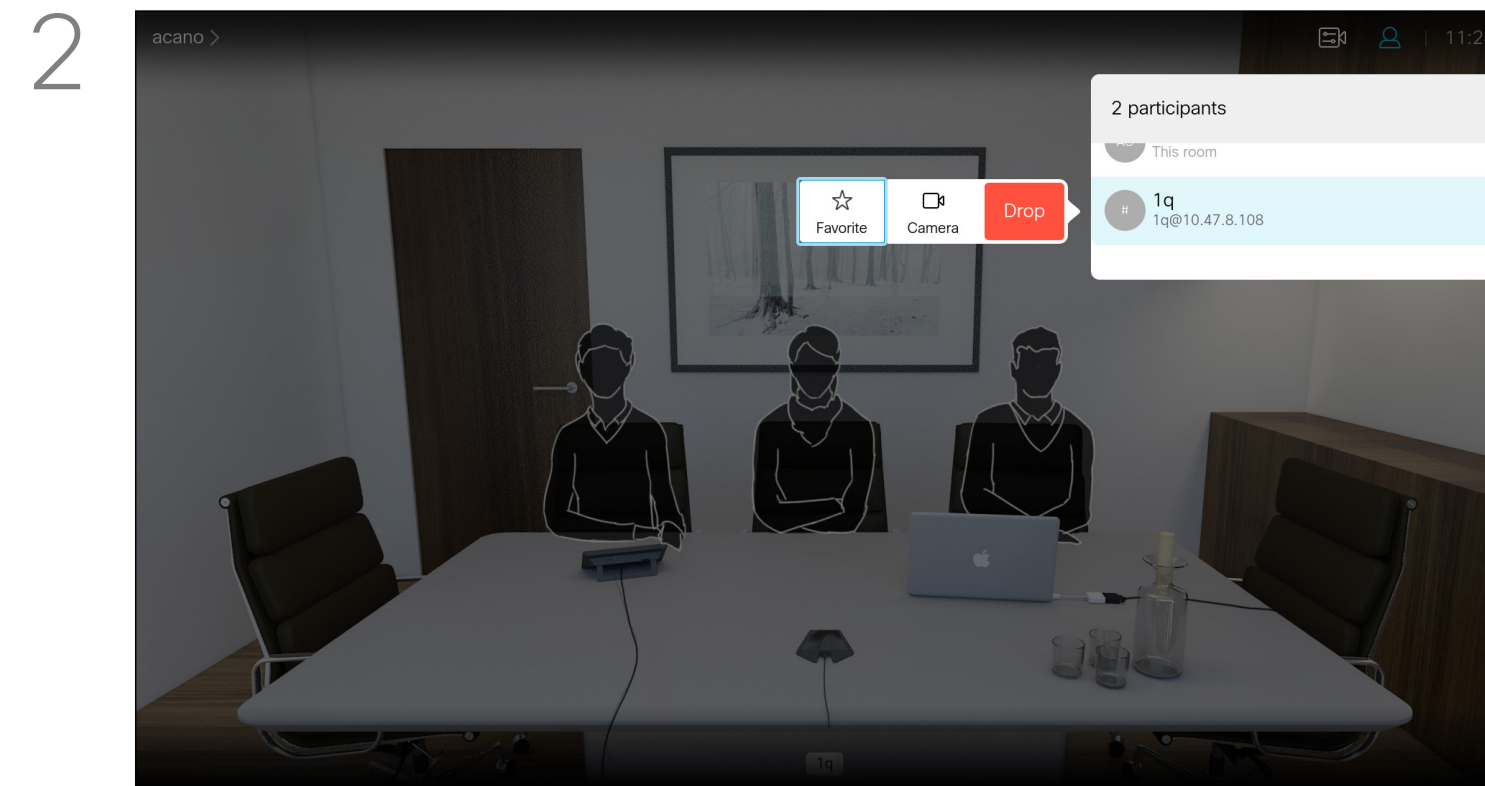

Navigate down to the participant to be dropped from the conference and press **OK**.

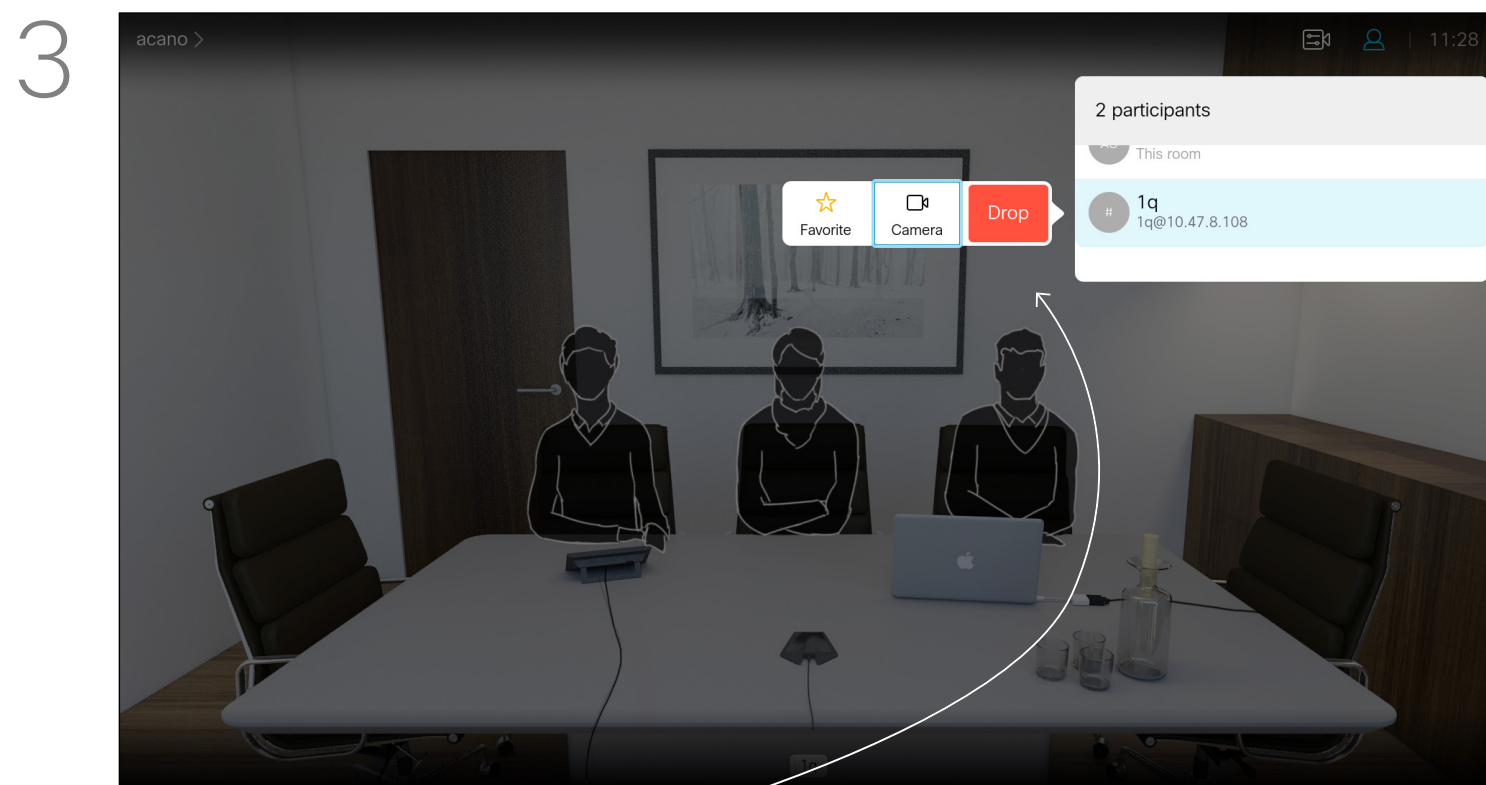

Navigate to *Drop* and press **OK**.

Video Calls

Receive Calls

If Someone Calls You

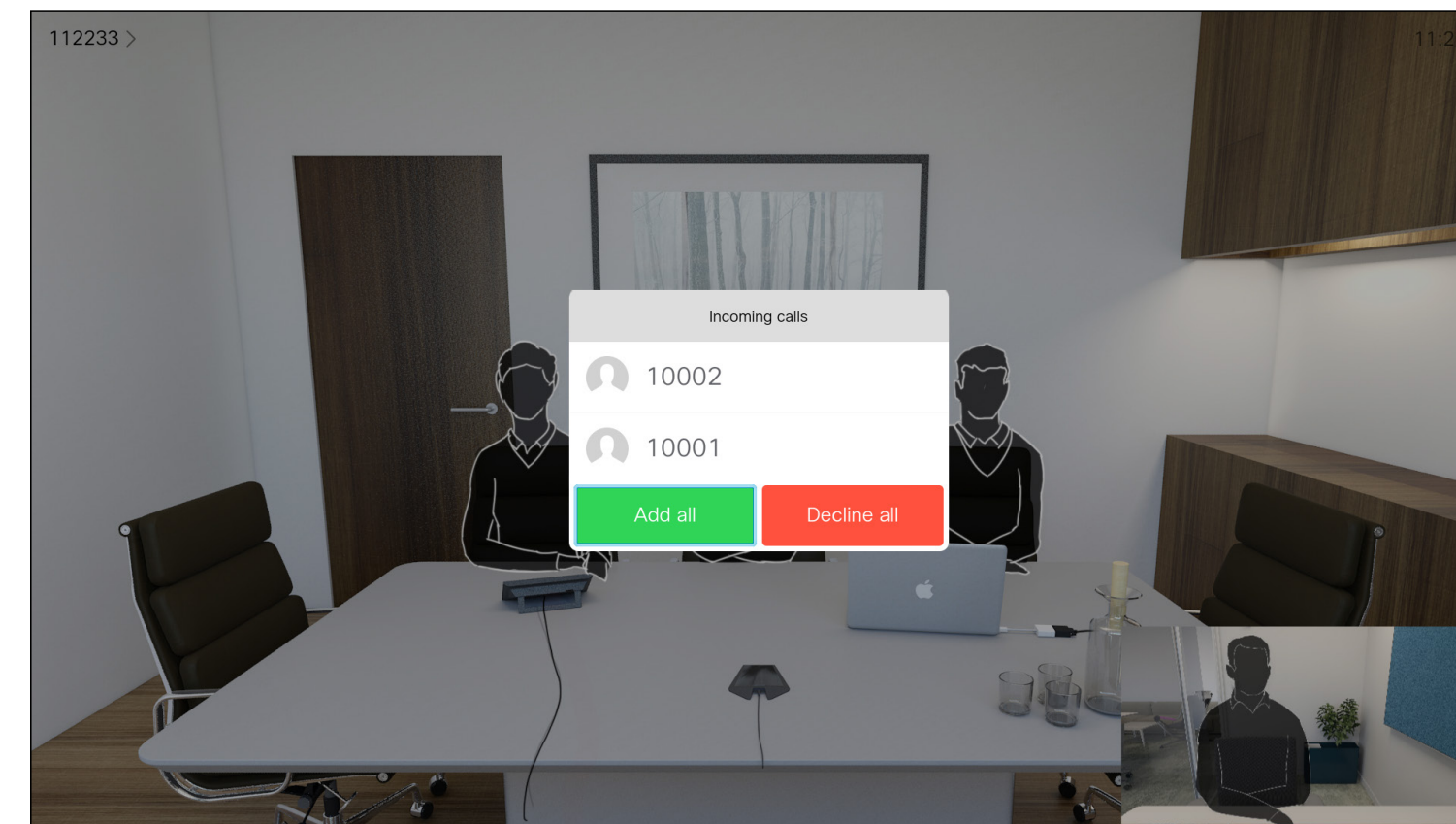
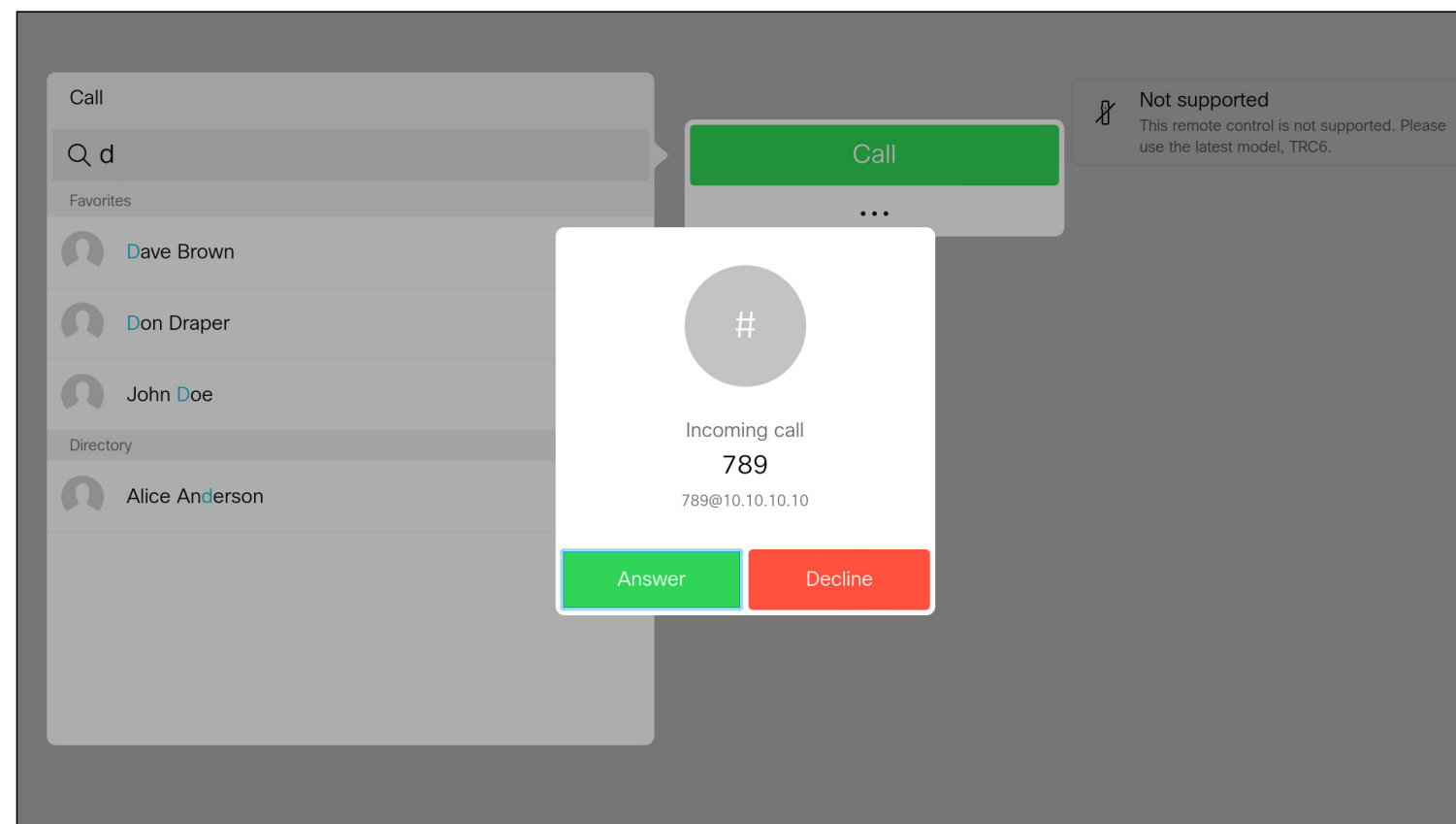

- If someone calls you, you may accept, decline or ignore the call.
- If you decline the call, busy information will be sent to the calling party.
- If you ignore the call, the calling party will perceive this as if you were absent (you did not pick up the call).
- Your video infrastructure may allow you to receive multiple incoming calls. Consult your video support team, if needed.

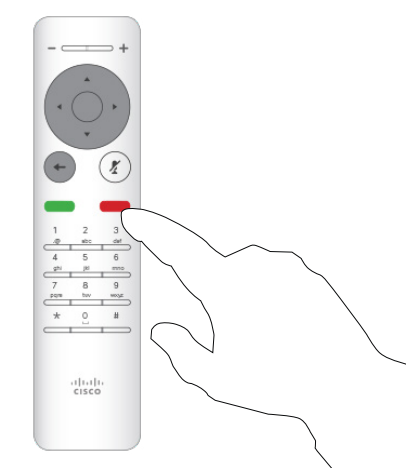
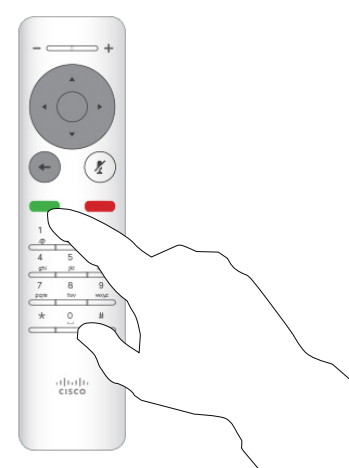

You may also use the **Call** keys below the circular buttons on the remote control directly (the green left key to accept the call and the red right key to decline).

Receive Additional Calls While Already In a Call

Expanding the Call

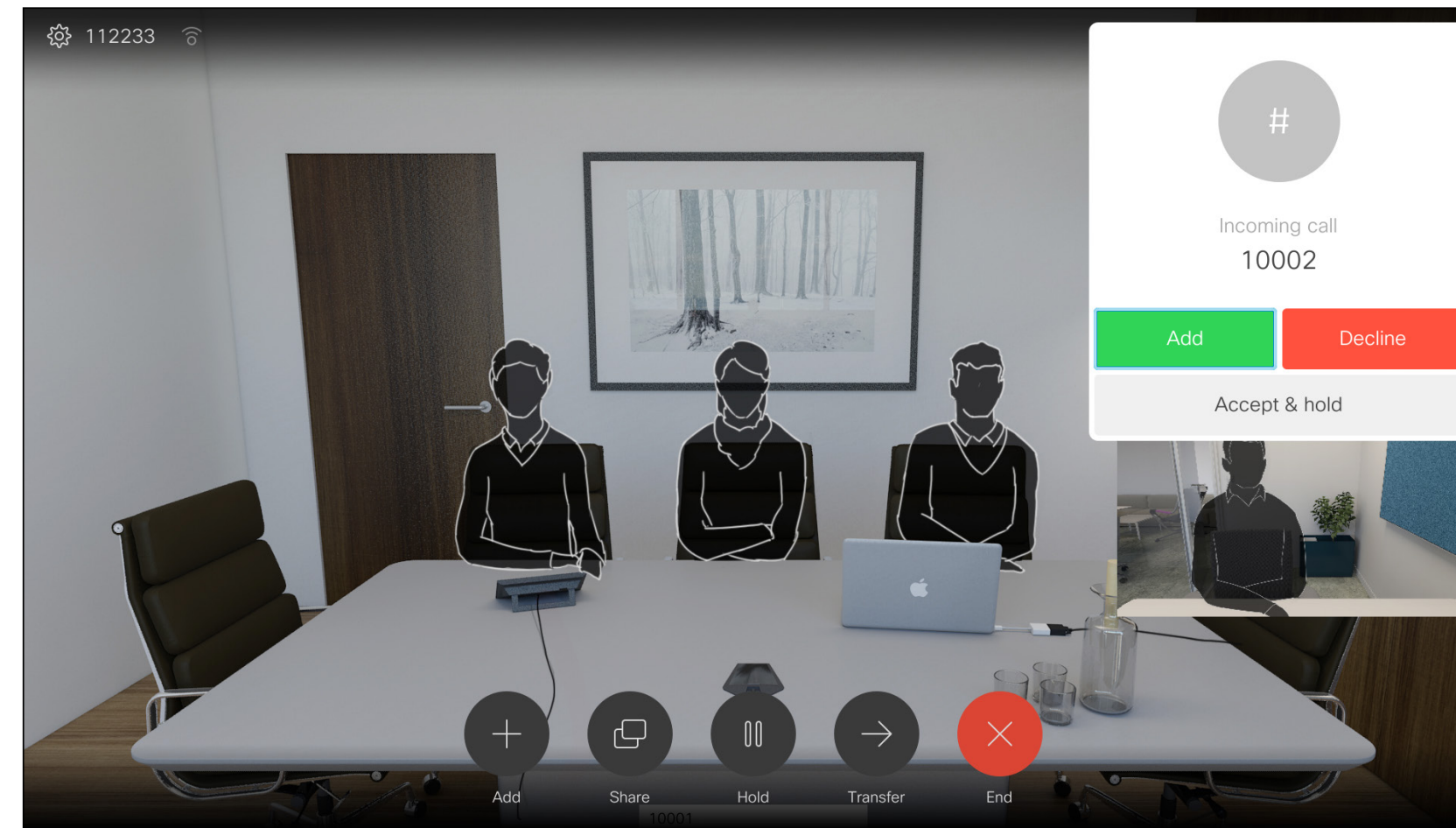

If you are already in a call, and someone calls you, you may decline the call, add the caller to the existing call or put the existing call on hold while receiving

- If someone calls you, you may accept, decline or ignore the call.
- If you decline the call, busy information will be sent to the calling party.
- If you ignore the call, the calling party will perceive this as if you were absent (you did not pick up the call).
- Your video infrastructure may allow you to receive multiple incoming calls. Consult your video support team, if needed.

Video Calls

Transfer an Ongoing Call

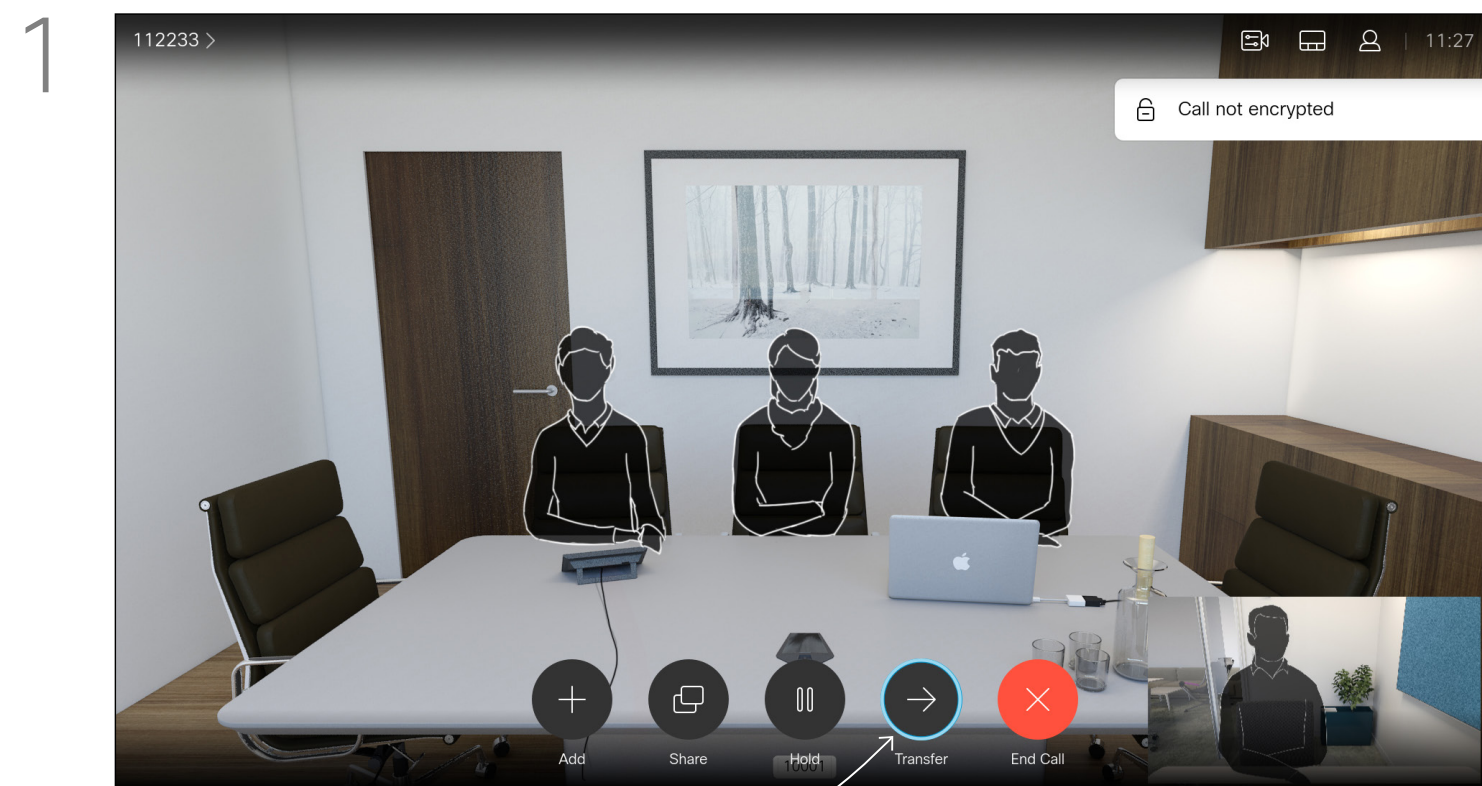

Navigate to *Transfer* and press **OK** on the remote control. This will cause the current call to be put on hold.

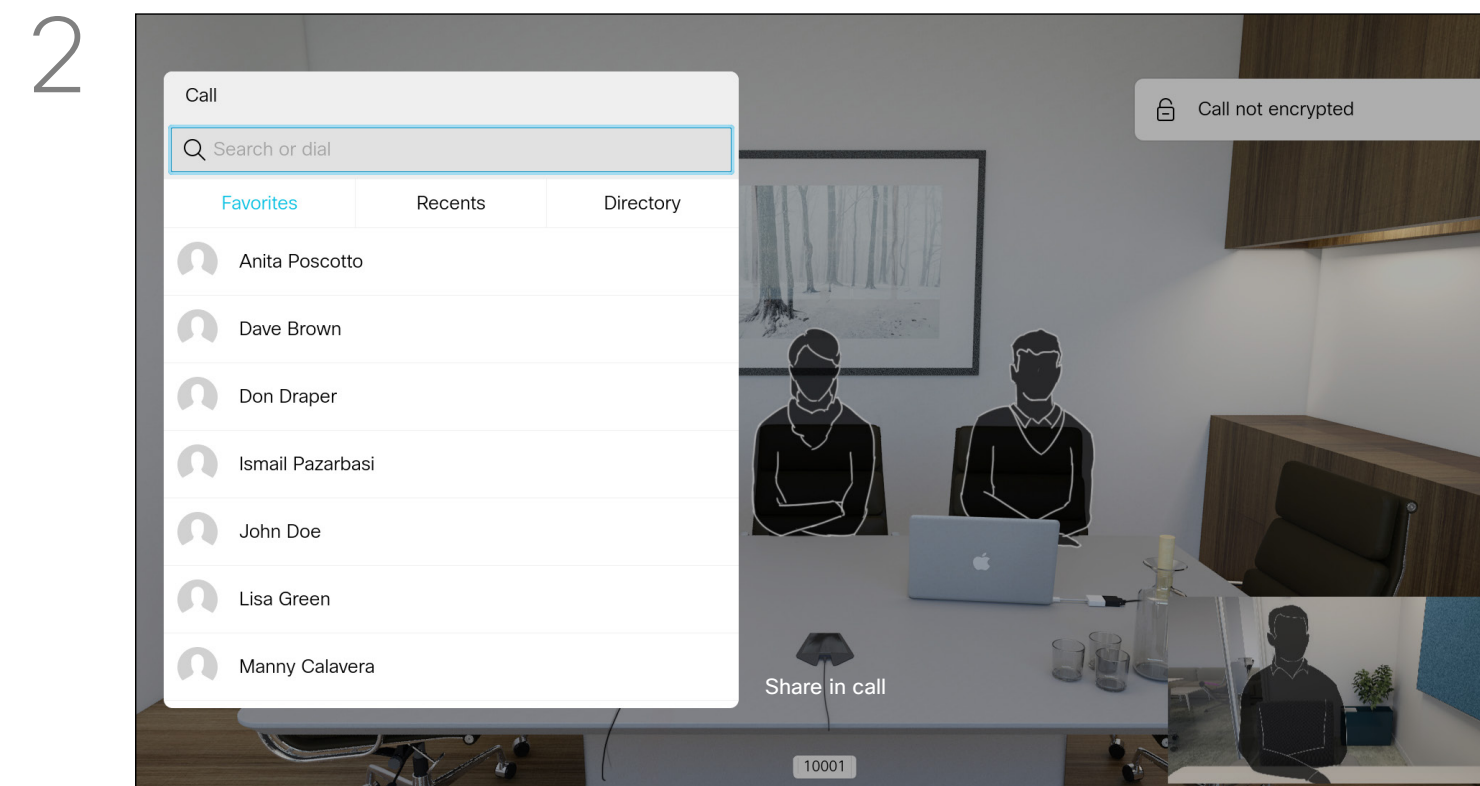

Search for whom to call in the usual way.

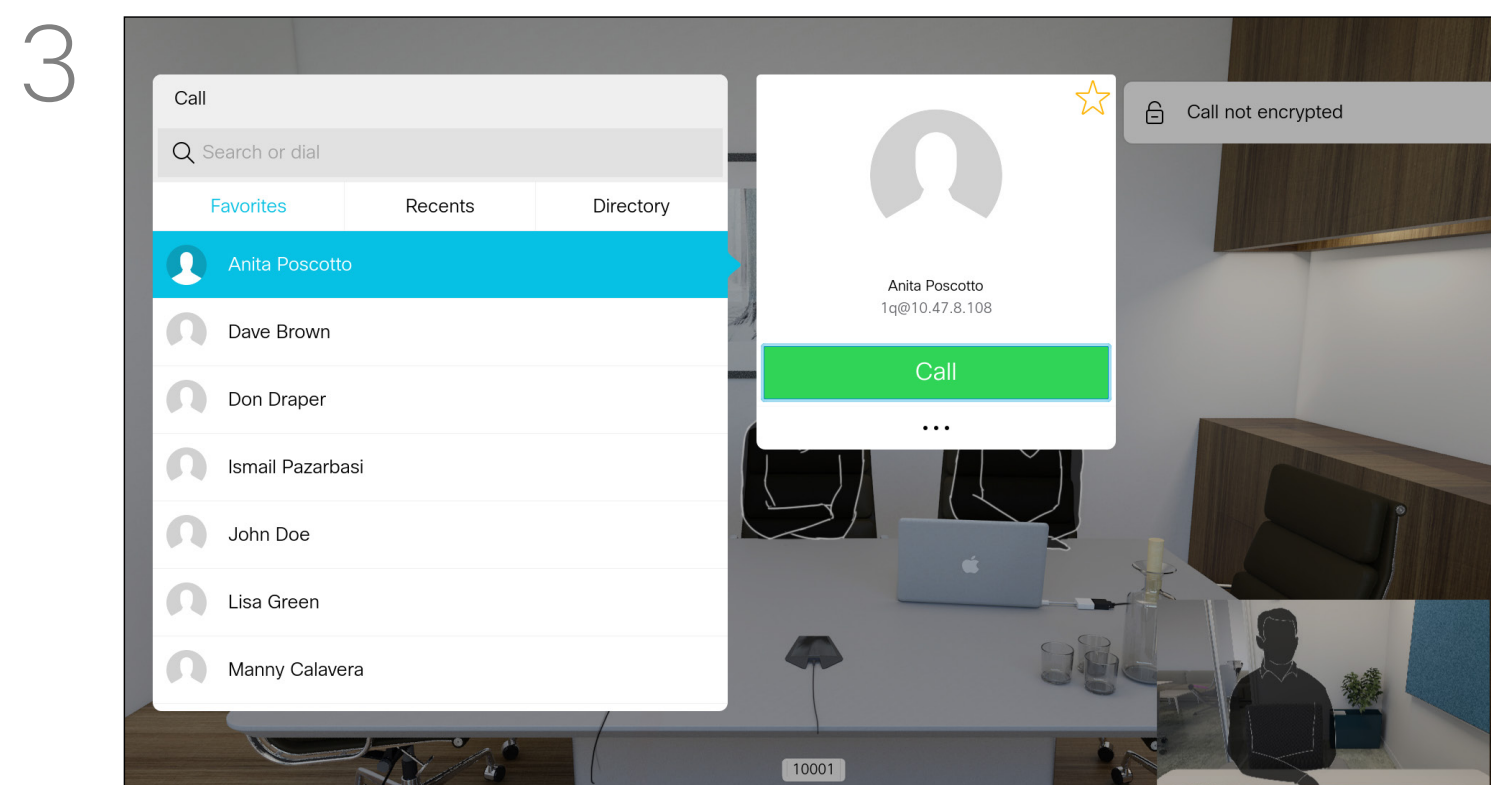

Select the green *Call* icon and press **OK** or use the green **Call** button on the remote control.

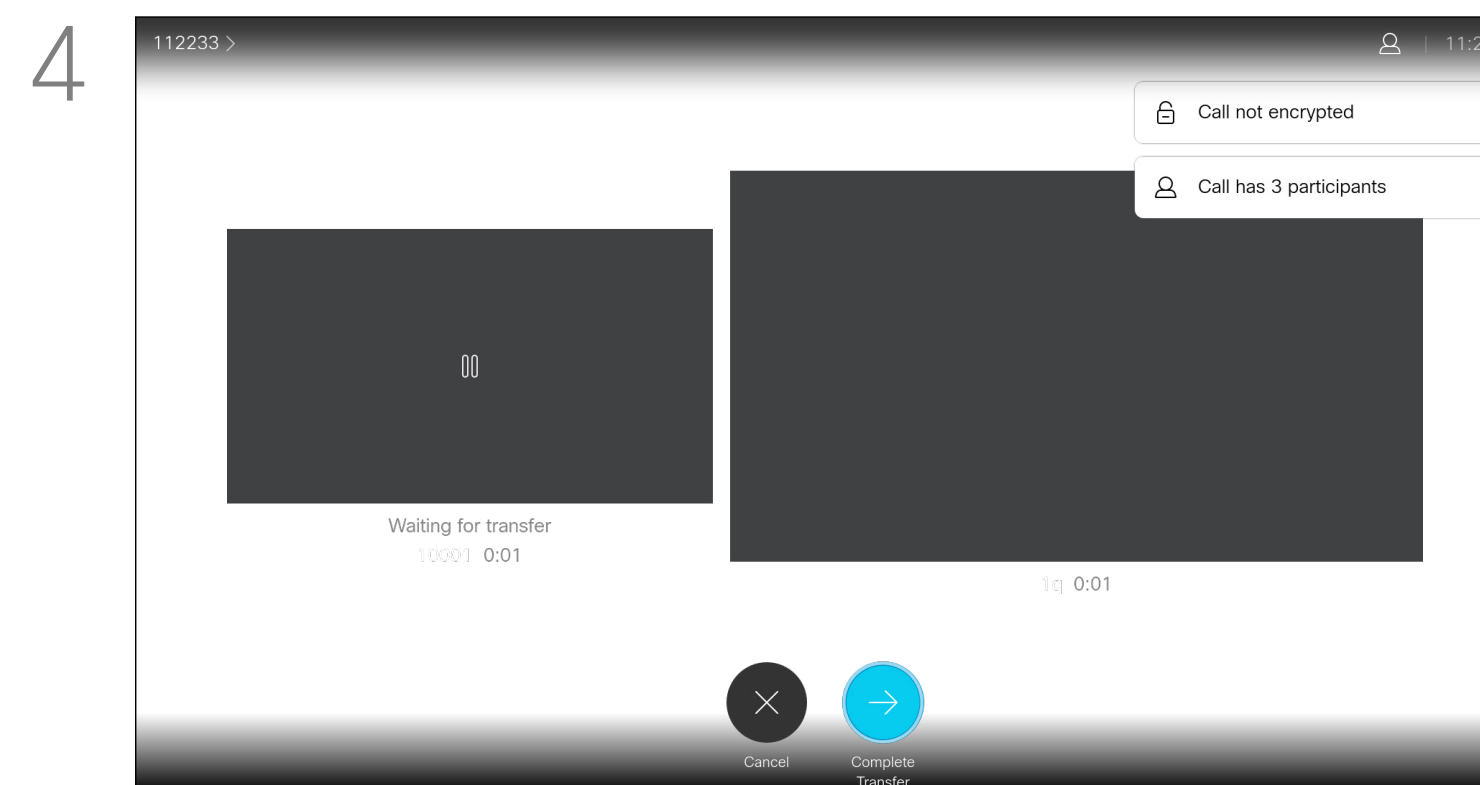

Talk to the person to confirm that transfer is OK to do. The person to be transferred is still on hold. Select *Complete Transfer* and press **OK** on the remote control.

Change the Layout of the Screen

About Layout

1

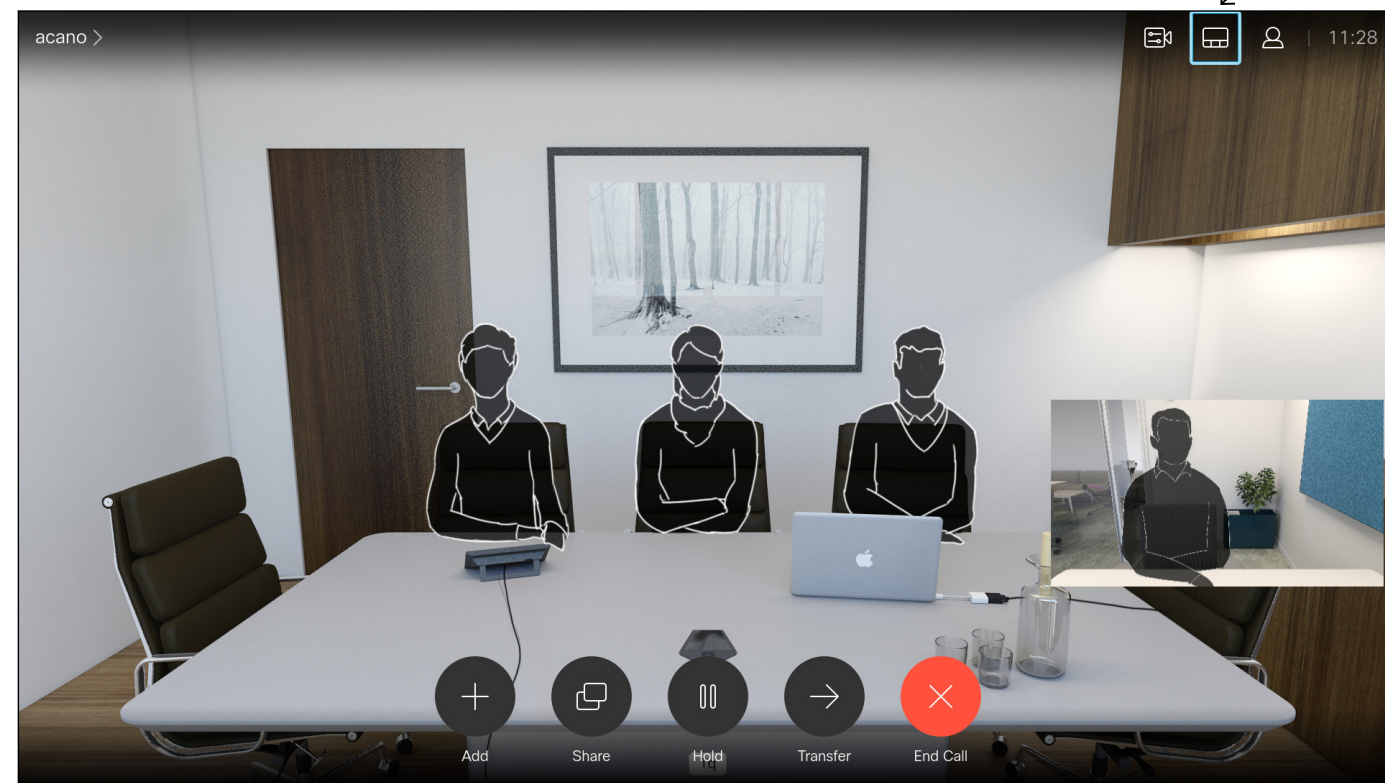

Navigate to *Layout* in the upper right corner and press **OK** on the remote control. This icon will appear only when relevant.

2

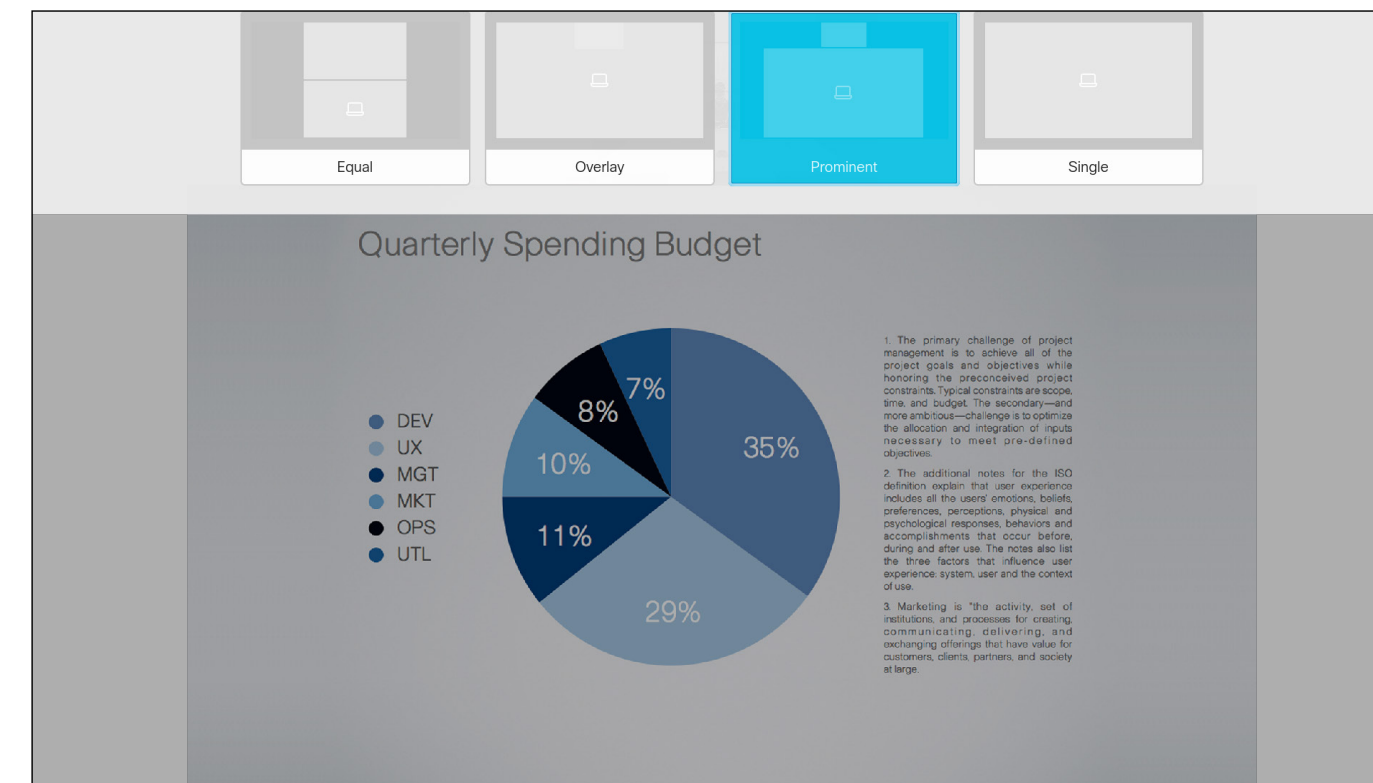

Use the **Cursor** keys to navigate to the new layout you would like to use and press **OK**.

Whenever you share content or you are in a video conference, you will be able to change the layout of the video shown on the screen.

Your system cannot initiate video conferences unless certain infrastructure exists in your organization. If in doubt, consult your video support team.

You can, however, be invited to a video conference by others. The ability to change the screen layout will then apply.

Note that the layout change options offered by the system will depend on the context and number of participants.

Any changes you make here will not affect the others.

Enable Do Not Disturb

About Do Not Disturb

Your system can be set up so that it does not respond to incoming calls. When set to Do Not Disturb, ringtones are muted and call attempts made by others to reach you will appear as missed calls. You may, however, place calls as much as you like.

As default, there is a 60 minutes timeout on the Do not disturb (after which the system will return to normal operation), but this may have been changed to a different setting by your Video Support Team.

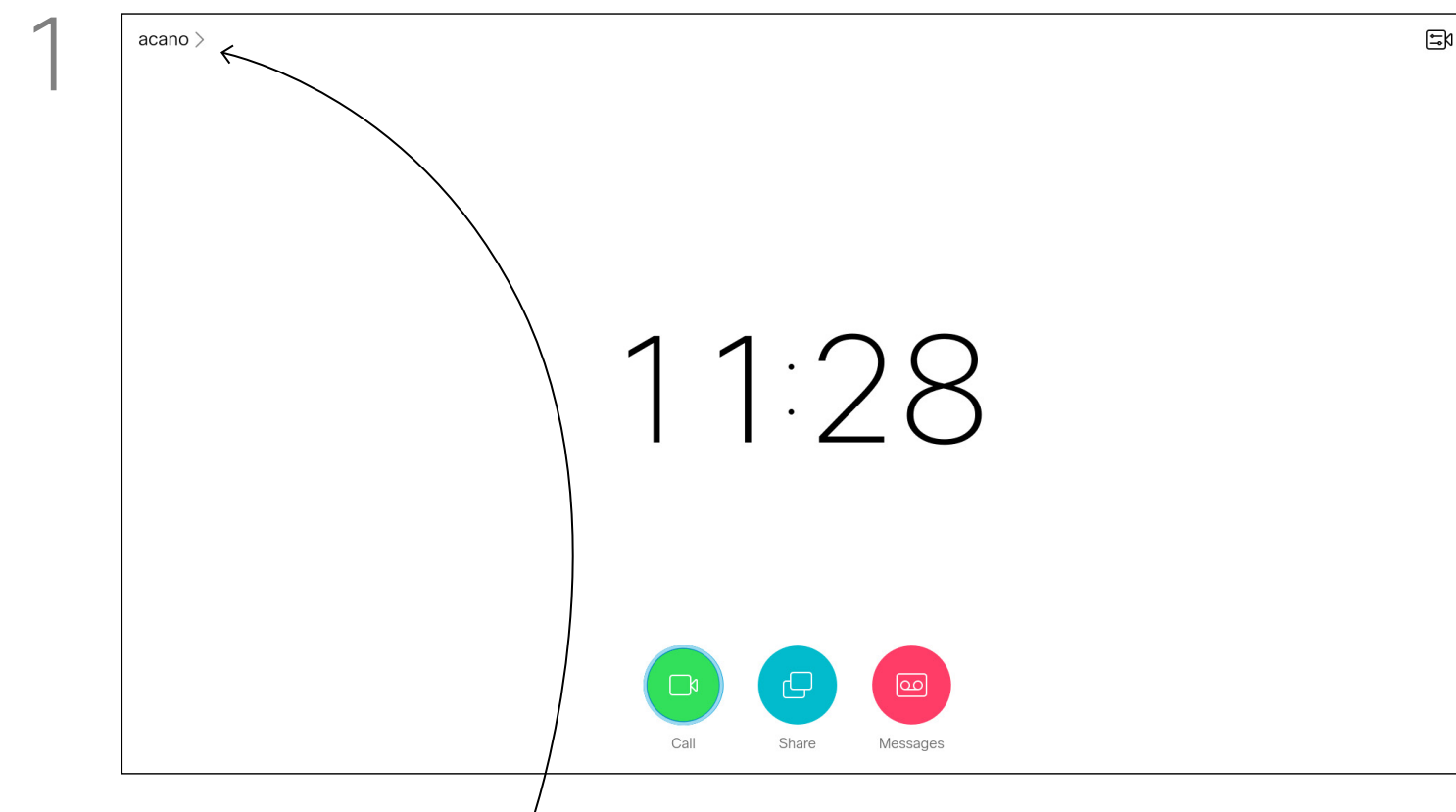

Starting from *Home* screen, use the **Cursor** keys on the remote control to select the *More* icon (>) in the upper left corner of the screen.

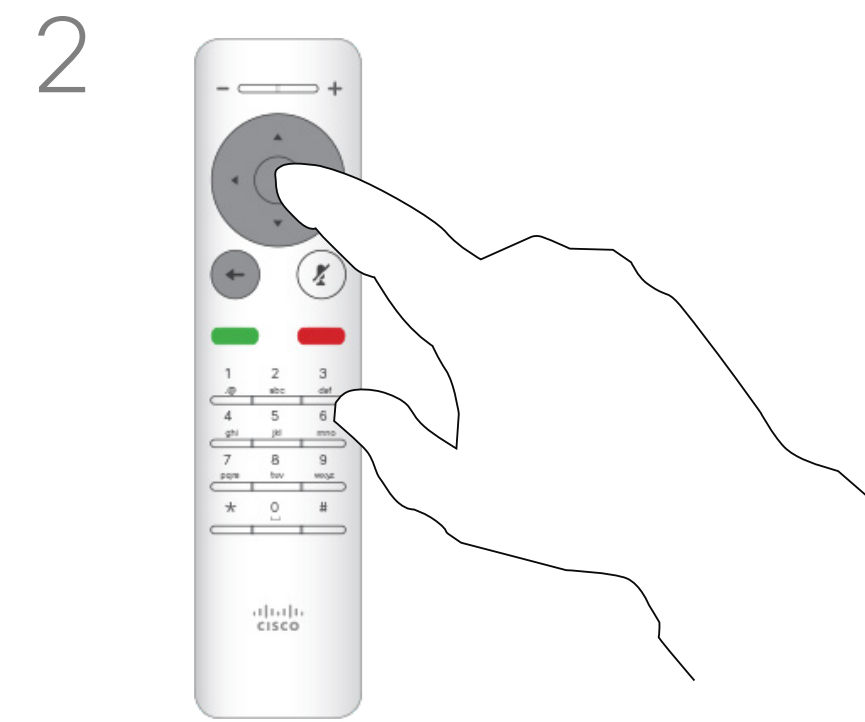

Press **OK** on the remote control.

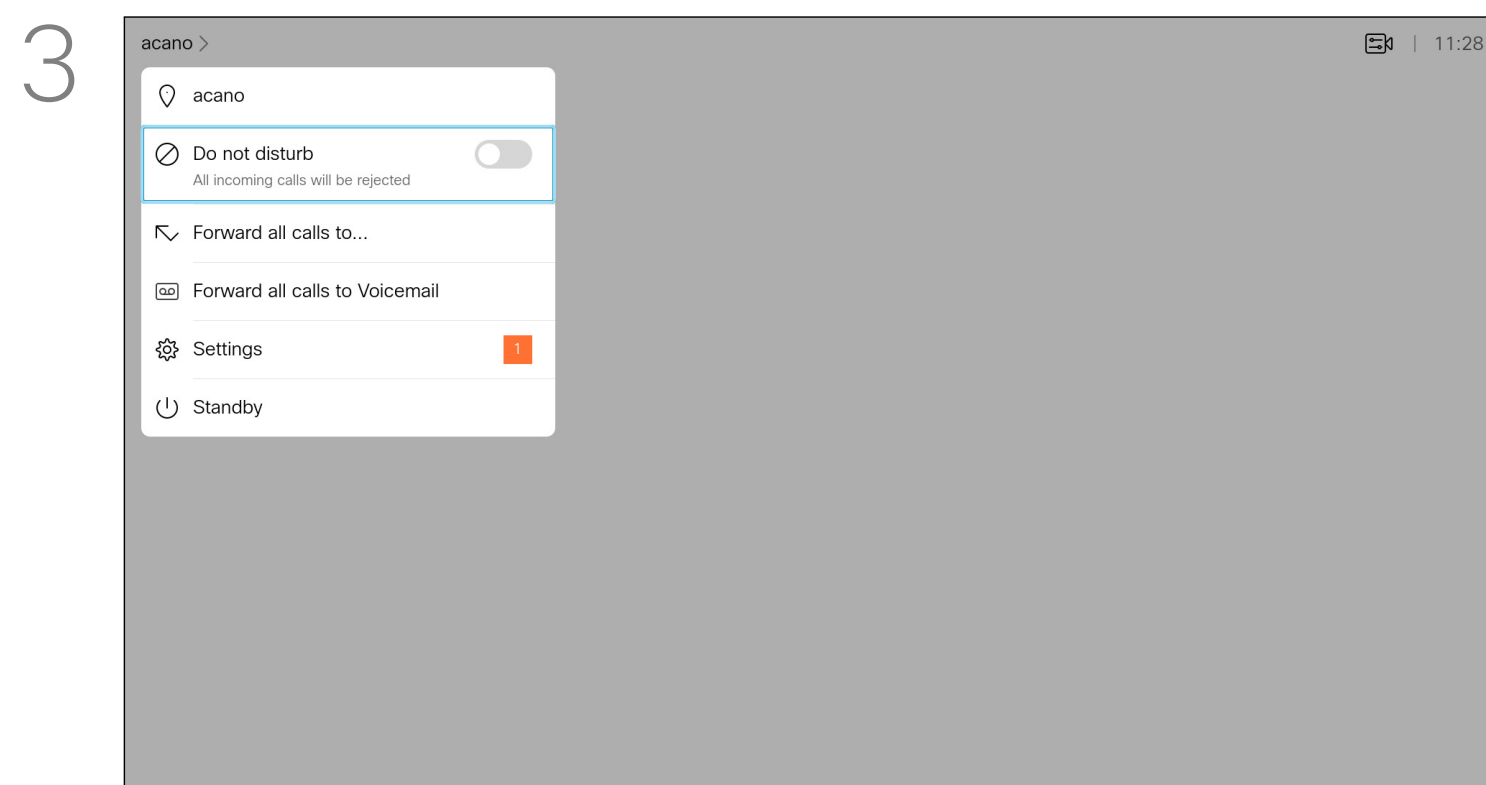

Use the **Cursor** keys on the remote control to navigate down to *Do Not Disturb* and use the **OK** button on the remote control to set it to On or Off (toggling).

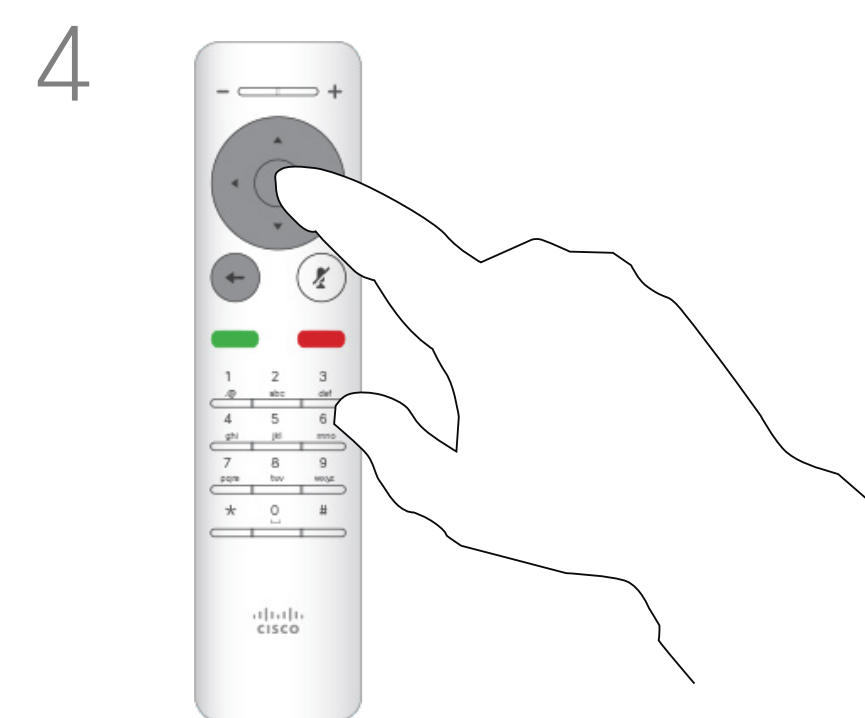

Press the **OK** key on the remote control to exit the menu, putting changes into effect.

Video Calls

Enable Standby

About Standby

Your system can be set to Standby to save power. You will still be able to receive calls as usual.

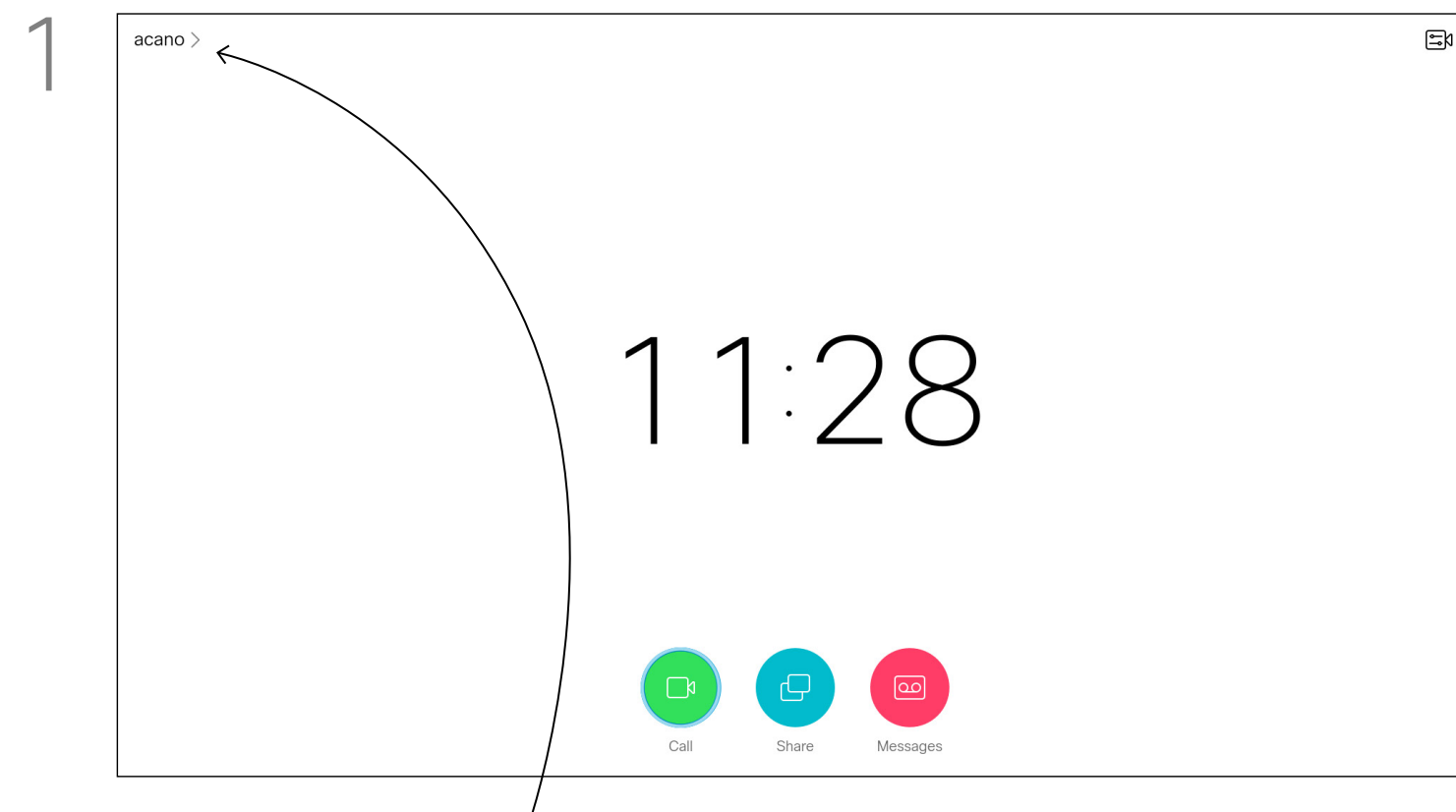

Starting from *Home* screen, use the **Cursor** keys on the remote control to select the *More* icon (>) in the upper left corner of the screen.

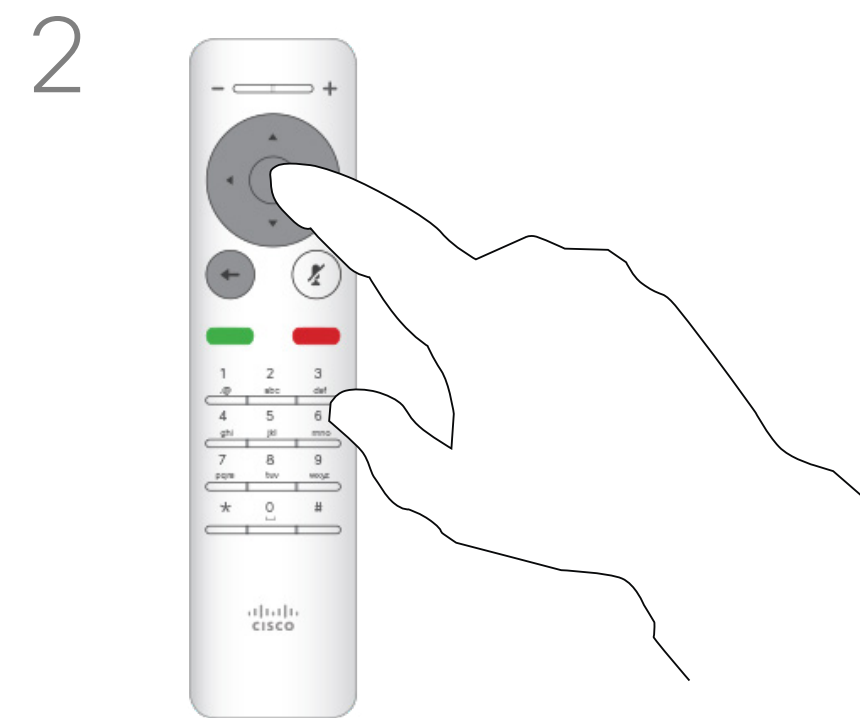

Press **OK** on the remote control.

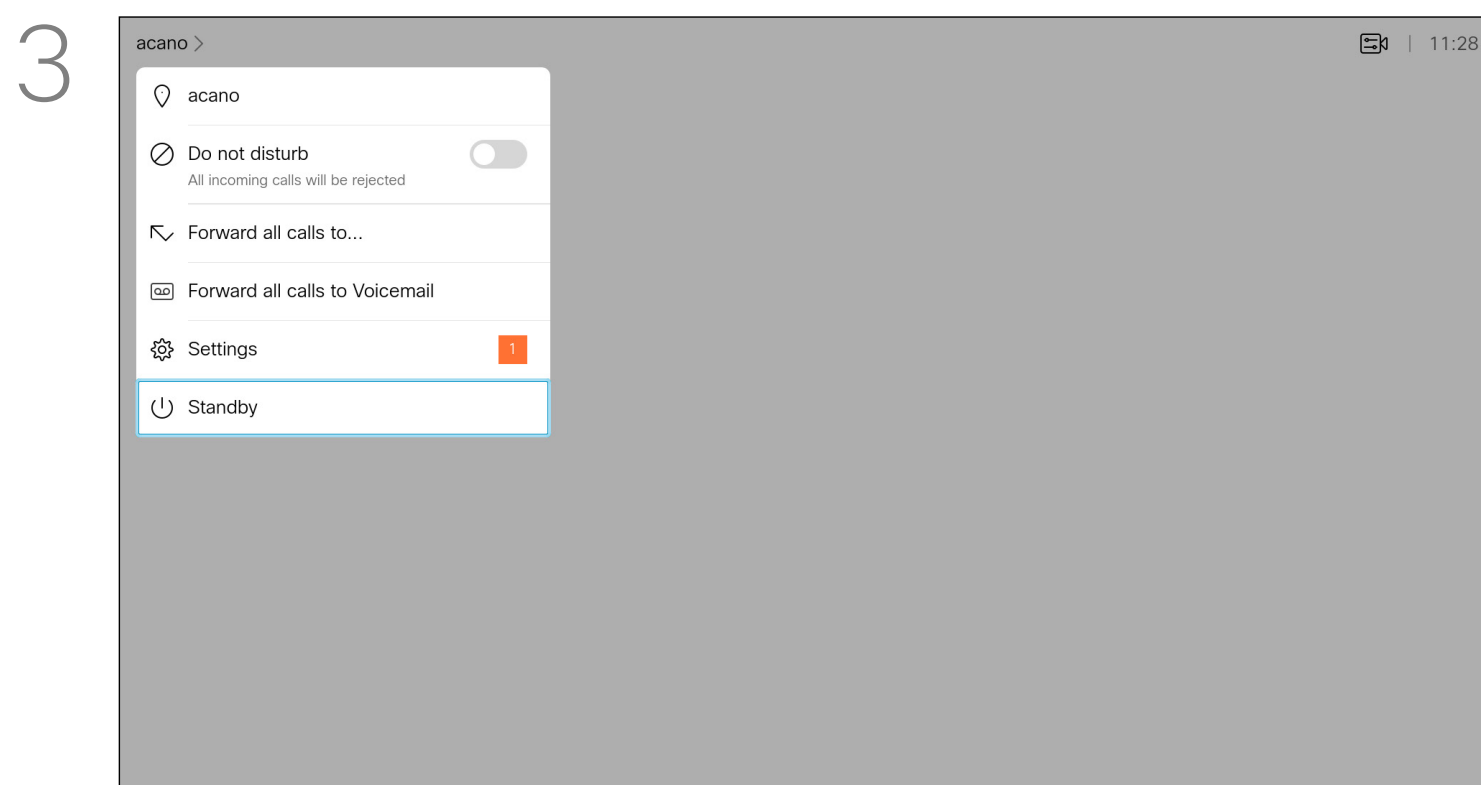

Use the **Cursor** keys to navigate down to *Standby*.

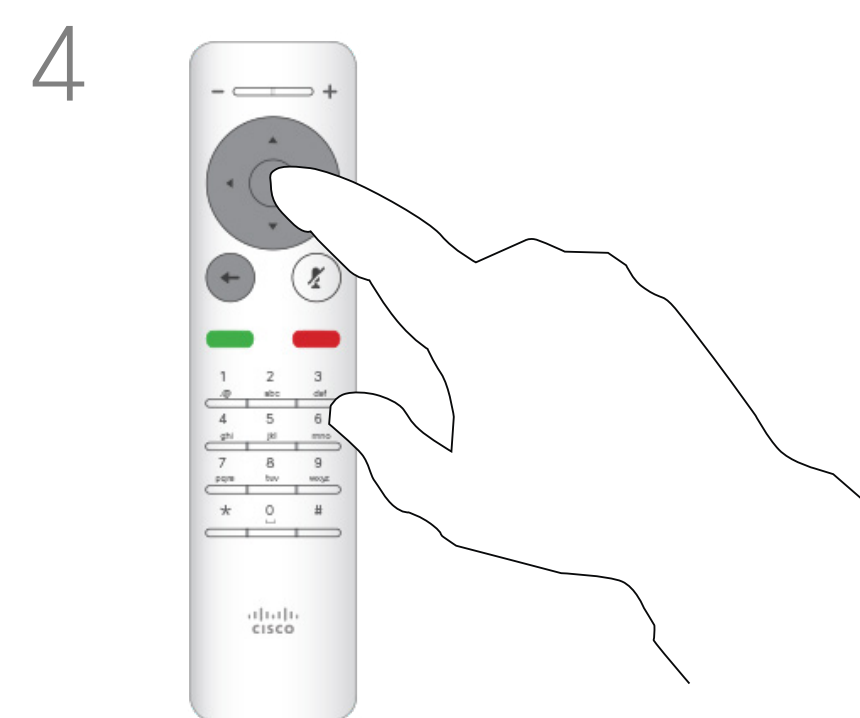

Press the **OK** key on the remote control to exit the menu, putting changes into effect.

Forward All Calls

About Forwarding

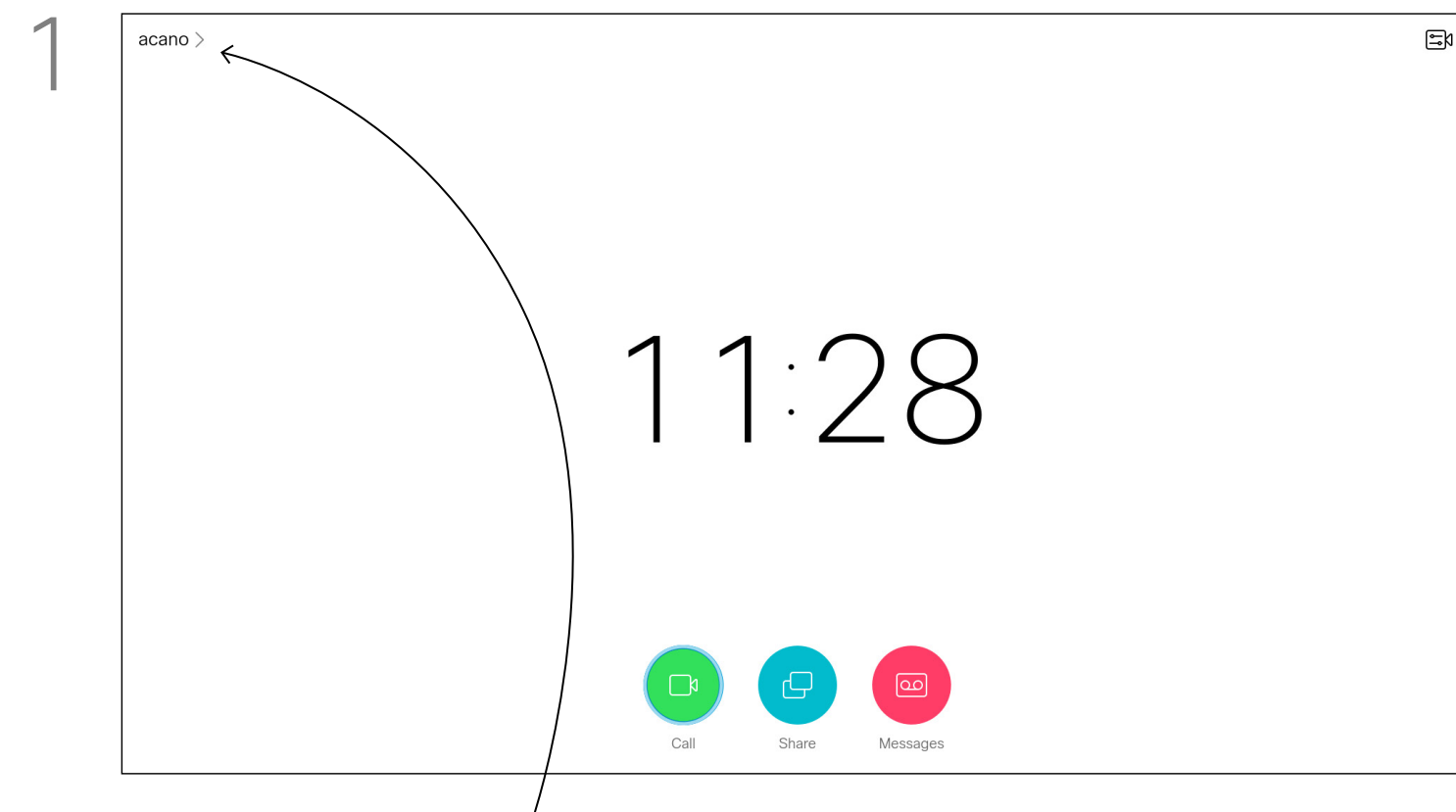

Starting from *Home* screen, use the **Cursor** keys on the remote control to select the *More* icon (>) in the upper left corner of the screen.

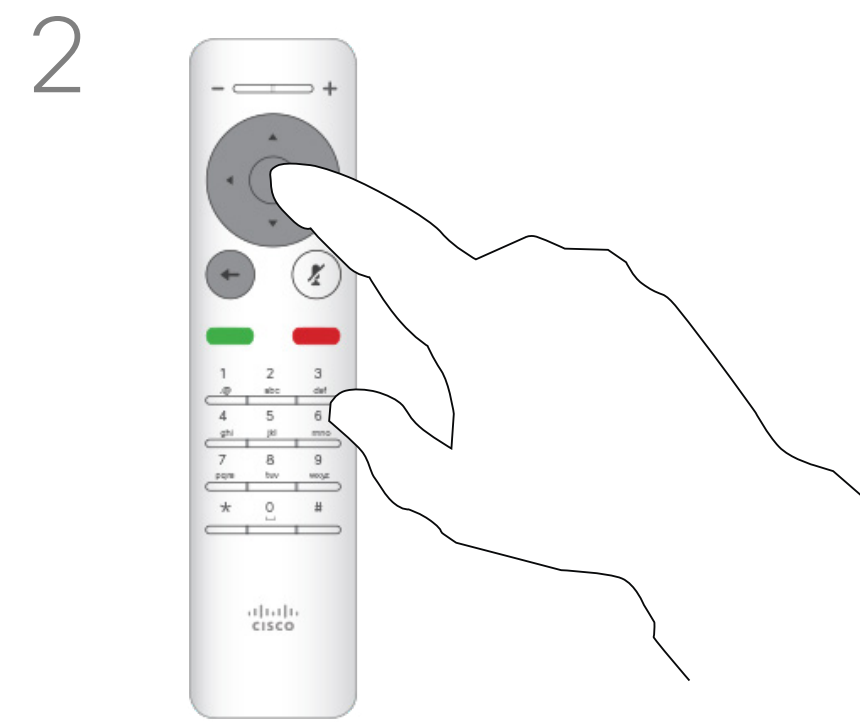

Press **OK** on the remote control.

Your video support team may have activated the option of forwarding all calls received. You may then choose between voicemail and a receiver appointed by you.

If you select *Forward all calls*, the familiar *Call* menu will appear letting you specify whom to receive your calls.

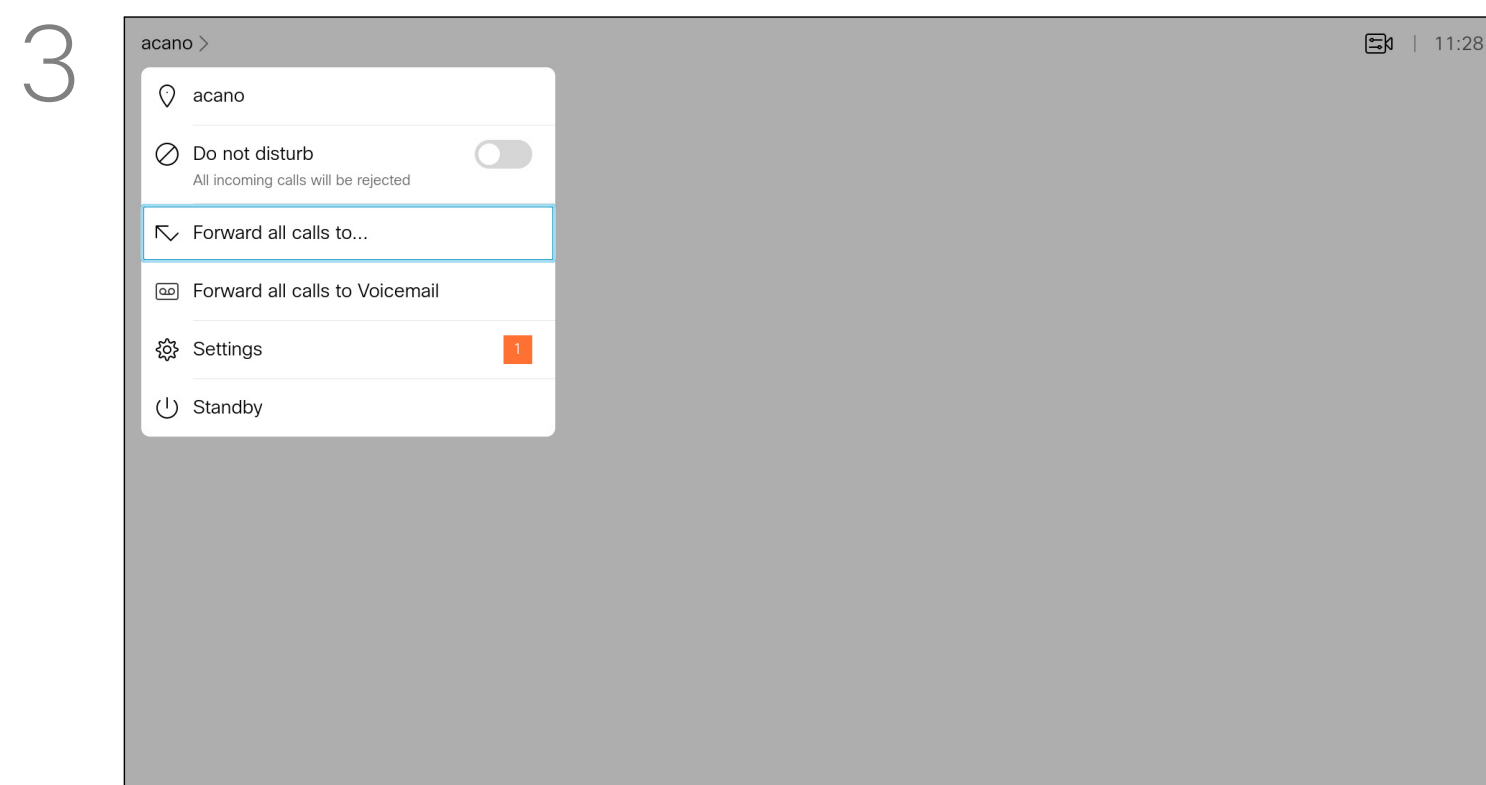

Use the **Cursor** keys to navigate to *Forward all calls to...* . If you want to forward all calls to Voicemail instead, navigate to *Forward all calls to Voicemail*, press **OK** and you are done.

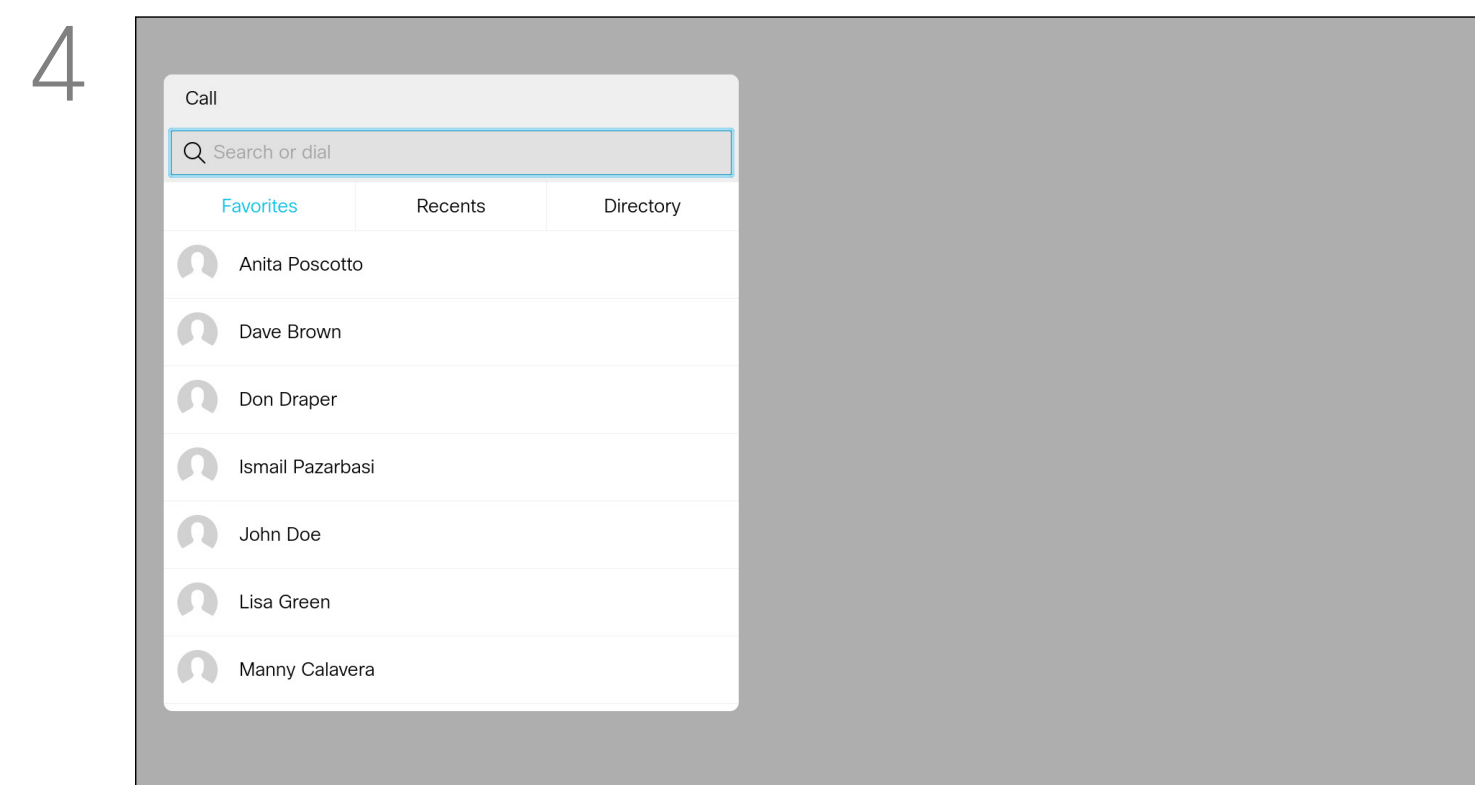

Choosing *Forward all calls to...* will send you to the *Call* menu. Select whom to receive all calls in the same way as if you were about to call that person.

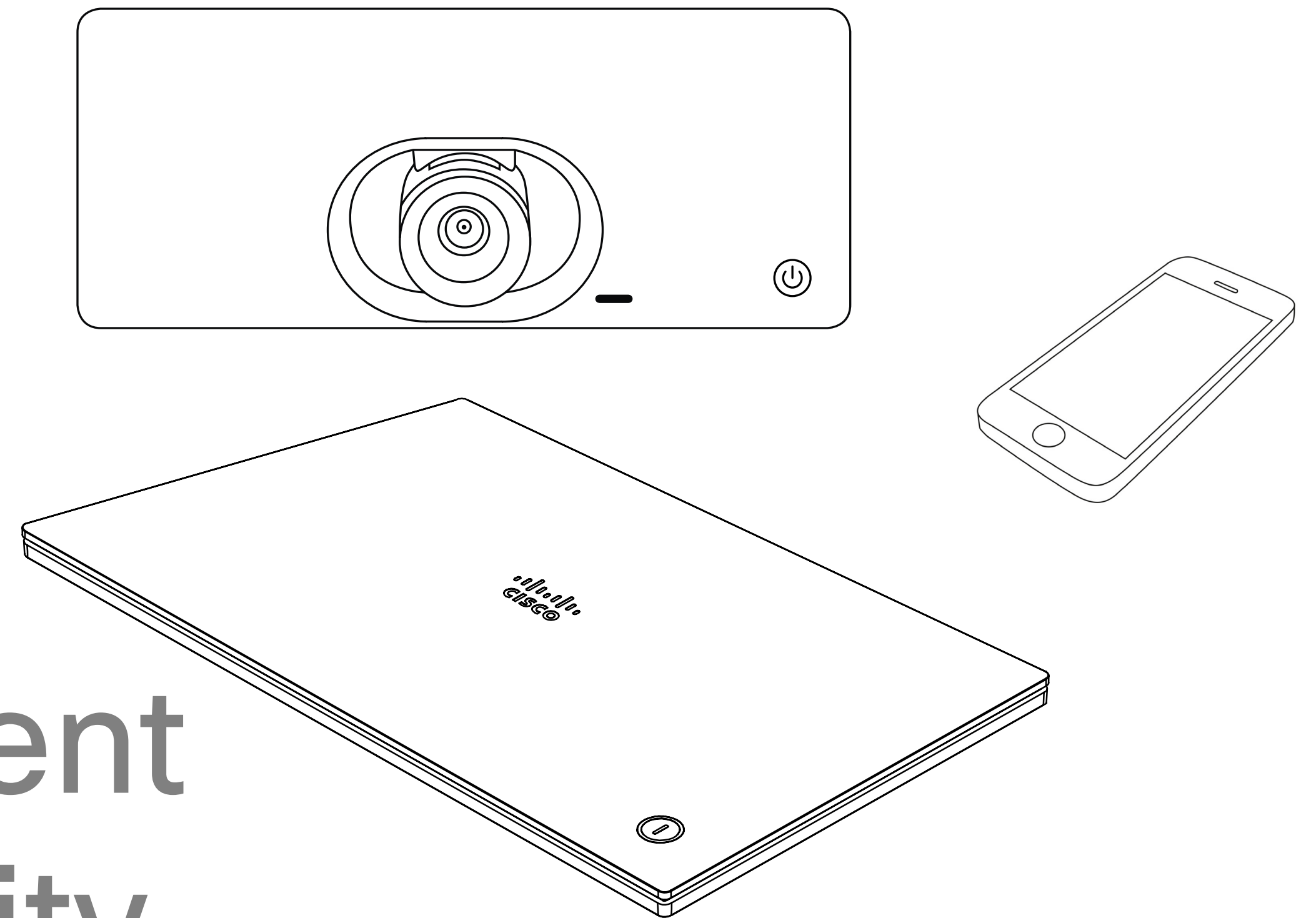

Intelligent Proximity

On the Cisco Proximity Ultrasound Signal

About Proximity

Cisco video systems emit ultrasound as part of the Proximity feature. Most people are exposed to ultrasound more or less daily in many environments, including industry, commercial applications and home appliances.

Even if airborne ultrasound may cause subjective effects for some individuals, it is very unlikely that any effects will occur for sound pressure levels below 75 dB. Guidelines for ultrasound exposure limits vary heavily between countries, but 75 dB is the lowest limit presently found for the frequency band around 20 kHz, which is where the Cisco proximity signal is emitted.

A good reference for this information is Health Canada's guidelines, http://www.hc-sc.gc.ca/ewh-semt/pubs/radiation/safety-code_24-securite/index-eng.php#a2.2.2.

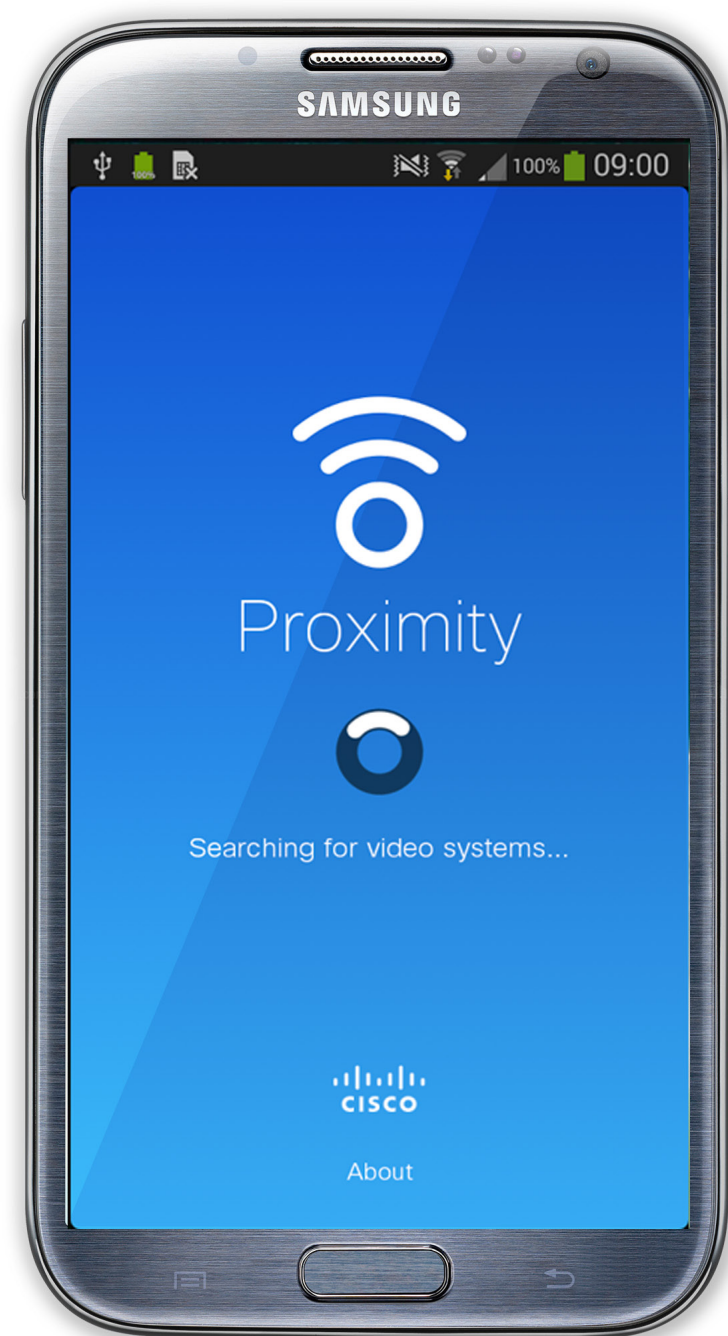

These guidelines state that sound pressure levels lower than 120 dB have not been demonstrated to cause hearing losses, neither permanently nor temporarily.

For Cisco video systems for group use with integrated loudspeakers the ultrasound sound pressure level is below 75 dB at a distance of 50 cm or more from the loudspeaker.

For Cisco video systems for personal use the ultrasound sound pressure level is below 70 dB at a distance of 20 cm or more from the loudspeaker.

For Cisco WebEx Boards the ultrasound sound pressure level is below 75 dB at a distance of 20 cm or more in front of the display. The level can be slightly higher right below the display due to the downward-facing loudspeakers.

In most practical cases the level at the ear of the user will be much lower than these max levels, due to loudspeaker directivity, distance attenuation, and high degree of high frequency absorption in typical rooms. The levels will range from what for audible sound would be typical background / ambient noise levels in meeting spaces up to so-called conversational levels of normal speech.

It is therefore deemed safe for humans to be continuously subjected to the proximity signal. Most people will not be aware of the presence of the signal, and suffer no effects from it. A few individuals with especially acute high frequency hearing can, however, be able to hear it, this is most likely to happen directly in front of and close to the loudspeaker.

It is obvious that animals like dogs will hear the proximity signal, since their frequency range of hearing is so much wider.

However, the effect of sound is also level dependent, and the level range of a dog's hearing is not significantly different from that of a human. The hearing threshold of dogs at 20 kHz can be as low as 0-10 dB, similar to the threshold of a human ear in its most sensitive frequency range.

Cisco has not done testing or qualification of the possible effects the signal can have on dogs. Due to the limited levels it is believed that while the signal is clearly audible it is not bothersome to dogs.

A dog in an office or meeting room will be subject to ultrasound at levels comparable to normal background noise, or at most conversational levels. There has been no reports of animals being bothered by the signals in the years we have had this feature in our products. However, the question of ultrasound effect on dogs is fair, since dog repeller devices using ultrasound do exist. These devices typically claim to use discomforting, but not harmful ultrasound. Cisco does not have insight into dog repeller design, but scanning the specifications of such devices typically reveals that the exposure levels typically are 100 dB and upwards.

For solutions using Cisco video codecs with 3rd party loudspeaker systems Cisco is not able to control the ultrasound sound pressure level. In most cases the necessary loudspeaker sensitivity and frequency response will result in levels below the 75 dB limit. However, if excessive external amplification is applied, or the loudspeaker system has an emphasized high-frequency response, levels in excess of the limit can be produced.

The Intelligent Proximity feature allows you to share content from a video system wirelessly on your own device (smart phone, iPad, Android tablet, PC or Mac).

You can also use your own device (smart phones and tablets only) to control calls on the video system.

Observe the following:

You will need to download (free of charge) the Cisco Intelligent Proximity app from App Store or Google Play.

Windows or OS X users, go to <https://proximity.cisco.com/>.

Your video support team may have activated none of the features, all of them, or just a subset of them.

Intelligent Proximity makes use of ultrasound when connecting users (see more at left). Do not block the microphone of your computer, smart phone or tablet.

Intelligent Proximity has been designed not to work outside the meeting room when doors to the room are kept closed. You will need to be in close proximity of the video endpoint to use the feature.

When privacy dictates, always keep the meeting room entrance doors closed to avoid possible eavesdropping from adjacent rooms.

Content Sharing

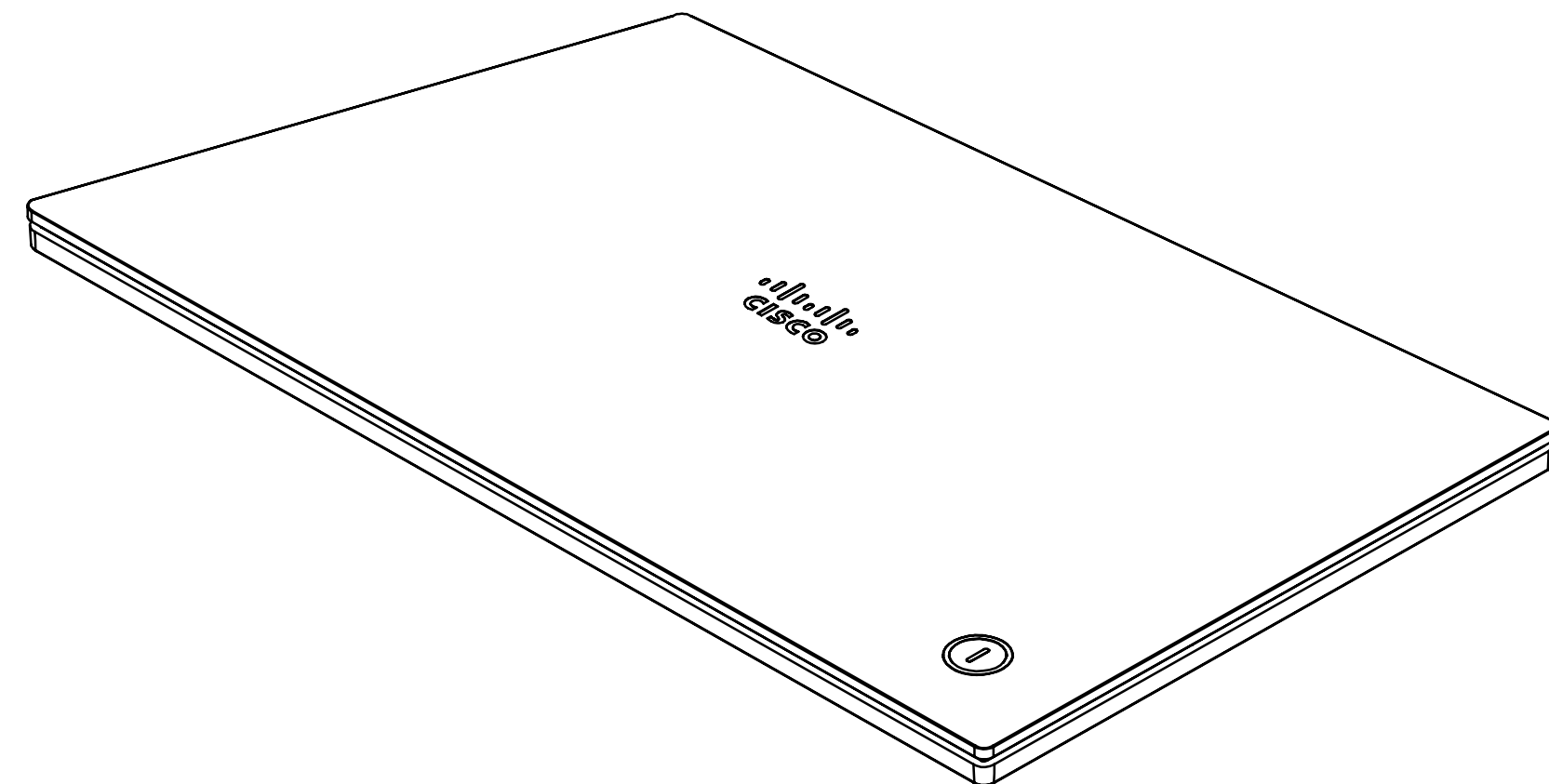

Content Sharing

Start and Stop Presentation

About Content Sharing

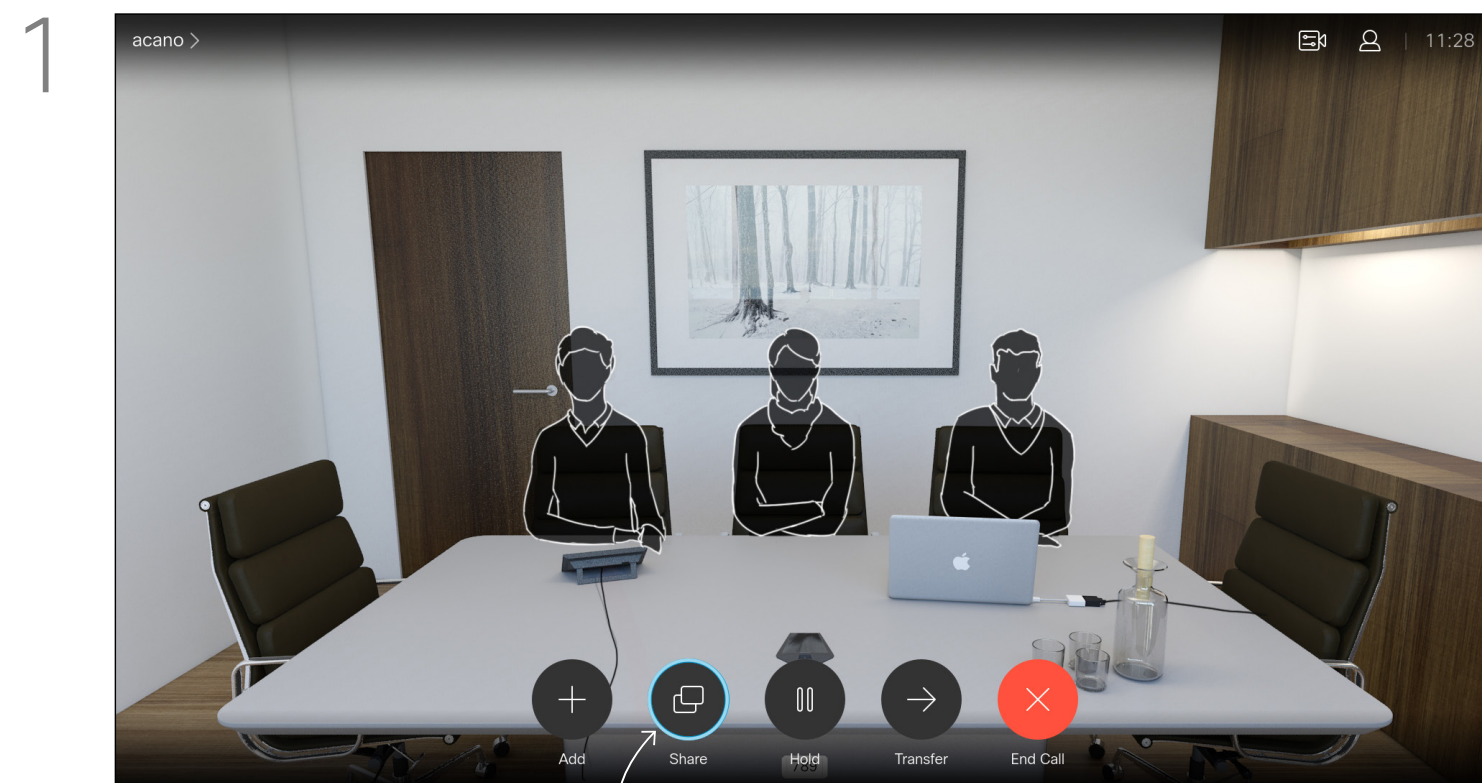

Make sure your presentation source is connected and On. You may need to select *Share* and press **OK** on the remote control.

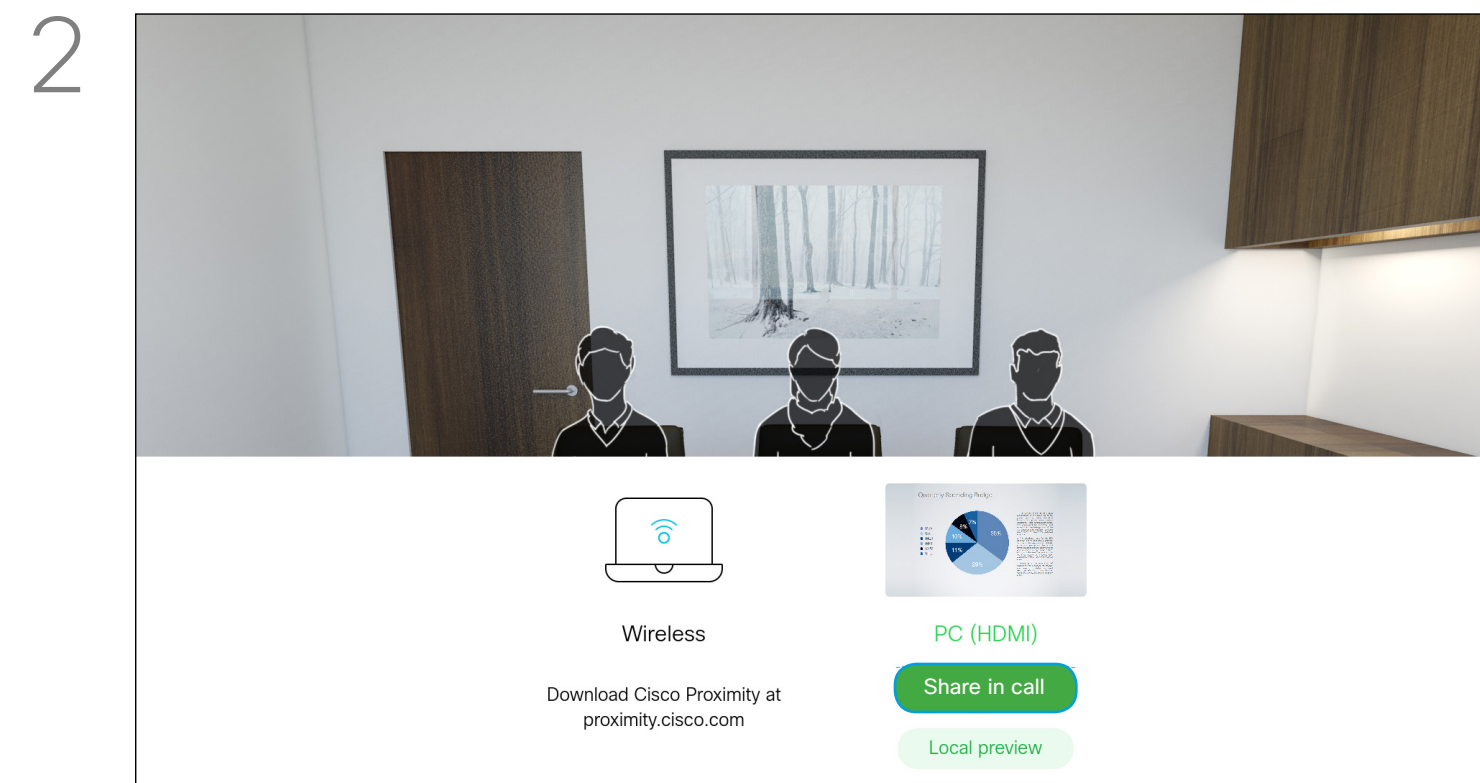

You may now select *Local preview* to inspect the contents without sharing it with the others, before you select **Share in call** to share it with the others.

Use this feature to share content on your PC in a call or outside a call. The procedure is the same, but shown here is the in-call way only. To share content using Proximity, make sure your presentation source has Cisco Proximity installed and activated. Allow some time for the pairing to take place. Follow on-screen instructions.

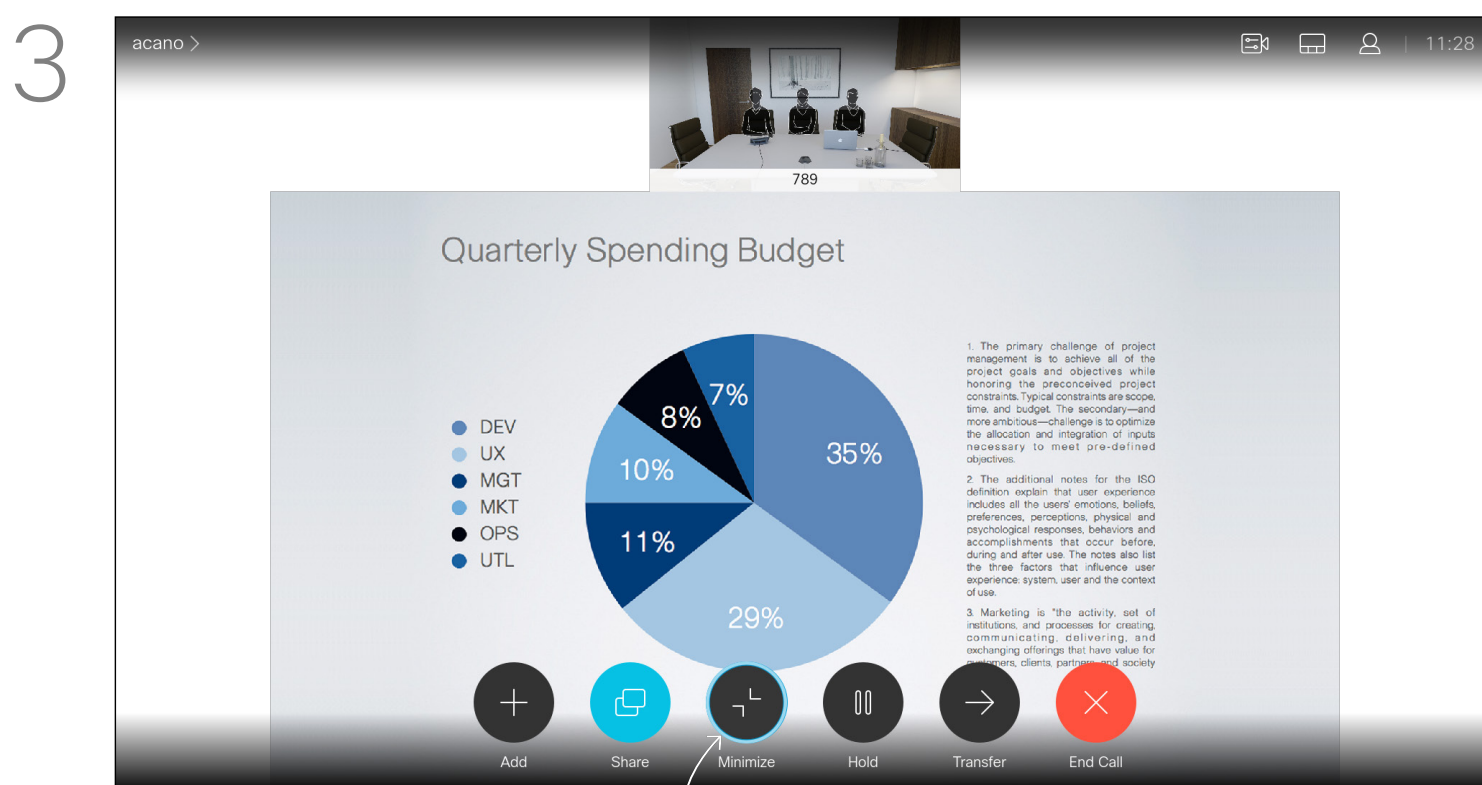

The size of the shared image is controlled by means of the *Minimize/Maximize* icon. Select this and press **OK** on the remote control, if needed.

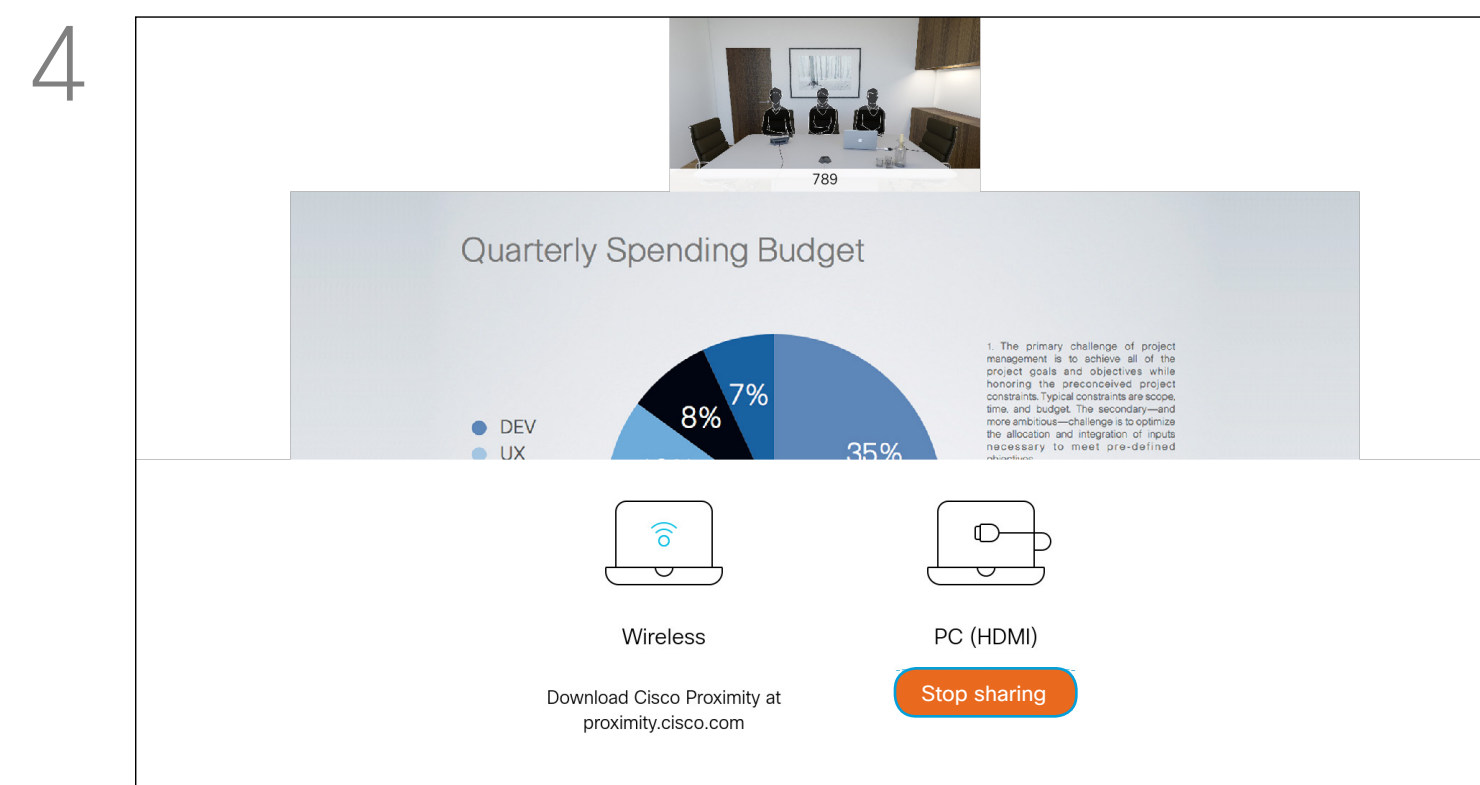

To stop sharing content, select *Stop sharing* and press **OK** on the remote control.

Change Presentation Layout In a Call

1

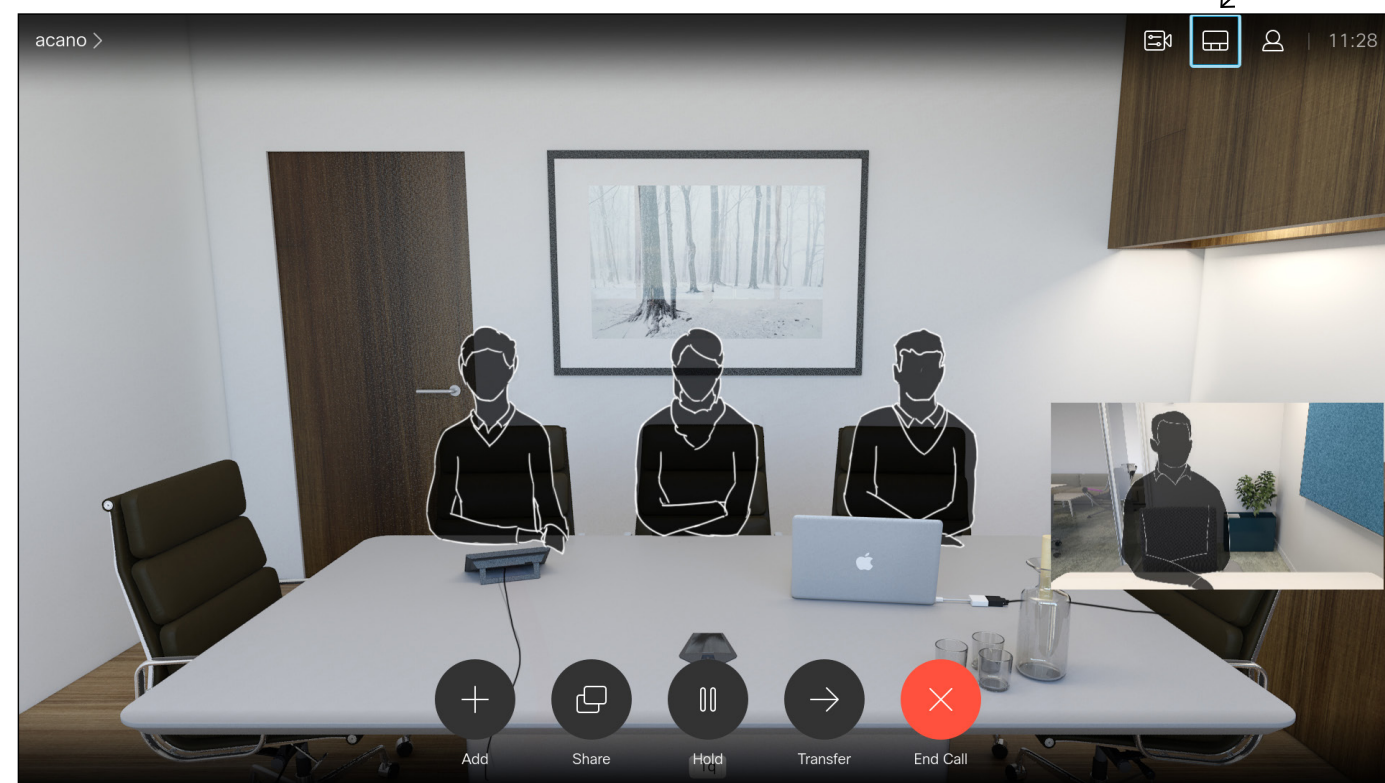

Navigate to *Layout* in the upper right corner and press **OK** on the remote control. This icon will appear only when relevant.

2

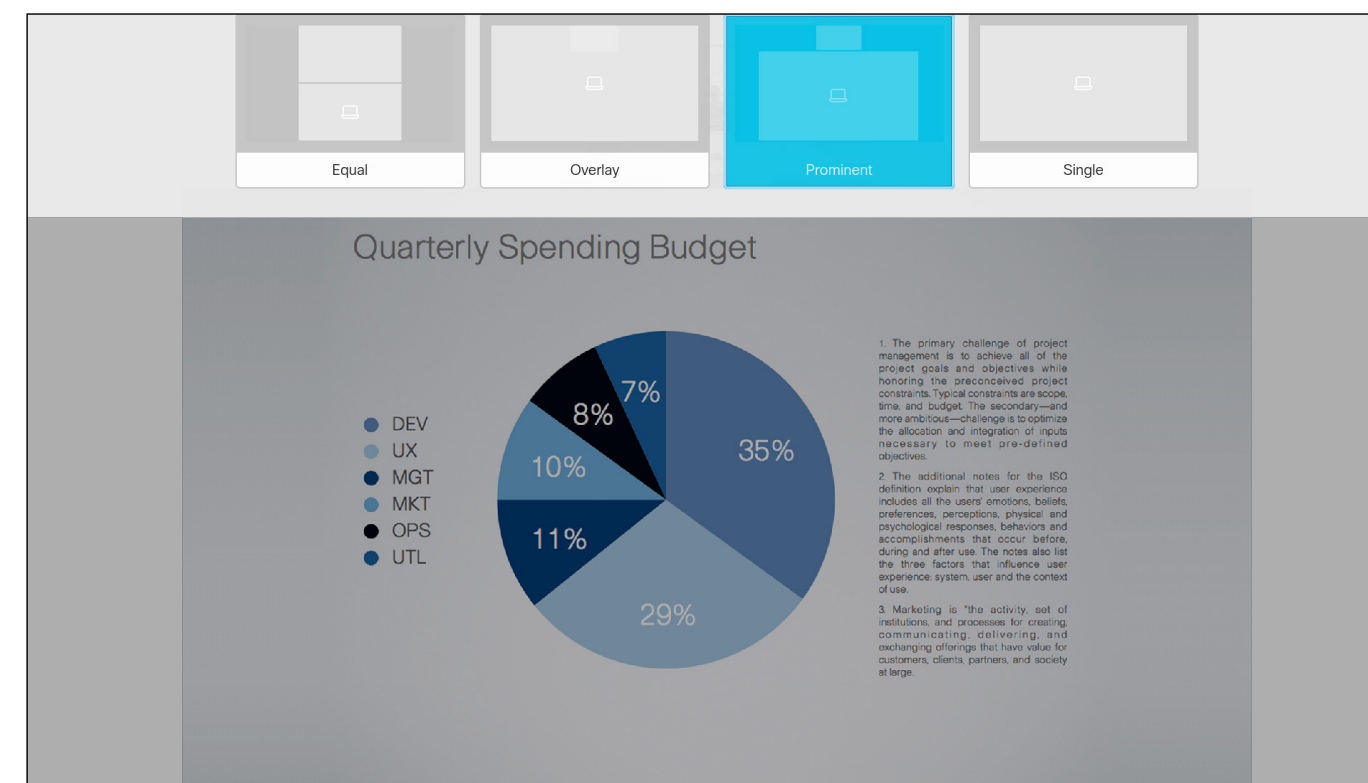

Use the **Cursor** keys to navigate to the new layout you would like to use and press **OK**.

You may change the layout of the screen during presentations. Typical options available will be with or without showing the presenter and showing the presenter as either a PiP (Picture in Picture) or PoP (Picture outside Picture).

The layout options available on your system may differ from those shown here, but the layouts shown are always those you may choose between.

Scheduled Meetings

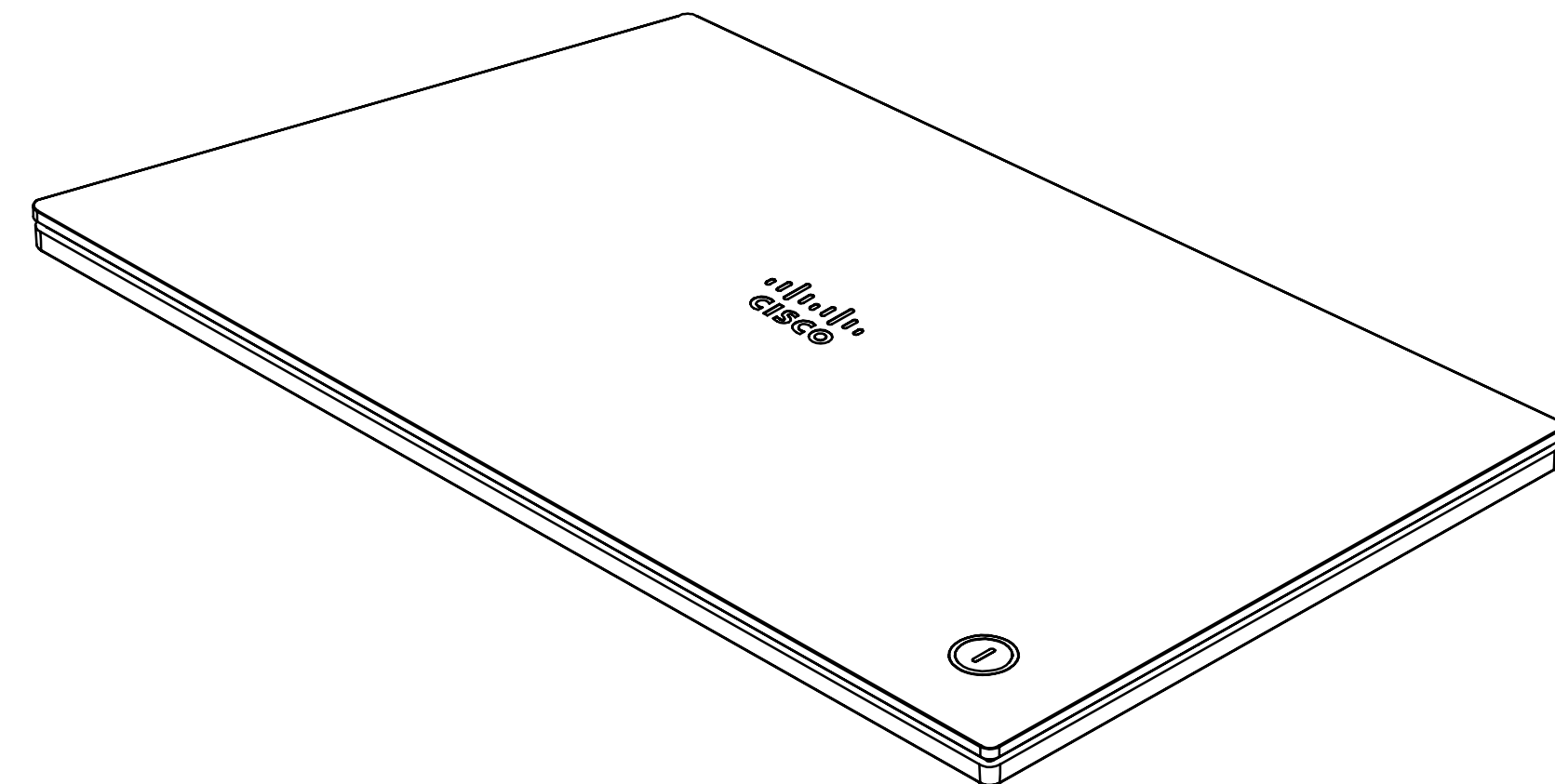
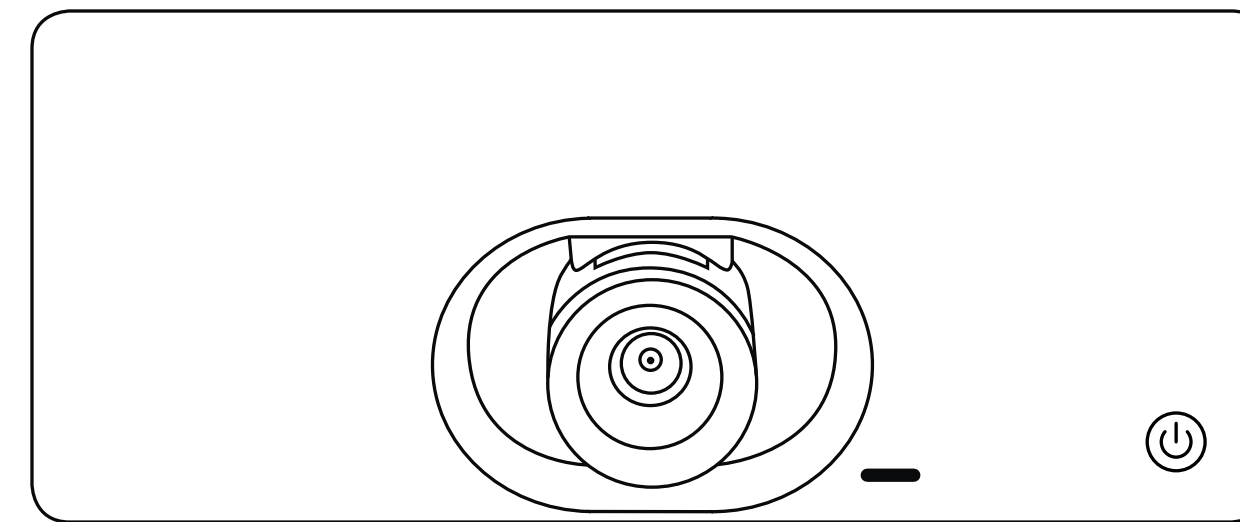

Join a Scheduled Meeting

A meeting allowing you to join in, can be joined by navigating to the green *Join* icon. Then click **OK** on the remote control.

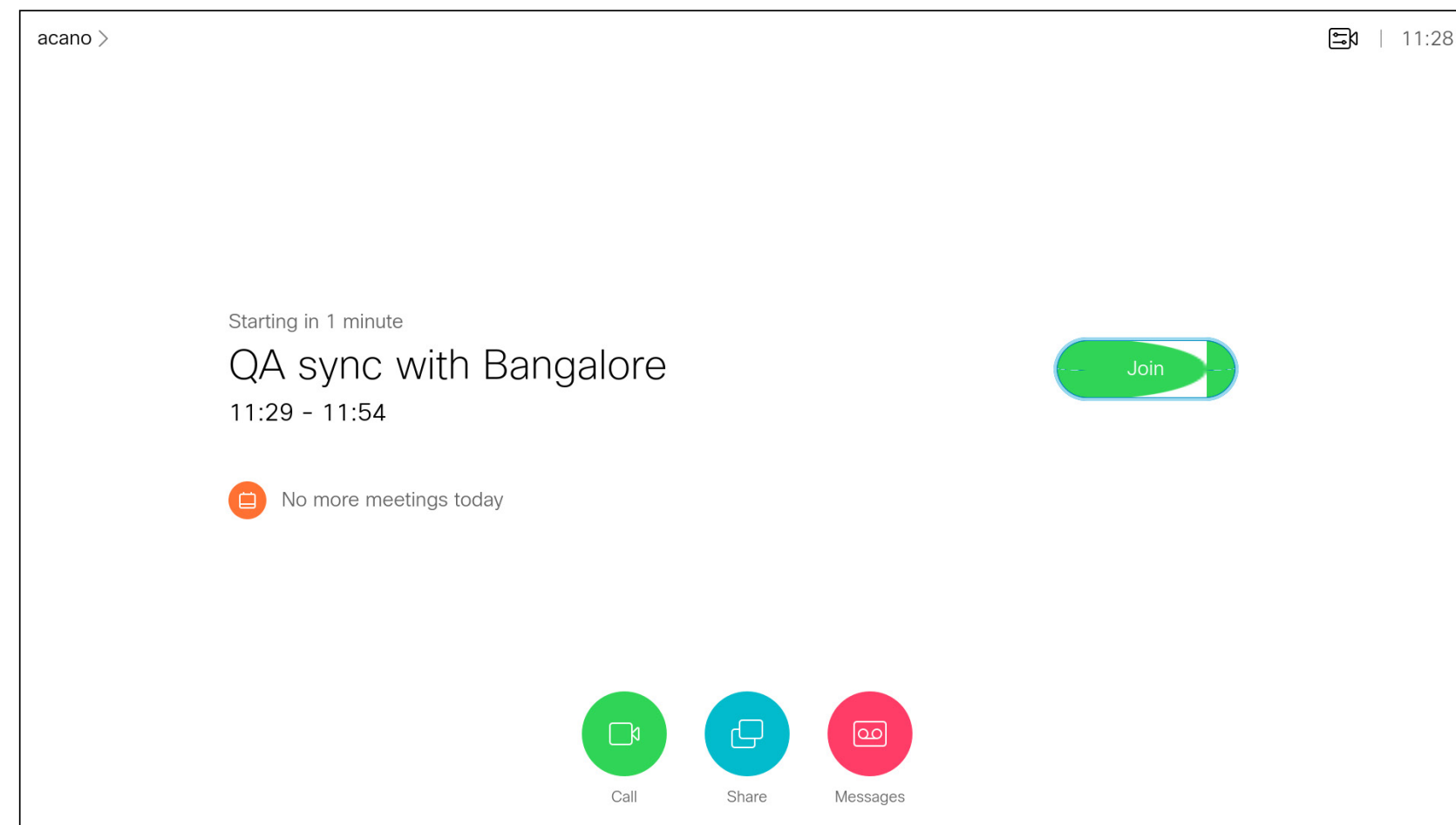

Joining a Meeting

Your video system may be connected to a management system capable of scheduling video meetings. Any meetings scheduled will then appear as shown at left.

Use *Join* to participate in the meeting.

Should the meeting have started already, you will still be offered to join.

There may be a *Snooze* icon available. Use this icon to postpone the offer to join for another 5 minutes.

Contacts

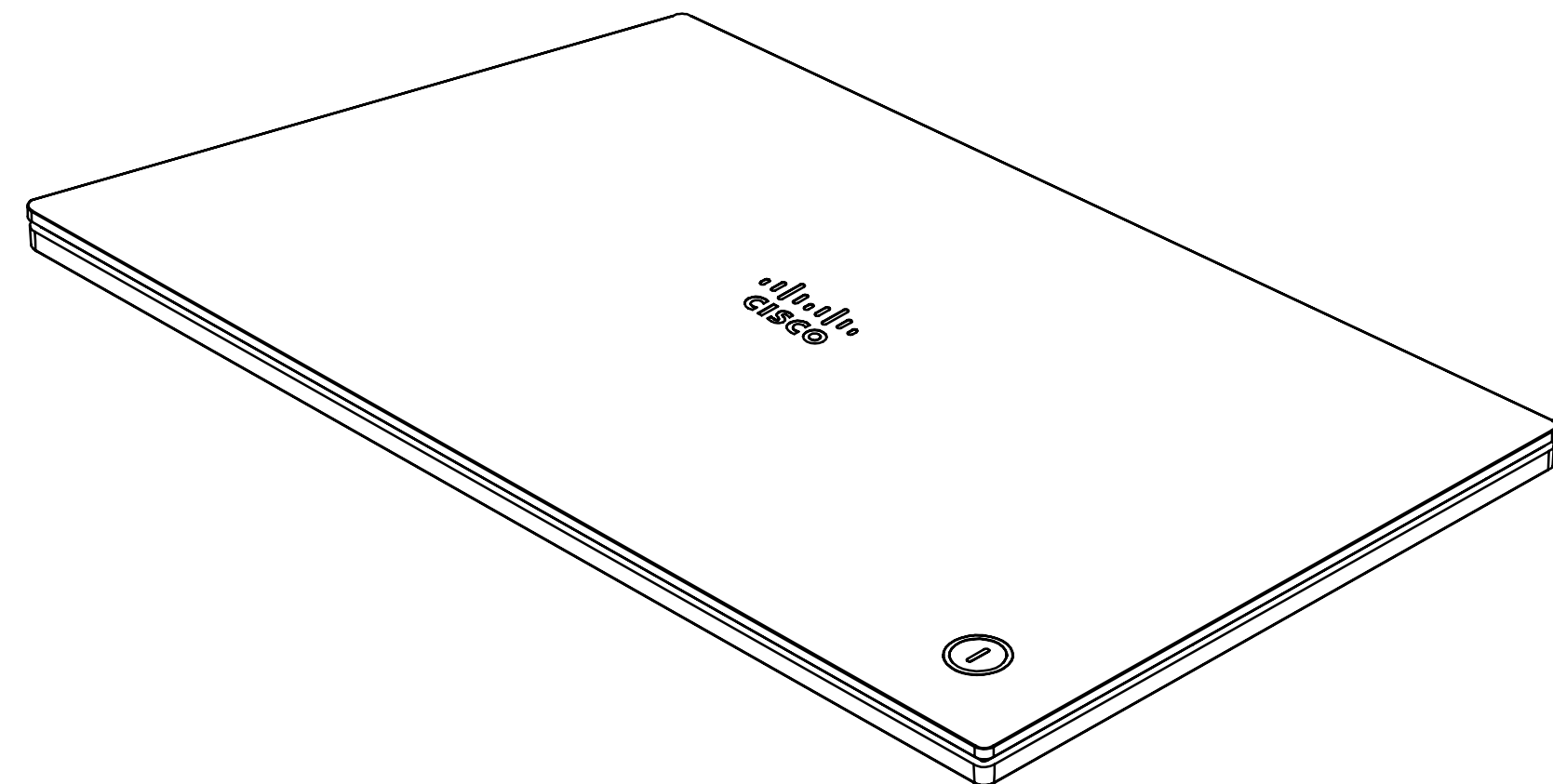
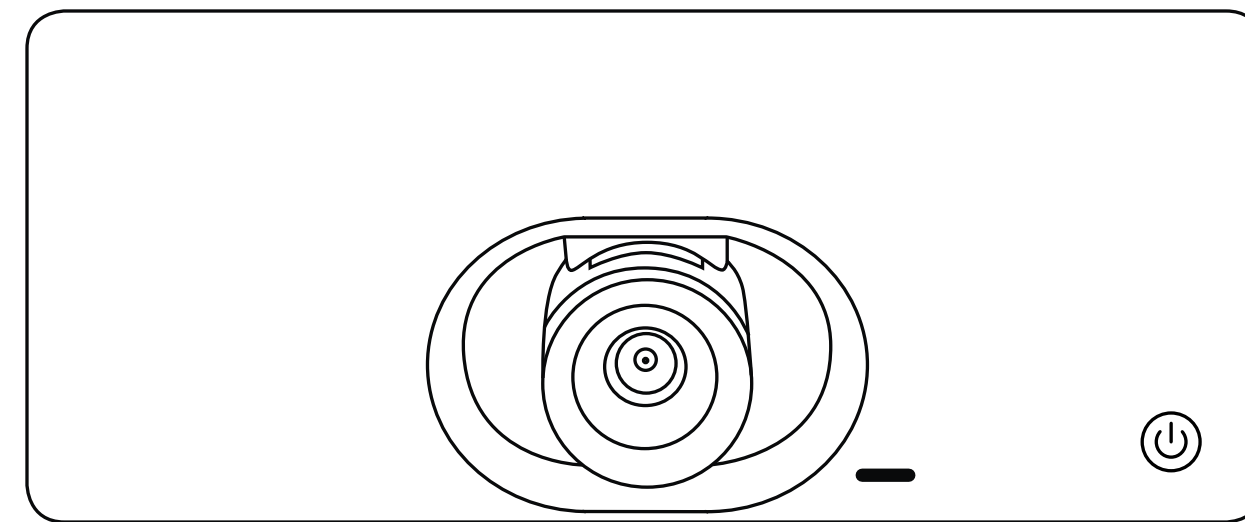

Add Someone to Favorites, Outside a Call

The *Directory* serves as your corporate phone book. This directory cannot be edited by you. You may, however, copy entries to your list of *Favorites* and edit them there.

Tap a folder to show its contents, scroll, if needed, to locate a folder or an entry within a folder.

When searching within the corporate *Directory*, the search will apply to the current directory folder and its subfolders only. To go one level up, tap **Back**. To make the search apply to the entire corporate directory, do not enter (tap) any folder before the search is commenced.

It may happen that an entry copied from the directory to the list of favorites later is updated in the directory. This update will not be reflected in your list of favorites—you must then manually update the entry in the list of favorites. Use **Edit and Call** for this.

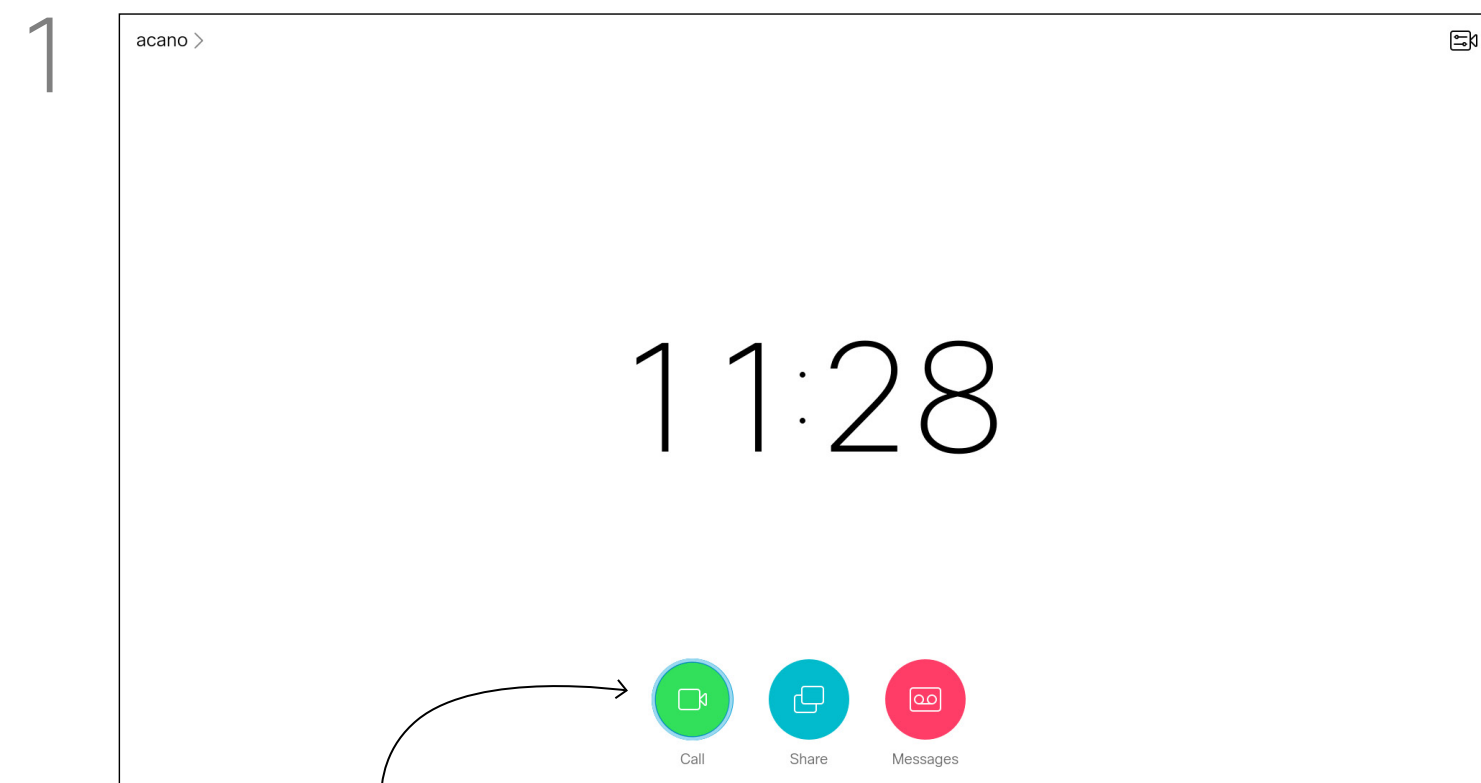

Make sure *Call* is selected (leftmost field along the bottom of the screen) and press **OK** or the green **Call** button on the remote control .

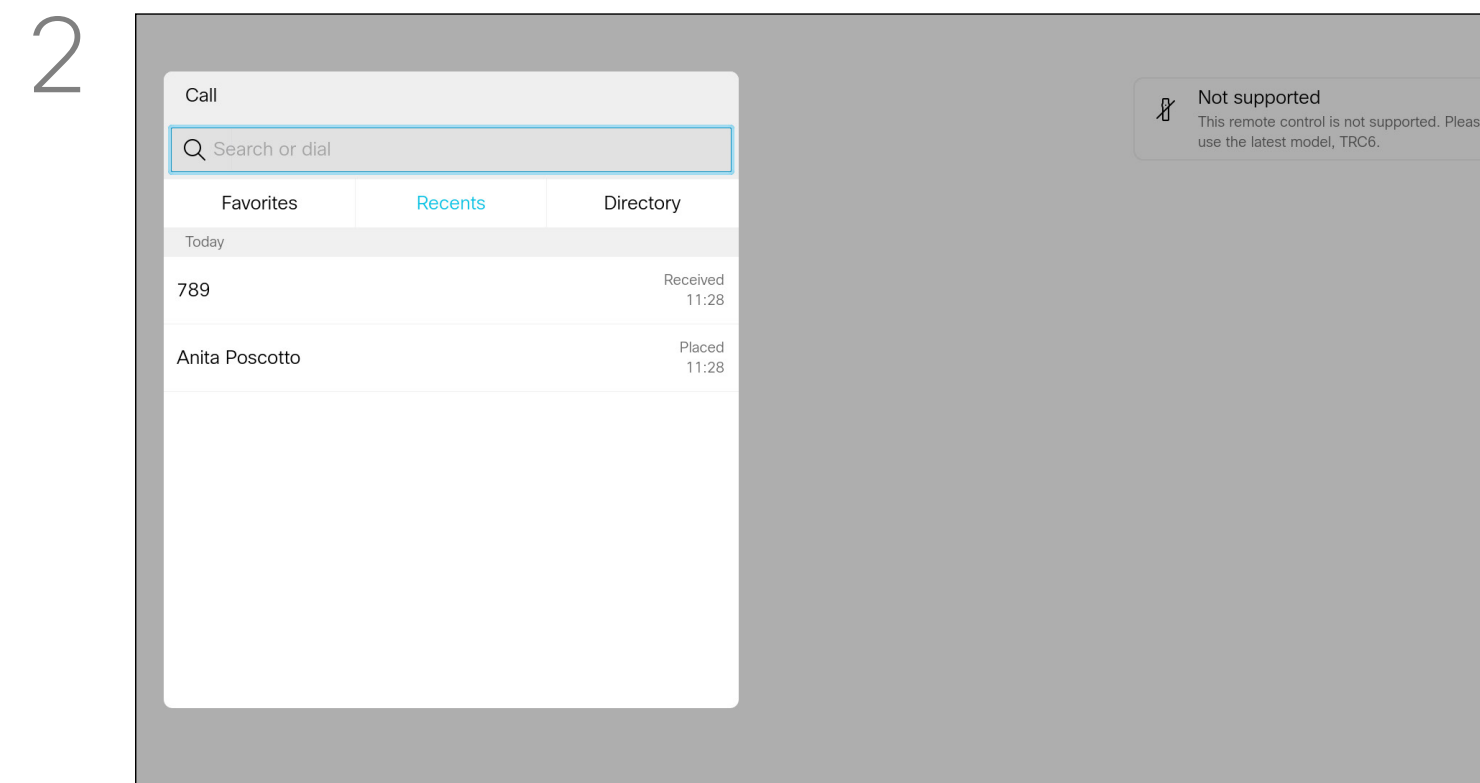

The *Call* menu will appear. Use the **Cursor** keys to navigate between *Recents* and *Directory* (the two rightmost) and then down in one of those lists.

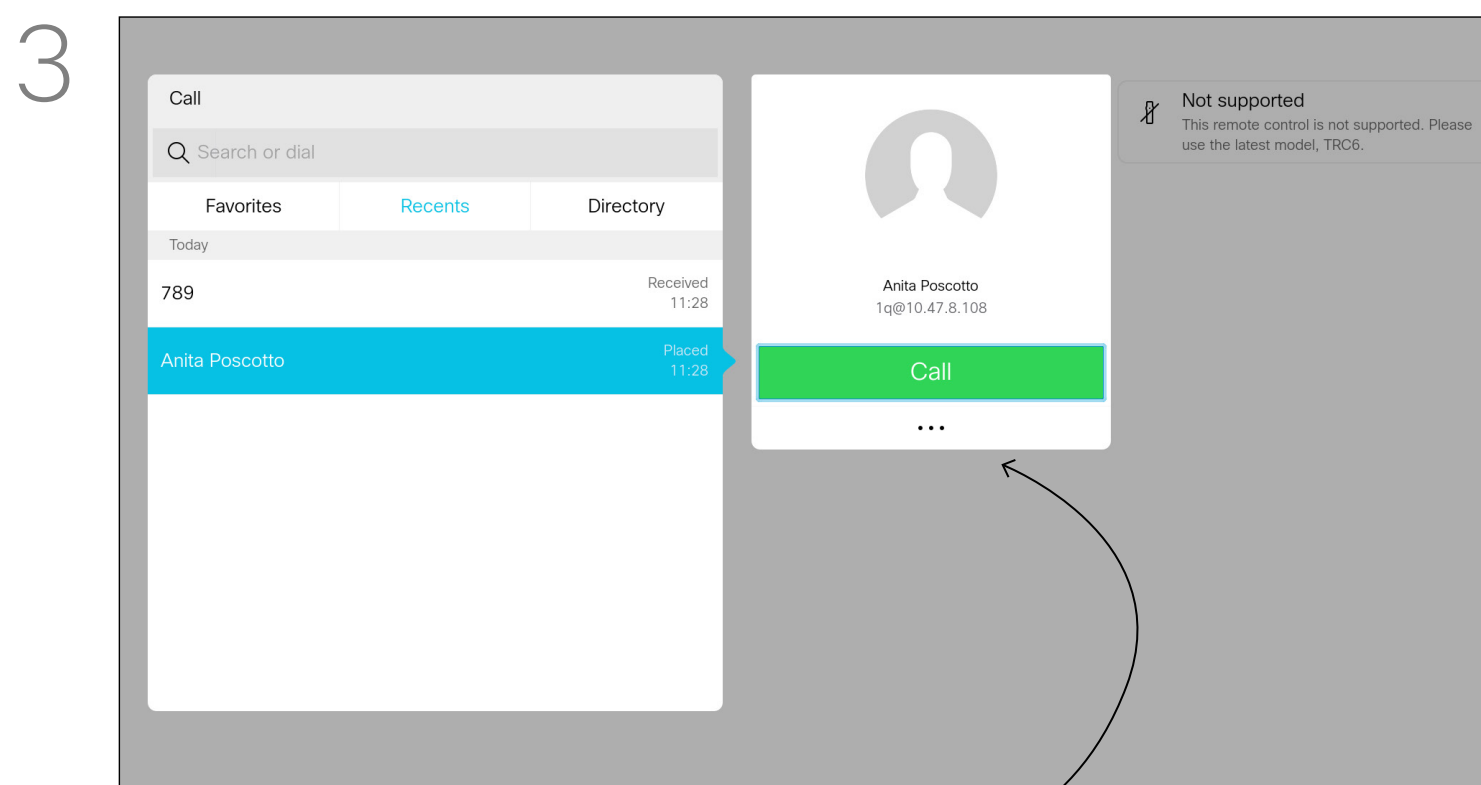

Once an entry has been located, press **OK** on the remote control to invoke the *Call* menu and use the **Cursor** keys to navigate to *More (...)* Press **OK**.

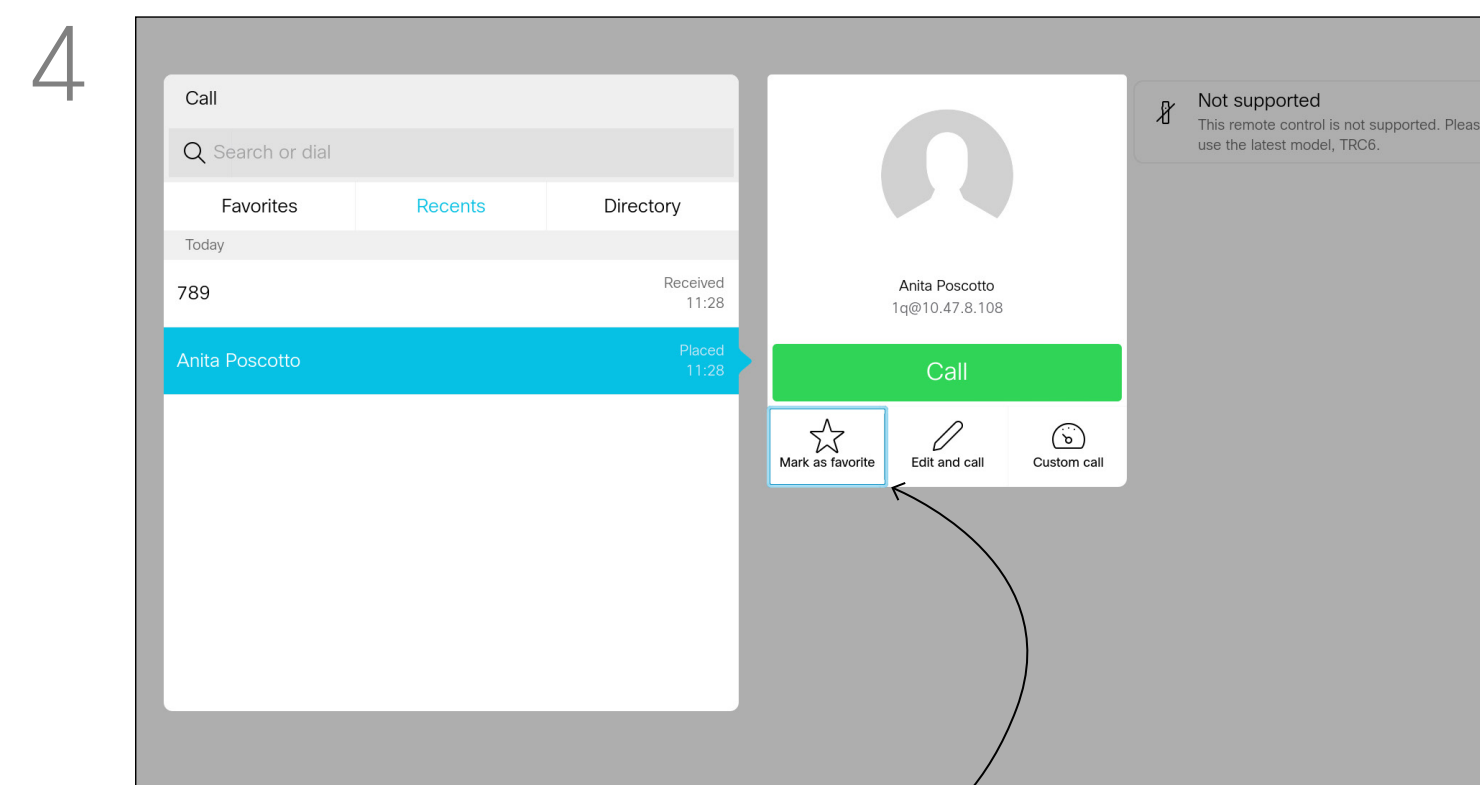

Then use the **Cursor** keys to navigate to *Mark as Favorite*. Press **OK** on the remote control to make the selected entry a favorite. Repeat this procedure to remove someone from the list of Favorites.

Add Someone to Favorites, While in a Call

About Favorites

1

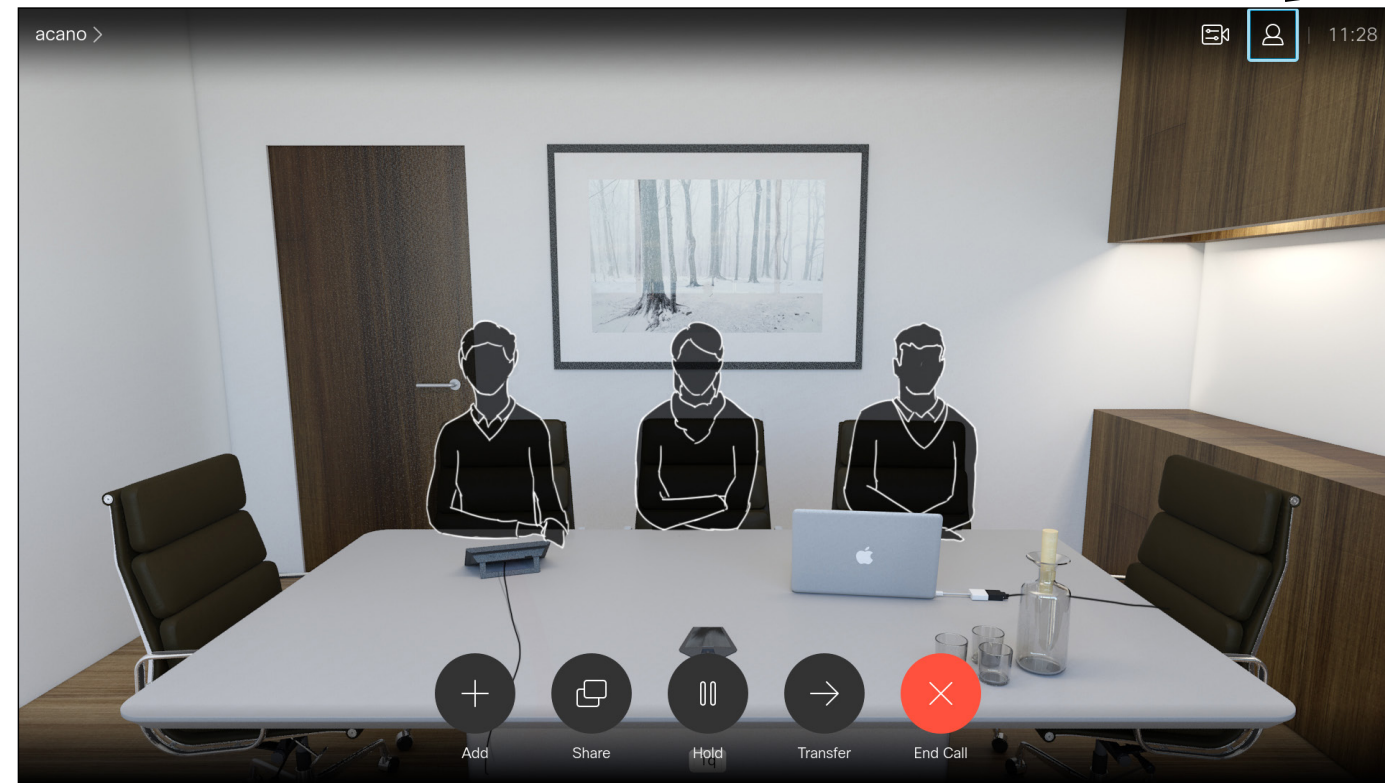

In a call, use the remote control to navigate to the *Participants* icon in the upper right corner, and press **OK** on the remote control.

2

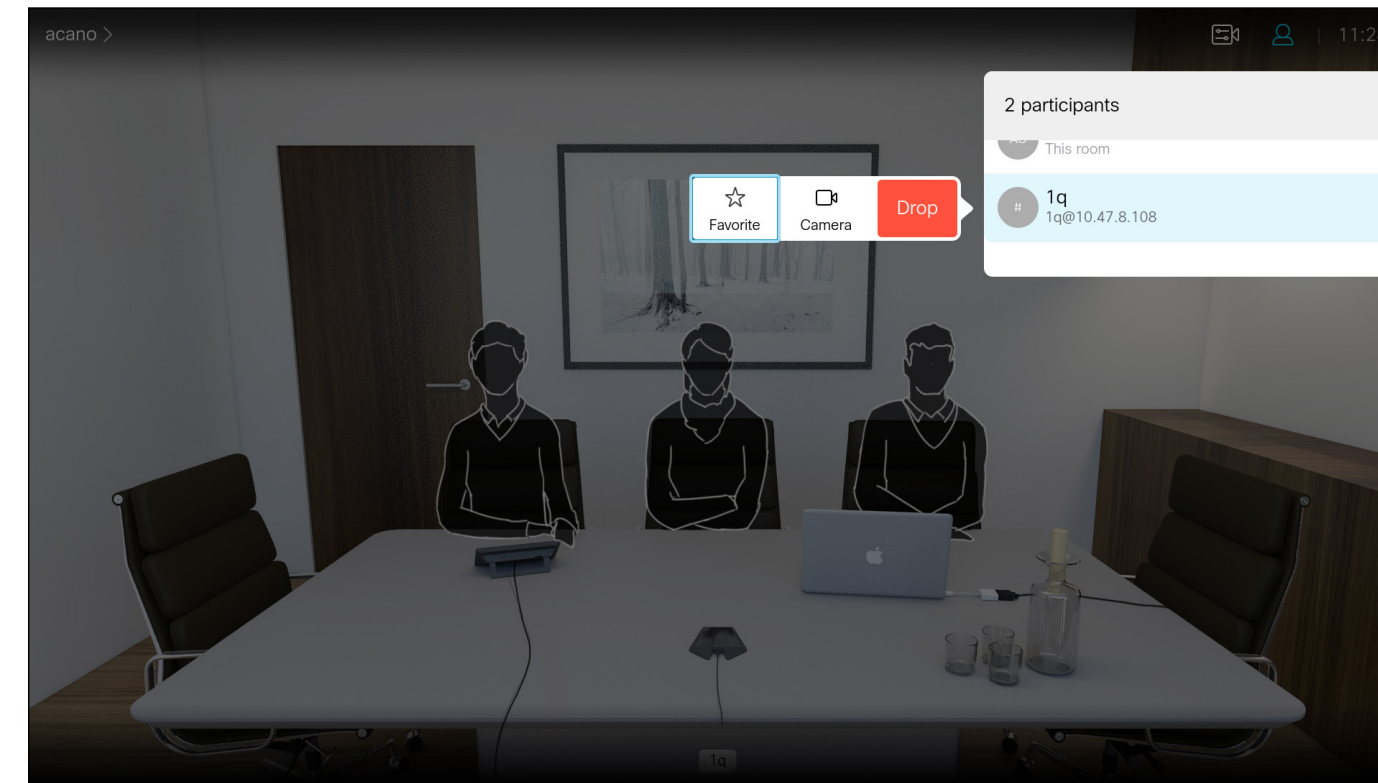

A menu showing a list of the participants in the call will now appear. Use the **Cursor** keys to navigate to the participant to become a favorite and press **OK** on the remote control. A submenu will appear.

3

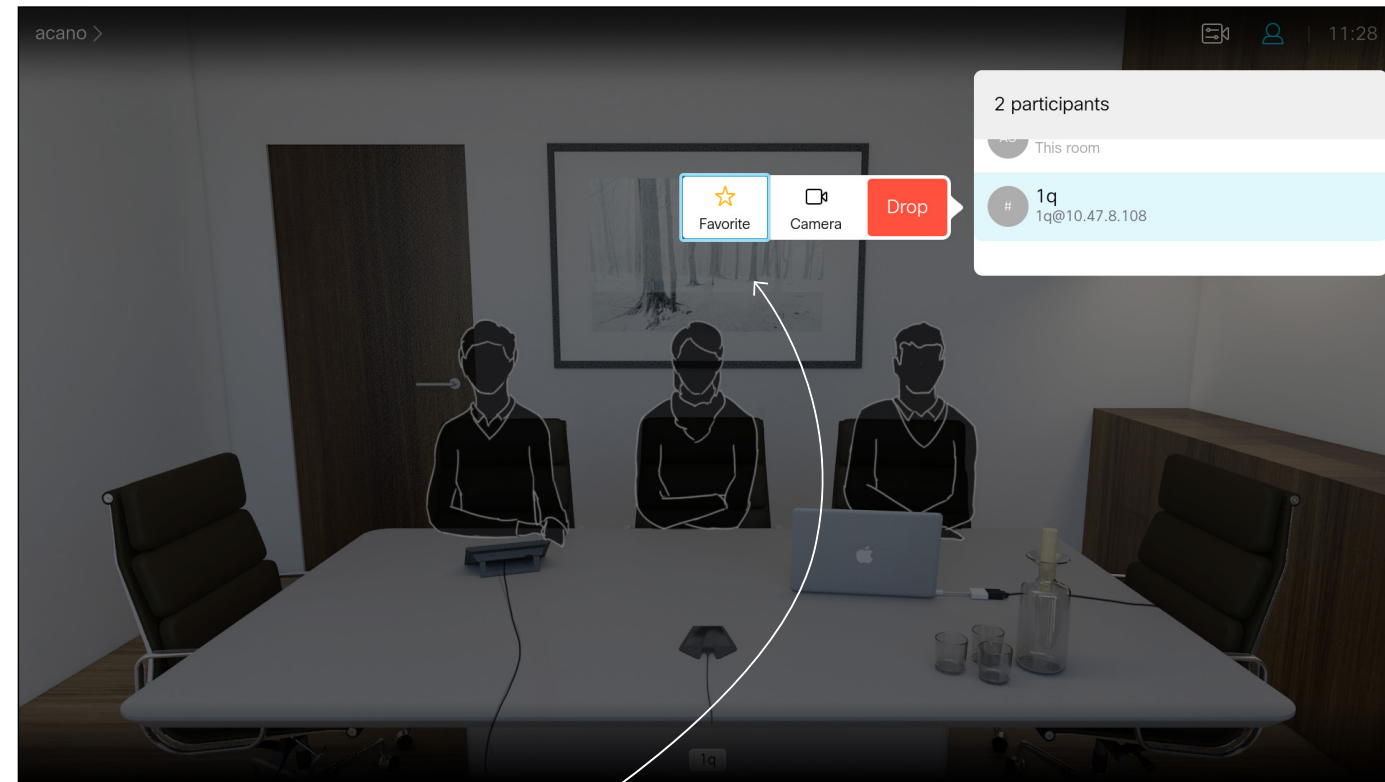

Then navigate to *Favorite* in this submenu (far left) and press **OK** on the remote control. The selected participant has now become a Favorite.

Repeat to undo.

Favorites is your own personal directory. Entries may come from the corporate directory (for more on this, see the previous page) or they may come from someone you call or someone who call you.

Camera Control

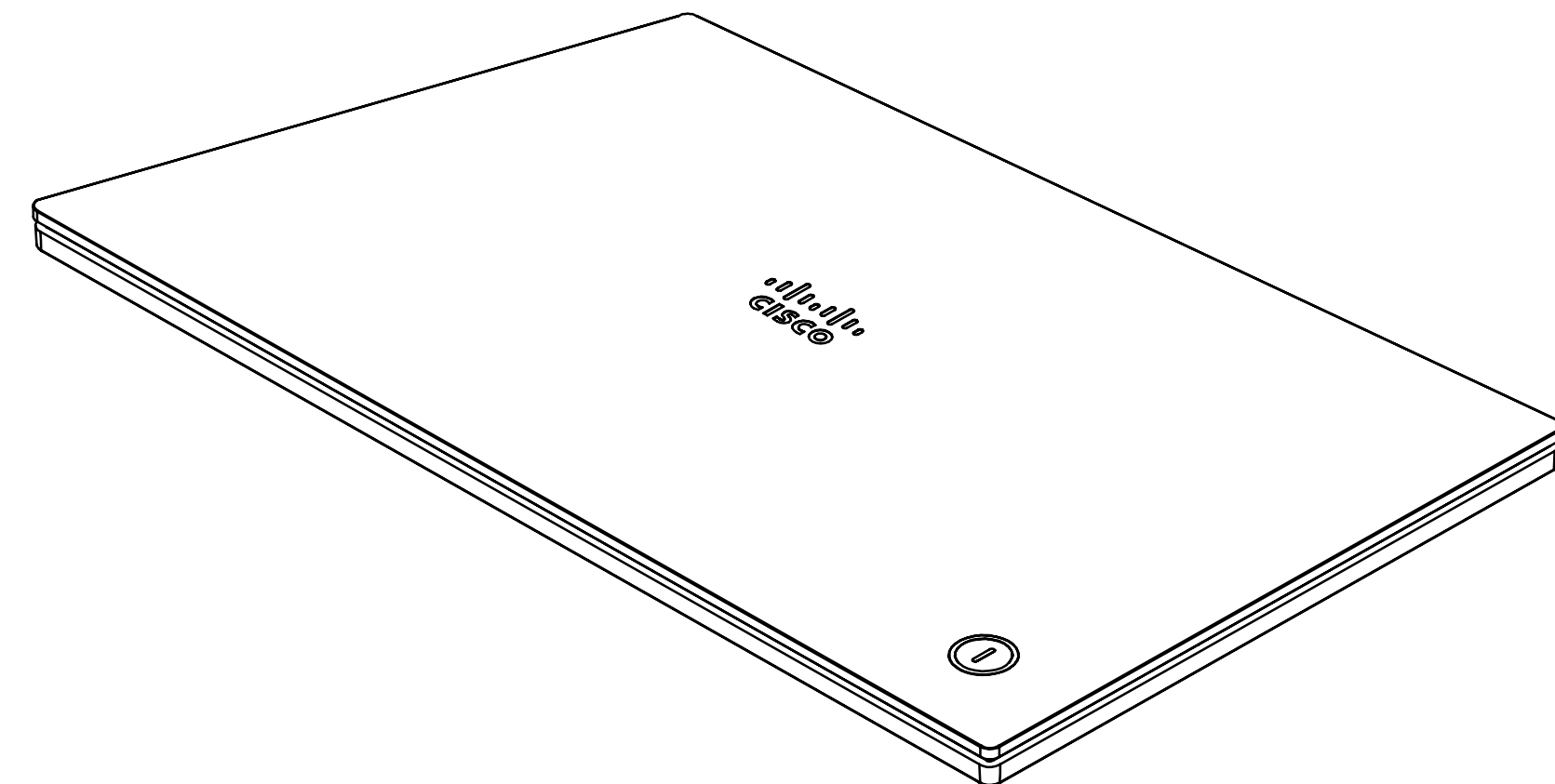

View Camera Settings (Local camera)

About Camera Settings

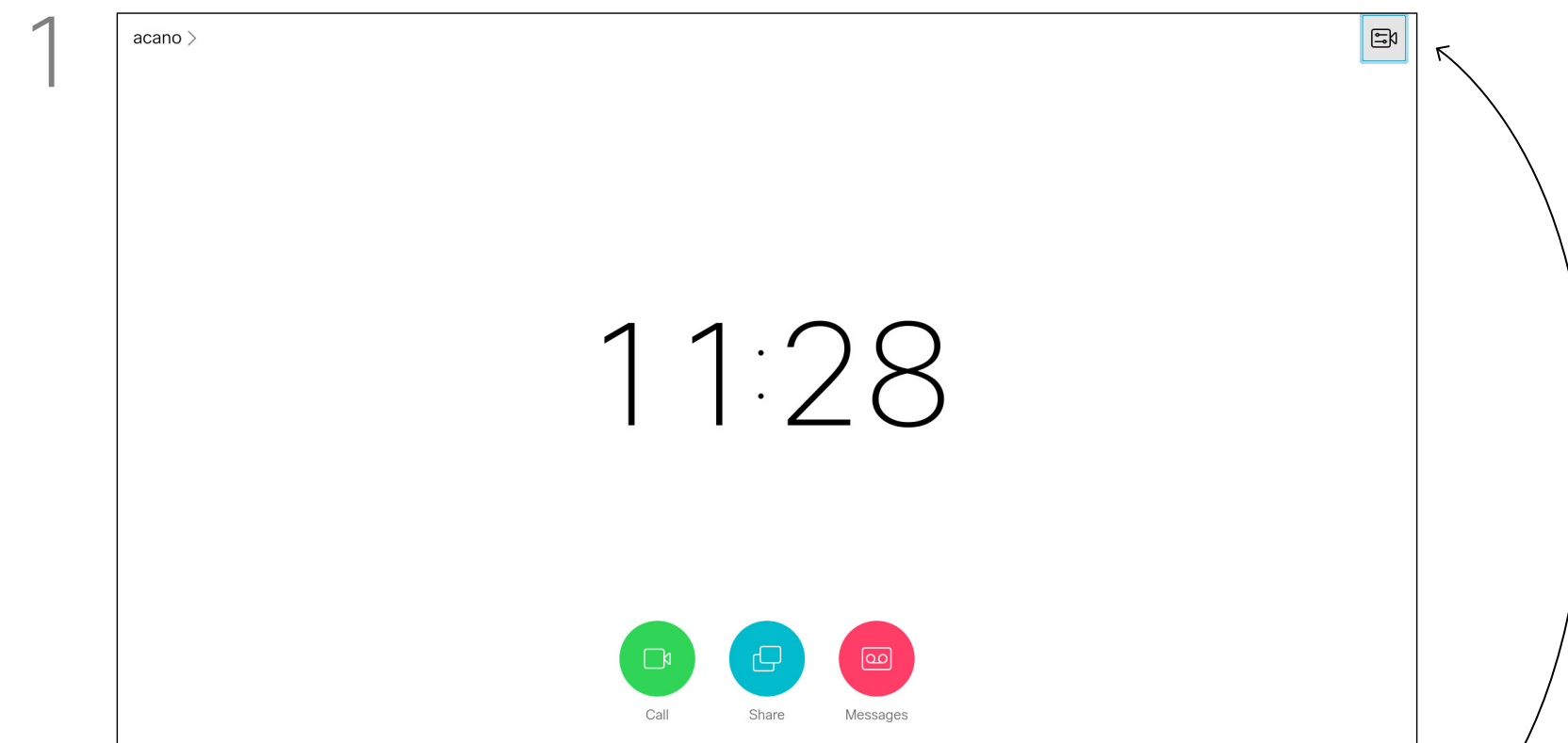

1 In a call or outside a call (as shown here), move cursor up to the upper right corner to the *Camera* icon. Press **OK** on the remote control.

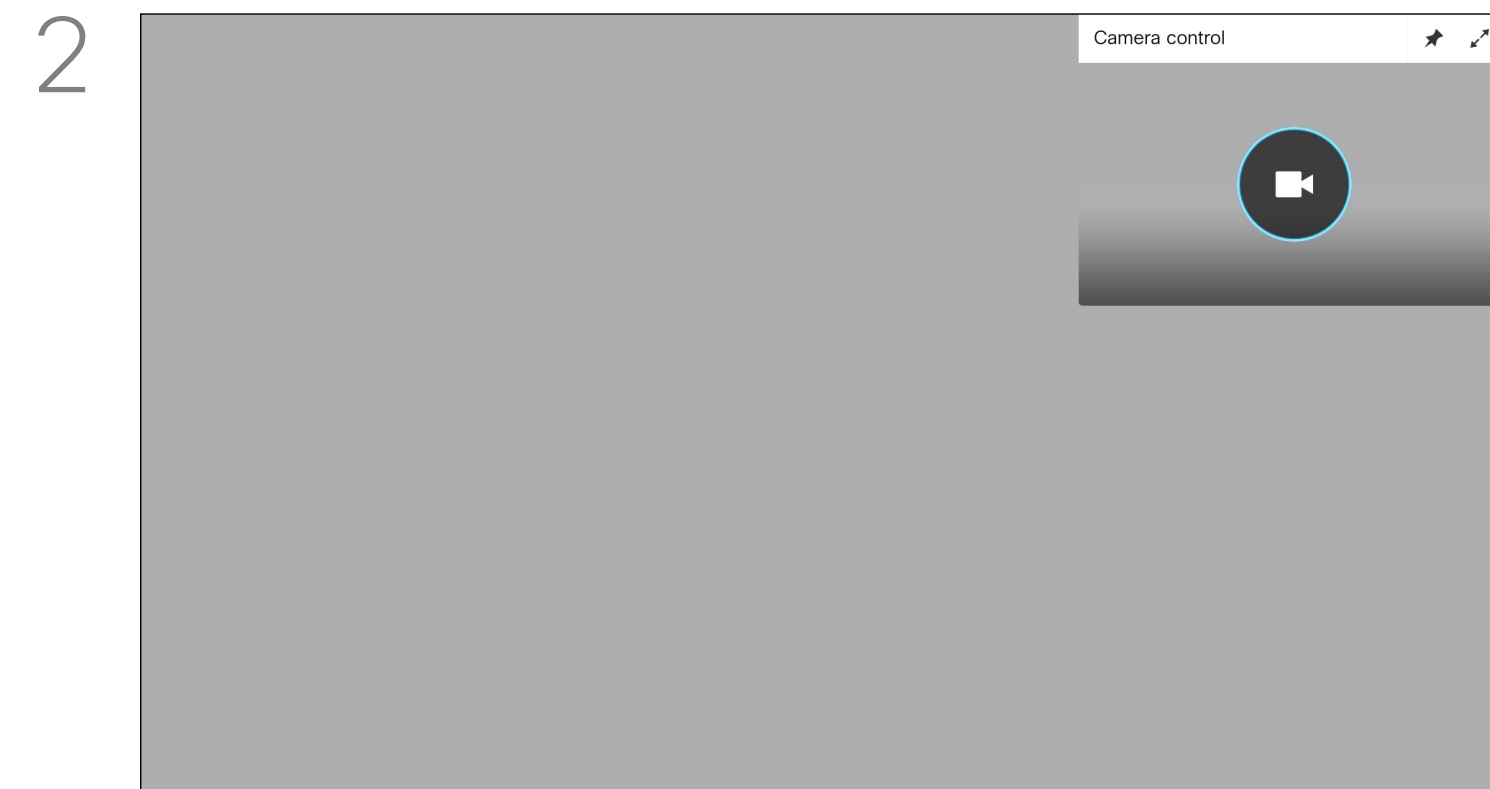

2 The camera icon will now appear. Press **OK** again on the remote control.



3 You may now make the adjust the pan, zoom and tilt of the camera. Use the **Increase/Decrease** controls of the remote control to adjust the zoom and the **Cursor** keys to adjust pan and tilt.

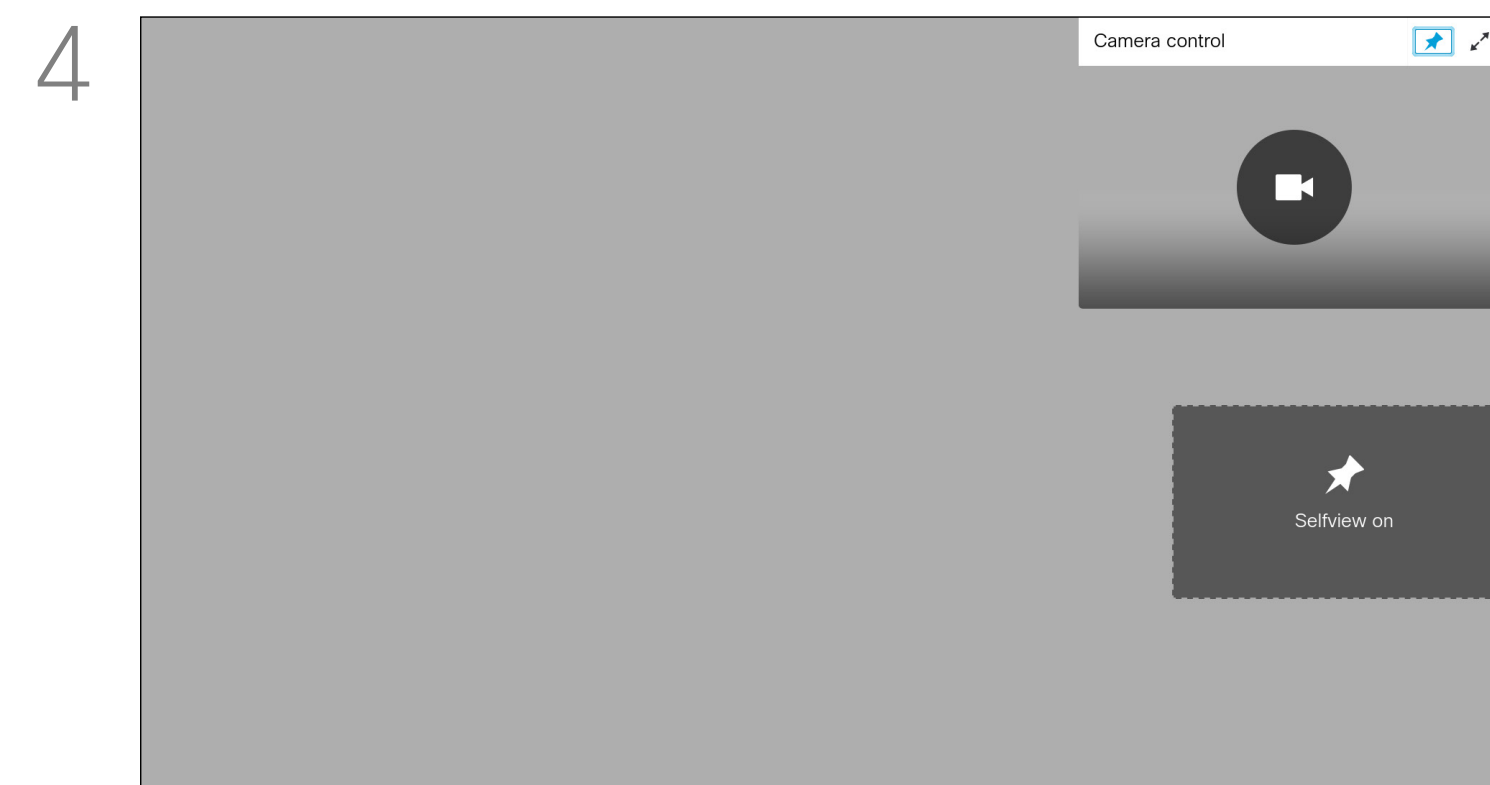

4 You may also make the self-view image sticky (always shown) and/or maximize it by selecting the icons in the upper right corner of this menu.

Press **Back** on the remote control to exit the menu.

The camera settings let you control the zoom, pan and tilt of your own camera.

The self-view (the image that the others see from your system) can be turned on and off as well as be shown minimized or maximized (full screen).

You may want the self-view to be always shown, this is called to make it *sticky*.

Far end Camera Control

About Far End Camera Control

1

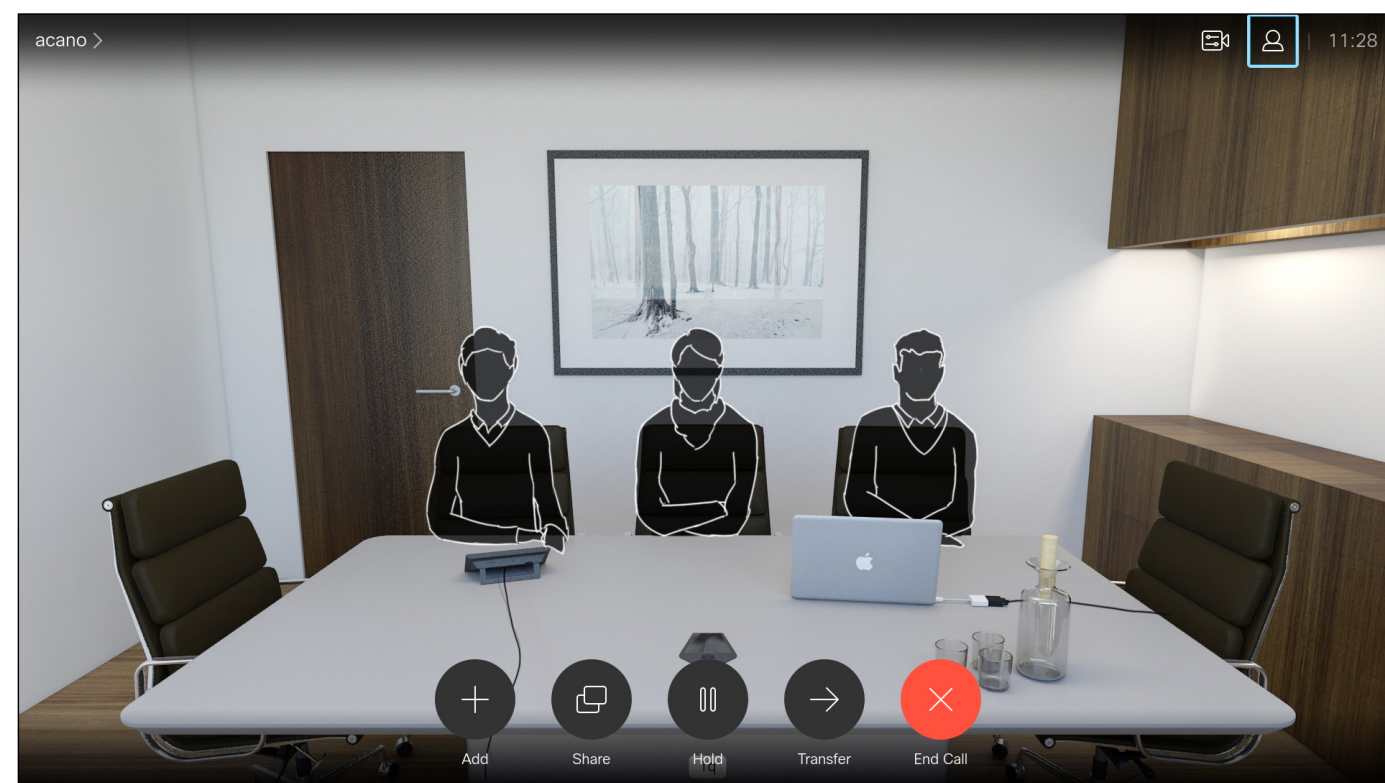

Navigate to *Participants* in the upper right corner and press **OK** on the remote control.

2

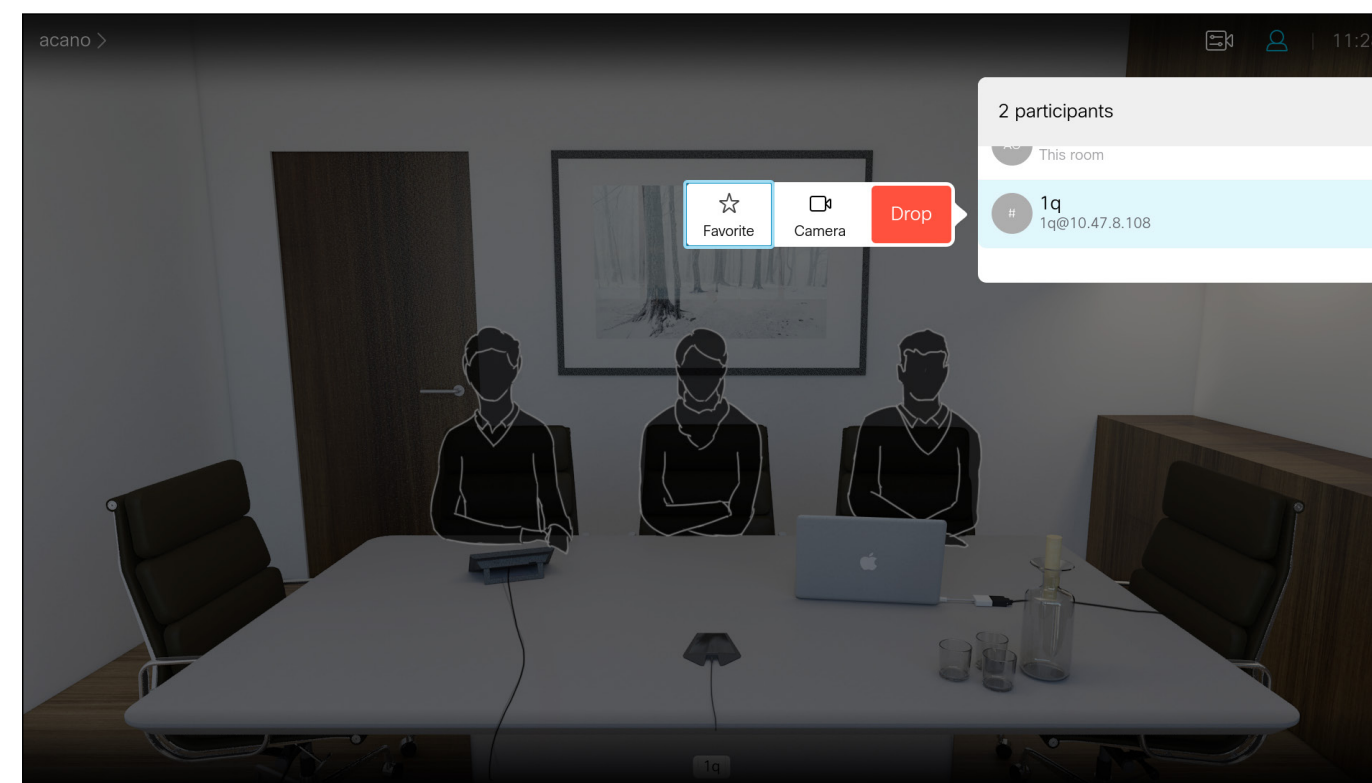

A menu showing a list of the participants in the call will now appear. Navigate to the participant, whose camera you want to control and press **OK** on the remote control. A submenu will now appear.

3

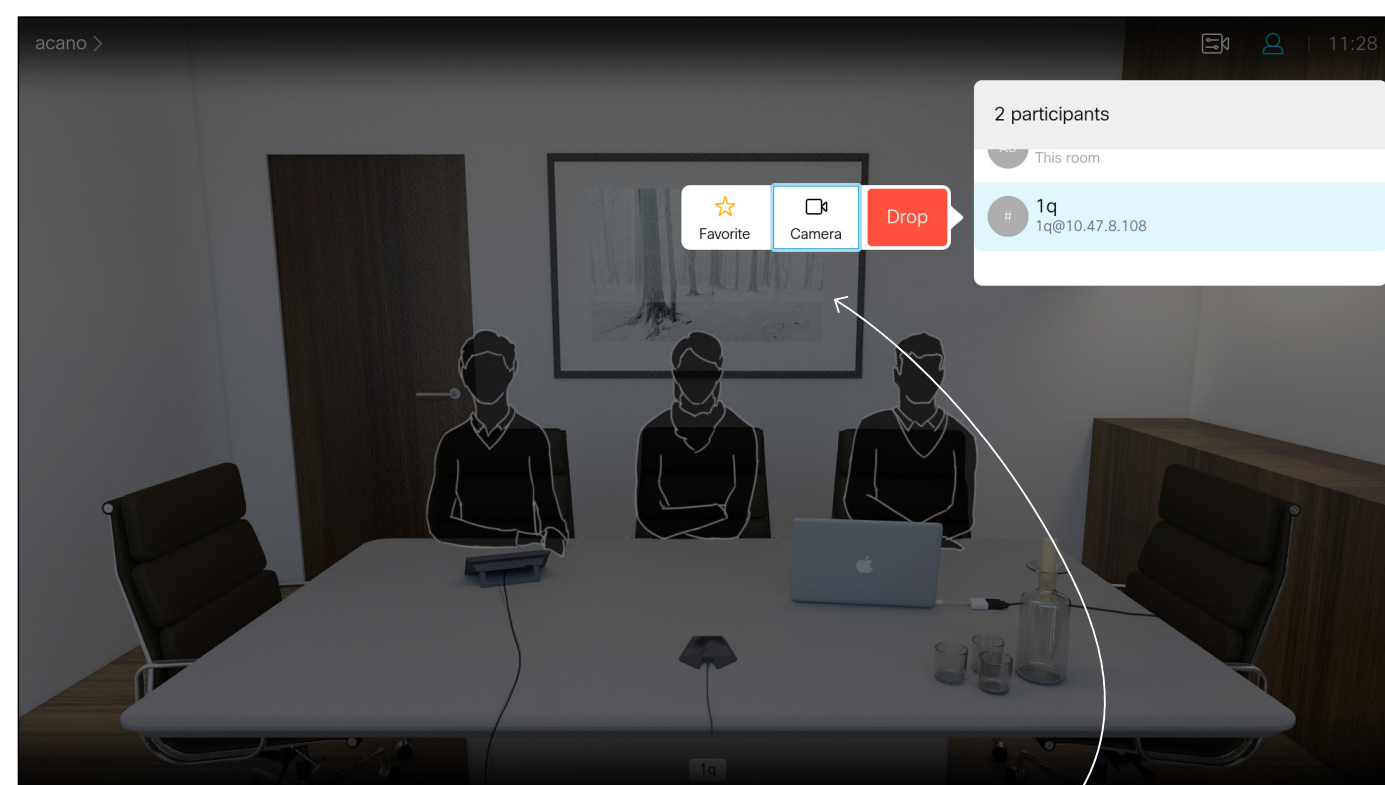

To control the far end camera navigate to *Camera* (number two from the right) and click **OK** on the remote control.

4

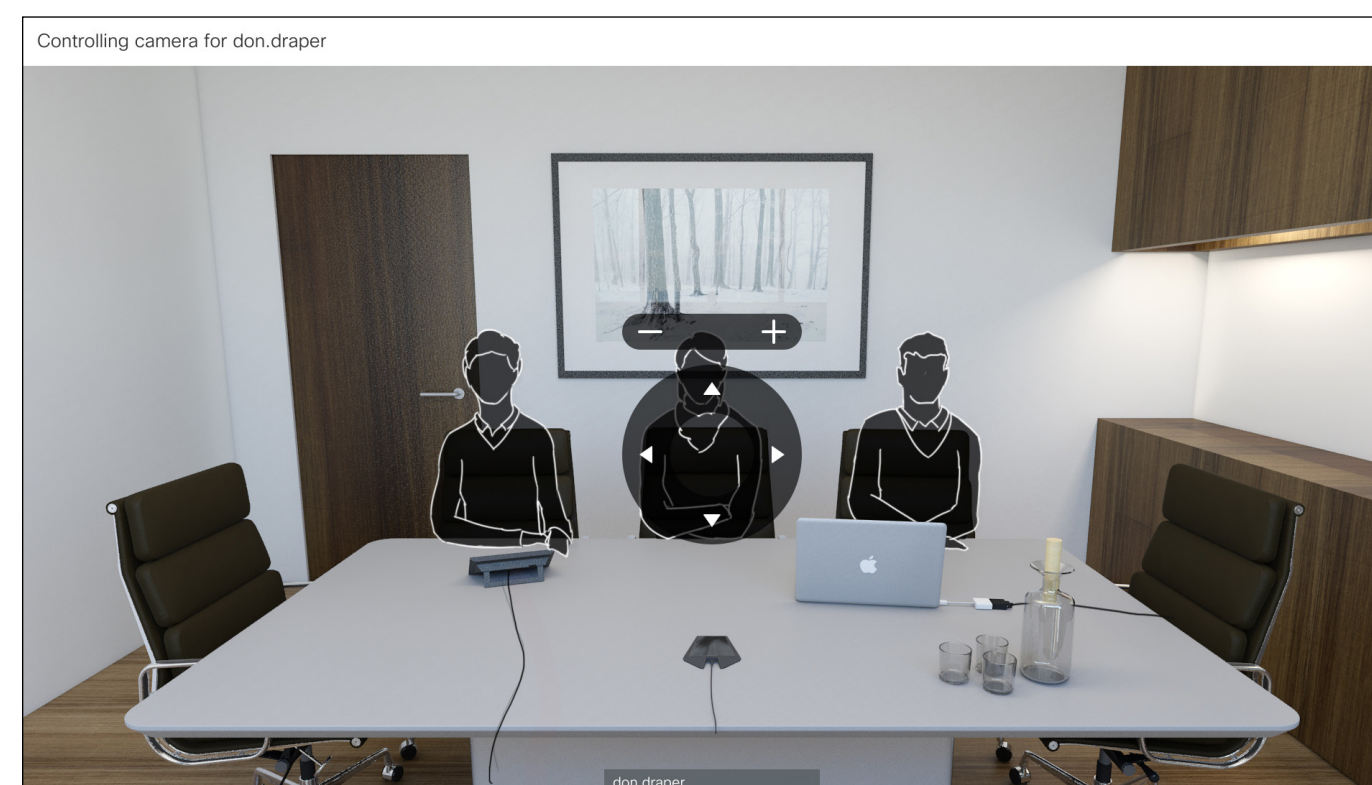

Adjust **Pan**, **Tilt** and **Zoom** as per your liking. Use **OK** or **Back** on the remote control to exit.

Many video systems have a remotely controllable camera. Such systems allow you to use a remote control to change pan, tilt, and zoom.

If the far end (those you are in a meeting with) have such a system, you may be able to control their camera during the call.

Move the Selfview PiP

Why Move the Selfview?

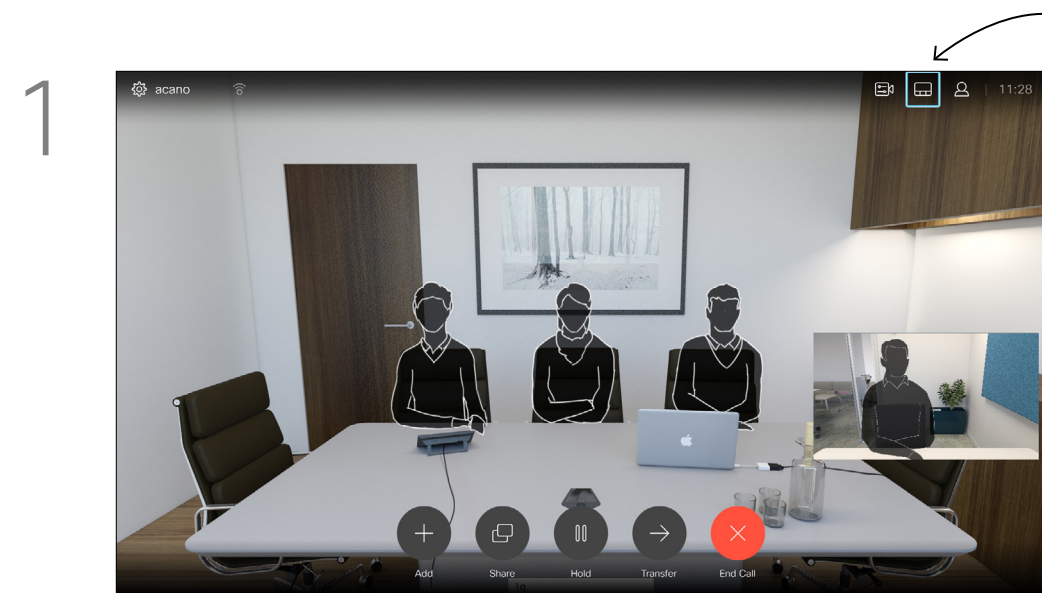

With self-view activated or a layout involving a picture-in-picture, navigate to *Layout* in the upper right corner and press **OK** on the remote control. The Layout icon will appear only when relevant.

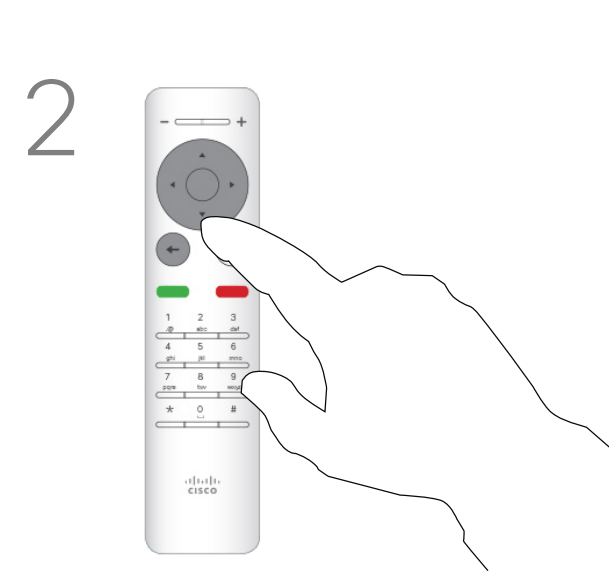

The layout menu will now appear. Press the down **Arrow** of the **Cursor** keys on the remote control to navigate to the self-view image.

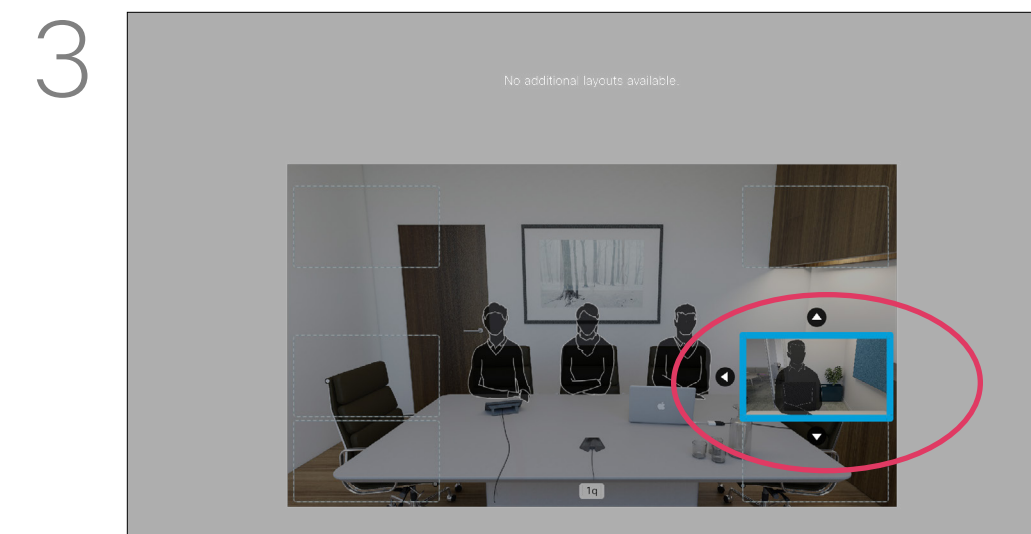

The self-view image will now turn blue to show that it has been selected. Click **OK** on the remote control. Arrows will now appear to indicate that the self-view image can be moved. Possible new locations are indicated.

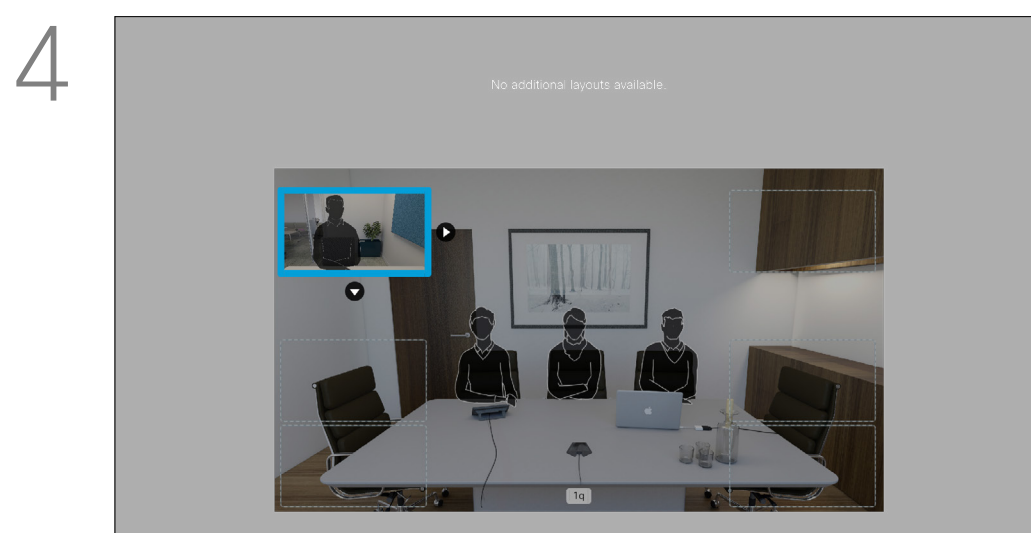

Use the **Cursor** keys on the remote control to move the image. Press **OK** when finished.

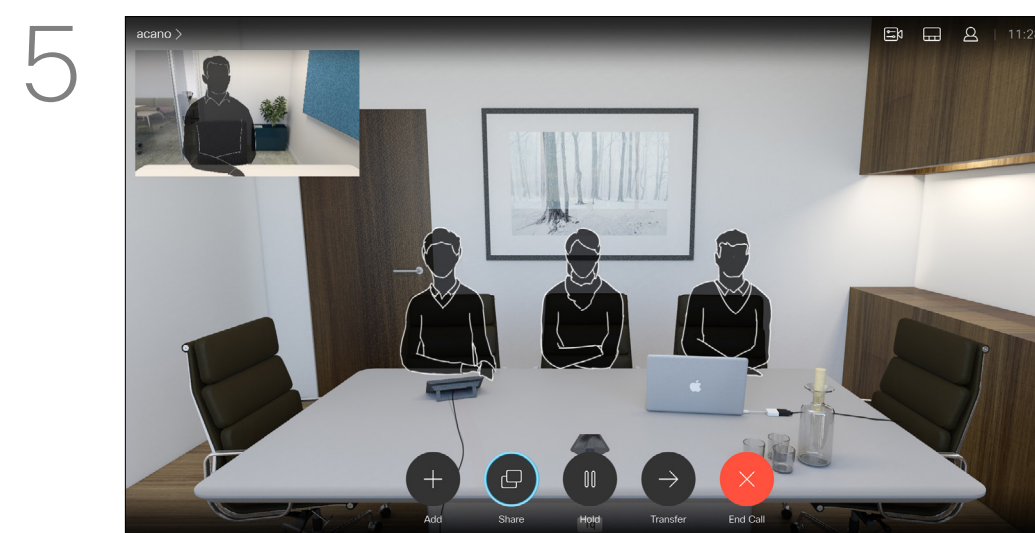

The image on the screen will then assume its original size with the selfview in its new position.

Selfview shows what others see from your video system. You will normally use it to confirm that they see what you want them to see. The selfview appears as a PiP (Picture-in-Picture). From time to time you may want to have the selfview activated during the meeting. This could, for example, be to ensure that you remain seen on the screen. It may happen that the current position of the selfview blocks important parts of the image on your screen. You may therefore want to move it.

Settings

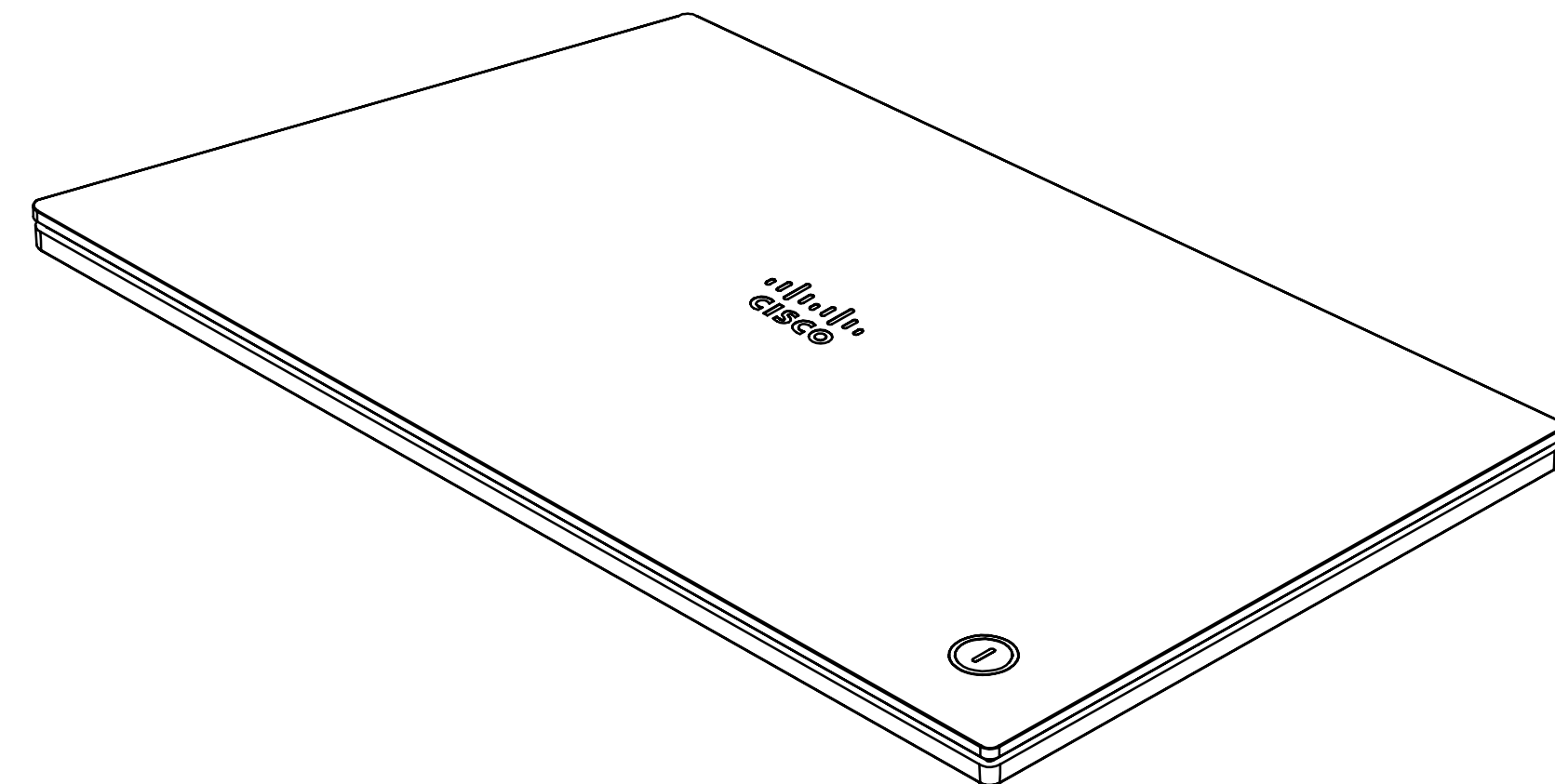
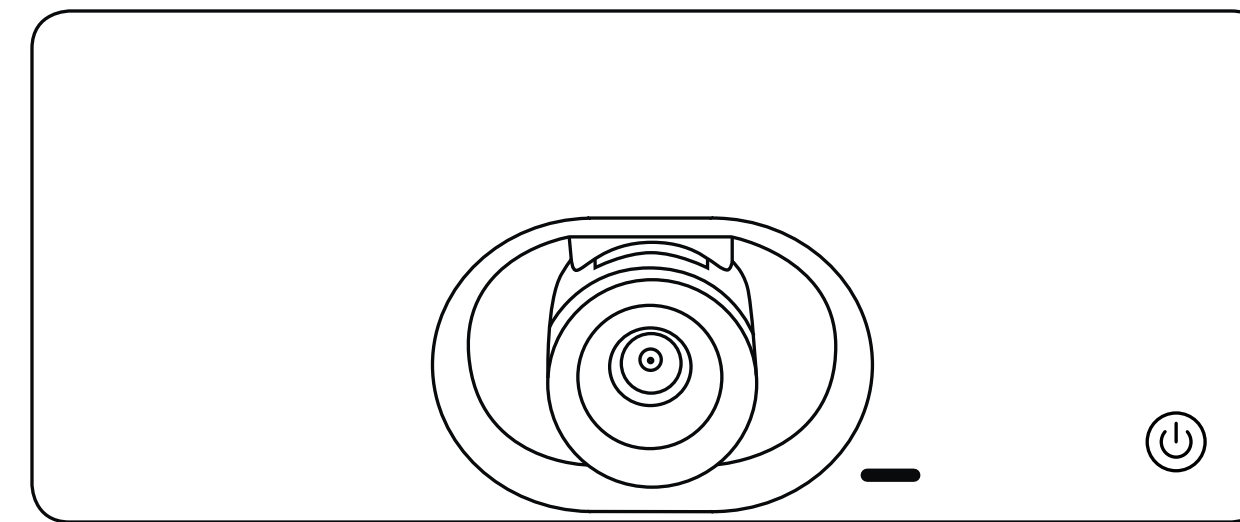

Gain Access to the Settings

About Settings

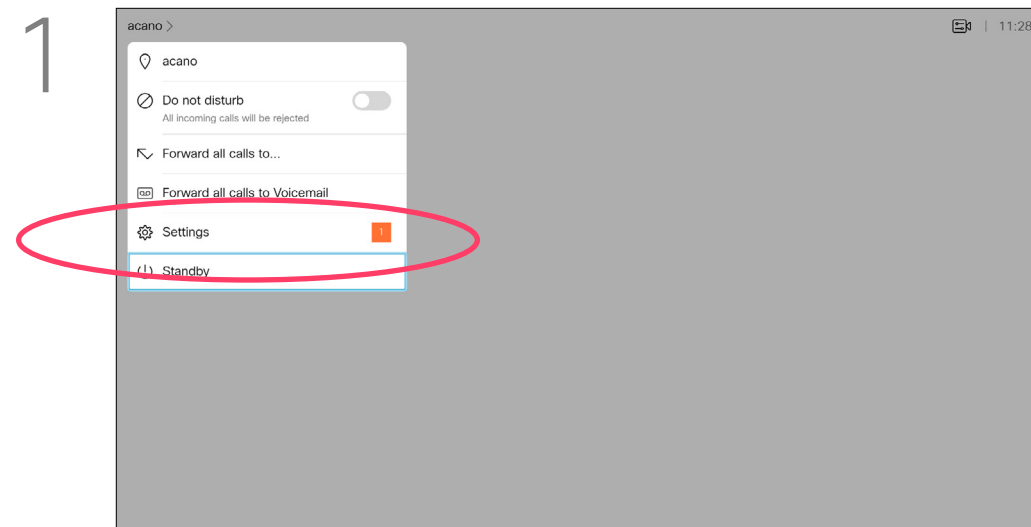

1 To gain access to the *Settings* menu, navigate to the upper left corner of the screen and press **OK** on the remote control. Then navigate down to *System Information* (number two from the bottom of the menu) and press **OK** again.

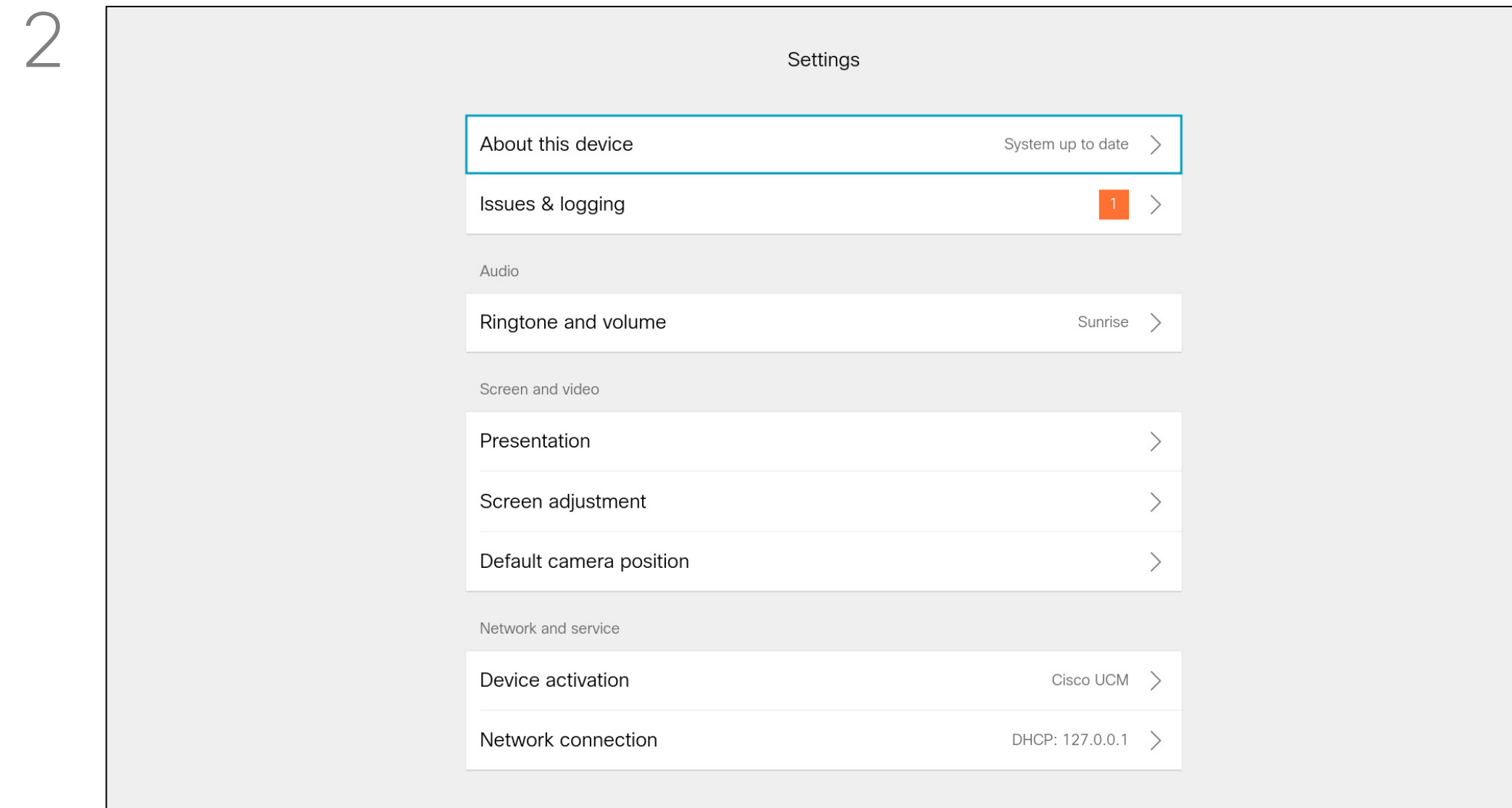

2 The *Settings* shows basic information about the system as well as providing access to the Setup Wizard and the ability to force a restart of the system.

The System information page provides information on IP address, MAC address, SIP Proxy, software version installed and device name. The system can be restarted from here and setup wizard is available via *Advanced settings*. You may now specify ringtone and volume from this menu.



Americas Headquarters
Cisco Systems, Inc.
San Jose, CA

Asia Pacific Headquarters
Cisco Systems (USA) Pte. Ltd.
Singapore

Europe Headquarters
Cisco Systems International BV Amsterdam,
The Netherlands

Cisco has more than 200 offices worldwide. Addresses, phone numbers, and fax numbers are listed on the Cisco Website at www.cisco.com/go/offices.

Cisco and the Cisco Logo are trademarks of Cisco Systems, Inc. and/or its affiliates in the U.S. and other countries. A listing of Cisco's trademarks can be found at www.cisco.com/go/trademarks. Third party trademarks mentioned are the property of their respective owners. The use of the word partner does not imply a partnership relationship between Cisco and any other company. (1005R)