



Cisco Prisma II 1.2 GHz High Density Long Reach Multiwave (HD-LRMW) and Hybrid Modulation QAM (HQT) Transmitters







Installation and Operation Guide

For Your Safety

Explanation of Warning and Caution Icons

Avoid personal injury and product damage! Do not proceed beyond any symbol until you fully understand the indicated conditions.

The following warning and caution icons alert you to important information about the safe operation of this product:

-  You may find this symbol in the document that accompanies this product. This symbol indicates important operating or maintenance instructions.
-  You may find this symbol affixed to the product. This symbol indicates a live terminal where a dangerous voltage may be present; the tip of the flash points to the terminal device.
-  You may find this symbol affixed to the product. This symbol indicates a protective ground terminal.
-  You may find this symbol affixed to the product. This symbol indicates a chassis terminal (normally used for equipotential bonding).
-  You may find this symbol affixed to the product. This symbol warns of a potentially hot surface.
-  You may find this symbol affixed to the product and in this document. This symbol indicates an infrared laser that transmits intensity-modulated light and emits invisible laser radiation or an LED that transmits intensity-modulated light.

Important

Please read this entire guide. If this guide provides installation or operation instructions, give particular attention to all safety statements included in this guide.

Notices

Trademark Acknowledgments

Cisco and the Cisco logo are trademarks or registered trademarks of Cisco and/or its affiliates in the U.S. and other countries. For a list of Cisco trademarks, go to this URL: www.cisco.com/go/trademarks.

Third party trademarks mentioned are the property of their respective owners.

The use of the word partner does not imply a partnership relationship between Cisco and any other company. (1110R)

Publication Disclaimer

Cisco Systems, Inc. assumes no responsibility for errors or omissions that may appear in this publication. We reserve the right to change this publication at any time without notice. This document is not to be construed as conferring by implication, estoppel, or otherwise any license or right under any copyright or patent, whether or not the use of any information in this document employs an invention claimed in any existing or later issued patent.

Copyright

© 2018 Cisco and/or its affiliates. All rights reserved. Printed in the United States of America.

Information in this publication is subject to change without notice. No part of this publication may be reproduced or transmitted in any form, by photocopy, microfilm, xerography, or any other means, or incorporated into any information retrieval system, electronic or mechanical, for any purpose, without the express permission of Cisco Systems, Inc.

Contents

Important Safety Instructions	vii
Laser Safety	xix
Laser Power and Warning Labels - Half Height Module	xxi
Introduction	1
Description	3
Features	3
Operation	3
Optical Output.....	4
Transmitter Block Diagram	4
High Density Transmitter Front and Back Panel.....	6
High Density Transmitter Illustration	6
High Density Transmitter Front Panel Features	7
Back Panel Connectors	8
Host Module.....	9
Host Module Features.....	9
Host Module Illustration	9
Host Module Back Panel Connectors.....	10
Module Configuration.....	11
Configuration and Monitoring Methods.....	11
Configuration Summary	11
Module Installation	13
Preparing for Installation	14
Unpacking and Inspecting the Module	14
Equipment and Tools Needed.....	14
Site Requirements	15
Access Requirements.....	15
Equipment Rack	15
Operating Environment.....	15
Power Requirements	16
Space Requirements	16
Standard Prisma II Chassis	16
Prisma II XD Chassis Style.....	18
Connecting the RF Cables to the Chassis	19
To Connect RF Cables for Each Module	19

Contents

Installing the HD Module in the Chassis	21
To Install the Transmitter Modules in the Host Module.....	21
To Install the Host Module in the Chassis.....	22
To Install the Module in a Prisma II XD Chassis	23
Routing Optical Cables.....	26
Fiber Fish Tool	26
The Fiber Fish Tool Hook	26
To Pull the Optical Cable to the Module	26
Cleaning Optical Connectors	28
Recommended Equipment	28
Tips for Optimal Fiber Optic Connector Performance	28
To Clean Optical Connectors.....	29
Connecting Optical Cables	30
To Connect Optical Cables to an HD Module.....	30
Connecting the ICIM to Additional Chassis.....	31
Chassis-to-Chassis ICIM Connections	31
ICIM IN and ICIM OUT Connectors.....	31
ICIM IN and ICIM OUT Cables	31
To Connect Chassis-to-Chassis ICIM IN and ICIM OUT Ports	32
External Alarm Connections	33
Master/Slave Operation	33
ALARMS IN and ALARMS OUT Connectors	33
ALARMS IN and ALARMS OUT Connector Illustration	34
Master/Slave Illustration.....	34
Redundancy Interface Panel.....	35
Prisma II Redundancy Interface Panel Illustrations	35
Operation Using the ICIM	37
ICIM Introduction.....	38
Laser Warning	38
ICIM Function.....	38
ICIM Block Diagram.....	39
ICIM2 Front Panel.....	40
ICIM2 Illustration (Front Panel).....	40
ICIM2 Front Panel Features	41
ICIM LCD.....	41
ICIM MAIN Menu Illustration	41
ICIM Keypad	42
ICIM Password.....	43
Password Protection System.....	43
To Access the Password Menu	43
Expired Password or Inactive Password Messages	44
To Enter the User Password	44
To Change the User Password	45
To Disable the User Password using ICIM.....	46

Operating the ICIM.....	48
Using the ICIM	48
To Access the ICIM LCD Contrast	48
ICIM MAIN Menu.....	48
ICIM MAIN Menu Illustration.....	48
Prisma II ICIM Menu	49
Prisma II MAIN Menu and ICIM Menu Structure	50
Prisma II High Density Long Reach Multiwave Transmitter Software Menus.....	50
Checking the Operating Status using the ICIM.....	51
To Check the Operating Status using ICIM.....	51
STATUS Menus	51
Configuring the Module using the ICIM	53
To Configure Parameters using the ICIM.....	53
CONFIG Menus.....	53
Checking Module Alarms using the ICIM.....	55
To Check Alarms using ICIM.....	55
ALARMS Menus.....	55
To Set Adjustable Alarm Thresholds using the ICIM.....	56
Alarm Threshold Menus.....	56
Checking Manufacturing Data using the ICIM	58
To Check Manufacturing Data	58
MFG. DATA Menus	58
Saving the Configuration using the ICIM.....	60
To Save the Current Configuration.....	60
Configuration Complete	60
Adjusting Alarm Thresholds.....	61
To Adjust Alarm Thresholds	61

Operation Using LCI 63

LCI Introduction	64
Laser Warning	64
LCI Function	64
System Requirements	65
Computer Requirements.....	65
Cable Requirements	65
Installing LCI.....	66
To Install the LCI Software	66
Connecting Your Computer to the Chassis.....	70
To Connect a Computer to the Chassis.....	70
Starting LCI Software	72
To Start LCI Software	72
LCI Module Tree.....	74
Introduction	74
Module Tree Levels.....	74
Accessing Module Details	75
Module Details Window.....	75

Contents

Checking the Operating Status	76
To Check the Operating Status using LCI	76
Configuring the Module using LCI	78
To Configure Parameters using LCI	78
Checking the Module Alarms using LCI	80
To Check Alarms using LCI.....	80
Modifying Module Alarm Limits using LCI.....	82
To Modify Alarm Limits using LCI	82
Checking Manufacturing Data using LCI.....	84
To Check Manufacturing Data using LCI.....	84

Maintenance and Troubleshooting 87

Maintenance	88
Maintenance Record.....	88
General Troubleshooting Information	89
Equipment Needed	89
Additional Assistance	89
Troubleshooting.....	89
Troubleshooting Alarm Conditions.....	90
Module Alarm Conditions.....	90

Customer Information 91

Appendix A Module Parameter Descriptions 93

High Density Long Reach Multiwave and Hybrid Modulation QAM Transmitter Parameters	94
Operating Status Parameters	94
Configurable Parameters	95
Alarm Data Parameters.....	96
Alarm Types.....	97
Manufacturing Data Parameter Examples	97

Glossary 99

Important Safety Instructions

Read these instructions. Keep these instructions. Heed all warnings. Follow all instructions. Only use attachments/accessories specified by the manufacturer.

Read and Retain Instructions

Carefully read all safety and operating instructions before operating this equipment, and retain them for future reference.

Follow Instructions and Heed Warnings

Follow all operating and use instructions. Pay attention to all warnings and cautions in the operating instructions, as well as those that are affixed to this equipment.

Terminology

The terms defined below are used in this document. The definitions given are based on those found in safety standards.

Service Personnel - The term *service personnel* applies to trained and qualified individuals who are allowed to install, replace, or service electrical equipment. The service personnel are expected to use their experience and technical skills to avoid possible injury to themselves and others due to hazards that exist in service and restricted access areas.

User and Operator - The terms *user* and *operator* apply to persons other than service personnel.

Ground(ing) and Earth(ing) - The terms *ground(ing)* and *earth(ing)* are synonymous. This document uses *ground(ing)* for clarity, but it can be interpreted as having the same meaning as *earth(ing)*.

Electric Shock Hazard

This equipment meets applicable safety standards.



WARNING:

To reduce risk of electric shock, perform only the instructions that are included in the operating instructions. Refer all servicing to qualified service personnel only.

Important Safety Instructions

Electric shock can cause personal injury or even death. Avoid direct contact with dangerous voltages at all times. The protective ground connection, where provided, is essential to safe operation and must be verified before connecting the power supply.

Know the following safety warnings and guidelines:

- Dangerous Voltages
 - Only qualified service personnel are allowed to perform equipment installation or replacement.
 - Only qualified service personnel are allowed to remove chassis covers and access any of the components inside the chassis.
- Grounding
 - Do not violate the protective grounding by using an extension cable, power cable, or autotransformer without a protective ground conductor.
 - Take care to maintain the protective grounding of this equipment during service or repair and to re-establish the protective grounding before putting this equipment back into operation.

Installation Site

When selecting the installation site, comply with the following:

- **Protective Ground** - The protective ground lead of the building's electrical installation should comply with national and local requirements.
- **Environmental Condition** - The installation site should be dry, clean, and ventilated. Do not use this equipment where it could be at risk of contact with water. Ensure that this equipment is operated in an environment that meets the requirements as stated in this equipment's technical specifications, which may be found on this equipment's data sheet.

Installation Requirements



WARNING:

Allow only qualified service personnel to install this equipment. The installation must conform to all local codes and regulations.

Equipment Placement



WARNING:

Avoid personal injury and damage to this equipment. An unstable mounting surface may cause this equipment to fall.

Important Safety Instructions

To protect against equipment damage or injury to personnel, comply with the following:

- Install this equipment in a restricted access location.

Important Safety Instructions

- Do not install near any heat sources such as radiators, heat registers, stoves, or other equipment (including amplifiers) that produce heat.
- Place this equipment close enough to a mains AC outlet to accommodate the length of this equipment's power cord.
- Route all power cords so that people cannot walk on, place objects on, or lean objects against them. This may pinch or damage the power cords. Pay particular attention to power cords at plugs, outlets, and the points where the power cords exit this equipment.
- Use only with a cart, stand, tripod, bracket, or table specified by the manufacturer, or sold with this equipment.
- Make sure the mounting surface or rack is stable and can support the size and weight of this equipment.
- The mounting surface or rack should be appropriately anchored according to manufacturer's specifications. Ensure this equipment is securely fastened to the mounting surface or rack where necessary to protect against damage due to any disturbance and subsequent fall.

Ventilation

This equipment has openings for ventilation to protect it from overheating. To ensure equipment reliability and safe operation, do not block or cover any of the ventilation openings. Install the equipment in accordance with the manufacturer's instructions.

Rack Mounting Safety Precautions

Mechanical Loading

Make sure that the rack is placed on a stable surface. If the rack has stabilizing devices, install these stabilizing devices before mounting any equipment in the rack.



WARNING:

Avoid personal injury and damage to this equipment. Mounting this equipment in the rack should be such that a hazardous condition is not caused due to uneven mechanical loading.

Reduced Airflow

When mounting this equipment in the rack, do not obstruct the cooling airflow through the rack. Be sure to mount the blanking plates to cover unused rack space. Additional components such as combiners and net strips should be mounted at the back of the rack, so that the free airflow is not restricted.



CAUTION:

Installation of this equipment in a rack should be such that the amount of airflow required for safe operation of this equipment is not compromised.

Elevated Operating Ambient Temperature

Only install this equipment in a humidity- and temperature-controlled environment that meets the requirements given in this equipment's technical specifications.



CAUTION:

If installed in a closed or multi-unit rack assembly, the operating ambient temperature of the rack environment may be greater than room ambient temperature. Therefore, install this equipment in an environment compatible with the manufacturer's maximum rated ambient temperature.

Handling Precautions

When moving a cart that contains this equipment, check for any of the following possible hazards:



WARNING:



Avoid personal injury and damage to this equipment! Move any equipment and cart combination with care. Quick stops, excessive force, and uneven surfaces may cause this equipment and cart to overturn.

- Use caution when moving this equipment/cart combination to avoid injury from tip-over.
- If the cart does not move easily, this condition may indicate obstructions or cables that may need to be disconnected before moving this equipment to another location.
- Avoid quick stops and starts when moving the cart.
- Check for uneven floor surfaces such as cracks or cables and cords.

Grounding

This section provides instructions for verifying that the equipment is properly grounded.

Safety Plugs (USA Only)

This equipment may be equipped with either a 3-terminal (grounding-type) safety plug or a 2-terminal (polarized) safety plug. The wide blade or the third terminal is provided for safety. Do not defeat the safety purpose of the grounding-type or polarized safety plug.

Important Safety Instructions

To properly ground this equipment, follow these safety guidelines:

- **Grounding-Type Plug** - For a 3-terminal plug (one terminal on this plug is a protective grounding pin), insert the plug into a grounded mains, 3-terminal outlet.

Note: This plug fits only one way. If this plug cannot be fully inserted into the outlet, contact an electrician to replace the obsolete 3-terminal outlet.

- **Polarized Plug** - For a 2-terminal plug (a polarized plug with one wide blade and one narrow blade), insert the plug into a polarized mains, 2-terminal outlet in which one socket is wider than the other.

Note: If this plug cannot be fully inserted into the outlet, try reversing the plug. If the plug still fails to fit, contact an electrician to replace the obsolete 2-terminal outlet.

Grounding Terminal

If this equipment is equipped with an external grounding terminal, attach one end of an 18-gauge wire (or larger) to the grounding terminal; then, attach the other end of the wire to a ground, such as a grounded equipment rack.

Safety Plugs (European Union)

- **Class I Mains Powered Equipment** - Provided with a 3-terminal AC inlet and requires connection to a 3-terminal mains supply outlet via a 3-terminal power cord for proper connection to the protective ground.

Note: The equipotential bonding terminal provided on some equipment is not designed to function as a protective ground connection.

- **Class II Mains Powered Equipment** - Provided with a 2-terminal AC inlet that may be connected by a 2-terminal power cord to the mains supply outlet. No connection to the protective ground is required as this class of equipment is provided with double or reinforced and/or supplementary insulation in addition to the basic insulation provided in Class I equipment.

Note: Class II equipment, which is subject to EN 50083-1, is provided with a chassis mounted equipotential bonding terminal. See the section titled **Equipotential Bonding** for connection instructions.

Equipotential Bonding

If this equipment is equipped with an external chassis terminal marked with the IEC 60417-5020 chassis icon () , the installer should refer to CENELEC standard EN 50083-1 or IEC standard IEC 60728-11 for correct equipotential bonding connection instructions.

AC Power

Important: If this equipment is a Class I equipment, it must be grounded.

- If this equipment plugs into an outlet, the outlet must be near this equipment, and must be easily accessible.
- Connect this equipment only to the power sources that are identified on the equipment-rating label normally located close to the power inlet connector(s).
- This equipment may have two power sources. Be sure to disconnect all power sources before working on this equipment.
- If this equipment **does not** have a main power switch, the power cord connector serves as the disconnect device.
- Always pull on the plug or the connector to disconnect a cable. Never pull on the cable itself.
- Unplug this equipment when unused for long periods of time.

Connection to -48 VDC/-60 VDC Power Sources

If this equipment is DC-powered, refer to the specific installation instructions in this manual or in companion manuals in this series for information on connecting this equipment to nominal -48 VDC/-60 VDC power sources.

Circuit Overload

Know the effects of circuit overloading before connecting this equipment to the power supply.



CAUTION:

Consider the connection of this equipment to the supply circuit and the effect that overloading of circuits might have on overcurrent protection and supply wiring. Refer to the information on the equipment-rating label when addressing this concern.

General Servicing Precautions



WARNING:

Avoid electric shock! Opening or removing this equipment's cover may expose you to dangerous voltages.



CAUTION:

These servicing precautions are for the guidance of qualified service personnel only. To reduce the risk of electric shock, do not perform any servicing other than that contained in the operating instructions unless you are qualified to do so. Refer all servicing to qualified service personnel.

Important Safety Instructions

Be aware of the following general precautions and guidelines:

- **Servicing** - Servicing is required when this equipment has been damaged in any way, such as power supply cord or plug is damaged, liquid has been spilled or objects have fallen into this equipment, this equipment has been exposed to rain or moisture, does not operate normally, or has been dropped.
- **Wristwatch and Jewelry** - For personal safety and to avoid damage of this equipment during service and repair, do not wear electrically conducting objects such as a wristwatch or jewelry.
- **Lightning** - Do not work on this equipment, or connect or disconnect cables, during periods of lightning.
- **Labels** - Do not remove any warning labels. Replace damaged or illegible warning labels with new ones.
- **Covers** - Do not open the cover of this equipment and attempt service unless instructed to do so in the instructions. Refer all servicing to qualified service personnel only.
- **Moisture** - Do not allow moisture to enter this equipment.
- **Cleaning** - Use a damp cloth for cleaning.
- **Safety Checks** - After service, assemble this equipment and perform safety checks to ensure it is safe to use before putting it back into operation.

Electrostatic Discharge

Electrostatic discharge (ESD) results from the static electricity buildup on the human body and other objects. This static discharge can degrade components and cause failures.

Take the following precautions against electrostatic discharge:

- Use an anti-static bench mat and a wrist strap or ankle strap designed to safely ground ESD potentials through a resistive element.
- Keep components in their anti-static packaging until installed.
- Avoid touching electronic components when installing a module.

Fuse Replacement

To replace a fuse, comply with the following:

- Disconnect the power before changing fuses.
- Identify and clear the condition that caused the original fuse failure.
- Always use a fuse of the correct type and rating. The correct type and rating are indicated on this equipment.

Batteries

This product may contain batteries. Special instructions apply regarding the safe use and disposal of batteries:

Safety

- Insert batteries correctly. There may be a risk of explosion if the batteries are incorrectly inserted.
- Do not attempt to recharge 'disposable' or 'non-reusable' batteries.
- Please follow instructions provided for charging 'rechargeable' batteries.
- Replace batteries with the same or equivalent type recommended by manufacturer.
- Do not expose batteries to temperatures above 100°C (212°F).

Disposal

- The batteries may contain substances that could be harmful to the environment
- Recycle or dispose of batteries in accordance with the battery manufacturer's instructions and local/national disposal and recycling regulations.



廢電池請回收

- The batteries may contain perchlorate, a known hazardous substance, so special handling and disposal of this product might be necessary. For more information about perchlorate and best management practices for perchlorate-containing substance, see www.dtsc.ca.gov/hazardouswaste/perchlorate.

Modifications

This equipment has been designed and tested to comply with applicable safety, laser safety, and EMC regulations, codes, and standards to ensure safe operation in its intended environment. Refer to this equipment's data sheet for details about regulatory compliance approvals.

Do not make modifications to this equipment. Any changes or modifications could void the user's authority to operate this equipment.

Modifications have the potential to degrade the level of protection built into this equipment, putting people and property at risk of injury or damage. Those persons making any modifications expose themselves to the penalties arising from proven non-compliance with regulatory requirements and to civil litigation for compensation in respect of consequential damages or injury.

Accessories

Use only attachments or accessories specified by the manufacturer.

Electromagnetic Compatibility Regulatory Requirements

This equipment meets applicable electromagnetic compatibility (EMC) regulatory requirements. Refer to this equipment's data sheet for details about regulatory compliance approvals. EMC performance is dependent upon the use of correctly shielded cables of good quality for all external connections, except the power source, when installing this equipment.

- Ensure compliance with cable/connector specifications and associated installation instructions where given elsewhere in this manual.

Otherwise, comply with the following good practices:

- Multi-conductor cables should be of single-braided, shielded type and have conductive connector bodies and backshells with cable clamps that are conductively bonded to the backshell and capable of making 360° connection to the cable shielding. Exceptions from this general rule will be clearly stated in the connector description for the excepted connector in question.
- Ethernet cables should be of single-shielded or double-shielded type.
- Coaxial cables should be of the double-braided shielded type.

EMC Compliance Statements

Where this equipment is subject to USA FCC and/or Industry Canada rules, the following statements apply:

FCC Statement for Class A Equipment

This equipment has been tested and found to comply with the limits for a Class A digital device, pursuant to Part 15 of the FCC Rules. These limits are designed to provide reasonable protection against harmful interference when this equipment is operated in a commercial environment.

This equipment generates, uses, and can radiate radio frequency energy and, if not installed and used in accordance with the instruction manual, may cause harmful interference to radio communications. Operation of this equipment in a residential area is likely to cause harmful interference in which case users will be required to correct the interference at their own expense.

Industry Canada - Industrie Canadienne Statement

This apparatus complies with Canadian ICES-003.
Cet appareil est conforme à la norme NMB-003 du Canada.

CENELEC/CISPR Statement with Respect to Class A Information Technology Equipment

This is a Class A equipment. In a domestic environment this equipment may cause radio interference in which case the user may be required to take adequate measures.

Laser Safety

Introduction

This equipment contains an infrared laser that transmits intensity-modulated light and emits invisible radiation.

Warning: Radiation



WARNING:

- **Avoid personal injury! Use of controls, adjustments, or procedures other than those specified herein may result in hazardous radiation exposure.**
 - **Avoid personal injury! The laser light source on this equipment (if a transmitter) or the fiber cables connected to this equipment emit invisible laser radiation. Avoid direct exposure to the laser light source.**
 - **Avoid personal injury! Viewing the laser output (if a transmitter) or fiber cable with optical instruments (such as eye loupes, magnifiers, or microscopes) may pose an eye hazard.**
- Do not apply power to this equipment if the fiber is unmated or unterminated.
 - Do not stare into an unmated fiber or at any mirror-like surface that could reflect light emitted from an unterminated fiber.
 - Do not view an activated fiber with optical instruments such as eye loupes, magnifiers, or microscopes.
 - Use safety-approved optical fiber cable to maintain compliance with applicable laser safety requirements.

Warning: Fiber Optic Cables



WARNING:

Avoid personal injury! Qualified service personnel may only perform the procedures in this manual. Wear safety glasses and use extreme caution when handling fiber optic cables, particularly during splicing or terminating operations. The thin glass fiber core at the center of the cable is fragile when exposed by the removal of cladding and buffer material. It easily fragments into glass splinters. Using tweezers, place splinters immediately in a sealed waste container and dispose of them safely in accordance with local regulations.

Safe Operation for Software Controlling Optical Transmission Equipment

If this document discusses software, the software described is used to monitor and/or control ours and other vendors' electrical and optical

Laser Safety

equipment designed to transmit video, voice, or data signals. Certain safety precautions must be observed when operating equipment of this nature.

For equipment specific safety requirements, refer to the appropriate section of the equipment documentation.

For safe operation of this software, refer to the following warnings.



WARNING:

- **Ensure that all optical connections are complete or terminated before using this equipment to remotely control a laser device. An optical or laser device can pose a hazard to remotely located personnel when operated without their knowledge.**
- **Allow only personnel trained in laser safety to operate this software. Otherwise, injuries to personnel may occur.**
- **Restrict access of this software to authorized personnel only.**
- **Install this software in equipment that is located in a restricted access area.**

Laser Power and Warning Labels - Half Height Module

Warning Labels

The following labels are located on this product.

Laser Warning Label *



Laser Classification Label



* Located on host module (part number 4008281) only.

Product and Laser Information Label



Location of Labels on Equipment

The following illustrations display the location of warning labels on this equipment.

Laser Power and Warning Labels - Half Height Module

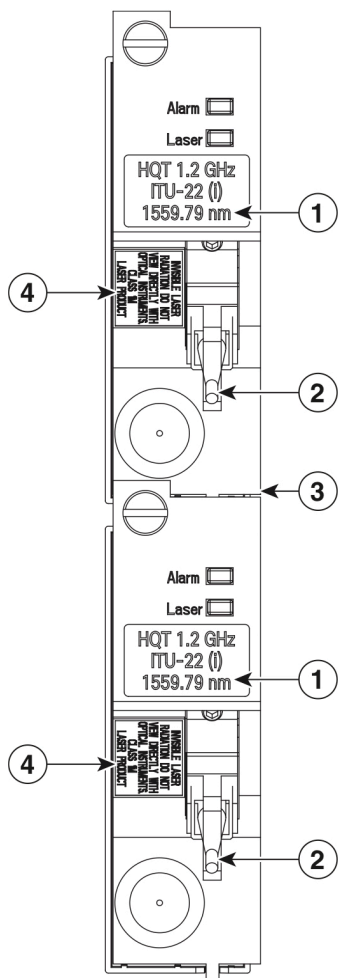

1	ITU Wavelength Label (value shown is example only)	3	Product and Laser Information Label on Side of Module
2	Laser Aperture Output	4	Laser Classification Label

1

Introduction

Overview

This chapter describes the Cisco Prisma II 1.2 GHz High Density Long Reach Multiwave (HD-LRMW) and Hybrid Modulation QAM (HQT) Transmitters.

Purpose

This guide provides information about the transmitter. It describes the front and back panels and presents a setup summary for the transmitter.

Who Should Use This Document

This document is intended for authorized service personnel who have experience working with similar equipment. The service personnel should have appropriate background and knowledge to complete the procedures described in this document.

Qualified Personnel

Only appropriately qualified and skilled personnel should attempt to install, operate, maintain, and service this product.



WARNING:

Only appropriately qualified and skilled personnel should attempt to install, operate, maintain, and service this product. Otherwise, personal injury or equipment damage may occur.

Scope

This guide discusses the following topics:

- Description of the transmitter
- Installation procedures
- Operation using the ICIM
- Operation using LCI
- Maintenance and troubleshooting

In This Chapter

- Description **Error! Bookmark not defined.**
- High Density Transmitter Front and Back Panel**Error! Bookmark not de**
- Host Module..... **Error! Bookmark not defined.**
- Module Configuration..... **Error! Bookmark not defined.**

Description

The Prisma II 1.2 GHz HD-LRMW and HQT Transmitters are plug-in modules for the Prisma II and the Prisma II XD platforms. These modules are part of the Prisma II optical network, an advanced transmission system designed to optimize network architectures and increase reliability, scalability, and cost effectiveness.

The transmitters install into a Prisma II XD Chassis directly, or into a standard Prisma II Chassis by means of a host module that accepts up to two Prisma II High Density application modules.

The transmitters are designed to operate over a wide range of loss budgets and digital signal loads. Microprocessor control allows ease of installation and flexibility of application.

The transmitter design includes an array of capabilities, such as low RF input level, broadcast, and elective Automatic Gain Control (AGC).

Features

The high density transmitter has the following features:

- Front panel green light emitting diode (LED) to indicate operating status
- Front panel red LED to indicate alarm status
- -20 dB test point
- Optical output connector
- Plug-and-play capability
- Compatible with Intelligent Communications Interface Module (ICIM) and Local Craft Interface (LCI) software
- Blind-mate radio frequency (RF) connections

Operation

The transmitter receives an RF signal through a connector on the rear of the module. The RF input signal is amplified and converted to an optical signal. This module employs an Indium Phosphide-based hybrid laser/modulator structure to both generate the optical carrier and modulate this optical carrier with the input RF signal.

The incoming RF signal is amplified and then routed through a coupler to an RF detector circuit. The detector circuit produces a DC voltage proportional

to the incident RF power. A controller monitors this voltage level to evaluate the input power level. The transmitter generates an alarm condition if the input power is over or under a specified level.

The amplified RF signal is also routed to a variable attenuator, which is used to reduce RF power in an overdrive condition or compensate for gain variations in the transmitter. The signal is equalized, impedance-matched, and then sent to the laser. The optical output connector is located on the front panel of the module.

Transmitter gain is controlled through the selection of Manual or Automatic Gain Control (AGC) mode operation.

- In Manual mode, an attenuator can be used to reduce RF power in an overdrive condition or to compensate for variations in transmitter gain. Any manual attenuator adjustments are reflected in the indicated RF drive level. It may be desirable to make such adjustments to compensate for power differences if the channel load differs from the specified value.
- In AGC mode, the microprocessor monitors the actual input composite power and adjusts the attenuator to maintain constant RF drive level into the laser diode.

After the RF amplification and control stage, the signal is equalized and impedance-matched, and then is sent to the hybrid laser/modulator. The optical output connector is located on the front panel of the module.

The user can turn the laser on or off, adjust the drive level to the laser, and set alarm levels. The module can be controlled either locally using LCI, the ICIM front-panel interface, or remotely using CLI commands or the ICIM Web Interface.

Optical Output

The optical output connectors are SC/APC.



WARNING:

Avoid damage to your eyes! Do not look into any optical connector while the system is active. Even if the unit is off, there may still be hazardous optical levels present.

Transmitter Block Diagram

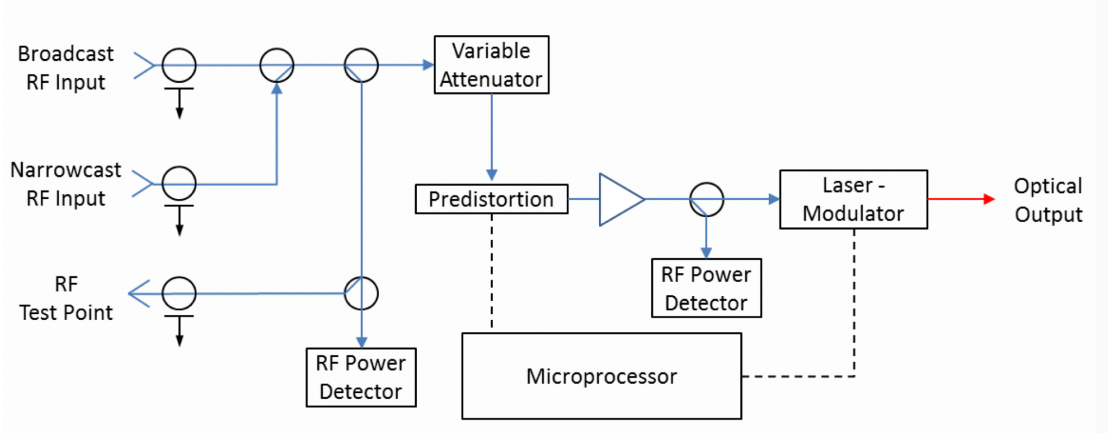

High Density Transmitter Front and Back Panel

High Density Transmitter Illustration

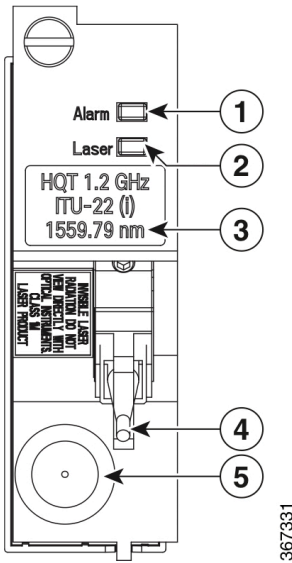

1	Alarm Indicator	4	Optical Output
2	Laser Indicator	5	-20dB Test Point
3	ITU Wavelength Label (value shown is example only)		

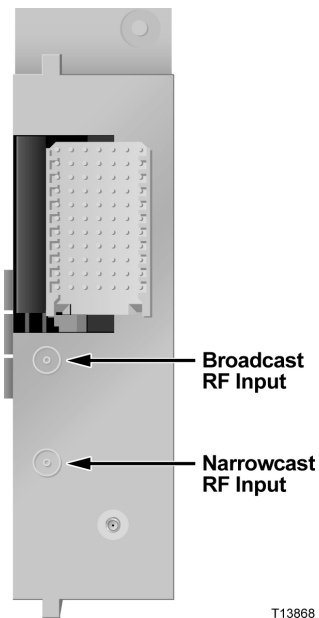

High Density Transmitter Front Panel Features

Part	Function
Alarm Indicator	Illuminates or blinks when an alarm condition occurs.
Laser Indicator	Illuminates when laser is active.
Optical Output	Connects the output signal to the optical cable.
-20 dB Test Point	Provides a -20 dB sample of the RF output signal.

Back Panel Connectors

Blind-mate connectors make it easy to install this module. The push-on connector on the back of the module mates with the back plane bus connector inside the chassis or host module. This 55-pin connector and the RF connector provide the following facilities.

- RF signal connection
- Electrical power input connection
- Alarm communications connections
- Status-monitoring communications
- Communications and control connections

The ESD guide pin near the bottom of the back panel serves as both a guide pin and an ESD ground connection. The length of the pin ensures that ground is the first electrical connection made as the module is inserted, and the last connection to be broken as the module is removed.

Host Module

A host module is required to mount high density application modules in a standard Prisma II Chassis. The host module doubles the density of the Prisma II Chassis by providing two high density module slots for each current Prisma II slot. Its simple design allows for efficient routing of RF and electrical signal between the chassis back plane and each high density module.

Host Module Features

The host module has the following features:

- Provides upper and lower slots for two high density modules
- Incorporates a passive design for high reliability
- Provides for RF and DC routing between the chassis back plane and each high density module

Host Module Illustration

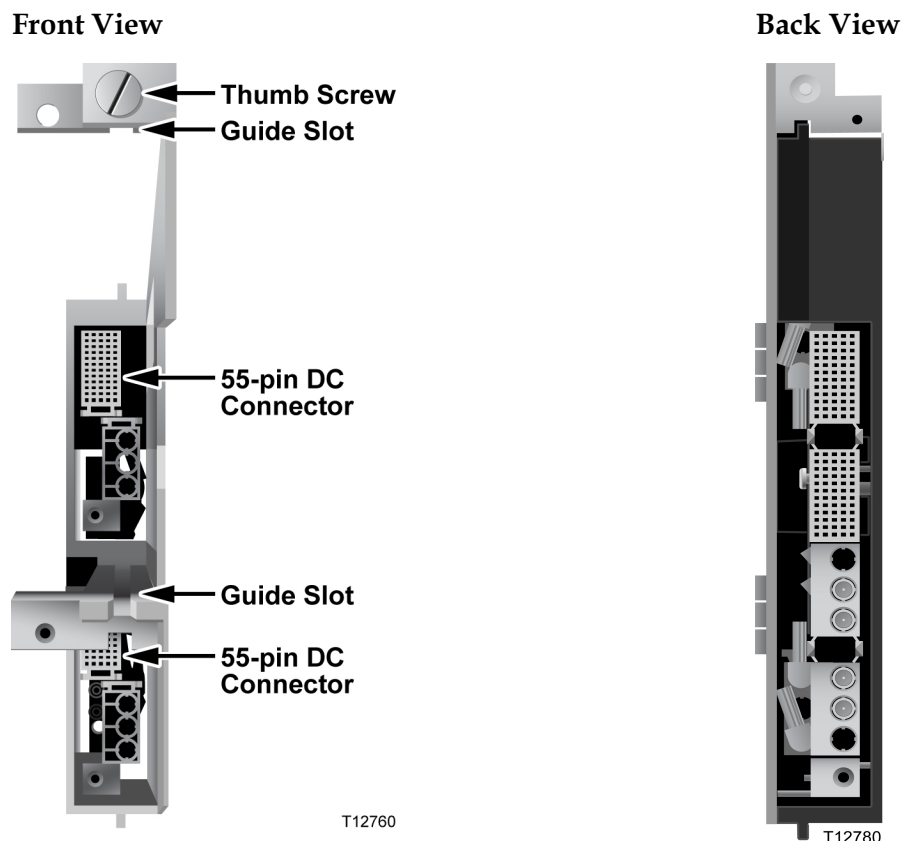

Side View

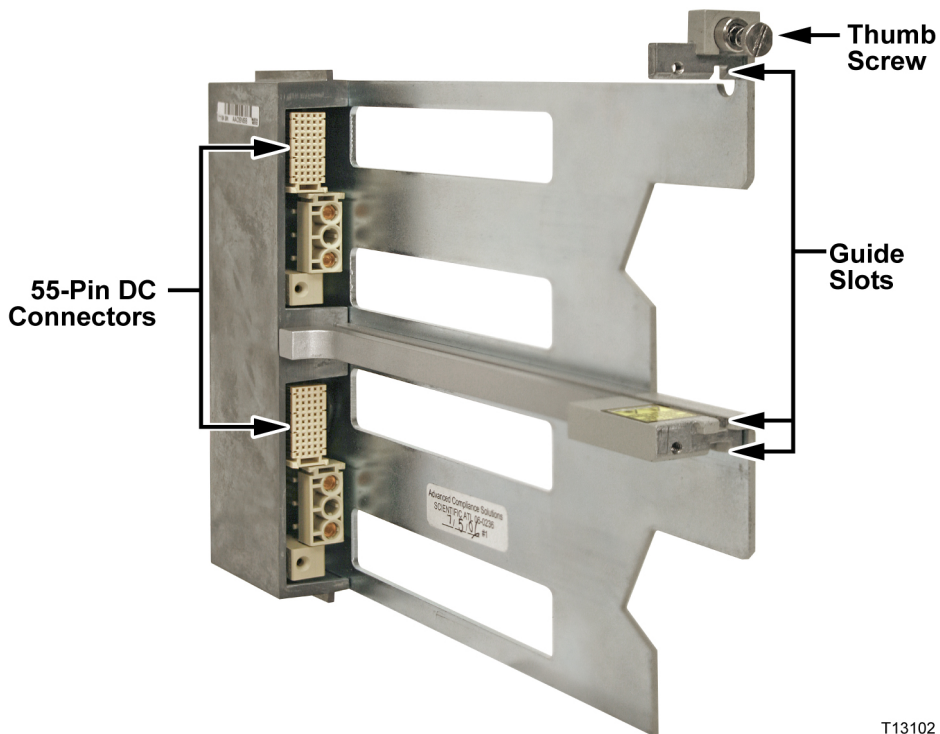

T13102

Host Module Back Panel Connectors

Blind-mate connectors make it easy to install the host module. The push-on connector on the back of the module mates with the back plane bus connector inside the chassis. This 110-pin connector provides the following facilities:

- RF signal input connection
- Electrical power input connection
- Alarm communications connections
- Status-monitoring connections
- Communications and control connections

Module Configuration

The transmitter ships from the factory with operational parameters set to factory defaults. However, you may choose to configure the operating parameters so that they are best suited for your application.

Configuration and Monitoring Methods

The module may be controlled and monitored using any of the following methods.

- Prisma II ICIM Front Panel

When a standard Intelligent Communications Interface Module 2 (ICIM2) is used, its front-panel LCD and keypad interface can be used to configure and monitor this and other Prisma II modules in the ICIM domain. For instructions on operating this module using this ICIM, refer to *Operation using ICIM* (on page 37).

- LCI Software

Local Craft Interface (LCI) software running on a locally connected PC may be used to configure operating parameters of Prisma II modules. For instructions on operating this module using LCI software, refer to *Operation using LCI* (on page 63).

- CLI Commands

If an ICIM2 or ICIM2-XD is installed, command line interface (CLI) commands enable communication between the ICIM and the operator over Telnet to allow for remote module setup and monitoring. For details, see the *Prisma II Platform Remote User Interface Guide, System Release 2.03*, part number 4025477.

- ICIM Web Interface

The ICIM Web Interface offers a user-friendly alternative to CLI commands for remote module setup and monitoring using an ICIM2 or ICIM2-XD. Users navigate a series of HTML pages through a standard web browser to view and, where permitted, adjust module parameters. For additional information, see the *Prisma II Platform Remote User Interface Guide, System Release 2.03*, part number 4025477.

Configuration Summary

You can use any of the methods listed above to perform the following configuration tasks:

- Enable or disable transmitter operation

Chapter 1 Introduction

- Enable or disable the “RF input low” alarm
- Configure the module as master or slave
- Set the relative RF drive level into the transmitter
- Return to the factory default settings (except LCI)
- Turns automatic gain control (AGC) on or off

For detailed information on configuring this module, refer to *Operation using ICIM* (on page 37) or *Operation using LCI* (on page 63).

2

Module Installation

This chapter provides instructions and identifies the site requirements, tools, and equipment needed to install this module.

Qualified Personnel



WARNING:

Allow only qualified personnel to install, operate, maintain, or service this product. Otherwise, personal injury or equipment damage may occur.

In This Chapter

- Preparing for Installation **Error! Bookmark not defined.**
- Site Requirements **Error! Bookmark not defined.**
- Connecting the RF Cables to the Chassis **Error! Bookmark not defined.**
- Installing the HD Module in the Chassis **Error! Bookmark not defined.**
- Routing Optical Cables **Error! Bookmark not defined.**
- Cleaning Optical Connectors **Error! Bookmark not defined.**
- Connecting Optical Cables **Error! Bookmark not defined.**
- Connecting the ICIM to Additional Chassis **Error! Bookmark not defined.**
- External Alarm Connections **Error! Bookmark not defined.**

Preparing for Installation

Before you begin, make sure that the module is in good condition and that you have the tools and equipment listed here.

Unpacking and Inspecting the Module

As you unpack the module, inspect it for shipping damage. If you find any damage, contact Cisco Services. Refer to *Customer Information* (on page 91) for contact information.

Equipment and Tools Needed

Before you begin, make sure that the module is in good condition. You need the following equipment and tools to install these modules.

You need . . .	To . . .
A standard Prisma II Chassis with power supply	Provide housing, power, and input and output connections to the module.
A 3/8-in. flat-blade screwdriver	Secure the module in the chassis.
A 7/16-in. open-end wrench	Secure RF cable connectors at the chassis.
One RF cable with connectors	Carry RF input signals.

Site Requirements

Before you begin, be sure that your installation site meets the requirements discussed in this section.

Access Requirements

Ensure that only authorized personnel have access to this equipment. Otherwise, personal injury or equipment damage may occur.



WARNING:

Use this product in locations that restrict access to all persons who are not authorized. Otherwise, personal injury or equipment damage may occur.

Equipment Rack

To install the modules, your site should be equipped with an Electronics Industry Association (EIA) equipment rack that properly houses the Prisma II Chassis with proper spacing for air circulation. For instructions on installing the chassis in the rack, refer to the guide that was shipped with the chassis.

Operating Environment



CAUTION:

Avoid damage to this product! Operating this product outside the specified operating temperature limits voids the warranty.

Follow these recommendations to maintain an acceptable operating temperature:

- Temperature inside the rack must be between 0°C and 50°C (32°F and 122°F)
- Keep cooling vents clear and free of obstructions.
- Provide ventilation, as needed, using one or more of the following methods:
 - Air-deflecting baffles
 - Forced-air ventilation
 - Air outlets above enclosures

Power Requirements

Prisma II modules receive their electrical power from the Prisma II Chassis. The module may be installed with the chassis under power.

Space Requirements

This is a single-width, half-height module. Actual space requirements depend on whether the module is installed in a Prisma II standard or a Prisma II XD chassis.

Prisma II Standard Chassis Installation

When installed in a Prisma II standard chassis, the module is placed in a host module and then inserted into the chassis in slots 5 through 16.

- If the module occupies the upper host module position, its slot number is the same (5 through 16) as that of the host module.
- If the module occupies the lower host module position, its slot number is 16 plus the host module slot number, or 21 through 32.

Slots 1 through 4 are usually reserved for the power supplies. If an ICIM is installed, it occupies slots 15 and 16. If an ICIM is not installed, any other module (or host module) can occupy these slots.

Slots 2 and 4 are reserved for an internal power supply, if installed. If an internal power supply is not installed here, any other module (or host module) can occupy these slots.

Prisma II XD Chassis Installation

When installed in a Prisma II XD Chassis, the module is inserted directly into an available application module slot on the chassis front panel. The application module slots are numbered 1 through 16.

The chassis power supplies and ICIM are installed in dedicated slots on the chassis back panel, so slots 1 through 16 are available for application modules regardless of chassis configuration.

Standard Prisma II Chassis

The standard Prisma II Chassis may be configured with front or rear connectors depending on the system you have purchased. Power, RF input/output, and other connectors may be located on either the front or rear of the Prisma II Chassis. Connections to the chassis serve the same function and are made in the same manner regardless of the location of the connectors or chassis configuration.

Rear-Access Chassis - Front Panel Illustration

The following illustration shows the front of the rear-access Prisma II standard chassis with two power supplies, 10 full-height modules, and the ICIM installed.

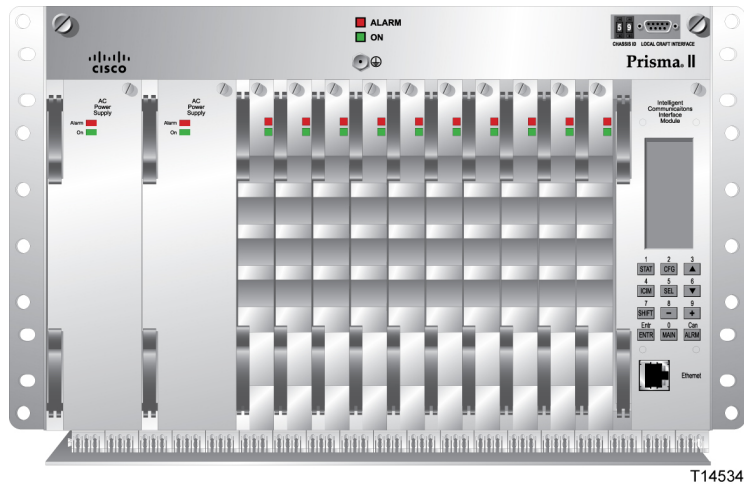

T14534

Front-Access Chassis - Front Panel Illustration

The following illustration shows the front of the front-access Prisma II standard chassis with two power supplies, 10 full-height modules, and the ICIM installed.

The power inlets, RF input/output, and RF ports are located on the recessed bottom of the connector interface panel on the front-access version of the chassis.

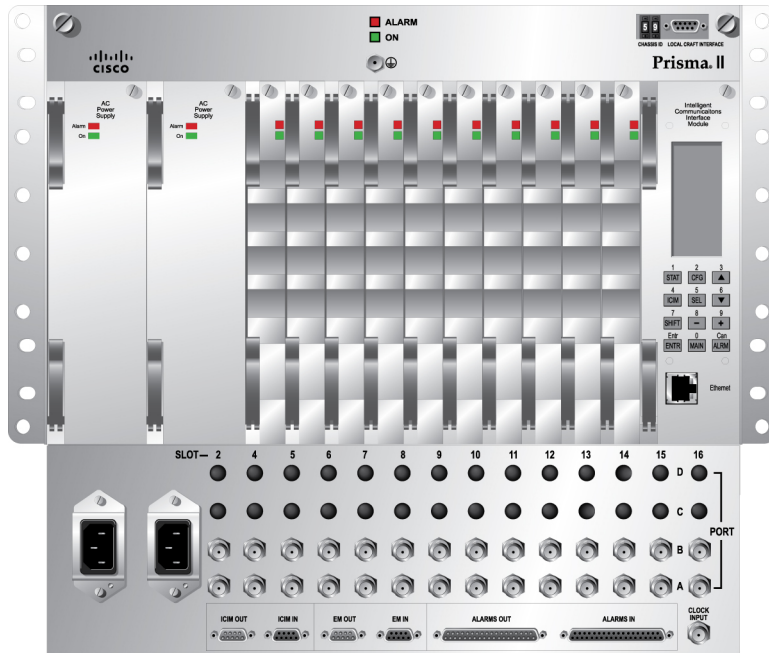

T14535

Prisma II XD Chassis Style

The Prisma II XD chassis back panel serves as both a connector panel and a receptacle for AC power supply modules and the ICIM2-XD, when installed.

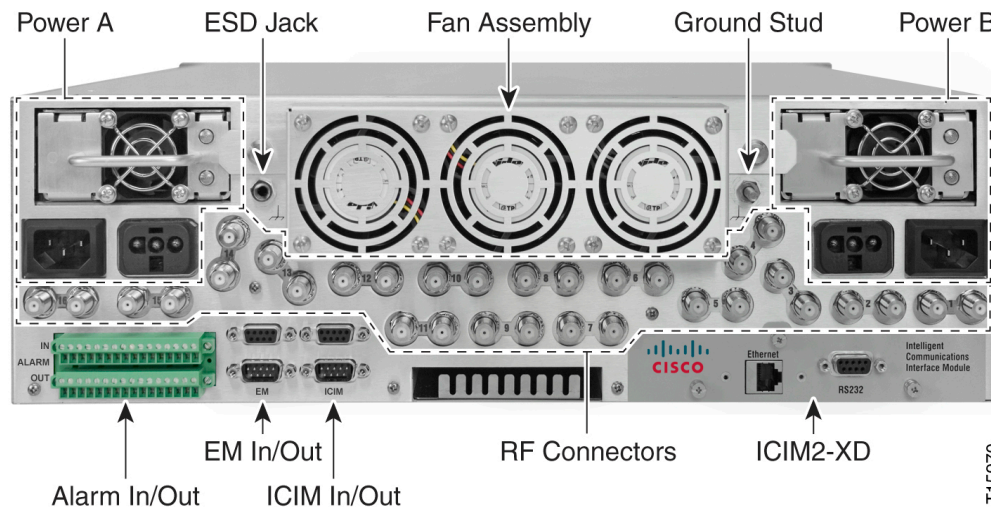

T15970

The RF connectors are arranged in numbered pairs to identify the corresponding application module slot. One connector in each pair has a black retaining nut and a black circle in the panel artwork to mark it as belonging to the upper connector on the chassis midplane.

Connecting the RF Cables to the Chassis

To Connect RF Cables for Each Module

Complete the appropriate procedure below to connect RF cables for the module.

Note: These procedures assume that the chassis is mounted in a rack.

Standard Prisma II Chassis

- 1 Attach a 75-ohm RF cable to the appropriate RF source.
- 2 At the front/rear of the chassis, locate the RF ports.

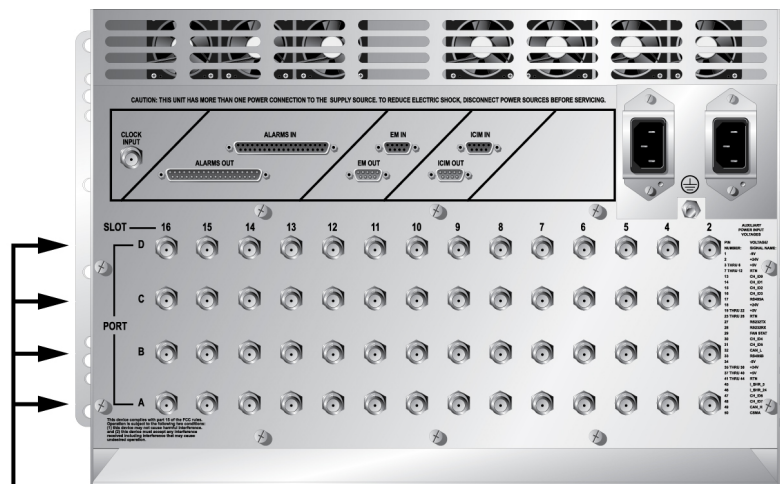

RF Ports

T12770

Note: RF ports are located on the front of the front access chassis.

- 3 Attach the other end of the RF cable to Port A connector (RF IN) of the corresponding slot where the module is to be installed. This is the RF input connection.

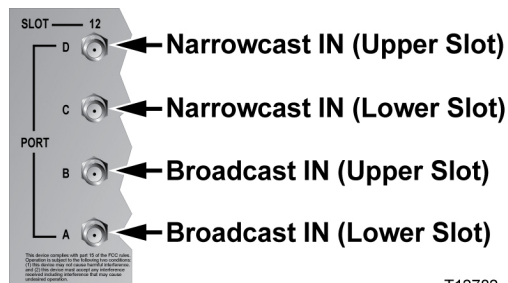

T12782

- 4 If F-connectors are installed, use a 7/16-in. open-end wrench to secure both cables to the connectors at the chassis.

Prisma II XD Chassis

- 1 Attach a 75-ohm RF cable to the appropriate RF source.
- 2 Locate the RF ports at the back of the chassis.

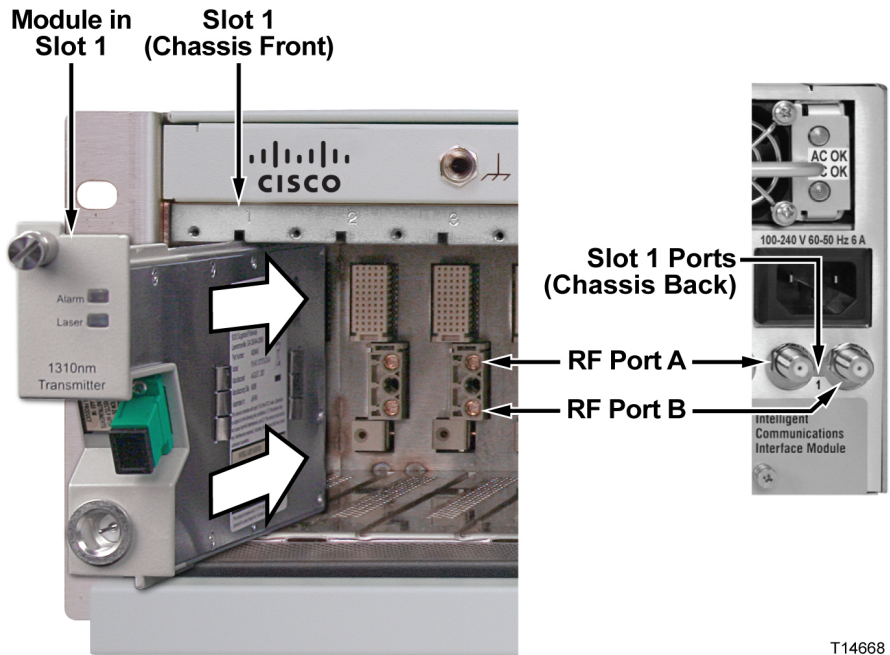

T14668

- 3 Attach the other end of the RF cable to Port A connector (RF IN) of the corresponding slot where the module is to be installed. This is the RF input connection.
- 4 If F-connectors are installed, use a 7/16-in. open-end wrench to secure both cables to the connectors at the chassis.

Installing the HD Module in the Chassis

To Install the Transmitter Modules in the Host Module

Note:

- All Prisma II high-density application modules must be installed in a host module before they can be mounted in a standard Prisma II Chassis.
- Prisma II host modules prior to Rev C (date codes through A2006) do not support the Controller Area Network (CAN) bus.
- To support CAN bus redundancy, the ICIM2 must be Rev B or later.

Complete the following steps to install the application modules in the host module:

- 1 Align the ridges on the top and bottom of the module with the guide slots located on the host module and the chassis. Be careful to keep the module level as you slide it into the host to avoid bending the pins on the host back plane.
- 2 Gently slide the module into the host module until you feel the power and communications connections on the back of the module join connectors on the host module. Use the thumbscrew on the top of the module to lock it in place.

Host Module Empty

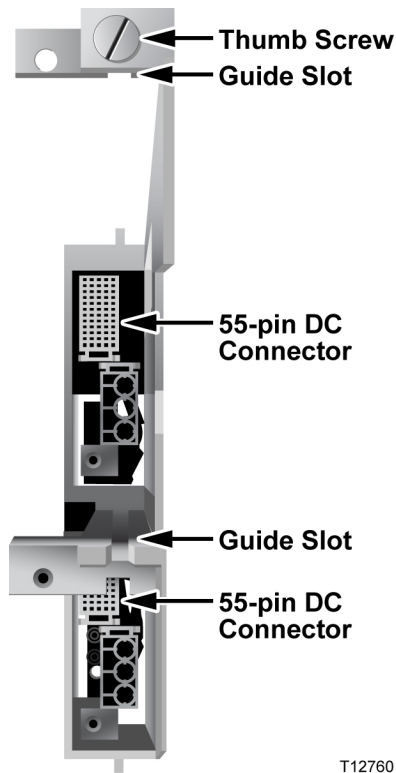

Host Module Populated



To Install the Host Module in the Chassis

Note: This procedure assumes that the chassis is mounted in a rack.

- 1 Locate the fiber guides at the bottom of the chassis and the module guide slots inside the chassis as shown in the following illustration.

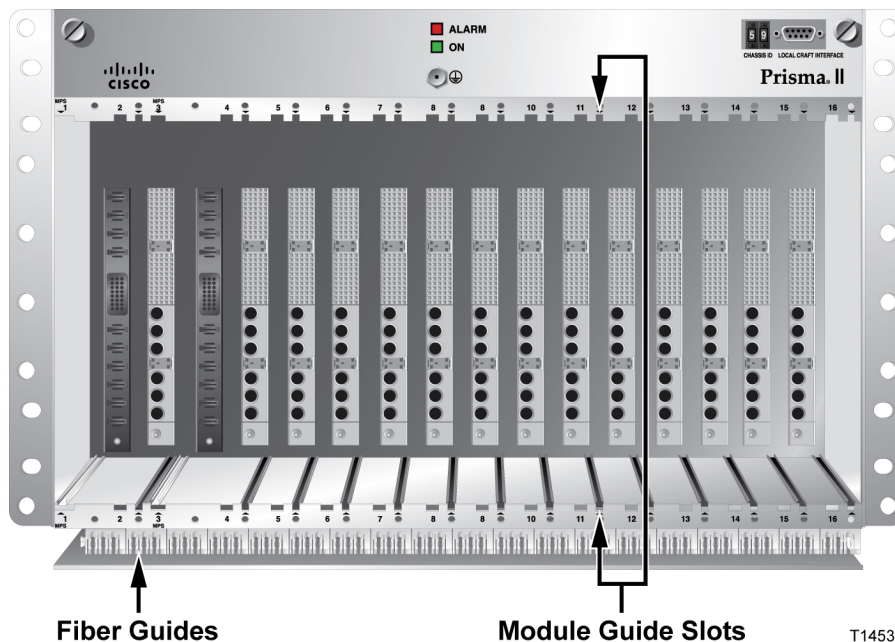

- 2 Align the ridges on the top and bottom of the host module with the guide slots on the chassis. Be careful to keep the host module level as you slide it into the chassis to avoid bending the pins on the back plane bus.
- 3 Gently slide the host module into the chassis until you feel the connections on the back of the host module join connectors on the back plane bus.

Note: Do not force or bang the host module into the chassis. If properly aligned, the host module should slide in with minimal force.

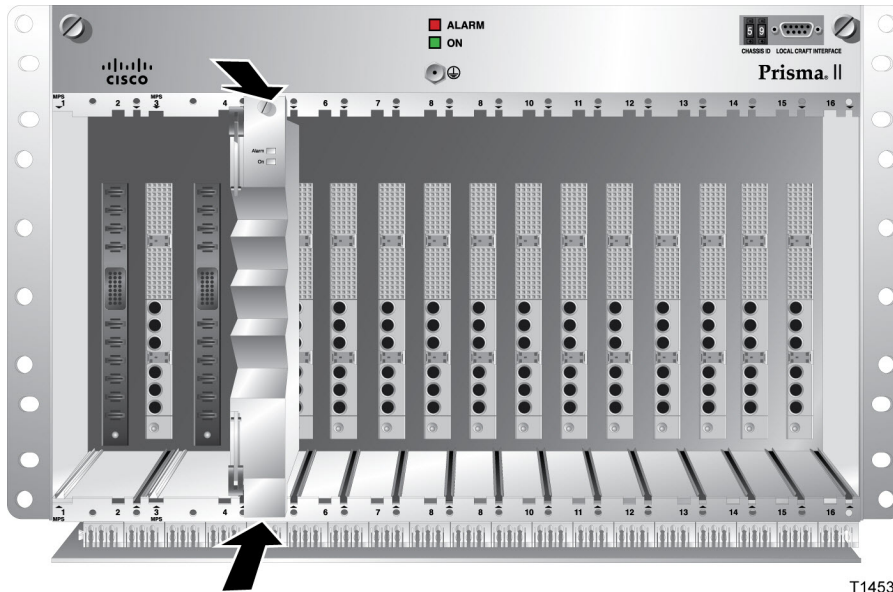

T14537

- 4 Hand-tighten the screw at the top of the host module to ensure that the first few threads engage smoothly. Use a 3/8-in. flat-blade screwdriver to secure the mounting screw. **Do not over-tighten.** The maximum torque value is 5 in-lb.
- 5 Fill any unused chassis slots with module blanks to help ensure proper cooling air flow. Blanks for high density modules are available to fill unused host module slots.

To Install the Module in a Prisma II XD Chassis

Note: This procedure assumes that the chassis is installed in a rack.



WARNING:

Avoid damage to your eyes! Do not look into any optical connector while the system is active. Even if the unit is off, there may still be hazardous optical levels present.

Complete the following steps to install the module in the chassis.



CAUTION:

Always use a screwdriver to loosen or tighten the screws holding the application modules, ICIM2-XD, fan assembly, power supply modules, DC-to-DC converters, or blanking panels in place. Do not attempt to loosen or tighten these screws solely by hand.

- 1 Locate the fiber tray at the bottom of the chassis and the application module slots inside the chassis as shown in the following illustration.

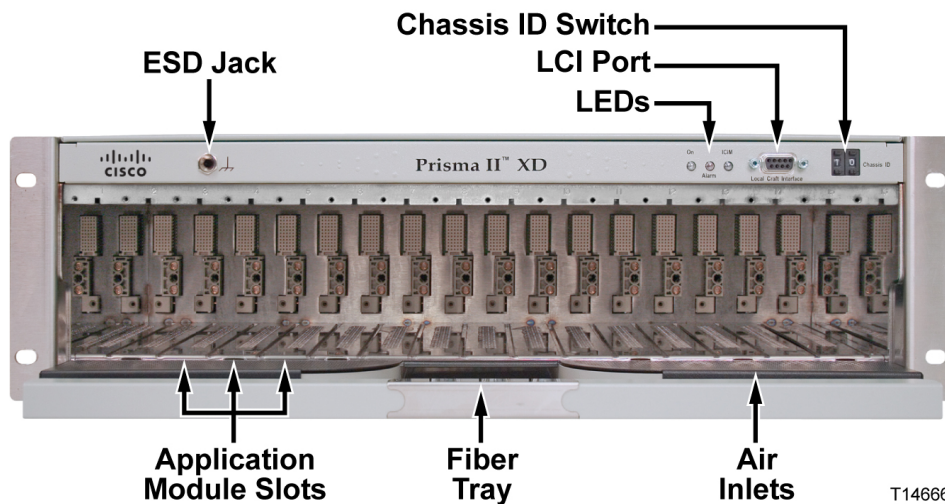

T14666

- 2 Align the ridges on the top and bottom of the module with the module guide slots located on the chassis.

- 3 Gently slide the module into the chassis until its power and communications connections join connectors on the midplane bus. *Do not force the module into the chassis.* If properly aligned, it should slide in with minimal force.

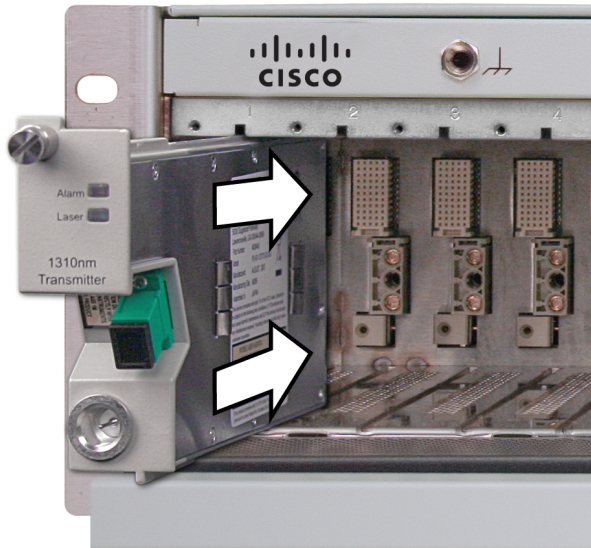

T14667

- 4 Tighten the screw at the top of the module to secure it in the chassis. Use a 3/8-in. flat-blade screwdriver to secure. *Do not over-tighten.*
- 5 Fill any unused chassis slots with module blanks to help ensure proper cooling air flow.

Routing Optical Cables

Before connecting fiber optic cables, you may need to route the fiber to the module. Use the tools and procedures in this section to route fiber as needed.

Fiber Fish Tool



WARNING:

Unterminated fiber cables and connectors may emit invisible laser radiation. Avoid direct exposure to the laser light source. Ensure that the fiber cable is terminated before "fishing."

The Fiber Fish tool that was shipped with the Prisma II Chassis is used to pull an optical cable from the rear of the chassis to the front of the chassis so the optical cables can be connected to optical connectors on the front panel of the modules.

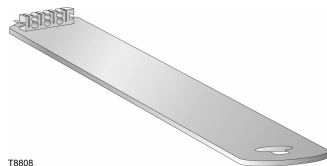

The Fiber Fish Tool Hook

At the end of the Fiber Fish tool is a small hook that allows you to hold an optical cable so that you can pull it through to the front panel of chassis.

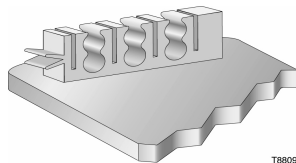

To Pull the Optical Cable to the Module

- 1 Insert the Fiber Fish tool through the slot located just above the bottom of the chassis.
- 2 At the rear of the chassis, locate the appropriate optical cable.
- 3 Insert the optical cable into the notched area of the Fiber Fish tool as shown below.

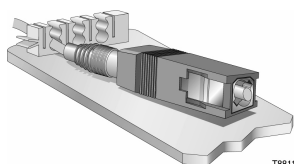

- 4 At the front of the chassis, pull the Fiber Fish tool (with cable attached) to the front of the chassis.
- 5 Disengage the optical cable from the Fiber Fish tool and attach to the appropriate connector on the desired module.

Cleaning Optical Connectors



CAUTION:

Proper operation of this equipment requires clean optical fibers. Dirty fibers will adversely affect performance. Proper cleaning is imperative.

The proper procedure for cleaning optical connectors depends on the connector type. The following describes general instructions for fiber optic cleaning. Use your company's established procedures, if any, but also consider the following.

Cleaning fiber optic connectors can help prevent interconnect problems and aid system performance. When optical connectors are disconnected or reconnected, the fiber surface can become dirty or scratched, reducing system performance.

Inspect connectors prior to mating, clean as needed, and then remove all residue. Inspect connectors after cleaning to confirm that they are clean and undamaged.

Recommended Equipment

- CLETOP or OPTIPOP ferrule cleaner (for specific connector type)
- Compressed air (also called “canned air”)
- Lint-free wipes moistened with optical-grade (99%) isopropyl alcohol
- Bulkhead swabs (for specific connector type)
- Optical connector scope with appropriate adaptor

Tips for Optimal Fiber Optic Connector Performance

- Do not connect or disconnect optical connectors with optical power present.
- Always use compressed air before cleaning the fiber optic connectors and when cleaning connector end caps.
- Always install or leave end caps on connectors when they are not in use.
- If you have any degraded signal problems, clean the fiber optic connector.
- Advance a clean portion of the ferrule cleaner reel for each cleaning.
- Turn off optical power before making or breaking optical connections to avoid microscopic damage to fiber mating surfaces.

To Clean Optical Connectors



Warning:

- **Avoid personal injury! Use of controls, adjustments, or procedures other than those specified herein may result in hazardous radiation exposure.**
- **Avoid personal injury! The laser light source on this equipment (if a transmitter) or the fiber cables connected to this equipment emit invisible laser radiation.**
- **Avoid personal injury! Viewing the laser output (if a transmitter) or fiber cable with optical instruments (such as eye loupes, magnifiers, or microscopes) may pose an eye hazard.**

- Do not apply power to this equipment if the fiber is unmated or unterminated.
- Do not stare into an unmated fiber or at any mirror-like surface that could reflect light emitted from an unterminated fiber.
- Use safety-approved optical fiber cable to maintain compliance with applicable laser safety requirements.

Important: Ensure that no optical power is present prior to this procedure.

- 1 Turn optical power off to the connector.
- 2 Using an optical connector scope, inspect the connector for scratches, burns, or other signs of damage.

Note: If the connector is damaged, replace the jumper.

- 3 If the connector requires cleaning, swipe it across the face of the appropriate ferrule cleaner several times. This will remove dust and some films.

Note: You may hear a slight "squeak" while cleaning the connector, indicating that it is clean.

- 4 Inspect the connector again. If the connector requires further cleaning, clean it using 99% isopropyl alcohol and a lint-free wipe.
- 5 Swipe the connector across the face of the appropriate ferrule cleaner several more times to remove any film left by the alcohol.
- 6 Repeat all the steps above as needed until the connector is clean.

Connecting Optical Cables

To Connect Optical Cables to an HD Module

Note: This procedure assumes that the chassis is mounted in a rack.

Important: Observe laser safety precautions. Refer to the **Laser Safety** information earlier in this guide.

Complete the following steps for each optical cable to be connected to the module.

- 1 Attach one end of the optical cable to the optical output connector located on the front of the module.

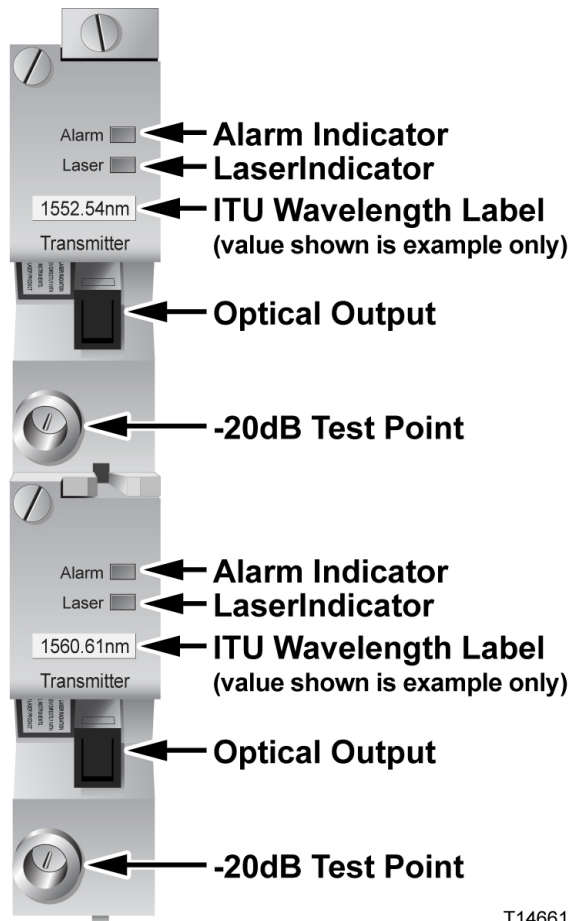

T14661

- 2 Route the other end of the optical cable to the appropriate destination.

Connecting the ICIM to Additional Chassis

Chassis-to-Chassis ICIM Connections

The Prisma II platform allows the ICIM to be located in one chassis and control modules located in several other chassis. This communication “daisy-chain” can be enabled by connecting cables to the **ICIM IN** and **ICIM OUT** connectors located on the connector interface panel of the chassis. This connection is required if an ICIM in one chassis is to communicate with or control any module located in a separate chassis.

Note: An ICIM can control a maximum of 140 modules. Depending on your application, this is typically 6 or 7 chassis to a rack. Do not exceed these limits.

ICIM IN and ICIM OUT Connectors

Every Prisma II standard and Prisma II XD chassis has a DB9 **ICIM IN** and a DB9 **ICIM OUT** connector for the purpose of chassis-to-chassis ICIM connections. **ICIM IN** is a female connector and **ICIM OUT** is a male connector.

Prisma II Standard Chassis

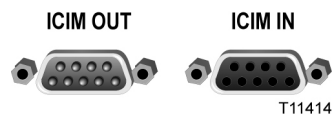

Prisma II XD Chassis

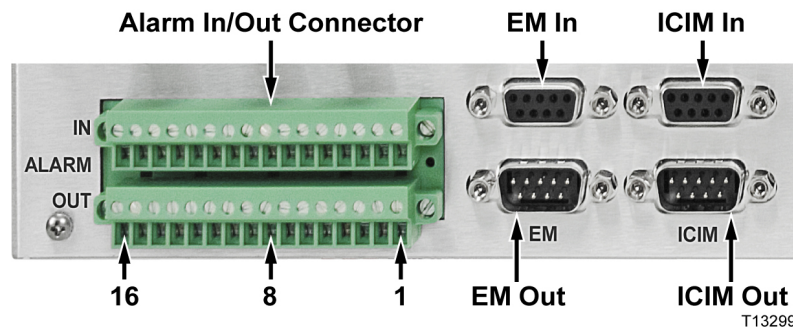

ICIM IN and ICIM OUT Cables

The cable required for both **ICIM IN** and **ICIM OUT** connections is a shielded 9-wire serial extension cable, DB9 Female to DB9 Male. This cable can be purchased locally or from the factory. The chassis data sheet lists the

part number for a 6-foot DB9 Female to DB9 Male serial extension cable. The connectors are a serial 9-pin D-shell (EIA 574/232).

To Connect Chassis-to-Chassis ICIM IN and ICIM OUT Ports

- 1 Connect the serial extension cable from the **ICIM OUT** of the chassis containing the ICIM to the **ICIM IN** connector of the second chassis.
- 2 Connect a serial extension cable from the **ICIM OUT** of the second chassis to the **ICIM IN** of the third chassis.
- 3 Continue this daisy-chain connection until all chassis are connected.
- 4 Connect an **ICIM OUT** terminator, part number 4013014, to the **ICIM OUT** connector on the last chassis in the daisy-chain connection. The **ICIM OUT** terminator ships with the ICIM.

Important:

- All chassis connected in the daisy-chain must be powered and have a fan tray installed. A chassis connected in the daisy-chain that is not powered or has no fan tray installed will cause faulty operation of the ICIM.
- All chassis connected in this daisy-chain must have a unique chassis ID number.
- If the **ICIM OUT** terminator that ships with the ICIM is not installed on the last chassis of a daisy-chain connection, faulty communication with the ICIM may occur.

External Alarm Connections

Master/Slave Operation

All Prisma II modules ship from the factory configured as a master. The LCI, or the ICIM can be used to reconfigure a module as a slave or as redundant. The Prisma II Chassis allows for local hard-wired redundancy by using the **ALARM IN** and **ALARM OUT** connectors located on the connector interface panel. A pair of modules can be configured so that if the master fails, the slave takes over by using the **ALARM IN** and **ALARM OUT** connectors.

ALARMS IN and ALARMS OUT Connectors

Every Prisma II standard and Prisma II XD chassis provides connectors for external alarms to and from each module slot. These alarm connectors are located on the chassis connector panel and are labeled **ALARMS IN** and **ALARMS OUT**.

For detailed information on **ALARM IN** and **ALARM OUT** connectors, see the *Prisma II Chassis Installation and Operation Guide*, part number 713375 or the *Prisma II™ XD Platform System Guide*, part number 4021339.

When a critical alarm occurs in a Master module, the Master turns off and the Slave (redundant module) is enabled. To make this happen, the pin representing the Master module slot in the **ALARM OUT** connector must be externally wired to the pin representing the Slave module slot in the **ALARM IN** connector. After wiring these contacts, take care to ensure that the Master and Slave modules are not moved to other slots. Otherwise, the **ALARM IN** and **ALARM OUT** connectors will need to be rewired to the appropriate pins.

Note:

- Any device configured as Single or Master ignores its **ALARM IN** contacts.
- To verify proper wiring and redundant configuration, simply unplug the Master module and observe that the Slave module turns on.

ALARMS IN and ALARMS OUT Connector Illustration

Prisma II Standard Chassis

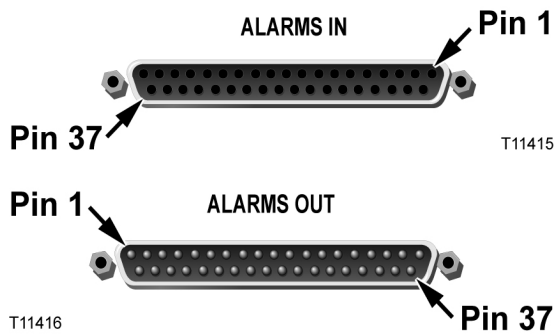

Prisma II XD Chassis

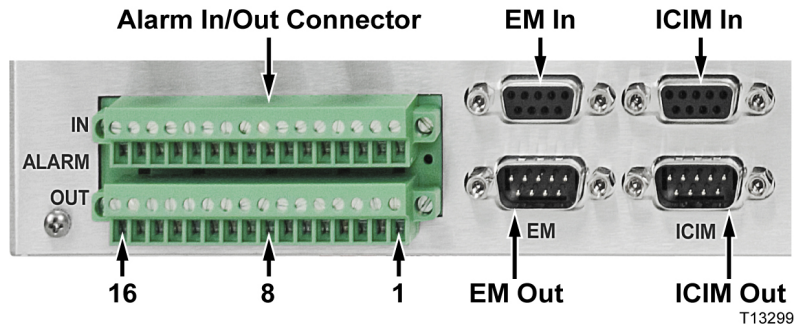

Master/Slave Illustration

Inter-module connections are made on the back of the chassis using "ALARMS IN" and "ALARMS OUT" connectors.

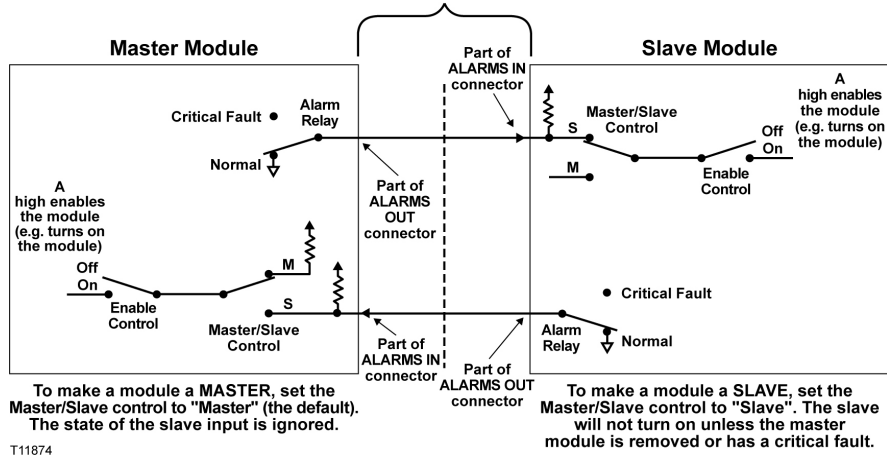

Redundancy Interface Panel

The Prisma II Redundancy Interface Panel is an accessory to the Prisma II platform. It is intended to be used with the master/slave feature and the contact closure alarm feature of the Prisma II platform.

The Prisma II Redundancy Interface Panel serves as an extension to the two DB-37 connectors labeled **ALARM IN** and **ALARM OUT** on the connector interface panel of the chassis. The terminals on the redundancy interface panel are extensions of pins on the **ALARMS OUT** and **ALARMS IN** connectors on the chassis.

For additional information, see the *Prisma II Chassis Installation and Operation Guide*, part number 713375.

Prisma II Redundancy Interface Panel Illustrations

Front Panel

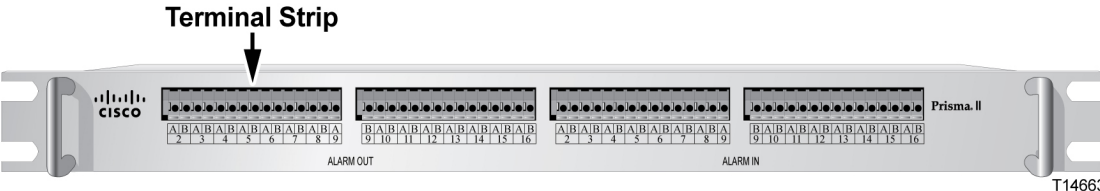

Back Panel

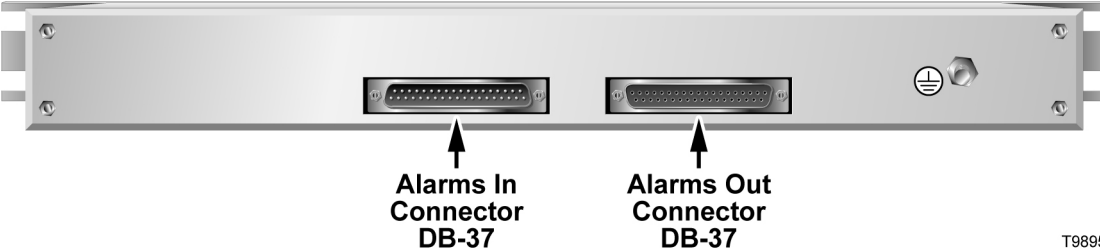

Close-up of Front Panel Terminal Strips

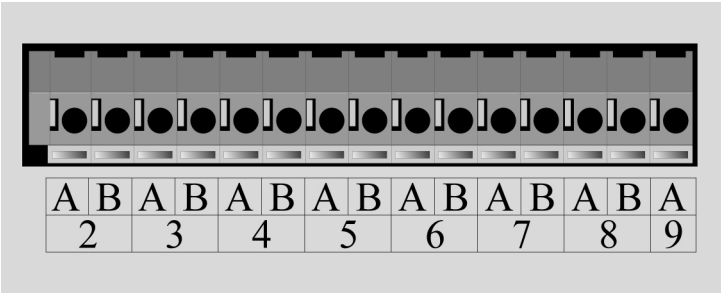

3

Operation Using the ICIM

Introduction

The procedures in this chapter apply if you are using the Prisma II ICIM2 front-panel interface to configure and operate the module. For information on using CLI commands or the ICIM Web Interface to configure and operate the module, see the *Prisma II Platform Remote User Interface Guide, System Release 2.03*.

Scope of This Chapter

Included in this chapter are descriptions of the ICIM2 front-panel keyboard and liquid crystal display (LCD), and detailed procedures on how to use front-panel menus to configure the module.

Note: You must use CLI commands or the ICIM Web Interface to configure and operate the module when using the ICIM2-XD. For details, see the *Prisma II Platform Remote User Interface Guide, System Release 2.03*.

In This Chapter

- ICIM Introduction..... **Error! Bookmark not defined.**
- ICIM2 Front Panel..... **Error! Bookmark not defined.**
- ICIM Password..... **Error! Bookmark not defined.**
- Operating the ICIM..... **Error! Bookmark not defined.**
- Checking the Operating Status using the ICIM..... **Error! Bookmark not defined.**
- Configuring the Module using the ICIM..... **Error! Bookmark not defined.**
- Checking Module Alarms using the ICIM..... **Error! Bookmark not defined.**
- Checking Manufacturing Data using the ICIM..... **Error! Bookmark not defined.**
- Saving the Configuration using the ICIM..... **Error! Bookmark not defined.**
- Adjusting Alarm Thresholds..... **Error! Bookmark not defined.**

ICIM Introduction

Laser Warning



WARNING:

- **Avoid personal injury! Use of controls, adjustments, or procedures other than those specified herein may result in hazardous radiation exposure.**
 - **Avoid personal injury! The laser light source on this equipment (if a transmitter) or the fiber cables connected to this equipment emit invisible laser radiation. Avoid direct exposure to the laser light source.**
 - **Avoid personal injury! Viewing the laser output (if a transmitter) or fiber cable with optical instruments (such as eye loupes, magnifiers, or microscopes) may pose an eye hazard.**
- Do not apply power to this equipment if the fiber is unmated or unterminated.
 - Do not stare into an unmated fiber or at any mirror-like surface that could reflect light emitted from an unterminated fiber.
 - Do not view an activated fiber with optical instruments such as eye loupes, magnifiers, or microscopes.
 - Use safety-approved optical fiber cable to maintain compliance with applicable laser safety requirements.
 - Even if the unit is off, there may still be hazardous optical levels present.

ICIM Function

The ICIM functions as the module-user interface.

The ICIM allows local module configuration and status monitoring for up to 140 modules located in multiple chassis. The ICIM features easy-to-use software that can be navigated locally on models equipped with a front-panel keypad and LCD display.

The ICIM can also be navigated remotely using CLI commands or the ICIM Web Interface. For additional information, see the *Prisma II Platform Remote User Interface Guide, System Release 2.03*, part number 4025477.

Important:

- Do not operate any Prisma II Chassis without a fan tray installed properly. If a fan tray is not installed in the Prisma II Chassis, the ICIM will not communicate with any of the modules in that chassis.

- All chassis connected in a daisy-chain must be powered and have a fan tray installed. A chassis that is connected but is either not powered, or does not have a fan tray installed will cause faulty operation of the ICIM.
- All chassis connected in this daisy-chain must have a unique chassis identification (ID) number.
- The last chassis in the daisy-chain must have a terminator installed in the ICIM OUT connector. Otherwise, faulty communication with the ICIM may occur.

ICIM Block Diagram

A block diagram representing the ICIM2 or ICIM2-XD is shown below.

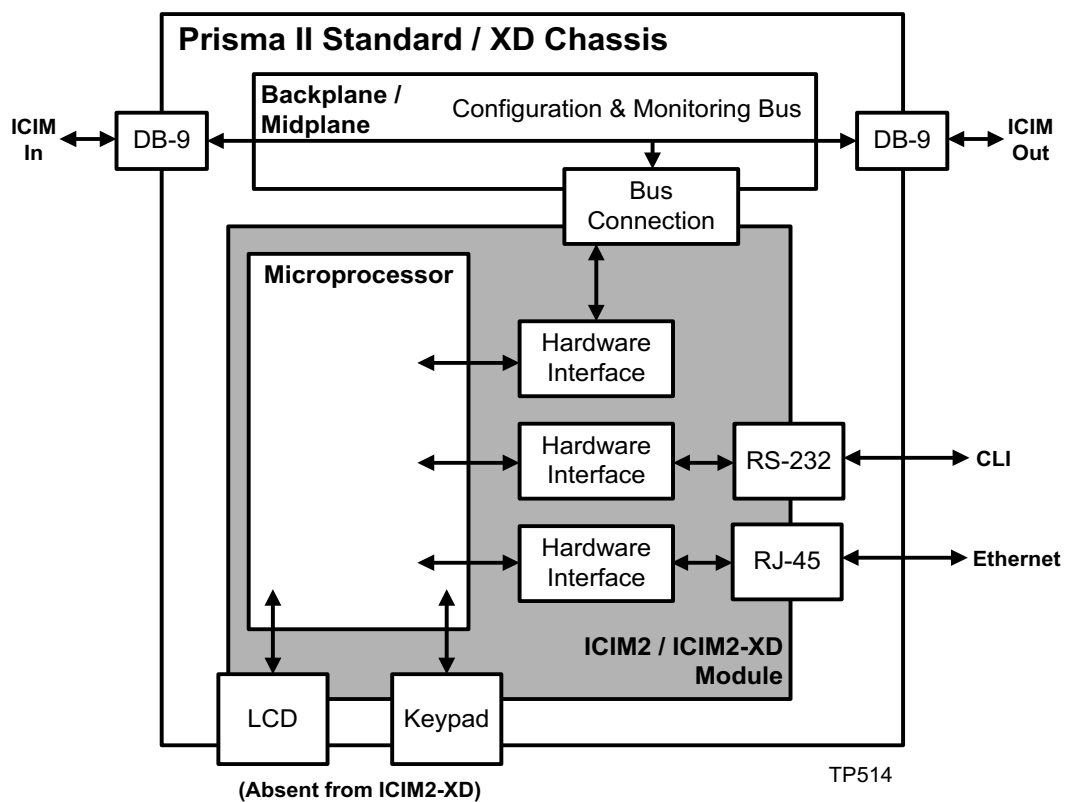

ICIM2 Front Panel

ICIM2 Illustration (Front Panel)

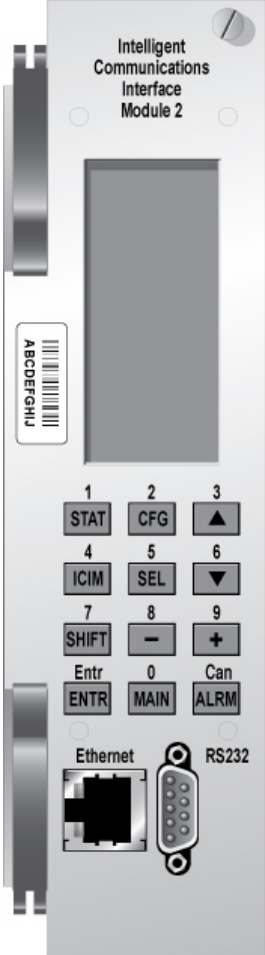

ICIM2 Front Panel Features

Part	Function
LCD screen	Displays the ICIM2 menus, alarms, and status information.
12-key numeric keypad	Used to navigate the ICIM2 menus and configure the application modules.
Ethernet connector	Directly connects the ICIM2 to an IP network. The ICIM2 Ethernet port is suitable for connection to intra-building wiring, non-exposed wiring or cabling only.
Yellow LED on Ethernet connector	Glows when the Ethernet port is operating in full duplex. Blinks when collisions occur on the Ethernet port.
Green LED on Ethernet connector	Glows when a link is established on the Ethernet port. Blinks during data activity on the Ethernet port.
RS232 connector	Used to connect a PC to the Prisma II system for CLI communication and setup.

ICIM LCD

The ICIM LCD is the operator’s visual link to the ICIM software. When the ICIM is installed and powered up, the **MAIN** menu is displayed on the LCD.

ICIM MAIN Menu Illustration

The ICIM MAIN menu is shown below.

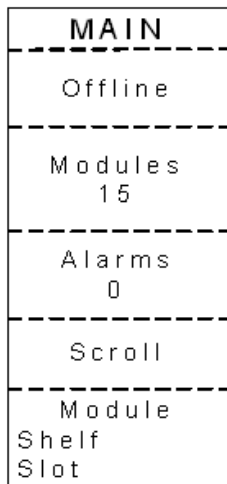

TP011

ICIM Keypad

The ICIM keypad has 12 keys that allow you to input and monitor operational parameters. Each key and a brief description of its function are shown here.

Button	Function
STAT	Displays status information for the selected module.
CFG	Displays configuration information for the selected module.
ALRM	Displays all of the parameters in alarm for a selected module.
▲	Moves the menu selection area up. Also increases numerical readings of selected configuration parameters.
▼	Moves the menu selection area down. Also decreases numerical readings of selected configuration parameters.
SEL	Selects the highlighted parameter.
ICIM	Displays ICIM module information such as firmware version, serial number, and baud rate.
SHIFT	Shifts function of a keypad button to the function or number label just above that button.
—	Decreases numerical readings of selected configuration parameters.
+	Increases numerical readings of selected configuration parameters.
ENTER	Enters input data (if valid).
MAIN	Exits the current menu and displays the MAIN ICIM menu.

ICIM Password

The ICIM allows you to send configuration commands, change alarm thresholds, and restore factory default settings in Prisma II modules. To prevent unauthorized changes to these parameters, you have the option of using a password protection system. Password authorization only applies to configurable parameters. Status and alarm information is always available on the ICIM, regardless of password implementation.

Note: The following instructions pertain to the use of the ICIM2 front-panel interface (LCD and keyboard). Remote password and other administrative functions are also supported using CLI Commands or the ICIM Web Interface. For details, see the *Prisma II Platform Remote User Interface Guide, System Release 2.03*, part number 4025477.

Password Protection System

The ICIM menu options available in the password protection system are shown here.

ICIM Menu Option	Description
User Psw	A user-settable password. <ul style="list-style-type: none"> ■ Created, entered, and changed by the system operator(s) ■ Must be exactly eight digits, using only the 0-9 number keys
Change Psw	Changes an existing user password.
Disable Psw	Disables the user password function.
SA Psw	A service password used by factory personnel only.

Important: If you only want to monitor status and alarm data, skip the password function when it appears on the ICIM menu. You can access all module status and alarm information without a password.

However, once a user password is entered, you are required to enter it every time you want to set configurable parameters to any module controlled by that ICIM. Refer to *Expired Password or Inactive Password Messages* (on page 44) and *To Enter the User Password* (on page 44).

To Access the Password Menu

The Password menu allows you to create, enter, change, or disable the user password. It also allows service personnel to use the factory default password.

- 1 Press the **ICIM** key.
- 2 Use the **▼** key to scroll down until **Password** is highlighted.
- 3 Press the **SEL** key. The Password menu appears. **User Psw** is highlighted.

MAIN	ICIM	ICIM	ICIM
Offline	Shelf 7 Slot 15	Shelf 7 Slot 15	Shelf 7 Slot 15
Modules 0	Mfg Data	Mfg Data	User Psw
Alarms 0	Password IP Setup	Password IP Setup	SA Psw
Scroll	Update Adr	Update Adr	Change Psw
Module Shelf Slot			Disable Psw

TP012

Expired Password or Inactive Password Messages

The entry of a valid password allows changes to system parameters for a period of 10 minutes. If more than 10 minutes has passed since your last keystroke, and you attempt to make any changes to system parameters, the menu displays **Psw Expired**. If, after more than 10 minutes, you attempt to disable the password the menu displays **Failed, Password Not Active**. If either of these messages is displayed, you are required to re-enter the password. To re-enter the password, follow the procedure in *To Enter the User Password* (on page 44).

To Enter the User Password

To use the user password feature, you must create and enter a password of exactly eight digits using only the 0-9 number keys.

The password remains active for 10 minutes after your last keystroke. To change configuration parameters after 10 minutes, you must re-enter your password.

Complete the following steps to enter a user password.

- 1 Access the Password menu as shown in *To Access the Password Menu* (on page 43).
- 2 Press the **SEL** key. The user password menu appears.

- 3 When **User Psw/Shift Off** appears, press the **SHIFT** key to display **Shift On**, and then enter the eight digits of your password, using the 0-9 number keys.
 - To change a digit you have just typed, use the **CAN** (Cancel) function by pressing the **ALRM** key. This deletes the last digit typed.
- 4 Press the **ENTER** key to enter the password. The ICIM display updates to show whether your password entry was accepted.
 - If the password is accepted, the word **Accepted** appears in the menu, and you are able to return to the MAIN menu.
 - If the password was rejected, the word **Rejected** appears in the menu. Reasons for a password to be rejected include:
 - Entering more than eight digits for the password.
 - Pressing keys other than the 0-9 number keys.
 - Entering an incorrect password if a valid password has been entered.

If the password is rejected, press the **SHIFT** key to return to the password menu and re-enter the password as described in step 3 above.

ICIM	ICIM	ICIM	ICIM
Shelf 0 Slot 15	Shelf 0 Slot 15	Shelf 0 Slot 15	Shelf 0 Slot 15
User Psw	User Psw *****	User Psw 1234****	User Psw 12345678
Shift Off	Shift On	Rejected Shift Off	Accepted Shift Off

TP013

To Change the User Password

If a user password has been entered, it may be changed. However, the current password must be active prior to changing it. If the current password has expired (more than 10 minutes have passed since your last keystroke), you must re-enter the current password before changing to a new one.

- 1 Access the Password menu as shown in the procedure *To Access the Password Menu* (on page 43).
- 2 Use the **▼** key to scroll down until **Change Psw** is highlighted.

- 3 Press the **SEL** key to select **Change Psw**.
- 4 When **Change Psw/Shift Off** appears, press the **SHIFT** key to display **Shift On**, and then enter the eight digits of your new password, using the 0-9 number keys.

If at any time you input a digit that is incorrect or wish to change a digit, use the **CAN** (Cancel) function by pressing the **ALRM** key to delete that digit.

- 5 Press the **ENTER** key to input the new password. As a result:
 - The ICIM updates the display to show if your password entry was accepted or rejected.
 - If the entry was accepted, you are able to return to the MAIN menu.
- 6 If the new password you entered is rejected, press the **SHIFT** key to return to the password entry menu. Clear all digits using the **CAN** (Cancel) function, then re-enter an 8-digit password using only the 0-9 number keys. Press the **ENTER** key to input the password.

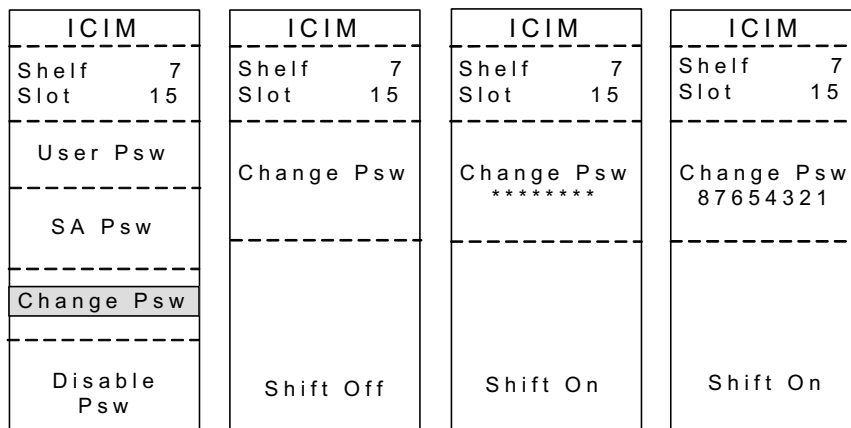

TP014

To Disable the User Password using ICIM

If a user password has been entered, you may disable it at any time. However, the current password must be active prior to disabling it. If the current password has expired (more than 10 minutes have passed since your last keystroke), you must re-enter the current password before disabling it.

- 1 Press the **ICIM** key.
- 2 Use the **▼** key to scroll down until **Password** is highlighted.
- 3 Press the **SEL** key.
- 4 Use the **▼** key to scroll down until **Disable Psw** is highlighted.
- 5 Press the **SEL** key to select **Disable Psw**.

- 6 If the current password is active, the menu displays **Password Is Now Disabled**. You can now make changes to parameters without any password.
- 7 If the current password has expired (more than 10 minutes have passed since your last keystroke), the menu displays **Failed, Password Not Active**. You must re-enter the current password and then repeat this procedure.

ICIM	ICIM	ICIM
Shelf 7 Slot 15	Shelf 7 Slot 15	Shelf 7 Slot 15
User Psw	Enter Psw 8765****	Enter Psw 87654321
SA Psw	Password Is Now Disabled	Failed, Password Not Active
Change Psw	Shift Off	Shift Off
Disable Psw		

TP015

Operating the ICIM

Using the ICIM

Once the module is installed, it runs without the aid of an operator. Unless alarms are generated or your system configuration changes, you should not need to make any adjustments to the module beyond the initial setup.

To Access the ICIM LCD Contrast

To access the ICIM LCD contrast control from the MAIN menu, press the **ICIM** key. Use the **+** key to increase or the **-** key to decrease ICIM display contrast.

ICIM MAIN Menu

A few seconds after power-up, the MAIN menu (shown below) appears. Press the **SEL** key to select the specific option.

Display	Description
Offline	Indicates network communication status with the ICIM.
Modules	Indicates the number of modules in the ICIM domain.
Alarms	Displays the number of modules that are in alarm. Selecting this option allows scrolling through all modules in alarm condition.
Scroll	Allows scrolling through all modules in the ICIM domain.
Module Shelf Slot	Allows selection of any specific module in the ICIM domain.

ICIM MAIN Menu Illustration

The ICIM MAIN menu is shown below.

MAIN
Offline
Modules 15
Alarms 0
Scroll
Module Shelf Slot

TP011

Prisma II ICIM Menu

To display the ICIM menu, press the **ICIM** key. The ICIM menu (shown below) appears. Press the **SEL** key to select the specific option.

Display	Description
Shelf Slot	Displays the location of the ICIM module.
Mfg Data	Displays manufacturing data about the ICIM.
Password	Allows you to enter, change, or disable a system password. See Using the ICIM Password earlier in this chapter.
Update Adr	If the Chassis ID number switch has been changed, you must highlight the Update Adr menu and press the SEL key for the ICIM to recognize the change.

<table border="1"> <tr><td>ICIM</td></tr> <tr><td>Shelf 0 Slot 15</td></tr> <tr><td>Mfg Data</td></tr> <tr><td>Password</td></tr> <tr><td>Update Adr</td></tr> </table>	ICIM	Shelf 0 Slot 15	Mfg Data	Password	Update Adr	<table border="1"> <tr><td>ICIM</td></tr> <tr><td>Shelf 0 Slot 15</td></tr> <tr><td>Mfg Data</td></tr> <tr><td>Password</td></tr> <tr><td>Update Adr</td></tr> </table>	ICIM	Shelf 0 Slot 15	Mfg Data	Password	Update Adr	<table border="1"> <tr><td>ICIM</td></tr> <tr><td>Shelf 0 Slot 15</td></tr> <tr><td>Mfg Data</td></tr> <tr><td>Password</td></tr> <tr><td>Update Adr</td></tr> </table>	ICIM	Shelf 0 Slot 15	Mfg Data	Password	Update Adr
ICIM																	
Shelf 0 Slot 15																	
Mfg Data																	
Password																	
Update Adr																	
ICIM																	
Shelf 0 Slot 15																	
Mfg Data																	
Password																	
Update Adr																	
ICIM																	
Shelf 0 Slot 15																	
Mfg Data																	
Password																	
Update Adr																	

TP016

Prisma II MAIN Menu and ICIM Menu Structure

Pressing the **MAIN** key initiates the MAIN software menu. Pressing the **ICIM** key initiates the ICIM software menu. The MAIN and ICIM software structures are shown below.

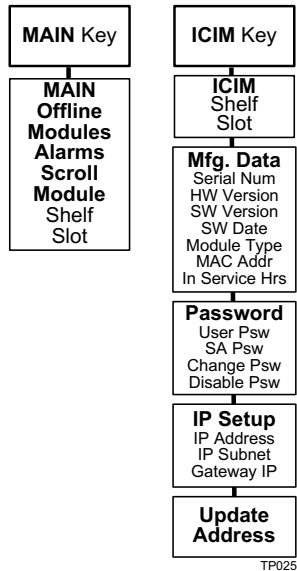

Prisma II High Density Long Reach Multiwave Transmitter Software Menus



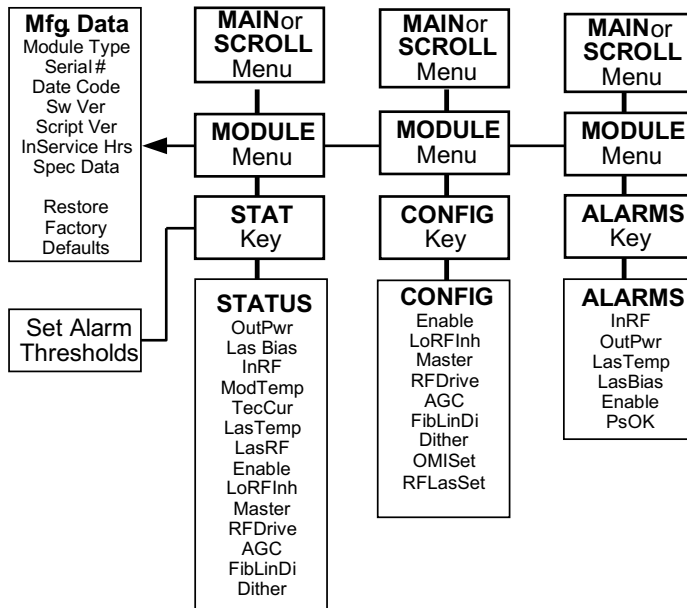









From the MAIN or SCROLL menus, you can navigate to the MODULE menu. From the MODULE menu, press the **STAT**, **CFG**, or **ALRM** key to display the desired parameter menu.



Checking the Operating Status using the ICIM

To Check the Operating Status using ICIM

You can use the ICIM to check the status of all operating parameters of this module. All status information is displayed on the ICIM LCD.

- 1 At the MAIN menu, press the  key to highlight the **Shelf** and **Slot** fields.
- 2 Press the  key to address the **Shelf** number. Then press the  key or the  key to scroll to the number of the desired shelf.
- 3 Press the  key. The **Slot** field is highlighted.
- 4 Press the  key or the  key to scroll to the number of the desired slot.
- 5 Press the  key. The **MODULE** menu appears on the ICIM LCD.
- 6 Press the  key.
- 7 Press the  key or the  key to scroll through the monitored parameters until you find the parameter of interest.
- 8 Check the status of the desired parameter or select other parameters to monitor. When finished, press the  key to return to the **MAIN** menu.

STATUS Menus

Press the  key to select the STATUS menu. Typical STATUS menus are shown below.

STATUS	STATUS	STATUS	STATUS
Shelf 5 Slot 12	Shelf 5 Slot 12	Shelf 5 Slot 12	Shelf 5 Slot 12
P2HD1.215TXM	P2HD1.215TXM	P2HD1.215TXM	P2HD1.215TXM
OutPwr 10.2 dBm	InRF 0.5 dB	TecCur 125 mA	LasRF -9.890 dB
LasBias 97 mA ▲ ▼	ModTemp 30.3 degC ▲ ▼	LasTemp 20.5 degC ▲ ▼	Enable ON ▲ ▼















Chapter 3 Operation Using the ICIM

Note: For details on all operating status parameters, see *Module Parameter Descriptions* (on page 93).



Configuring the Module using the ICIM

To Configure Parameters using the ICIM

You can use the ICIM to configure the parameters of this module.

- 1 From the **MAIN** menu, press the  key to highlight the **Shelf** and **Slot** fields.
- 2 Press the  key to address the **Shelf** number. Then press the  key or the  key to scroll to the number of the desired shelf.
- 3 Press the  key. The **Slot** field is highlighted.
- 4 Press the  key or the  keys to scroll to the number of the desired slot.
- 5 Press the  key. The **MODULE** menu appears on the ICIM LCD.
- 6 To configure the module, press the  key.
- 7 Press the  key or the  key to scroll through the configurable controls until you find the parameter of interest.
- 8 Press the  key to select the highlighted control.
- 9 Press the  key or the  key to activate or change the value of the selected control.
- 10 Press the  key to save the changes and return to the **MAIN** menu.

CONFIG Menus

When the **CONFIG** menu is selected, the **Shelf** number field is highlighted. The shelf and slot number fields may only be incremented with the  key or the  key. The  key highlights the **Slot** number field. Once you exit the slot field, the Up and Down arrows will scroll through the parameters that are specific to this module.

Sample **CONFIG** menus are shown below.

Chapter 3 Operation Using the ICIM

CONFIG	CONFIG	CONFIG	CONFIG
Shelf 5 Slot 16	Shelf 5 Slot 16	Shelf 5 Slot 16	Shelf 5 Slot 16
P2HD1.215TXM	P2HD1.215TXM	P2HD1.215TXM	P2HD1.215TXM
Enable LoRFInh Master RFDrive AGC	Enable ON	LoRFInh ON	Master

Note: For details on all configurable parameters, see *Module Parameter Descriptions* (on page 93).













Checking Module Alarms using the ICIM

To Check Alarms using ICIM



If the red ALARM LED on the front panel is blinking, a minor alarm condition is indicated. If the ALARM LED on the front panel is illuminated, a critical alarm condition is indicated.

Alarms fall into one of the following categories.

- Major low
- Minor low
- Minor high
- Major high

- 1 From the MAIN menu, press the  key to highlight the **Shelf** and **Slot** fields.
- 2 Press the  key to address the **Shelf** number. Then press the  key or the  keys to scroll to the number of the desired shelf.
- 3 Press the  key. The **Slot** field is highlighted.
- 4 Press the  key or the  key to scroll to the number of the desired slot.
- 5 Press the  key. The **MODULE** menu appears on the ICIM LCD.
- 6 Press the  key. Module alarm conditions appear on the ICIM LCD.
- 7 Use the  key or the  key to scroll through alarm conditions until the desired alarm is displayed.
- 8 Monitor the alarm condition(s). Take appropriate action. Verify that all settings and thresholds relating to the alarm indication are set correctly to rule out an unintended alarm.
- 9 When finished, press the  key to return to the MAIN menu.

ALARMS Menus

When a module **ALARMS** menu is selected, press the  key or the  key to scroll through alarms. Some typical **ALARMS** menus are shown below.

ALARMS	ALARMS	ALARMS	ALARMS
Shelf 5	Shelf 5	Shelf 5	Shelf 5
Slot 16	Slot 16	Slot 16	Slot 16
P2HD1.215TXM	P2HD1.215TXM	P2HD1.215TXM	P2HD1.215TXM
InRF MinL	OutPwr MinH	LasBias MajL	LasTemp MajH
▲ ▼	▲ ▼	▲ ▼	▲ ▼

Note: For details on all alarm parameters, see *Module Parameter Descriptions* (on page 93).

To Set Adjustable Alarm Thresholds using the ICIM

You can use the ICIM to change the adjustable alarm thresholds of this module from their factory default values.

- 1 At the MODULE menu, press the **STAT** key. The STATUS menu appears on the ICIM LCD.
- 2 Press the **SEL** key. The alarm thresholds previously set are displayed. If the label **n/a** is displayed, you cannot configure that alarm threshold. Press the **▼** key to highlight the alarm threshold for the next parameter.
- 3 When the threshold that you wish to set is highlighted, press the **ENTER** key.
- 4 Press the **▼** key or the **▲** key to change the increment size.
- 5 Press the **+** key or the **-** key to adjust the alarm threshold.

Note: Press the Cancel (**ALRM**) key to return to the previous menu.

- 6 Press the **ENTER** key to save the changes. The message **Data Saved** appears on the ICIM LCD.
- 7 When finished, press the **MAIN** key to return to the MAIN menu.

Alarm Threshold Menus

Some typical alarm threshold menus are shown below.

STATUS		STATUS		STATUS		STATUS	
Shelf	0	Shelf	0	Shelf	0	Shelf	0
Slot	6	Slot	6	Slot	6	Slot	6
P2HD1.215TXM		P2HD1.215TXM		P2HD1.215TXM		P2HD1.215TXM	
LasTemp		LasBias		InRF		Enable	
MajH	n / a	MajH	n / a	MajH	7 . 500		n / a
MinH	n / a	MinH	n / a	MinH	5 . 000		n / a
MinL	n / a	MinL	n / a	MinL	- 5 . 000		n / a
MajL	n / a	MajL	n / a	MajL	- 9 . 00		n / a

TP348









Note: For details on all alarm thresholds, see *Module Parameter Descriptions* (on page 93).





Checking Manufacturing Data using the ICIM

To Check Manufacturing Data

You can display the manufacturing data for this module on the ICIM LCD.

Complete the following steps to access the manufacturing data.



- 1 From the MAIN menu, press the  key to highlight the **Shelf** and **Slot** fields.
- 2 Press the  key to address the **Shelf** number. Then press the  key or the  key to scroll to the number of the desired shelf.
- 3 Press the  key. The **Slot** field is highlighted.
- 4 Press the  key or the  key to scroll to the number of the desired slot.
- 5 Press the  key. The MODULE menu for this module will be selected, as shown on the left below. Press the  key to enter the start of the MFG. DATA menus, as shown on the right below.

MODULE	MFG . DATA
Shelf <input type="text" value="5"/> Slot <input type="text" value="10"/>	Shelf <input type="text" value="5"/> Slot <input type="text" value="10"/>
P2HD1.215TXM	P2HD1.215TXM
Alarms	Module Type
Mfg . Data  	1067  

TP349

Use the  and  keys to scroll through the manufacturing data.

MFG. DATA Menu

When the **MFG. DATA** menu is selected, the  key or the  key allows you to scroll through the manufacturing parameters specific to this module. Sample **MFG. DATA** menus are shown below.

MFG .DATA	MFG .DATA	MFG .DATA	MFG .DATA
Shelf 5 Slot 10	Shelf 5 Slot 10	Shelf 5 Slot 10	Shelf 5 Slot 10
P2HD1.215TXM	P2HD1.215TXM	P2HD1.215TXM	P2HD1.215TXM
Module Type 1067	Serial # MMAACUG Date Code B 06	Sw Ver 172 Script Ver 1	In Service Hours 100
▲ ▼	▲ ▼	▲ ▼	▲ ▼

TP950

Note: For details on all manufacturing data parameters, see *Module Parameter Descriptions* (on page 93).

Saving the Configuration using the ICIM

To Save the Current Configuration

- 1 After you have changed a parameter or entered data, press the **ENTER** key to save the changes and return to the MAIN menu.
- 2 If you do not save your changes for two minutes, or if you press the **SHIFT** **CAN** keys at the same time, changes are aborted and the display returns to the MAIN menu.

Configuration Complete

If no alarms are indicated after using the ICIM to configure this module to your system specifications, no further action is necessary. The module operates without further input. Alarms, changes in operating parameters, electrical power fluctuations, or changes in system design may be cause for additional action.

Adjusting Alarm Thresholds

To Adjust Alarm Thresholds

This method for adjusting alarm thresholds lets you choose any valid increment size and adjust the alarm threshold to any valid value.

You can use the ICIM to change the adjustable alarm thresholds of this module from their factory default values.

- 1 At the MODULE menu, press the **STAT** key. The STATUS menu appears on the ICIM LCD.
- 2 Press the **SEL** key. The alarm thresholds previously set are displayed. If the label **n/a** is displayed, you cannot configure that alarm threshold. Press the **▼** key to highlight the alarm threshold for the next parameter.
- 3 When the threshold that you wish to set is highlighted, press the **ENTER** key.
- 4 Press the **▼** key or the **▲** key to change the increment size.
- 5 Press the **+** key or the **-** key to adjust the alarm threshold.

Note: Press the Cancel (**ALRM**) key to return to the previous menu.

- 6 Press the **ENTER** key to save the changes. The message **Data Saved** appears on the ICIM LCD.
- 7 When finished, press the **MAIN** key to return to the MAIN menu.

4

Operation Using LCI

Introduction

This chapter provides instructions for installing and using the LCI. This chapter applies if you are using the LCI to operate a module.

In This Chapter

- LCI Introduction **Error! Bookmark not defined.**
- System Requirements **Error! Bookmark not defined.**
- Installing LCI..... **Error! Bookmark not defined.**
- Connecting Your Computer to the Chassis**Error! Bookmark not defined**
- Starting LCI Software **Error! Bookmark not defined.**
- LCI Module Tree..... **Error! Bookmark not defined.**
- Accessing Module Details **Error! Bookmark not defined.**
- Checking the Operating Status **Error! Bookmark not defined.**
- Configuring the Module using LCI.. **Error! Bookmark not defined.**
- Checking the Module Alarms using LCI**Error! Bookmark not defined.**
- Modifying Module Alarm Limits using LCI**Error! Bookmark not define**
- Checking Manufacturing Data using LCI**Error! Bookmark not defined.**

LCI Introduction

Laser Warning



WARNING:

- **Avoid personal injury! Use of controls, adjustments, or procedures other than those specified herein may result in hazardous radiation exposure.**
 - **Avoid personal injury! The laser light source on this equipment (if a transmitter) or the fiber cables connected to this equipment emit invisible laser radiation. Avoid direct exposure to the laser light source.**
 - **Avoid personal injury! Viewing the laser output (if a transmitter) or fiber cable with optical instruments (such as eye loupes, magnifiers, or microscopes) may pose an eye hazard.**
- Do not apply power to this equipment if the fiber is unmated or unterminated.
 - Do not stare into an unmated fiber or at any mirror-like surface that could reflect light emitted from an unterminated fiber.
 - Do not view an activated fiber with optical instruments such as eye loupes, magnifiers, or microscopes.
 - Use safety-approved optical fiber cable to maintain compliance with applicable laser safety requirements.
 - Even if the unit is off, there may still be hazardous optical levels present.

LCI Function

LCI is software that functions as a user interface for the Prisma II platform. LCI is installed on a computer, which is then connected to a Prisma II Chassis. Using LCI, you can configure and monitor the modules in the chassis to which the computer is connected.

Important: Do not operate any Prisma II Chassis without a fan tray installed. If a fan tray is not installed in the Prisma II Chassis, the LCI will not communicate with any of the power supplies in that chassis.

System Requirements

You will need the following computer software and hardware to run LCI.

Computer Requirements

- Pentium II 300 MHz processor or equivalent
- 128 MB RAM
- 10 MB available hard drive space
- CD-ROM Drive
- Windows 95 or later operating system software

Cable Requirements

The required cable is a standard serial extension cable, DB9 Female to DB9 Male. This cable can be purchased locally or ordered from the factory as part number 180143. The connectors are a serial 9-pin D-shell (EIA 574/232).

Installing LCI

This section describes how to install your LCI software.

To Install the LCI Software

Complete the following steps to install the LCI software.

- 1 Obtain the LCI installation program from Cisco Services and copy the program file to your Windows desktop.
- 2 Launch the LCI installation program. The Welcome screen appears as shown in the following illustration.

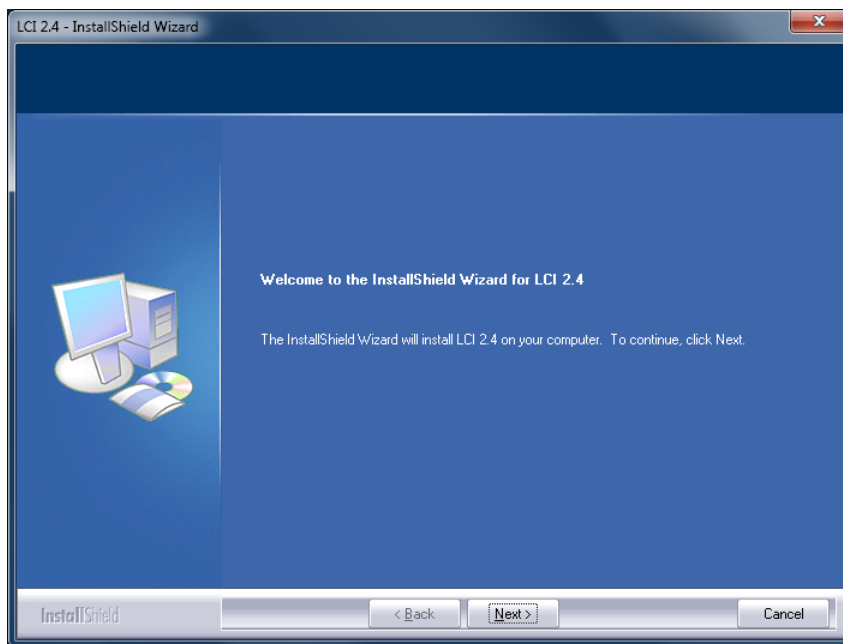

- 3 Click **Next** to continue with the installation process. The Ready to Install the Program screen appears as shown in the following illustration.

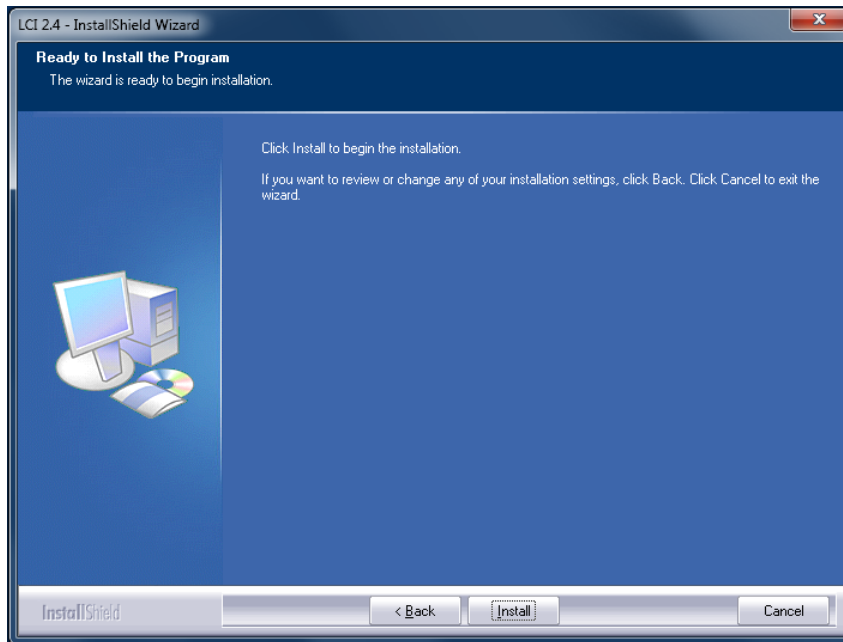

- 4 Click **Install** to begin installation. After a moment, the Setup Status screen appears, displaying a progress indicator as shown in the following illustration.

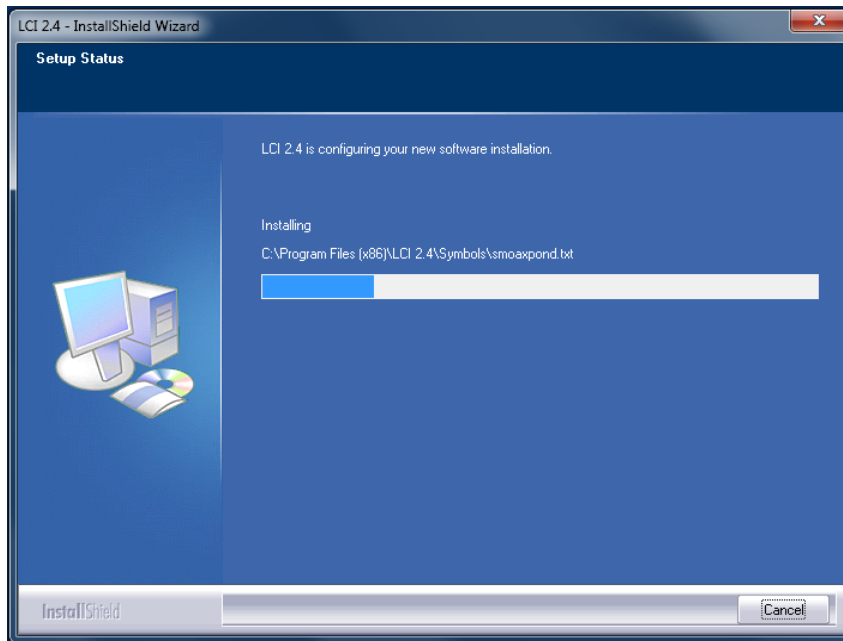

- 5 When finished, the "wizard" asks if you want to install the Silicon Labs driver, which is required when using LCI with a node product.
 - If you are using LCI with a node product, choose the **Launch** option, click **Next**, and follow steps of the wizard to install the driver.
 - If you are not using LCI with a node product, choose the **Exit Installation** option and then click **Next**.

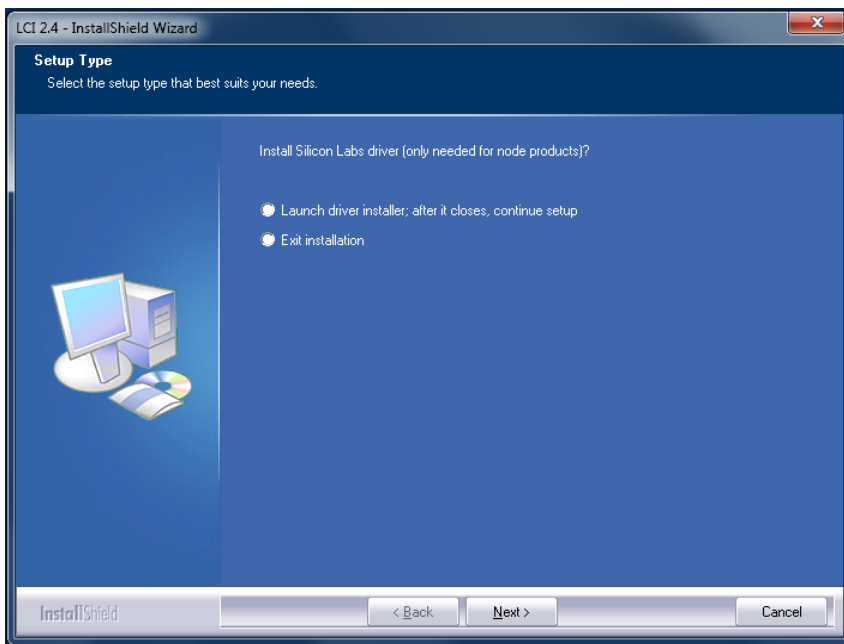

- 6 When finished, the InstallShield Wizard Complete screen appears as shown in the following illustration.

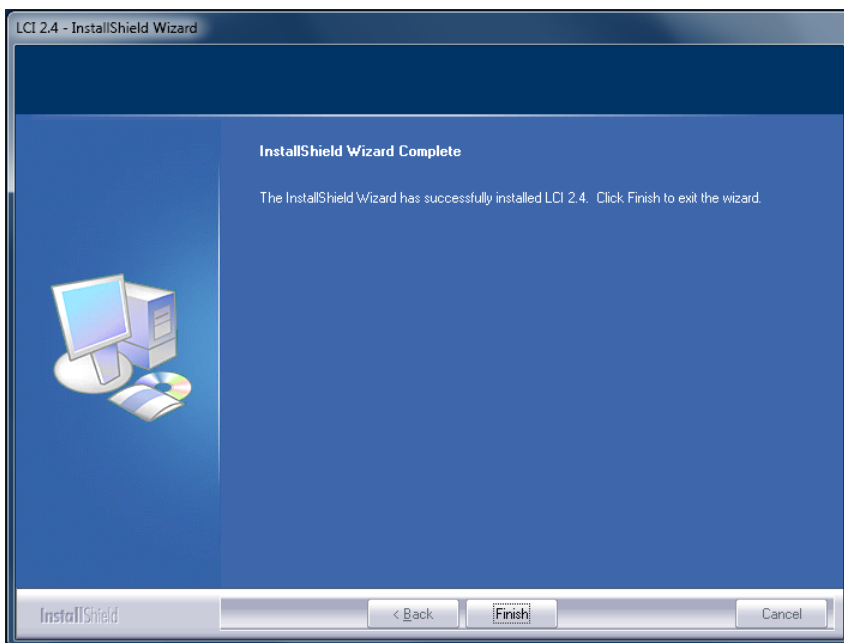

- 7 Click **Finish** to exit the Install wizard. An LCI shortcut is placed on your Windows desktop as shown in the following illustration.



The LCI software is now ready to use.

Connecting Your Computer to the Chassis

Before you start LCI, you must first connect your computer to the chassis that contains the module(s) you want to check.

Important:

- LCI only communicates with modules installed in the chassis to which your computer is connected. To check other modules, you must connect your computer to the chassis in which they are installed.
- If LCI does not communicate with a module in the chassis to which your computer is connected, it may be necessary to update the LCI application.

To Connect a Computer to the Chassis

Complete the following steps to connect your computer to the chassis:

- 1 Plug one end of a 9-pin RS-232 serial extension cable into your computer.
- 2 Plug the other end of the cable into the LCI port, labeled **Local Craft Interface**.

Standard Prisma II Chassis

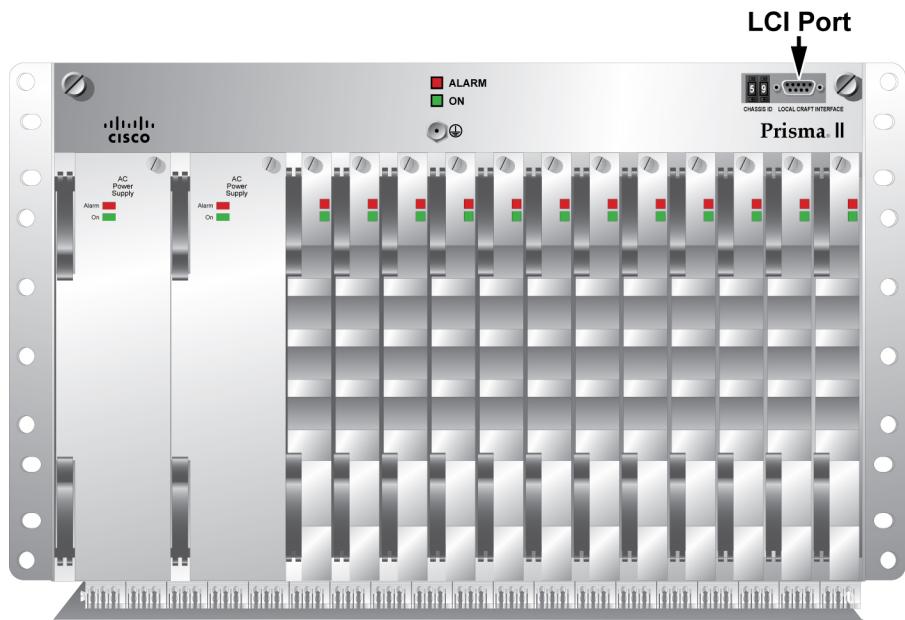

T14536

Prisma II XD Chassis (Top Right Corner Detail)

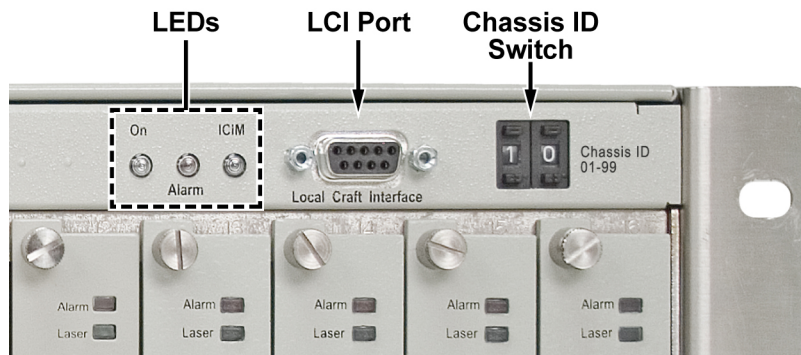

T13297

Starting LCI Software

When you start LCI, it polls the module(s) located in the chassis to which your computer is attached. For each module it finds, LCI does the following:

- Represents the module in the module tree of the main LCI window
- Makes the polling information available so you can check and configure various parameters

Important: Your computer must be connected to the chassis before you start LCI. For instructions, refer to *Connecting Your Computer to the Chassis* (on page 70).

To Start LCI Software

Complete the following steps to start the LCI software:

- 1 Double-click the LCI icon on your Windows desktop.



Result: The LCI Detect Configuration window appears as shown below.

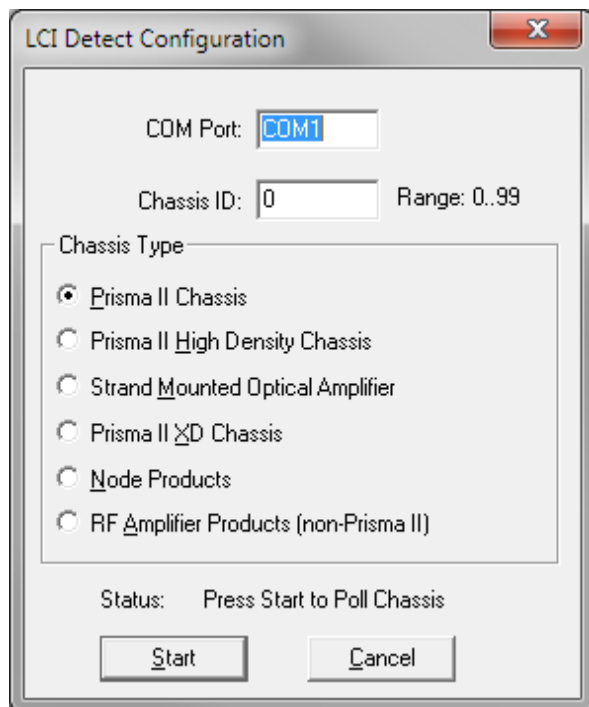

- 2 In the LCI Detect Configuration window, select the appropriate COM port, chassis ID, and chassis type, and then click **Start**.

Result: LCI polls the modules in the chassis, and when finished, displays a Refresh Complete message.

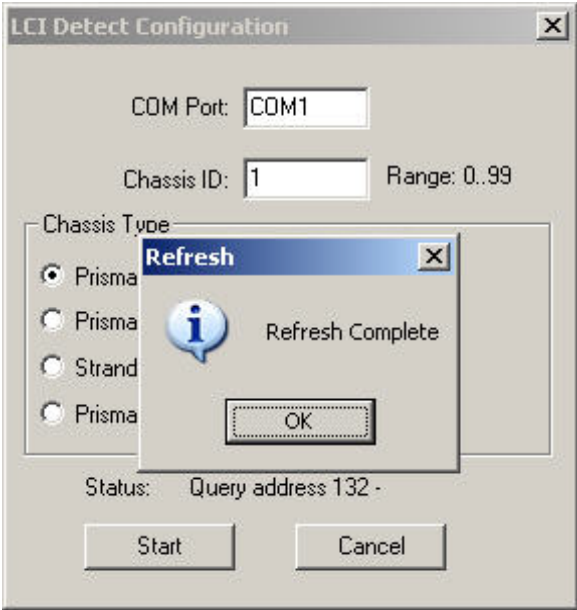

3 Click OK to continue with LCI startup.

Result: The main LCI window appears as shown in the example below.

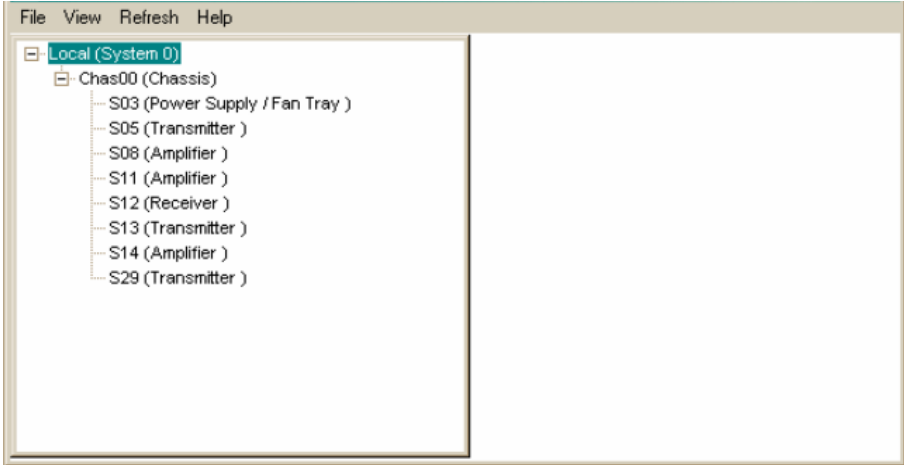

LCI Module Tree

Introduction

The LCI main window contains a tree that represents your system in a hierarchical manner.



Module Tree Levels

In the illustration above, the module tree represents a computer connected to a chassis that contains ten modules. The three tree levels are described in the following table.

Module Tree Level	Description
Local (System 0)	Computer being used
Chas00 (Chassis)	Chassis to which the computer is connected
Sxx (Module name)	<p>Module(s) located within the chassis. Each module is of the format <i>chassis slot location (module name)</i>.</p> <p>Slot location is from 17-32 if the module is located at the lower slot of the host module. The slot number will be the regular upper slot number plus 16.</p> <p>Note: In the example module tree, S29 (Transmitter) represents a forward transmitter that's located in slot 29 of the chassis.</p>

Accessing Module Details

The Module Details window displays information about module parameters, alarms, and status. You can access this window from the module tree using one of several methods:

- Double-click the chassis to display a graphic image of the chassis, and then double-click the module in the graphic.
- Right-click the chassis in the module tree to display a context menu, and then choose **Open** from the menu.
- Right-click the module in the module tree to display a context menu, and then select **Details** from the menu.
- Double-click the module in the module tree.

The procedures in this chapter show the module right-click method. In practice, use the method that you find most convenient.

Module Details Window

The following illustrations show the Module Details window for the HD-LRMW Transmitter.

Prisma II 1.2 GHz iWDM LRMW Transmitter

Parameters

	Present Value	Present Status	Nominal Value	Minor-Alarm Low-Limit	Minor-Alarm High-Limit	Major-Alarm Low-Limit	Major-Alarm High-Limit	
Laser Temperature	24.7	Normal	24.8	-5	5	-15	15	deg-C
Laser Bias	134.4	Normal	134.5	-10	10	-20	20	A
RF Input	-99.0	Normal	0.0	-6.0	5.0	-50.0	7.5	dB
Optical Output Power	12.4	Normal	12.5	-0.5	0.5	-1.0	0.9	dBm

Alarms

- Summary Status Normal
- Communication Status Normal
- Power Supply Status Normal
- Laser Enabled Status Normal

Status

- Module Temperature 27.7 Deg-C
- TEC Current -94.9 A
- SBS 2GHz PLL Lock
- ITU Channel 32
- Laser RF -0.9
- SBS 2GHz Power 86.5

Controls

- Enable Laser On
- Low RF Inhibit On
- Master Master
- RF Drive Setting 0.0 dB
- AGC Mode Off
- OMI Level Setting 0.0 dB
- Dither Off
- RF Laser Setting Off
- Fiber Link Distance 10.0 km

Properties

- Devtype Revision 1.02
- Name S113
- Graphic
- Service Name
- Symbol
- Device Location
- Alias
- Notify Set A
- Notify Set B
- M&C-Scan On-Scan
- Maintenance Mode Normal
- Poll Counter 60
- Script
- Comm Alarm Threshold 1
- Comm Quality %
- Address 113
- Port COM1
- Generic Name Transmitter
- Description Prisma II 1.2 GHz iWDM LRMW Transmitter
- Software Revision 0.03.03
- Script Version N/A
- Serial Number KKAARYFA
- Time Of Service 852 Hrs
- Day Code F15
- Module Type 1067

Checking the Operating Status

To Check the Operating Status using LCI

Using the LCI, you can check the status of all module operating parameters.

- 1 In the module tree, right-click the module, and then click **Details**.

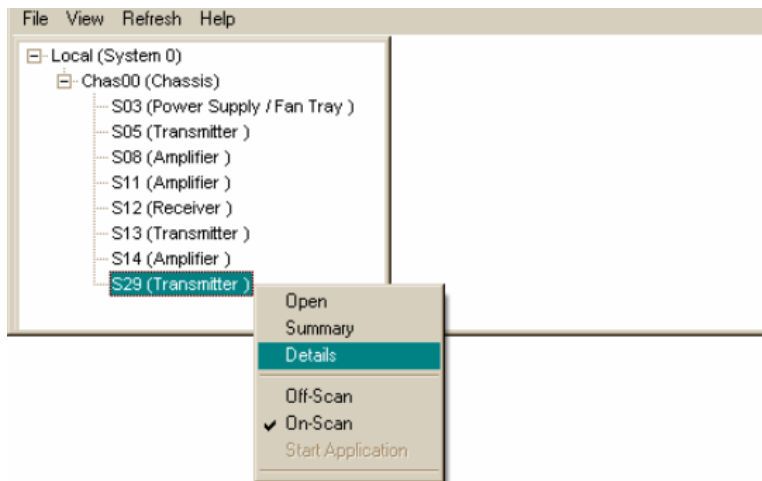

The Module Details window appears as shown in the following example. The monitored parameters are displayed under **Parameters** and **Status**.

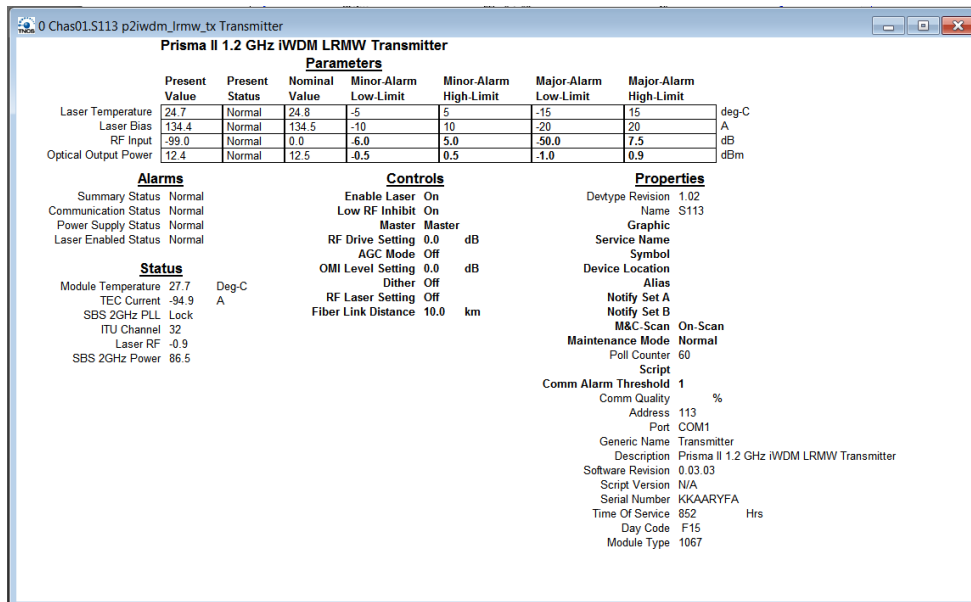

2 Check the operating parameters.

Note: For details on all operating status parameters, see *Module Parameter Descriptions* (on page 93).

Configuring the Module using LCI

To Configure Parameters using LCI

Using LCI, you can configure any module parameters that allow for such changes.

- 1 In the module tree, right-click the module, and then click **Details**.

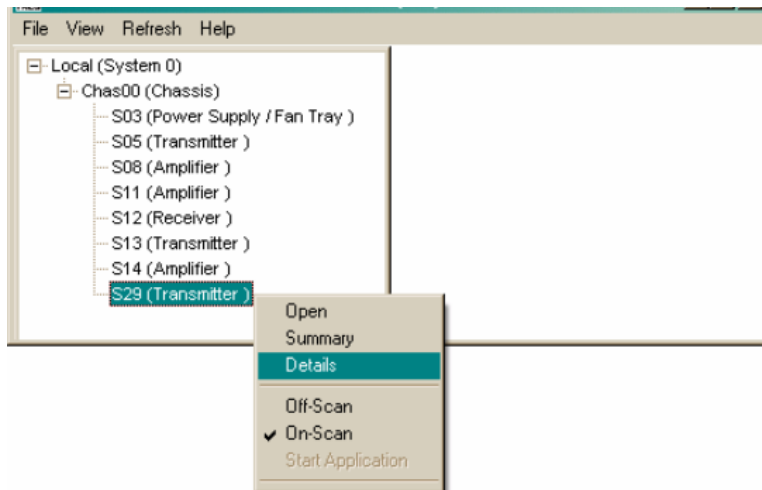

The Module Details window appears as shown in the following example.

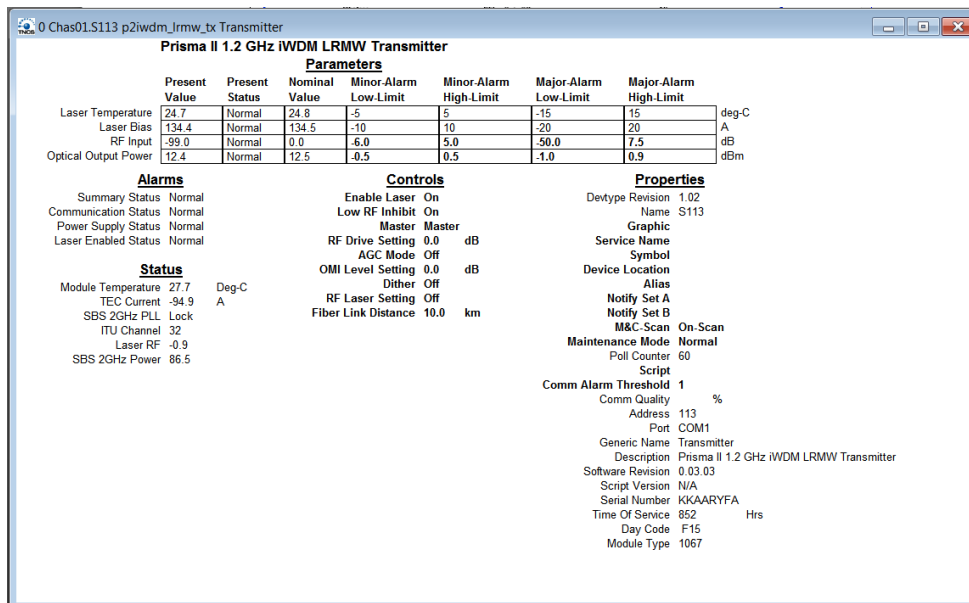

- 2 Under **Controls**, double-click the parameter you want to configure. The Change Value Dialog box appears. This example shows the dialog box for the RF Drive Setting parameter.

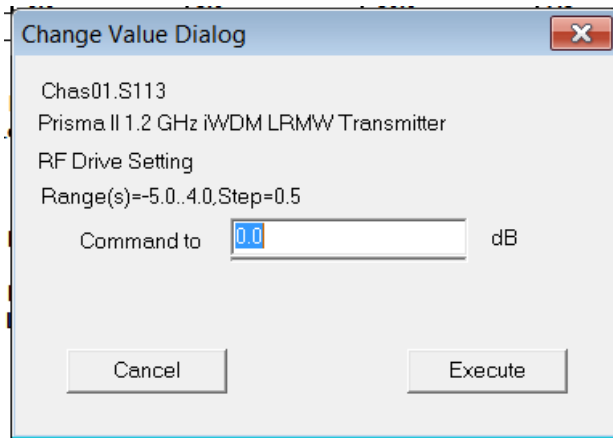

- 3 Depending on the parameter you chose, select or type a new value.
- 4 Click **Execute**. The new value appears next to the parameter.

Note: For details on all configurable parameters, see *Module Parameter Descriptions* (on page 93).

Checking the Module Alarms using LCI

Using LCI, you can check the alarm status of various parameters. Alarms limits fall into one of the following categories.

- Major low
- Minor low
- Minor high
- Major high

To Check Alarms using LCI

Right-click the module, and then click **Details**.

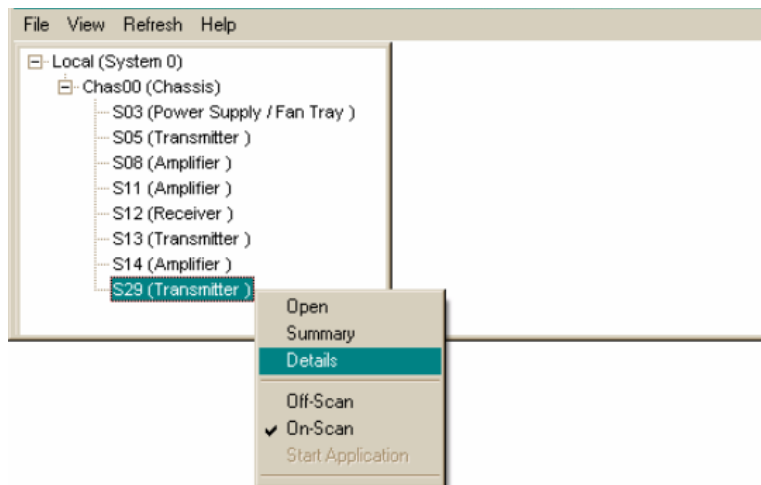

The Module Details window appears as shown in the following example. The alarms are shown under **Parameters** and **Alarms**.

Checking the Module Alarms using LCI

0 Chas01.S113 p2iwdm_lrmw_tx Transmitter

Prisma II 1.2 GHz IWDM LRMW Transmitter

	Parameters		Nominal Value	Minor-Alarm Low-Limit	Minor-Alarm High-Limit	Major-Alarm Low-Limit	Major-Alarm High-Limit	
	Present Value	Present Status						
Laser Temperature	24.7	Normal	24.8	-5	5	-15	15	deg-C
Laser Bias	134.4	Normal	134.5	-10	10	-20	20	A
RF Input	-99.0	Normal	0.0	-6.0	5.0	-50.0	7.5	dB
Optical Output Power	12.4	Normal	12.5	-0.5	0.5	-1.0	0.9	dBm

Alarms	Controls	Properties
Summary Status Normal	Enable Laser On	Devtype Revision 1.02
Communication Status Normal	Low RF Inhibit On	Name S113
Power Supply Status Normal	Master Master	Graphic
Laser Enabled Status Normal	RF Drive Setting 0.0 dB	Service Name
	AGC Mode Off	Symbol
	OMI Level Setting 0.0 dB	Device Location
	Dither Off	Alias
Status	RF Laser Setting Off	Notify Set A
Module Temperature 27.7 Deg-C	Fiber Link Distance 10.0 km	Notify Set B
TEC Current -94.9 A		M&C-Scan On-Scan
SBS 2GHz PLL Lock		Maintenance Mode Normal
ITU Channel 32		Poll Counter 60
Laser RF -0.9		Script
SBS 2GHz Power 86.5		Comm Alarm Threshold 1
		Comm Quality %
		Address 113
		Port COM1
		Generic Name Transmitter
		Description Prisma II 1.2 GHz IWDM LRMW Transmitter
		Software Revision 0.03.03
		Script Version N/A
		Serial Number KKAARYFA
		Time Of Service 852 Hrs
		Day Code F15
		Module Type 1067

Note: For details on all alarm parameters, see *Module Parameter Descriptions* (on page 93).

Modifying Module Alarm Limits using LCI

To Modify Alarm Limits using LCI

Using LCI, you can modify alarm limits for parameters that allow for such changes.

- 1 In the module tree, right-click the module, and then click **Details**.

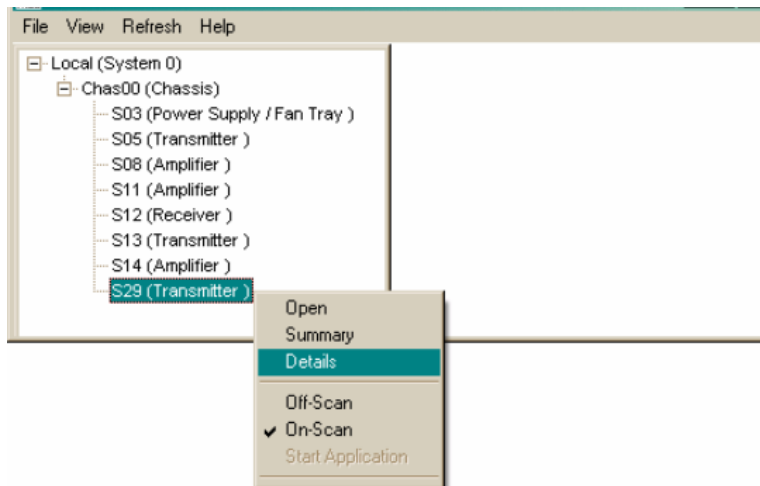

The Module Details window appears as shown in the following example. The alarm limits are shown under **Parameters**.

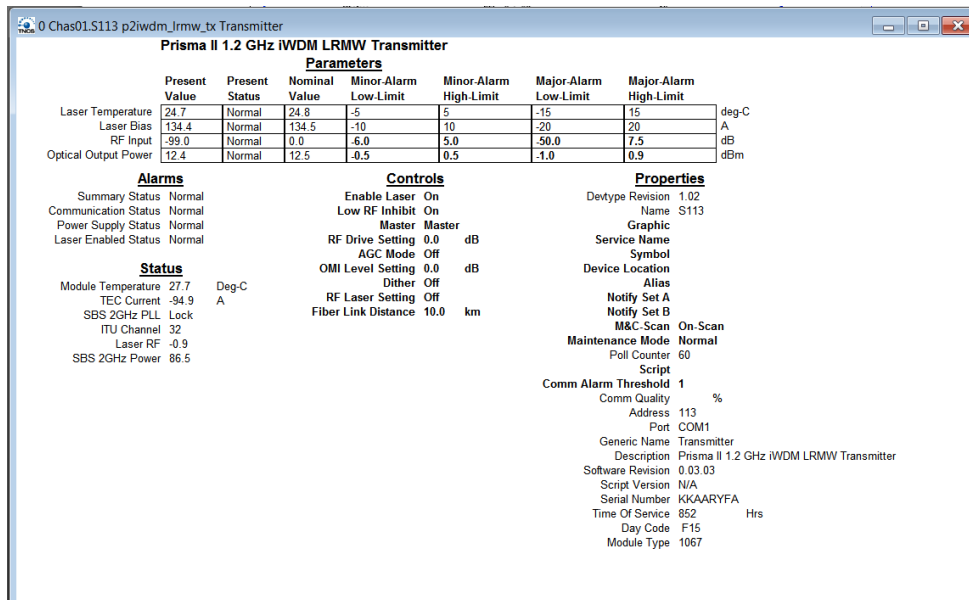

- 2 Double-click the limit you want to change.
- 3 The Change Value dialog box appears as shown below. This example shows the dialog box for the Optical Output Minor High Limit parameter.

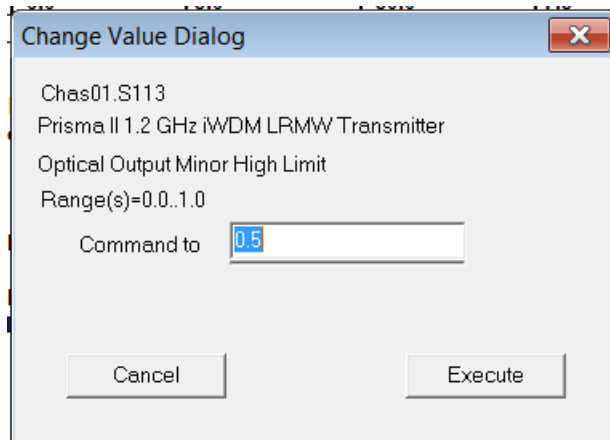

4 In the **Command to** box, type the value to use for the limit.

Click **Execute**. The new value appears in the alarm limit column.

Note: For details on all alarm limits, see *Module Parameter Descriptions* (on page 93).

Checking Manufacturing Data using LCI

To Check Manufacturing Data using LCI

Using LCI, you can check the manufacturing data of a module.

- 1 In the module tree, right-click the module, and then click **Details**.

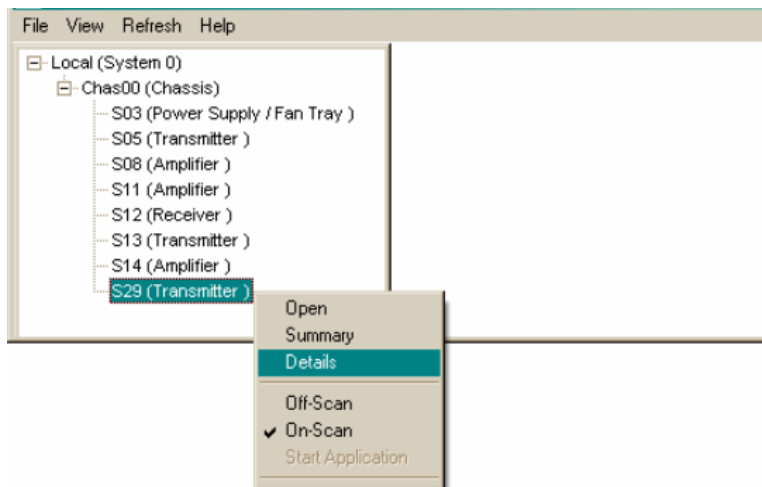

The Module Details window appears as shown below. The manufacturing data is displayed under **Properties**.

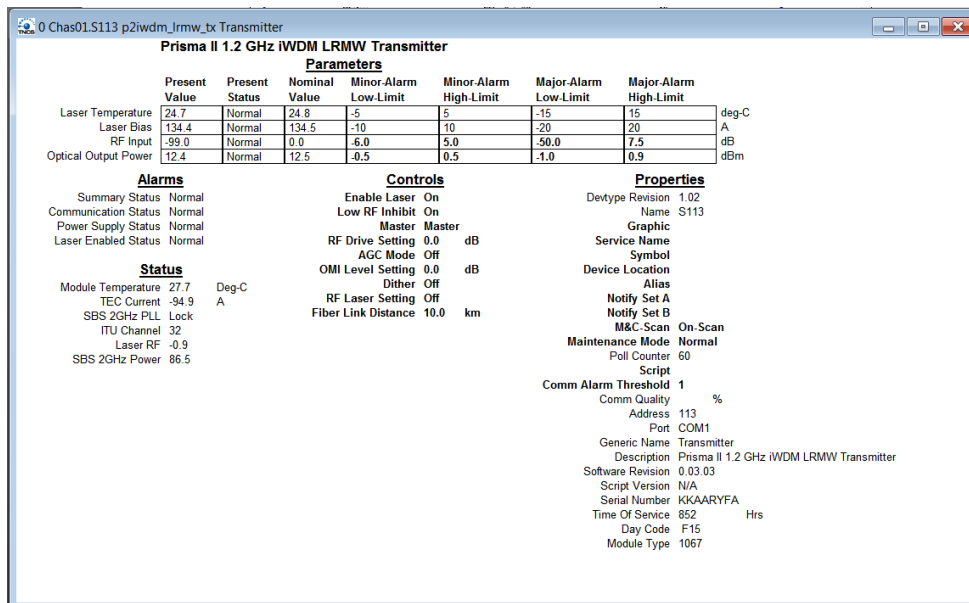

2 Proceed with viewing the manufacturing data.

Note: For details on all manufacturing data parameters, see *Module Parameter Descriptions* (on page 93).

5

Maintenance and Troubleshooting

This chapter describes the maintenance guidelines and troubleshooting procedures for this module.

Qualified Personnel

Only appropriately qualified and trained personnel should attempt to maintain or troubleshoot these products.



WARNING:

Allow only qualified personnel to install, operate, maintain, or service this product. Otherwise, personal injury or equipment damage may occur.

In This Chapter

- Maintenance **Error! Bookmark not defined.**
- General Troubleshooting Information **Error! Bookmark not defined.**
- Troubleshooting Alarm Conditions.. **Error! Bookmark not defined.**

Maintenance

The following maintenance is recommended to ensure optimal performance.

Frequency	Maintenance Required
Yearly	<ul style="list-style-type: none">■ Check all parameters and test points.■ Record data.■ Make adjustments as needed.■ Make sure all cables are mated properly.■ Inspect cables for stress and chafing.■ Make sure all retaining screws are tight.■ Replace chassis air filter, if present. Depending on office environment cleanliness and filtration, the chassis air filter may require more frequent servicing.
When needed	Carefully clean the module with a soft cloth that is dampened with mild detergent.

Maintenance Record

It may be helpful to establish a maintenance record or log for this equipment. You may want to record laser power level, laser temperature readings, laser bias current, or power supply voltages, as well as the filter change dates.

Large variations in any of the parameters above should be investigated prior to failure.

General Troubleshooting Information

This troubleshooting information describes the most common alarms and gives typical symptoms, causes, and items to check before contacting Customer Service.

Equipment Needed

You may need the following equipment to troubleshoot these modules.

- Digital voltmeter
- Fiber connector cleaning materials

Additional Assistance

If you need additional assistance, contact one of our Technical Service Centers or your local sales subsidiary. Refer to *Customer Information* (on page 91) for contact information.

Troubleshooting

Refer to *Troubleshooting Alarm Conditions* (on page 90) to identify and correct faults.



WARNING:

Avoid electric shock and damage to this product! Do not open the enclosure of this product. There are no user-serviceable parts inside. Refer servicing to qualified and skilled personnel.

Troubleshooting Alarm Conditions

Module Alarm Conditions

If the red ALARM indicator is illuminated or is blinking, check the display on the front panel to determine the cause of the alarm.

Alarm	Function	Possible Causes	Possible Solutions
LasBias	Laser Bias Current Failed	Automatic power control circuit failure.	Contact Cisco Services for assistance.
LasTemp	Laser Temperature High or Low	<ul style="list-style-type: none"> ■ Laser temperature out of specification. Laser could be faulty. ■ Chassis air filter requires changing. 	Contact Cisco Services for assistance.
PsOK	Backplane voltage status	OK	<ul style="list-style-type: none"> ■ Check module seating ■ Check chassis power supply
TxEnable	Laser Enabled status	OK	<ul style="list-style-type: none"> ■ Laser disabled ■ Check Enable and Master control settings
InRF	RF Input Power High or Low	<ul style="list-style-type: none"> ■ RF source not transmitting. ■ Faulty RF cables or connections. 	Check RF source and cables and call connections.
OutPwr	Optical Output Power High or Low	Laser could be faulty.	Contact Cisco Services for assistance.

6

Customer Information

If You Have Questions

If you have technical questions, call Cisco Services for assistance. Follow the menu options to speak with a service engineer.

Access your company's extranet site to view or order additional technical publications. For accessing instructions, contact the representative who handles your account. Check your extranet site often as the information is updated frequently.

A

Module Parameter Descriptions

Introduction

This appendix provides control, alarm, monitor, and manufacturing data parameters for this equipment.

In This Appendix

- High Density Long Reach Multiwave and Hybrid Modulation QAM Transmitter Parameters.....94

High Density Long Reach Multiwave and Hybrid Modulation QAM Transmitter Parameters

Operating Status Parameters

Parameter Name (LCI)	ICIM Abbreviation	Function	Typical Value
RF Input	InRF	Displays relative RF input power.	0 dB
Optical Output Power	OutPwr	Displays HD-LRMW optical output power	+12.5 dBm
		Displays HQT optical output power	+11.5 dBm
Module Temperature	ModTemp	Displays module temperature.	Ambient °C + 15 °C
Laser Temperature	LasTemp	Displays laser temperature.	30 °C
TEC Current	TecCur	Indicates laser thermoelectric cooler current. A positive value indicates cooling; a negative value indicates heating.	0.20 A
Laser RF Drive	LasRF	RF drive level at laser input reference to nominal setup.	-1.5 dB
Laser Enable	Enable	Laser on/off.	-
Low RF Alarm Inhibit	LoRFInh	Low RF alarm enabled/disabled.	-
Master	Master	Master or Slave operation.	-
RF Drive Level	RFDrive	RF drive level reference to nominal setup.	0.0
AGC	AGC	Automatic Gain Control.	-
Length	FibLinDi	Displays distance setting in kilometers.	50 km
Dither	Dither	Displays dither On/Off (usually Off).	-
Laser Bias	LasBias	Displays measured laser bias current.	0.270 A
SBS 2 GHz PLL	SbsStat	SBS phase lock loop (PLL) lock status (Lock or Fault).	Lock
SBS 2 GHz Power	Psbs2G	Indicates 2 GHz SBS power.	10.0 to 400.0
ITU	ITU	Displays ITU channel designator	N/A

Note:

- Monitored values may vary from module to module. The values shown above are examples only.
- ITU values are set at the factory and cannot be changed in the field.

Configurable Parameters

Parameter Name (LCI)	ICIM Abbreviation	Description	Values	Default
Laser Enable	Enable	Enables or disables amplifier operation; that is, turns the laser on or off.	ON (1) = Enabled OFF (0) = Disabled	ON (1)
Low RF Alarm Inhibit	LoRFInh	Enables or disables the "RF input low" alarm.	ON (1) = Alarm Enabled OFF (0) = Alarm Disabled	OFF (0)
AGC Mode	AGC	Turns automatic gain control on or off.	Inactive (0) Active (1)	Inactive (0)
RF Drive Setting	RFDrive	Sets the relative RF drive level into the transmitter. Only effective when AGC is off (manual gain control). This is used in conjunction with OMI set. Values from -2 dB to +2 dB allow OMI set to be adjusted and maintain specified performance	-5 dB to +4 dB	0.0 dB
OMI Level Setting	OMISet	Sets the optical modulation index level. Only effective when AGC is on. NOTE: When the AGC control is in the "on" state, the composite OMI can be changed from the factory-preset level. If the RF input power is 0dB relative to nominal, the range is [-5, +1] dB. If the RF input power is less than 0 dB relative to nominal, the maximum OMI set value is 4 dB + RF Input Level.	-5dB to +1.0 dB when RF drive setting is 0 dB	0.0 dB
Length	FibLinDi	Sets the nominal link distance for optimum performance.	0 to 100 km in 10 km steps	50 km
Dither	Dither	Turns Dither on or off. Dither may need to be turned off for high drive levels or channel loads in order to improve performance.	ON (1) OFF (0)	OFF (0)

Appendix A
Module Parameter Descriptions

Parameter Name (LCI)	ICIM Abbreviation	Description	Values	Default
Master	Master	Configures the module as master or slave: <ul style="list-style-type: none"> ■ If set to Master, the transmitter is controlled only by the Enable control above. ■ If set to Slave, the transmitter is controlled by a combination of Enable and the external input CNT_IN_1. 	ON (1) = Master OFF (0) = Slave	ON (1) = Master
RFLasSet	RFLasSet	Configures the transmitter to shut down the laser when an alarm threshold is met.	ON (1) OFF (0)	OFF (0)

Alarm Data Parameters

Num	Name ¹	Type ⁵	Value	Ref ³	Low Alarm Enable	Hi Alarm Enable	Hyst	Limits		Mult
1	LasTemp	3	LasTemp	NomLasTemp	Always	Always	1	Major Low Minor Low Minor High Major High	-15 -5 5 15	0
2	LasBias	3	LasBias	NomLasBias	Always ⁵	Always	3	Major Low Minor Low Minor High Major High	-20 -10 10 20	0
3	InRF	1	InRF	NomRFIn	Always ⁴	Always	5	Major Low Minor Low Minor High Major High	-10000 -50 50 75	-1
4	TxEnable	6	TxEnable							
5	OutPwr	1	OutPwr	NomPout	Always ⁵	Always	1	Major Low Minor Low Minor High Major High	-10 -5 5 10	-1
6	PsOk	6	PsOK		N/A	N/A				

Alarm Types

Type	Description
1	The "User" alarm. Alarm thresholds are interpreted as a positive or negative value relative to the nominal value of the alarmed variable. The threshold value is multiplied by 10^{mult} . The allowed range of values for "Mult" is -3 to +3. The alarm thresholds can be adjusted by the operator, but these alarms will not shutdown the module.
3	The "Module" alarm. Alarm threshold interpretation is the same as for Type 1 alarms, but Major Alarm will set the module into Safe State (shut it down).
5	User Boolean alarm. The state 0 means no alarm. The nominal set to 1 means, that input signal of 1 causes alarm. If nominal is 0, input value of 0 causes alarm. This alarm type does not set the unit to the safe State (Module will continue to operate).
6	Module Boolean alarm. The state 0 means no alarm. The nominal set to 1 means, that input signal of 1 causes alarm. If nominal is 0, input value of 0 causes alarm. This alarm will set the unit to the Safe State.

Manufacturing Data Parameter Examples

Parameter Name (LCI)	ICIM Abbreviation	Typical Values
Generic Name	-	Transmitter
-	Module Name	P2HD1.215TXM for HD-LRMW module P2HD1.2G15TXQP for HQT module
Description	-	Prisma II HD-LRMW Transmitter Prisma II 1.2 GHz iWDM HQT Optical Transmitter
Software Revision	Sw Ver	1.01.xx
Script Version	Script Ver	0
Serial Number	Serial #	Starts with KK
Time of Service	In Service Hours	Positive integer value
-	Spec Data	N/A
Day Code	Date Code	Alphanumeric value
Module Type	Module Type	1067 for HD-LRMW module 1062 for HQT module

Appendix A
Module Parameter Descriptions

Parameter Name (LCI)	ICIM Abbreviation	Typical Values
-	Restore Factory Defaults	Restores the module factory default configuration settings.

Note: These values may vary from module to module. The values shown above are examples only.

Glossary

ac, AC

alternating current. An electric current that reverses its direction at regularly recurring intervals.

AGC

automatic gain control. A process or means by which gain is automatically adjusted in a specified manner as a function of input level or other specified parameters.

CAN

cancel. The cancel character.

CP

constant (optical) power.

dc, DC

direct current. An electric current flowing in one direction only and substantially constant in value.

DFB laser

distributed feedback laser. An injection laser diode that has a Bragg reflection grating in the active region in order to suppress multiple longitudinal modes and enhance a single longitudinal mode.

DWDM

dense wave-division multiplexing. A method of placing multiple wavelengths of light into a single fiber that yields higher bandwidth capacity. Dense WDM indicates close spacing and more than 4 to 8 wavelengths.

EDFA

erbium doped fiber amplifier. Optical fibers doped with the rare earth element, erbium, which can amplify light in the 1550 nm region when pumped by an external light source.

EIA

Electronic Industries Alliance (formerly Electronic Industries Association). A United States

Glossary

association that provided standards for use between manufacturers and purchasers of electronic products until ceasing operations in February 2011. EIA standards continue to be recognized in the telecommunications industry.

EMC

electromagnetic compatibility. A measure of equipment tolerance to external electromagnetic fields.

EMT

externally-modulated transmitter.

ESD

electrostatic discharge. Discharge of stored static electricity that can damage electronic equipment and impair electrical circuitry, resulting in complete or intermittent failures.

FHEDA

forward headend driver amplifier.

HD

high density.

HEDA

headend driver amplifier.

I/O

input/output.

ICIM

intelligent communications interface module.

IP

Internet Protocol. A standard that was originally developed by the United States Department of Defense to support the internetworking of dissimilar computers across a network. IP is perhaps the most important of the protocols on which the Internet is based. It is the standard that describes software that keeps track of the internetwork addresses for different nodes, routes, and outgoing/incoming messages on a network. Some examples of IP applications include email, chat, and Web browsers.

iWDM

interoperable wave-division multiplexing. The iWDM plan comprises 16 ITU compatible wavelengths in the C band from ITU 21 through 62, and is generally accepted in the industry

for use in multi-wavelength systems.

LCD

liquid crystal display. A display medium made of liquid crystal. Liquid crystal's reflectance changes when an electric field is applied. Commonly used in monitors, televisions, cell phones, digital watches, etc.

LCI

local craft interface.

LED

light-emitting diode. An electronic device that lights up when electricity passes through it.

MIB

Management Information Base. SNMP collects management information from devices on the network and records the information in a management information base. The MIB information includes device features, data throughput statistics, traffic overloads, and errors.

nm

nanometer. One billionth of a meter.

NMS

network management system. A software system designed specifically to monitor a network and to facilitate troubleshooting.

OMI

optical modulation index, expressed in decimal or percentage notation.

PLL

phase lock loop. An electronic servo system controlling an oscillator to maintain a constant phase angle relative to a reference signal.

QAM

quadrature amplitude modulation. An amplitude and phase modulation technique for representing digital information and transmitting that data with minimal bandwidth. Both phase and amplitude of carrier waves are altered to represent the binary code. By manipulating two factors, more discrete digital states are possible and therefore larger binary schemes can be represented.

Glossary

RF

radio frequency. The frequency in the portion of the electromagnetic spectrum that is above the audio frequencies and below the infrared frequencies, used in radio transmission systems.

RMA

return material authorization. A form used to return products.

RT

remote terminal. Remote equipment of a supervisory system.

RX

receive or receiver.

SBS

stimulated Brillouin scattering. The easiest fiber nonlinearity to trigger. When a powerful light wave travels through a fiber, it interacts with acoustical vibration modes in the glass. This causes a scattering mechanism to be formed that reflects some of the light back to the source.

SMC

status monitoring and control. The process by which the operation, configuration, and performance of individual elements in a network or system are monitored and controlled from a central location.

SNMP

Simple Network Management Protocol. A protocol that governs network management and the monitoring of network devices and their functions.

TEC

thermoelectric cooler. A device used to dissipate heat in electronic assemblies.

torque

A force that produces rotation or torsion. Usually expressed in lb-ft (pound-feet) or N-m (Newton-meters). The application of one pound of force on a lever at a point on the lever that is one foot from the pivot point would produce 1 lb-ft of torque.

TX

transmit or transmitter.



Americas Headquarters

Cisco Systems, Inc.
170 West Tasman Drive
San Jose, CA 95134-1706
USA

<http://www.cisco.com>

Tel: 408 526-4000

800 553-6387

Fax: 408 527-0883

This document includes various trademarks of Cisco Systems, Inc. Please see the Notices section of this document for a list of Cisco Systems, Inc., trademarks used in this document.

Product and service availability are subject to change without notice.

© 2018 Cisco Systems, Inc. All rights reserved.

First Published: June 2018