

Cisco HyperFlex Express HX225C M6 All Flash and Hybrid Server Nodes

A printed version of this document is only a copy and not necessarily the latest version. Refer to the following link for the latest released version:

<https://www.cisco.com/c/en/us/products/hyperconverged-infrastructure/hyperflex-hx-series/datasheet-listing.html>



CONTENTS

OVERVIEW	3
DETAILED VIEWS	5
Chassis Front View - HXAF225C-M6S-EXP (All Flash)	5
Chassis Front View - HX225C-M6S-EXP (Hybrid)	6
Detailed Chassis Rear Views	7
BASE SERVER NODE STANDARD CAPABILITIES and FEATURES	11
CONFIGURING the SERVER (User Selectable)	15
STEP 1 VERIFY SERVER SKU	16
STEP 2 SELECT CPU(s)	21
STEP 3 SELECT MEMORY	22
STEP 4 SELECT DRIVES	23
STEP 5 ORDER POWER SUPPLY	25
STEP 6 SELECT INPUT POWER CORD(s)	26
STEP 7 SELECT HYPERFLEX DATA PLATFORM SOFTWARE EXPRESS	29
STEP 8 CISCO INTERSIGHT™ SaaS EXPRESS	30
STEP 9 SELECT SERVICE and SUPPORT LEVEL	31
SPARE PARTS	34
SUPPLEMENTAL MATERIAL	39
Chassis	39
Risers	42
UPGRADING or REPLACING CPUs	45
UPGRADING or REPLACING MEMORY	46
TECHNICAL SPECIFICATIONS	47
Dimensions and Weight	47
Power Specifications	48
Environmental Specifications	51
Extended Operating Temperature Hardware Configuration Limits	52
Compliance Requirements	53

OVERVIEW

Cisco HyperFlex™ Systems unlock the full potential of hyperconvergence. The systems are based on an end-to-end software-defined infrastructure, combining software-defined computing in the form of Cisco Unified Computing System (Cisco UCS) servers; software-defined storage with the powerful Cisco HX Data Platform and software-defined networking with the Cisco UCS fabric that will integrate smoothly with Cisco Application Centric Infrastructure (Cisco ACI™). Together with a single point of connectivity and hardware management, these technologies deliver a preintegrated and adaptable cluster that is ready to provide a unified pool of resources to power applications as your business needs dictate.

The Cisco HyperFlex Express HX225C M6S All Flash and Hybrid Server Nodes extends the capabilities of Cisco's HyperFlex portfolio in a 1U form factor with the addition of the AMD CPUs, 16 DIMM slots per CPU for 3200-MHz DDR4 DIMMs with DIMM capacity points up to 64 GB. The maximum memory capacity for 2 CPUs is listed here:

- 2 TB: 32 x 64 GB DDR4 DIMMs

Drives

There are two server nodes to choose from:

- HXAF225C-M6S-EXP (All Flash) (see [Figure 1 on page 4](#)):
 - Up to 10 front SFF SAS/SATA SSDs
- HX225C-M6S-EXP (Hybrid) (see [Figure 1 on page 4](#)):
 - Up to 10 front SFF SAS/SATA HDDs and SSDs.

Rear PCIe Risers

The server accommodates the following:

- One to three half-height PCIe risers

Drive Controller

The server provides an internal slot for the following:

- Cisco 12G SAS pass-through HBA to control SAS/SATA drives.



NOTE: PCIe drives are controlled directly from the CPUs.

The Cisco HyperFlex Express HX225C M6 All Flash and Hybrid Server Nodes has two LOM ports (10Gbase-T LOM) and a single 1 GbE management port. A modular LAN on motherboard (mLOM) module provides up to two 100 GbE ports. A connector on the front of the chassis provides KVM functionality.

See [Figure 1 on page 4](#) for front and rear views of the HyperFlex Express HX225C M6 All Flash and Hybrid Server Nodes.

Figure 1 Cisco HyperFlex Express HX225C M6 All Flash and Hybrid Server Nodes

HXAF225C-M6S-EXP (All Flash)

10 front drives are SAS/SATA SDDs and NVMe (up to 2 NVMe front drives) drives

Front View (see [Figure 2 on page 5](#) for details)



HX225C-M6S-EXP (Hybrid)

10 front drives are SAS/SATA HDDs and SDDs

Front View (see [Figure 3 on page 6](#) for details)



Rear View (one half-height riser version) [Figure 4 on page 8](#)



Rear View (three half-height riser version) (see [Figure 5 on page 9](#) for details)



Rear View (two full-height riser version) (see [Figure 6 on page 10](#) for details)



DETAILED VIEWS

Chassis Front View - HXAF225C-M6S-EXP (All Flash)

Figure 2 shows the front view of the Cisco HyperFlex Express HXAF225C-M6S-EXP (All Flash) server node.

Figure 2 Chassis Front View

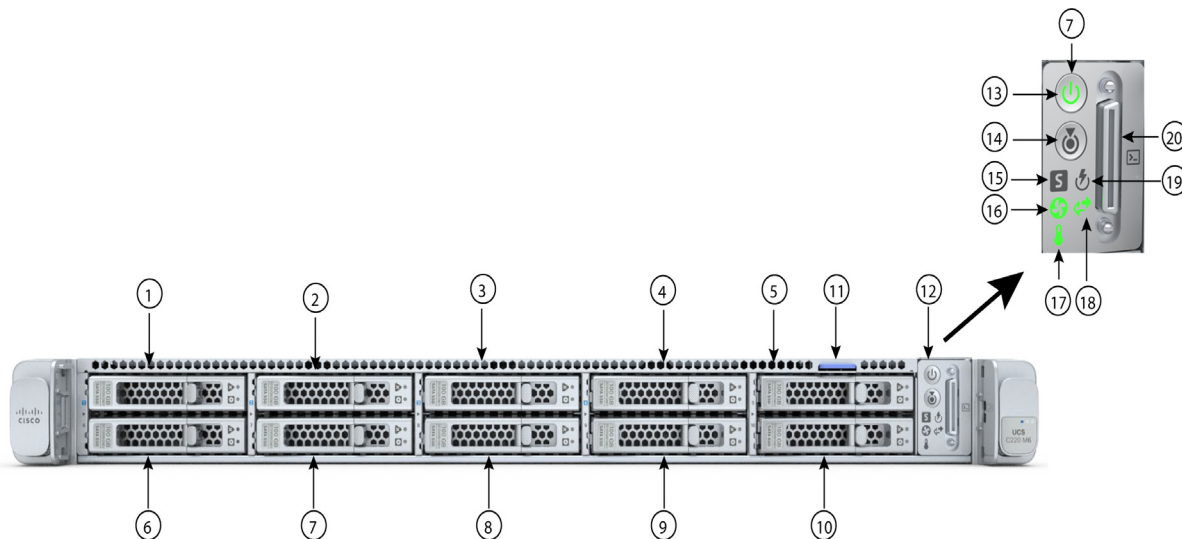

1 - 4	Drive bays 1 - 4 support SAS/SATA solid state drives (SSDs) or NVMe PCIe drives. ¹	15	System status LED
5 - 10	Drive bays 5 - 10 support SAS/SATA solid state drives (SSDs) only	16	Fan status LED
11	Asset tag location	17	Temperature status LED
12	Control panel	18	Network link activity LED
13	Power button/power status LED	19	Power supply status LED
14	Unit Identification button/LED	20	KVM connector (used with KVM cable that provides two USB 2.0, one VGA, and one serial connector)

Notes:

1. If NVMe drives are selected, you must also select 2 CPUs.

Chassis Front View - HX225C-M6S-EXP (Hybrid)

Figure 3 shows the front view of the Cisco HyperFlex Express HX225C-M6S-EXP (Hybrid) server node.

Figure 3 Chassis Front View

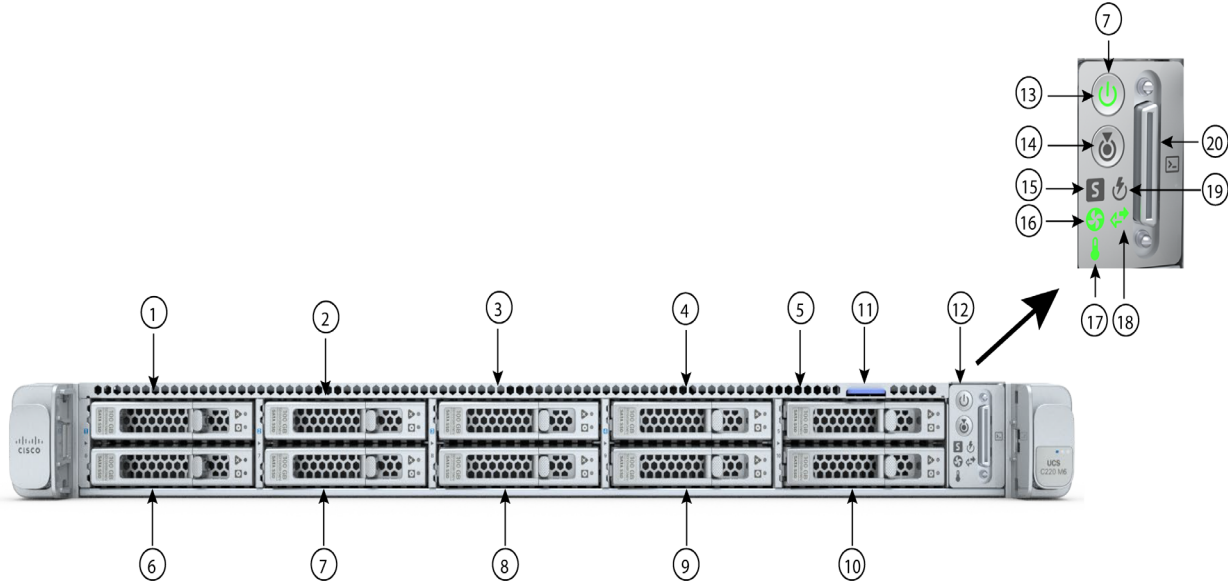

1 - 4	Drive bays 1 - 4 support SAS/SATA hard drives and solid state drives (SSDs)	15	System status LED
5 - 10	Drive bays 5 - 10 support SAS/SATA hard drives (HDDs) only	16	Fan status LED
11	Asset tag location	17	Temperature status LED
12	Control panel	18	Network link activity LED
13	Power button/power status LED	19	Power supply status LED
14	Unit Identification button/LED	20	KVM connector (used with KVM cable that provides two USB 2.0, one VGA, and one serial connector)

Detailed Chassis Rear Views

Figure 4 shows the details of the rear panel for the HyperFlex Express HX225C M6 All Flash and Hybrid Server Nodes with one rear half-height PCIe riser.

Figure 5 shows the details of the rear panel for the HyperFlex Express HX225C M6 All Flash and Hybrid Server Nodes with three rear half-height PCIe risers.

Figure 6 shows the details of the rear panel for the HyperFlex Express HX225C M6 All Flash and Hybrid Server Nodes with two rear full-height PCIe risers.

One Half-Height Riser

Figure 4 Chassis Rear View (one half-height, 3/4 length PCIe riser)

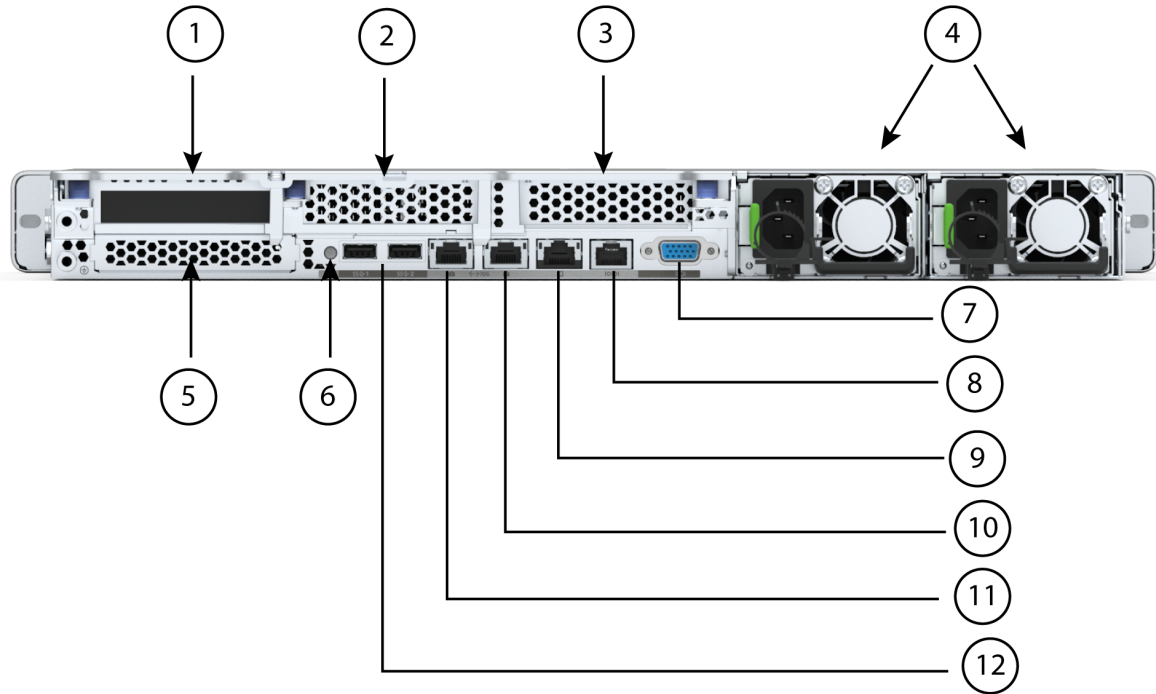

1	Riser 1 (CPU1 control) <ul style="list-style-type: none"> ■ Supports one PCIe slot ■ Slot 1 is half-height, 3/4 length, x16 	7	VGA display port (DB15 connector)
2	Riser 2 blanking panel	8	COM port (RJ45 connector)
3	Riser 3 blanking panel	9	1 GbE dedicated Ethernet management port
4	Power supplies (two, redundant as 1+1)	10 - 11	Dual 1/10 GbE Ethernet ports (LAN1, LAN2) LAN1 is left connector, LAN2 is right connector
5	Modular LAN on motherboard (mLOM)	12	USB 3.0 ports (two)
6	System ID pushbutton/LED	-	-

Three Half-Height Risers

Figure 5 Chassis Rear View (three half-height, 3/4 length PCIe risers)

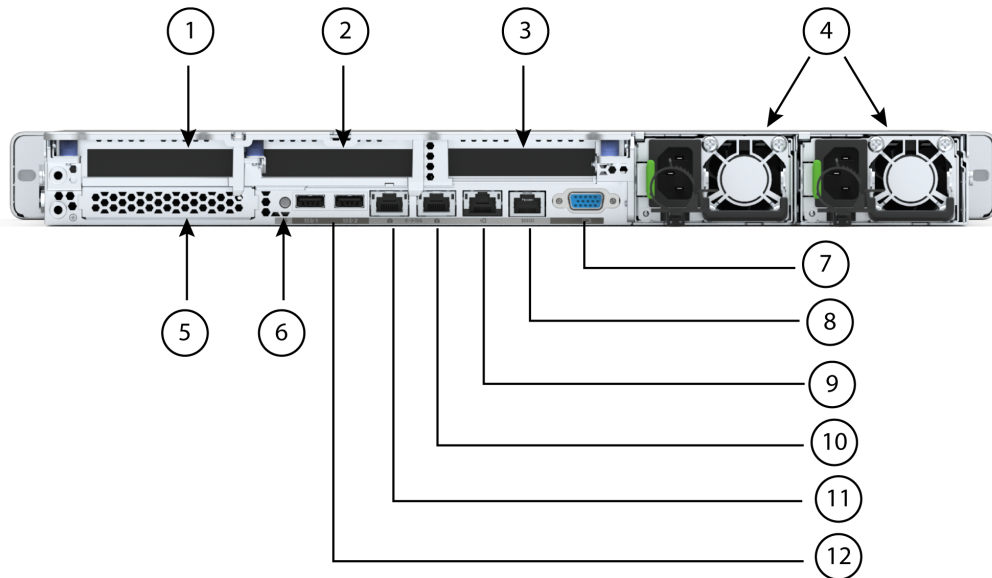

1	Riser 1 (CPU1 control) <ul style="list-style-type: none"> ■ Supports one PCIe slot (slot 1) ■ Slot 1 is half-height, 3/4 length, x16 	7	VGA display port (DB15 connector)
2	Riser 2 (CPU1 control) <ul style="list-style-type: none"> ■ Supports one PCIe slot (slot 2) ■ Slot 2 is half-height, 3/4 length, x16 	8	COM port (RJ45 connector)
3	Riser 3 (CPU2 control) <ul style="list-style-type: none"> ■ Supports one PCIe slot (slot 3) ■ Slot 3 is half-height, 3/4 length, x16 	9	1 GbE dedicated Ethernet management port
4	Power supplies (two, redundant as 1+1)	10 - 11	Dual 1/10 GbE Ethernet ports (LAN1, LAN2) LAN1 is left connector, LAN2 is right connector
5	Modular LAN on motherboard (mLOM)	12	USB 3.0 ports (two)
6	System ID pushbutton/LED	-	-

Two Full-Height Risers



NOTE: 1-CPU server support only full-height riser 1 while 2-CPU server support both full-height risers.

Figure 6 Chassis Rear View (two full-height, 3/4-length PCIe risers)

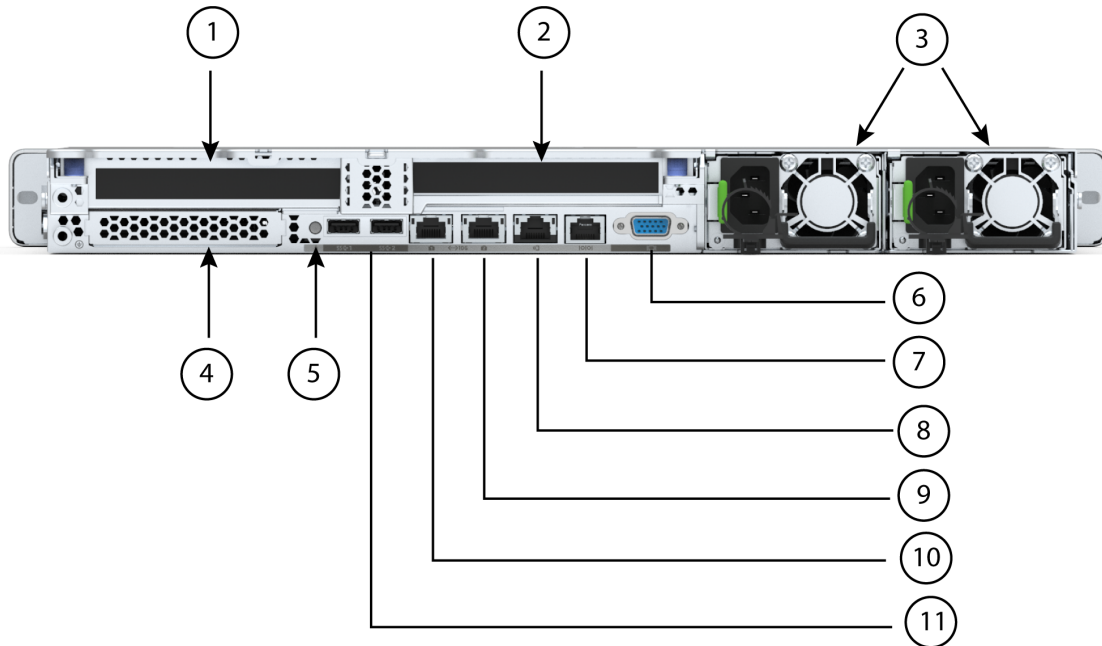

1	Riser 1 (CPU1 control) <ul style="list-style-type: none"> ■ Plugs into riser 1 motherboard connector ■ Full-height, 3/4 length, x16 	6	VGA display port (DB15 connector)
2	Riser 2 (CPU2 control) <ul style="list-style-type: none"> ■ Plugs into riser 3 motherboard connector ■ Full-height, 3/4 length, x16 	7	COM port (RJ45 connector)
3	Power supplies (two, redundant as 1+1)	8	1 GbE dedicated Ethernet management port
4	Modular LAN on motherboard (mLOM)	9 -10	Dual 1/10 GbE Ethernet ports (LAN1, LAN2) LAN1 is left connector, LAN2 is right connector
5	System ID pushbutton/LED	11	USB 3.0 ports (two)

BASE SERVER NODE STANDARD CAPABILITIES and FEATURES

Table 1 lists the capabilities and features of the base server node. Details about how to configure the server for a particular feature or capability (for example, number of processors, disk drives, or amount of memory) are provided in *CONFIGURING the SERVER (User Selectable)*, page 15.

Table 1 Capabilities and Feature of HyperFlex Express HX225C M6 All Flash and Hybrid Server Node

Capability/Feature	Description
Chassis	One rack unit (1RU) chassis
CPU	One or two AMD Milan CPUs ¹
Memory	32 slots for registered DIMMs (RDIMMs) or load-reduced DIMMs (LRDIMMs)
Multi-bit Error Protection	This server supports multi-bit error protection.
Video	<p>The Cisco Integrated Management Controller (CIMC) provides video using the Matrox G200e video/graphics controller:</p> <ul style="list-style-type: none"> ■ Integrated 2D graphics core with hardware acceleration ■ Embedded DDR memory interface supports up to 512 MB of addressable memory (8 MB is allocated by default to video memory) ■ Supports display resolutions up to 1920 x 1200 16bpp @ 60Hz ■ High-speed integrated 24-bit RAMDAC ■ Single lane PCI-Express host interface running at Gen 1 speed
Power subsystem	<p>Up to two of the following hot-swappable power supplies:</p> <ul style="list-style-type: none"> ■ 1050 W (AC) ■ 1050 W (DC) ■ 1600 W (AC) <p>One power supply is mandatory; one more can be added for 1 + 1 redundancy.</p>
Front Panel	A front panel controller provides status indications and control buttons
ACPI	<p>This server supports the advanced configuration and power interface (ACPI)</p> <p>Rome - ACPI version 6.2 Milan - ACPI version 6.3</p>
Fans	Eight hot-swappable fans for front-to-rear cooling

Table 1 Capabilities and Feature (*continued*)of HyperFlex Express HX225C M6 All Flash and Hybrid Server

Capability/Feature	Description
Expansion slots	<p>Three half-height riser slots</p> <ul style="list-style-type: none"> ■ Riser 1 (controlled by CPU 1): <ul style="list-style-type: none"> • One x16 PCIe Gen4 Slot, (Cisco VIC), half-height, 3/4 length ■ Riser 2 (controlled by CPU 1): <ul style="list-style-type: none"> • One x16 PCIe Gen4 Slot, half-height, 3/4 length ■ Riser 3 (controlled by CPU 2): <ul style="list-style-type: none"> • One x16 PCIe Gen4 Slot, (Cisco VIC), half-height, 3/4 length <p>Two full-height riser slots</p> <ul style="list-style-type: none"> ■ Riser 1 (controlled by CPU 1): <ul style="list-style-type: none"> • One x16 PCIe Gen4 Slot, (Cisco VIC), full-height, 3/4 length ■ Riser 2² (controlled by CPU 2): <ul style="list-style-type: none"> • One x16 PCIe Gen4 Slot, (Cisco VIC), full-height, 3/4 length
Interfaces	<ul style="list-style-type: none"> ■ Rear panel <ul style="list-style-type: none"> • One 1Gbase-T RJ-45 management port • One RS-232 serial port (RJ45 connector) • One DB15 VGA connector • Two USB 3.0 port connectors • One flexible modular LAN on motherboard (mLOM) slot that can accommodate various interface cards ■ Front panel <ul style="list-style-type: none"> • One KVM console connector (supplies two USB 2.0 connectors, one VGA DB15 video connector, and one serial port (RS232) RJ45 connector)

Table 1 Capabilities and Feature (*continued*)of HyperFlex Express HX225C M6 All Flash and Hybrid Server

Capability/Feature	Description
Internal storage devices	<p><u>Drive storage:</u></p> <p>This is orderable in two different server nodes:</p> <p>HXAF225C-M6S-EXP (All Flash):</p> <ul style="list-style-type: none"> ■ Up to 10 SFF SAS/SATA solid state drives (SSDs). 10 Drives are used as below: <ul style="list-style-type: none"> • Six to eight SAS/SATA SSD (for capacity) • One SAS/SATA SSD (for caching) • One SAS/SATA SSD (system drive for HXDP operations) <p>HX225C-M6S-EXP (Hybrid):</p> <ul style="list-style-type: none"> ■ Up to 10 SFF SAS/SATA hard drives (HDDs) and SAS/SATA solid state drives (SSDs). 10 Drives are used as below: <ul style="list-style-type: none"> • Six to eight SAS HDD (for capacity) • One SAS/SATA SSD (for caching) • One SAS/SATA SSD (system drive for HXDP operations) <p><u>Other storage:</u></p> <ul style="list-style-type: none"> ■ A mini-storage module connector on the motherboard supports a boot-optimized RAID controller carrier that holds up two SATA M.2 SSDs. Mixing different capacity SATA M.2 SSDs is not supported.
Integrated management processor	<p>Baseboard Management Controller (BMC) running Cisco Integrated Management Controller (CIMC) firmware.</p> <p>Depending on your CIMC settings, the CIMC can be accessed through the 1GE dedicated management port, the 1GE/10GE LOM ports, or a Cisco virtual interface card (VIC).</p> <p>CIMC manages certain components within the server, such as the Cisco 12G SAS HBA.</p>
Storage controllers	<ul style="list-style-type: none"> ■ Cisco 12G SAS HBA <ul style="list-style-type: none"> • No RAID support • JBOD/Pass-through Mode support • Supports up to 10 SAS/SATA internal drives
Modular LAN on Motherboard (mLOM)	<p>The dedicated mLOM slot on the motherboard can flexibly accommodate the following cards:</p> <ul style="list-style-type: none"> ■ Cisco Virtual Interface Cards
Intersight	Intersight provides server management capabilities
CIMC	Cisco Integrated Management Controller 4.2(1) or later

Notes:

1. If NVMe drives are selected, you must also select 2 CPUs.

2. There are three PCIe riser connectors on the motherboard: they are labeled Riser 1, Riser 2, and Riser 3. If the server is configured with three half-height risers, Riser 1 plugs into Riser 1 connector, Riser 2 plugs into Riser 2 connector, and Riser 3 plugs into Riser 3 connector. If the server is configured with two full-height connectors, Riser 1 plugs into Riser 1 connector and Riser 2 plugs into Riser 3 connector. See [Risers, page 42](#) for more details.

CONFIGURING the SERVER (User Selectable)

Follow these steps to configure the Cisco HyperFlex Express HX225C M6 All Flash and Hybrid Server Nodes:

- *STEP 1 VERIFY SERVER SKU, page 16*
- *STEP 2 SELECT CPU(s), page 21*
- *STEP 3 SELECT MEMORY, page 22*
- *STEP 5 ORDER POWER SUPPLY, page 25*
- *STEP 6 SELECT INPUT POWER CORD(s), page 26*
- *STEP 7 SELECT HYPERFLEX DATA PLATFORM SOFTWARE EXPRESS, page 29*
- *STEP 8 CISCO INTERSIGHT™ SaaS EXPRESS, page 30*
- *STEP 9 SELECT SERVICE and SUPPORT LEVEL, page 31*

STEP 1 VERIFY SERVER SKU

NOTE: Cisco HyperFlex Express HX225C M6 All Flash and Hybrid Server Nodes comes with few components pre-configured/auto included and for few components where user need to make a selection.

- **Auto Included:** [Table 3.a](#) and [Table 3.b](#) shows the auto included component with the respective nodes.
- **User Selectable:** [STEP 2](#) to [STEP 9](#), please select the components that you want to include with your selected node.

Table 2 PID of Major Line Bundle (MLB)

Product ID (PID)	Description
HX-EXPRESS-MLB	This major line bundle (MLB) consists of the HyperFlex Express All Flash and Hybrid Server Nodes, with Intersight and HXDP software spare PIDs.

Select one of the product ID (PID) from [Table 3](#).

Table 3 PIDs of the HyperFlex Express HX225C M6 All Flash and Hybrid Server Nodes

Product ID (PID)	Description
HXAF225C-M6S-EXP ^{1,4} (All Flash)	Cisco HyperFlex Express HX225C M6 All Flash server node <ul style="list-style-type: none"> ■ Up to 10 SFF front SAS/SATA SSD drives.
HX225C-M6S-EXP ^{2,3} (Hybrid)	Cisco HyperFlex Express HX225C M6 Hybrid server node <ul style="list-style-type: none"> ■ Up to 10 SFF front SAS/SATA HDD/SSD drives.

Notes:

1. Refer to the [Table 3.a](#) for auto included PIDs/Components with the selection of HXAF225C-M6S-EXP (All Flash) server and follow [STEP 2](#) to [STEP 9](#) for configure the product.
2. Refer to the [Table 3.b](#) for auto included PIDs/Components with the selection of HX225C-M6S-EXP (Hybrid) server and follow [STEP 2](#) to [STEP 9](#) to configure the product.
3. This product may not be purchased outside of the approved bundles (must be ordered under the MLB)



NOTE:

- The Cisco HyperFlex Express HX225c M6 All Flash and Hybrid server nodes do not include CPUs, front capacity drives and power supplies.
- Use the [STEP 2](#) to [STEP 9](#) on the following pages to configure the server with the components that you want to include.

Table 3.a lists auto included components with the **HXAF225C-M6S-EXP (All Flash)** Server Node

Table 3.a Auto Included Components with HXAF225C-M6S-EXP (All Flash)

Product ID (PID)	PID Description	QTY Included
Memory		
HX-MR-X64G2RW	64GB RDIMM DRx4 3200 (16Gb)	4
Drive Controller		
HX-SAS-220M6	Cisco 12G SAS HBA for (16 drives) w/1U Brkt	1
Front Cache Drive		
HX-SD800GK3X-EP	800GB 2.5in Enterprise Performance 12G SAS SSD(3X endurance)	1
Front System Drive		
HX-SYSTEMDRIVE	Housekeeping	1
HX-SD240GM1X-EV	240GB 2.5 inch Enterprise Value 6G SATA SSD	1
Boot Drives		
HX-M2-BOOT	M2 BOOT	1
HX-M2-240GB	240GB SATA M.2	2
HX-M2-HWRAID	Cisco Boot optimized M.2 Raid controller	1
PCIe MLOM		
HX-M-V25-04	Cisco UCS VIC 1467 quad port 25G SFP28 mLOM	1
Security Option		
HX-TPM-002C	TPM 2.0, TCG, FIPS140-2, CC EAL4+ Certified, for M6 servers	1
Rail Kit		
HX-RAIL-M6	Ball Bearing Rail Kit for C220 & C240 M6 rack servers	1
Heat Sink (Depends on the quantity of the CPU selection)		
UCSC-HSHP-225M6	Heatsink 1U SFF M6 PCIe SKU	=QTY of CPU selected
DIMM Blanks		
UCS-DIMM-BLK	UCS DIMM Blanks	28
Blanking Panel		
UCSC-BBLKD-S2	UCS C-Series M5 SFF drive blanking panel	8 - QTY of Capacity Drive selected

Table 3.a Auto Included Components with HXAF225C-M6S-EXP (All Flash)

Drive Controller Cable		
CBL-SAS-C220M6	Cisco 12G SAS HBA for (16 drives) w/1U Brkt	1
Power Supply Blanking Panel		
UCSC-PSU-M5BLK	Power Supply Blanking Panel for M5 servers	2 - QTY of Power Supply selected
Riser Card Kit		
UCSC-R2R3-C220M6	C220 / C225 M6 UCSC -HH Riser2 and Riser 3 KIT	1
Security Bezel		
HXAF220C-BZL-M5S	HXAF220C M5 Security Bezel	1

Table 3.b lists auto included components with the HX225C-M6S-EXP (Hybrid) Server Node.

Table 3.b Auto Included Components with HX225C-M6S-EXP (Hybrid)

Product ID (PID)	PID Description	QTY Included
Memory		
HX-MR-X64G2RW	64GB RDIMM DRx4 3200 (16Gb)	4
Drive Controller		
HX-SAS-220M6	Cisco 12G SAS HBA for (16 drives) w/1U Brkt	1
Front Cache Drive		
HX-SD480G63X-EP	480GB 2.5in Enterprise Performance 6GSATA SSD(3X endurance)	1
Front System Drive		
HX-SYSTEMDRIVE	Housekeeping	1
HX-SD240GM1X-EV	240GB 2.5 inch Enterprise Value 6G SATA SSD	1
Boot Drives		
HX-M2-BOOT	M2 BOOT	1
HX-M2-240GB	240GB SATA M.2	2
HX-M2-HWRAID	Cisco Boot optimized M.2 Raid controller	1
PCIe MLOM		
HX-M-V25-04	Cisco UCS VIC 1467 quad port 25G SFP28 mLOM	1
Security Option		
HX-TPM-002C	TPM 2.0, TCG, FIPS140-2, CC EAL4+ Certified, for M6 servers	1
Rail Kit		
HX-RAIL-M6	Ball Bearing Rail Kit for C220 & C240 M6 rack servers	1
Heat Sink		
UCSC-HSHP-225M6	Heatsink 1U SFF M6 PCIe SKU	= QTY of CPU selected
DIMM Blanks		
UCS-DIMM-BLK	UCS DIMM Blanks	28
Blanking Panel		
UCSC-BBLKD-S2	UCS C-Series M5 SFF drive blanking panel	8 - QTY of Capacity Drive selected

Table 3.b Auto Included Components with HX225C-M6S-EXP (Hybrid)

Drive Controller Cable		
CBL-SAS-C220M6	Cisco 12G SAS HBA for (16 drives) w/1U Brkt	1
Power Supply Blanking Panel		
UCSC-PSU-M5BLK	Power Supply Blanking Panel for M5 servers	2 - QTY of Power Supply selected
Riser Card Kit		
UCSC-R2R3-C220M6	C220 / C225 M6 UCSC -HH Riser2 and Riser 3 KIT	1
Security Bezel		
HX220C-BZL-M5S	HX220C M5 Security Bezel	1



NOTE:

- **VMware ESXi Hypervisor** - We no longer ship VMWare ESXi from the factory. Refer to this link for the further details.
https://www.cisco.com/c/en/us/td/docs/hyperconverged_systems/HyperFlex_HX_DataPlatformSoftware/BroadcomAgreementNotice/b-broadcom-terminated-vmware-embedded-agreement.html
- **Microsoft operating system** - Optional guest OS licenses that may be purchased to run on top of the hypervisor.

STEP 2 SELECT CPU(s)

The standard CPU features are:

- Milan® family CPUs
- CPU-to-CPU communication using Infinity Fabric Interconnect
- Cache size of up to 256 MB
- Up to 64 cores

Select CPUs

The available CPUs are listed in [Table 4](#).

Table 4 Available CPUs

Product ID (PID)	Clock Freq (GHz)	Power (W)	L3 Cache Size (MB)	Cores	Highest DDR4 DIMM Clock Support (MHz) ¹
Milan Processors					
HXE-CPU-A7763	2.45	280	256	64	3200
HXE-CPU-A7543	2.80	225	256	32	3200
HXE-CPU-A7413	2.65	180	128	24	3200

Notes:

1. If higher or lower speed DIMMs are selected than what is shown in [Table 5 on page 22](#) for a given CPU speed, the DIMMs will be clocked at the lowest common denominator of CPU clock and DIMM clock.

Approved Configurations

(1) One-CPU Configuration

- Choose one CPU from any one of the rows of [Table 4 Available CPUs, page 21](#).

(2) Two-CPU Configuration

- Choose two identical CPUs from any one of the rows of [Table 4 Available CPUs, page 21](#).

STEP 3 SELECT MEMORY

The available memory main characteristics for the HyperFlex Express HX220C M6 All NVMe/All Flash/Hybrid Server Nodes are as follows:

- Clock speed: 3200 MHz
- Operational voltage: 1.2 V
- Registered ECC DDR4 DIMMS (RDIMMs)

Select DIMMs

The supported memory DIMMs are listed in [Table 5](#).

Table 5 Available DDR4 DIMMs

Product ID (PID)	PID Description	Voltage	Ranks /DIMM
HXE-MR-X64G2RW	Cisco HX Express 64GB RDIMM DRx4 3200 (16Gb)	1.2 V	2

STEP 4 SELECT DRIVES

The standard disk drive features are:

- 2.5-inch small form factor
- Hot-pluggable
- Drives come mounted in sleds

Select Drives - [HXAF225C-M6S-EXP \(All Flash\)](#)

The available drives are listed in [Table 6](#).

Table 6 Available Hot-Pluggable Sled-Mounted Drives

Product ID (PID)	PID Description	Drive Type	Capacity
Front Capacity Drive			
HXE-SD38T6S1X-EV	Cisco HX Express 3.8TB 2.5inch Enterprise Value 6G SATA SSD	SATA	3.8 TB
HXE-SD76T6S1X-EV	Cisco HX Express 7.6TB 2.5inch Enterprise Value 6G SATA SSD	SATA	7.6 TB
<p>NOTE: Cisco uses solid state drives (SSDs) from a number of vendors. All solid state drives (SSDs) are subject to physical write limits and have varying maximum usage limitation specifications set by the manufacturer. Cisco will not replace any solid state drives (SSDs) that have exceeded any maximum usage specifications set by Cisco or the manufacturer, as determined solely by Cisco.</p>			

Approved Configurations

Capacity Drives:

- Six to eight front capacity drives

Select Drives - HX225C-M6S-EXP (Hybrid)

The available drives are listed in [Table 7](#).

Table 7 Available Hot-Pluggable Sled-Mounted Drives

Product ID (PID)	PID Description	Drive Type	Capacity
Front Capacity Drive			
HXE-HD24TB10K4KN	Cisco HX Express 2.4 TB 12G SAS 10K RPM SFF HDD (4K)	SAS	2.4 TB

Approved Configurations

Capacity Drives:

- Six to eight front capacity drives

STEP 5 ORDER POWER SUPPLY

Power supplies share a common electrical and physical design that allows for hot-plug and tool-less installation into HyperFlex Express M6 servers. Each power supply is certified for high-efficiency operation and offers multiple power output options. This allows users to “right-size” based on server configuration, which improves power efficiency, lowers overall energy costs and avoids stranded capacity in the data center. Use the power calculator at the following link to determine the needed power based on the options chosen (CPUs, drives, memory, and so on):

<http://ucspowercalc.cisco.com>



WARNING:

- Starting 1st January 2024, only Titanium rated PSUs are allowed to be shipped to European Union (EU), European Economic Area (EEA), United Kingdom (UK), Switzerland and other countries that adopted Lot 9 Regulation.
- DC PSUs are not impacted by Lot 9 Regulation and are EU/UK Lot 9 compliant

Table 8 Power Supply

Product ID (PID)	PID Description
PSU (Input High Line 210VAC)	
HXE-PSU1-1050W	Cisco HX Express 1050W AC PSU Platinum (Not EU/UK Lot 9 Compliant)
HXE-PSUV2-1050DC	Cisco HX Express 1050W -48V DC Power Supply for Rack Server
HXE-PSU1-1600W	Cisco HX Express 1600W AC PSU Platinum (Not EU/UK Lot 9 Compliant)
PSU (Input Low Line 110VAC)	
HXE-PSU1-1050W	Cisco HX Express 1050W AC PSU Platinum (Not EU/UK Lot 9 Compliant)
HXE-PSUV2-1050DC	Cisco HX Express 1050W -48V DC Power Supply for Rack Server



NOTE: In a server with two power supplies, both power supplies must be identical.

STEP 6 SELECT INPUT POWER CORD(s)

Using [Table 9](#), select the appropriate AC power cords. You can select a minimum of no power cords and a maximum of two. If you select the option R2XX-DMYPWRCORD, no power cord is shipped with the server.



NOTE: [Table 9](#) lists the power cords for servers that use power supplies.

Table 9 Available Power Cords

Product ID (PID)	PID Description	Images
NO-POWER-CORD	ECO friendly green option, no power cable will be shipped	Not applicable
R2XX-DMYPWRCORD	No power cord (dummy PID to allow for a no power cord option)	Not applicable
CAB-48DC-40A-8AWG	C-Series -48VDC PSU Power Cord, 3.5M, 3 Wire, 8AWG, 40A	<p>Figure 1-3 CAB-48DC-40A-8AWG, DC Power Cord (3.5 m)</p>
CAB-N5K6A-NA	Power Cord, 200/240V 6A, North America	
CAB-AC-L620-C13	AC Power Cord, NEMA L6-20 - C13, 2M/6.5ft	
CAB-C13-CBN	CABASY,WIRE,JUMPER CORD, 27" L, C13/C14, 10A/250V	
CAB-C13-C14-2M	CABASY,WIRE,JUMPER CORD, PWR, 2 Meter, C13/C14,10A/250V	

Table 9 Available Power Cords

Product ID (PID)	PID Description	Images
CAB-C13-C14-AC	CORD,PWR,JMP,IEC60320/C14,IEC60320/C13, 3.0M	
CAB-250V-10A-AR	Power Cord, 250V, 10A, Argentina	
CAB-9K10A-AU	Power Cord, 250VAC 10A 3112 Plug, Australia	
CAB-250V-10A-CN	AC Power Cord - 250V, 10A - PRC	
CAB-9K10A-EU	Power Cord, 250VAC 10A CEE 7/7 Plug, EU	
CAB-250V-10A-ID	Power Cord, 250V, 10A, India	
CAB-C13-C14-3M-IN	Power Cord Jumper, C13-C14 Connectors, 3 Meter Length, India	Image not available
CAB-C13-C14-IN	Power Cord Jumper,C13-C14 Connectors,1.4 Meter Length, India	Image not available
CAB-250V-10A-IS	Power Cord, SFS, 250V, 10A, Israel	

Table 9 Available Power Cords

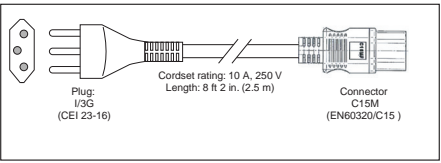
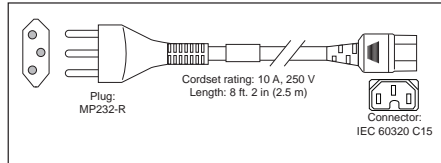
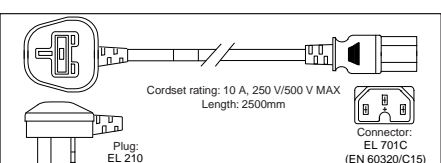
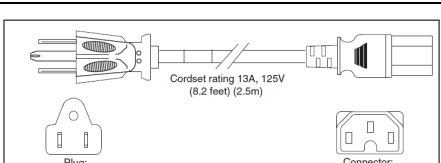
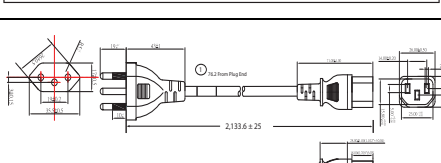
Product ID (PID)	PID Description	Images
CAB-9K10A-IT	Power Cord, 250VAC 10A CEI 23-16/VII Plug, Italy	 <p>Plug: 13G3 (CEI 23-16)</p> <p>Cordset rating: 10 A, 250 V Length: 8 ft 2 in. (2.5 m)</p> <p>Connector: C15M (EN60320/C15)</p>
CAB-9K10A-SW	Power Cord, 250VAC 10A MP232 Plug, Switzerland	 <p>Plug: MP232-R</p> <p>Cordset rating: 10 A, 250 V Length: 8 ft. 2 in (2.5 m)</p> <p>Connector: IEC 60320 C15</p>
CAB-9K10A-UK	Power Cord, 250VAC 10A BS1363 Plug (13 A fuse), UK	 <p>Plug: EL 210 (BS 1363A) 13 AMP fuse</p> <p>Cordset rating: 10 A, 250 V/500 V MAX Length: 2500mm</p> <p>Connector: EL 701 C (EN 60320/C15)</p>
CAB-9K12A-NA ¹	Power Cord, 125VAC 13A NEMA 5-15 Plug, North America	 <p>Plug: NEMA 5-15P</p> <p>Cordset rating: 13A, 125V (8.2 feet) (2.5m)</p> <p>Connector: IEC60320/C15</p>
CAB-250V-10A-BR	Power Cord - 250V, 10A - Brazil	
CAB-C13-C14-2M-JP	Power Cord C13-C14, 2M/6.5ft Japan PSE mark	Image not available
CAB-9K10A-KOR ¹	Power Cord, 125VAC 13A KSC8305 Plug, Korea	Image not available
CAB-JPN-3PIN	Japan, 90-125VAC 12A NEMA 5-15 Plug, 2.4m	Image not available
CAB-48DC-40A-AS	C-Series -48VDC PSU PWR Cord, 3.5M, 3Wire, 8AWG, 40A (AS/NZ	Image not available
CAB-48DC-40A-INT	C-Series -48VDC PSU PWR Cord, 3.5M, 3 Wire, 8AWG, 40A (INT)	Image not available

Notes:

1. This power cord is rated to 125V and only supported for PSU rated at 1050W or less

STEP 7 SELECT HYPERFLEX DATA PLATFORM SOFTWARE EXPRESS

Cisco HyperFlex Data Platform Software Express Edition & Subscription. Period options are available as follows.

Product ID (PID)	
HXDP-SW-EXP	Cisco HyperFlex Data Platform Software Express

Select the Software as desired from [Table 10](#).

Table 10 HyperFlex Data Platform Software Express

Product ID (PID)	PID Description
HXDP-DC-AD	HyperFlex Data Platform Data center Advantage (3 to 5) Yr
HXDP-DC-PR	HyperFlex Data Platform Data center Premier (3 to 5) Yr
Cisco HyperFlex Data Platform Software - SLR	
HXDP-DC-AD-SLR	HyperFlex Data Platform Data center Advantage SLR (3 to 5) Yr
HXDP-DC-PR-SLR	HyperFlex Data Platform Data center Premier SLR (3 to 5) Yr
Cisco HyperFlex Data Platform Software Support	
SVS-DCM-SUPT-BAS	Basic Support for DCM
SVS-SSTCS-DCMGMT	Solution Support for DC Mgmt
SVS-L1DCS-HXDP	CXL1 for HXDP
SVS-L2DCS-HXDP	CXL2 for HXDP

Select the Software Package as from [Table 11](#)

Table 11 Software Package

Product ID (PID)	
HXDP-SW-PKG-SE-K9=	Cisco HyperFlex Software Package for Encryption

STEP 8 CISCO INTERSIGHT™ SaaS EXPRESS

Cisco Intersight™ is a Software-as-a-Service (SaaS) hybrid cloud operations platform which delivers intelligent automation, observability, and optimization to customers for traditional and cloud-native applications and infrastructure.

Product ID (PID)	
DC-MGT-SAAS-EXP	Cisco Intersight SaaS Express

Select Cisco Intersight option as desired from [Table 12](#)

Table 12 Cisco Intersight SaaS Express

Product ID (PID)	PID Description
Cisco Intersight - SaaS	
DC-MGT-SAAS-AD-C	Cisco Intersight SaaS - Advantage (new) (3 to 5) Yr
DC-MGT-SAAS-PR-C	Cisco Intersight SaaS - Premier (3 to 5) Yr
Cisco Intersight - Connected Virtual Appliance	
DC-MGT-VAPP-AD	Cisco Intersight Connected Virtual Appliance - Advantage (3 to 5) Yr
DC-MGT-VAPP-PR	Cisco Intersight Connected Virtual Appliance - Premier (3 to 5) Yr
Cisco Intersight - Private Virtual Appliance	
DC-MGT-PVAPP-AD	Cisco Intersight Private Virtual Appliance - Advantage (3 to 5) Yr
DC-MGT-PVAPP-PR	Cisco Intersight Private Virtual Appliance - Premier (3 to 5) Yr
Cisco Intersight Support	
SVS-DCM-SUPT-BAS	Basic Support for DCM
SVS-SSTCS-DCMGMT	Solution Support for DC Mgmt
SVS-L1DCS-INTER	CXL1 for INTERSIGHT
SVS-L2DCS-INTER	CXL2 for INTERSIGHT

STEP 9 SELECT SERVICE and SUPPORT LEVEL

A variety of service options are available, as described in this section.

HyperFlex Warranty, No Contract

If you have noncritical implementations and choose to have no service contract, the following coverage is supplied:

- Three-year parts coverage.
- Next business day (NBD) onsite parts replacement eight hours a day, five days a week.
- 90-day software warranty on media.
- Ongoing downloads of BIOS, drivers, and firmware updates.
- UCSM updates for systems with Unified Computing System Manager. These updates include minor enhancements and bug fixes that are designed to maintain the compliance of UCSM with published specifications, release notes, and industry standards.

Smart Net Total Care (SNTC)

For support of the entire HyperFlex System, Cisco offers the Cisco Smart Net Total Care Service. This service provides expert software and hardware support to help sustain performance and high availability of the unified computing environment. Access to Cisco Technical Assistance Center (TAC) is provided around the clock, from anywhere in the world.

For systems that include Unified Computing System Manager, the support service includes downloads of UCSM upgrades. The Cisco Smart Net Total Care Service includes flexible hardware replacement options, including replacement in as little as two hours. There is also access to Cisco's extensive online technical resources to help maintain optimal efficiency and uptime of the unified computing environment. For more information please refer to the following url: <http://www.cisco.com/c/en/us/services/technical/smart-net-total-care.html?stickynav=1>

You can choose a desired service listed in [Table 13](#).

Table 13 SNTC Service (PID HX225C-M6S-EXP)

Service SKU	Service Level GSP	On Site?	Description
CON-OSP-HX225CMP	C4P	Yes	SNTC 24X7X40S
CON-SNT-HX225CMP	SNT	No	SNTC 8X5XNBD
Note: For PID HXAF225C-M6S-EXP, select Service SKU with HXAF25SC suffix (Exmple: CON-OSP-HXAF25SC)			

Solution Support (SSPT)

Solution Support includes both Cisco product support and solution-level support, resolving complex issues in multivendor environments, on average, 43% more quickly than product support alone. Solution Support is a critical element in data center administration, to help rapidly resolve any issue encountered, while maintaining performance, reliability, and return on investment.

This service centralizes support across your multivendor Cisco environment for both our products and solution partner products you’ve deployed in your ecosystem. Whether there is an issue with a Cisco or solution partner product, just call us. Our experts are the primary point of contact and own the case from first call to resolution. For more information please refer to the following url:

<http://www.cisco.com/c/en/us/services/technical/solution-support.html?stickynav=1>

Table 14 Solution Support Service (HX225C-M6S-EXP)

Service SKU	Service Level GSP	On Site?	Description
CON-SSC4P-HX225CMP	SSC4P	Yes	SOLN SUPP 24X7X4OS
CON-SSSNT-HX225CMP	SSSNT	No	SOLN SUPP 8X5XNBD
Note: For PID HXAF225C-M6S-EXP, select Service SKU with HXAF25SC suffix (Example: CON-SSC4P-HXAF25SC)			

Success Tracks (ST)

Success Tracks builds on the Smart Net Total Care and Solution Support offers as described above and provides access to the CX Cloud, a centralized, web-based portal which is a personalized connection to Cisco for accessing support, knowledge, insights, and recommendations from Cisco experts to maximize the value of Cisco assets. CX Cloud connects you with Cisco's global user base to share your expertise, exchange ideas, and discuss best practices.

With Level 1 Support Cisco provides resources that support running and maintaining Products. You will have access to “Ask the Experts” knowledge sessions. These sessions are led by solution specialists who teach best practices for operating Products. Access to CX Centers will be available 24x7 to help resolve Product issues with Solution Support; this access streamlines case management for solutions comprised of Cisco and Solution Support Alliance Partner products. In addition, you will have access to case information, up-to-date install base views, and e-learning courses.

You can choose a desired service listed in [Table 15](#).

Table 15 Success Tracks Level 1 Service (PID HX225C-M6S-EXP)

Service SKU	Service Level GSP	On Site?	Description
CON-L14OS-HX225CMP	L14OS	Yes	CX LEVEL 1 24X7X4OS
CON-SSSNT-HX225CMP	L1NBD	No	CX LEVEL 1 8X5XNBD
Note: For PID HXAF225C-M6S-EXP, select Service SKU with HXAF25SC suffix (Example: CON-L14OS-HXAF25SC)			

With Level 2 Support Cisco will accelerate Your journey to realize Your desired outcomes through 1-on-1 personalized coaching engagements. Solution Support streamlines case management for solutions comprised of Cisco and Solution Support Alliance Partner products. Proactive features help prevent unplanned outages and save You time and costs, while You can also boost productivity and retain talent through hands-on learning labs and certification preparation materials.

You can choose a desired service listed in [Table 16](#).

Table 16 Success Tracks Level 2 Service (PID HX225C-M6S-EXP)

Service SKU	Service Level GSP	On Site?	Description
CON-L240S-HX225CMP	L240S	Yes	CX LEVEL 2 24X7X40S
CON-L2NBD-HX225CMP	L2NBD	No	CX LEVEL 2 8X5XNBD
Note: For PID HXAF225C-M6S-EXP, select Service SKU with HXAF25SC suffix (Example: CON-L140S-HXAF25SC)			

SPARE PARTS

This section lists the upgrade and service-related parts for the HyperFlex Express HX225C M6 All Flash and Hybrid Server Nodes. Some of these parts are configured with every server.



NOTE: Some spare parts you order may also require accessories for full functionality. For example, drives or RAID controllers may need accompanying cables. CPUs may need heatsinks, thermal paste, and installation tools. The spares and their accessory parts are listed in [Table 17](#).

Table 17 Spare Parts

Product ID (PID)	PID Description
KVM Cable	
N20-BKVM=	KVM local IO cable for UCS servers console port
Risers	
UCSC-R2R3-C220M6=	Kit containing two half-height risers (risers 2 and 3)
HX-GPURKIT-C220=	Kit containing a GPU mounting bracket and the following risers (risers 1 and 2)
UCSC-FBRS-C220M6=	Riser 2 and Riser 3 blank panels
CPUs	
<p>Note: If you are ordering a second CPU, see the CPU Accessories section in this table for additional parts you may need to order for the second CPU.</p>	
Milan Processors	
HXE-CPU-A7763	Cisco HX EXP AMD 2.45GHz 7763 280W64C/256MB CacheDDR43200MHz
HXE-CPU-A7543	Cisco HX EXP AMD 2.8GHz 7543 225W 32C/256MB Cache DDR4 3200MHz
HXE-CPU-A7413	Cisco HX EXP AMD 2.65GHz 7413 180W24C/128MBCacheDDR4 3200MHz
CPU Accessories	
UCSC-HSLP-M6=	Heatsink for 1U/2U LFF/SFF GPU SKU
UCS-CPU-TIM=	Single CPU thermal interface material syringe for M5 server HS seal ¹
UCS-M6-CPU-CAR=	Spare CPU Carrier for M6
UCSX-HSCK=	UCS Processor Heat Sink Cleaning Kit (when replacing a CPU)
UCS-CPUAT=	CPU Assembly Tool for M6 Servers
Memory²	
3200-MHz DIMMs	

Table 17 Spare Parts (continued)

Product ID (PID)	PID Description
HX-MR-X16G1RW=	16 GB RDIMM SRx4 3200 (8Gb)
HX-MR-X32G1RW=	32 GB RDIMM SRx4 3200 (16Gb)
HX-MR-X32G2RW=	32 GB RDIMM DRx4 3200 (8Gb)
HX-MR-X64G2RW=	64 GB RDIMM DRx4 3200 (16Gb)
DIMM Blank	
UCS-DIMM-BLK=	UCS DIMM Blank
HXAF225C-M6S-EXP (All Flash)	
Front Capacity Drive	
HX-SD960G61X-EV=	960GB 2.5 inch Enterprise Value 6G SATA SSD
HX-SD19T61X-EV=	1.9TB 2.5 inch Enterprise Value 6G SATA SSD
HX-SD38T61X-EV=	3.8TB 2.5 inch Enterprise Value 6G SATA SSD
HX-SD76T61X-EV=	7.6TB 2.5 inch Enterprise Value 6G SATA SSD
HX-SD38T6S1X-EV=	3.8TB 2.5inch Enterprise Value 6G SATA SSD
HX-SD76T6S1X-EV=	7.6TB 2.5inch Enterprise Value 6G SATA SSD
Front Cache Drive	
HX-SD800GK3X-EP=	800GB 2.5in Enterprise Performance 12G SAS SSD(3X endurance)
HX-NVMEM6-W1600=	1.6TB 2.5in U.2 WD SN840 NVMe Extreme Perf. High Endurance
HX-NVMEXPB-I375=	375GB 2.5in Intel Optane NVMe Extreme Performance SSD
Front System Drive	
HX-SD240GM1X-EV=	240GB 2.5 inch Enterprise Value 6G SATA SSD
Boot Drives	
HX-M2-240GB=	240GB SATA M.2
HX-M2-HWRAID=	Cisco Boot optimized M.2 Raid controller
HX225C-M6S-EXP (Hybrid)	
Front Capacity Drive	
HX-HD12TB10K12N=	1.2 TB 12G SAS 10K RPM SFF HDD
HX-HD18TB10K4KN=	1.8TB 12G SAS 10K RPM SFF HDD (4K)
HX-HD24TB10K4KN=	2.4 TB 12G SAS 10K RPM SFF HDD (4K)
Front Cache Drive	

Table 17 Spare Parts (continued)

Product ID (PID)	PID Description
HX-SD480G63X-EP=	480GB 2.5in Enterprise Performance 6GSATA SSD(3X endurance)
HX-SD800GK3X-EP=	800GB 2.5in Enterprise Performance 12G SAS SSD(3X endurance)
Boot Drives	
HX-M2-240GB=	240GB SATA M.2
HX-M2-HWRAID=	Cisco Boot optimized M.2 Raid controller
Drive Blanking Panel	
UCSC-BBLKD-S2=	C-Series M5 SFF drive blanking panel
Drive Controllers	
HX-SAS-220M6=	Cisco 12G SAS HBA
Drive Controller Cables	
CBL-SAS-C220M6=	C220M6 SAS cable (1U);
Modular LAN on Motherboard (mLOM)	
HX-M-V25-04=	Cisco UCS VIC 1467 Quad Port 10/25G SFP28 mLOM
HX-M-V100-04=	Cisco UCS VIC 1477 Quad Port 40/100G QSFP28 mLOM
Virtual Interface Card (VICs)	
HX-PCIE-C100-04=	Cisco UCS VIC 1495 Dual Port 40/100G QSFP28 CNA PCIe
HX-PCIE-C25Q-04=	Cisco UCS VIC 1455 Quad Port 10/25G SFP28 PCIe
Network Interface Cards (NICs)	
1 Gb NICs	
HX-PCIE-IRJ45	Intel i350 quad-port 1G copper PCIe
10 Gb NICs	
HX-PCIE-ID10GF	Intel X710-DA2 Dual Port 10Gb SFP+ NIC
HX-P-ID10GC	Cisco-Intel X710T2LG 2x10 GbE RJ45 PCIe NIC
HX-PCIE-IQ10GF	Intel X710 quad-port 10G SFP+ NIC
25 Gb NICs	
HX-P-I8D25GF	Cisco-Intel E810XXVDA2 2x25/10 GbE SFP28 PCIe NIC
HX-P-I8Q25GF	Cisco-Intel E810XXVDA4L 4x25/10 GbE SFP28 PCIe NIC
GPU³	
HX-GPU-T4-16=	NVIDIA T4 PCIE 75W 16GB

Table 17 Spare Parts (continued)

Product ID (PID)	PID Description
Power Supplies	
PSU (Input High Line 120VAC)	
HX-PSU1-1050W=	1050W AC PSU Platinum (Not EU/UK Lot 9 Compliant)s
HX-PSUV2-1050DC=	1050W DC power supply for Rack servers
HX-PSU1-1600W=	1600W AC PSU Platinum (Not EU/UK Lot 9 Compliant)s
PSU (Input Low Line 110VAC)	
HX-PSU1-1050W=	1050W AC PSU Platinum (Not EU/UK Lot 9 Compliant)s
HX-PSUV2-1050DC=	1050W DC power supply for Rack servers
UCSC-PSU-M5BLK=	Power Supply Blanking Panel for M5 servers
Power Cables	
CAB-48DC-40A-8AWG=	C-Series -48VDC PSU Power Cord, 3.5M, 3 Wire, 8AWG, 40A
CAB-N5K6A-NA=	Power Cord, 200/240V 6A, North America
CAB-AC-L620-C13=	AC Power Cord, NEMA L6-20 - C13, 2M/6.5ft
CAB-C13-CBN=	CABASY,WIRE,JUMPER CORD, 27" L, C13/C14, 10A/250V
CAB-C13-C14-2M=	CABASY,WIRE,JUMPER CORD, PWR, 2 Meter, C13/C14,10A/250V
CAB-C13-C14-AC=	CORD,PWR,JMP,IEC60320/C14,IEC6 0320/C13, 3.0M
CAB-250V-10A-AR=	Power Cord, 250V, 10A, Argentina
CAB-9K10A-AU=	Power Cord, 250VAC 10A 3112 Plug, Australia
CAB-250V-10A-CN=	AC Power Cord - 250V, 10A - PRC
CAB-9K10A-EU=	Power Cord, 250VAC 10A CEE 7/7 Plug, EU
CAB-250V-10A-ID=	Power Cord, 250V, 10A, India
CAB-C13-C14-3M-IN=	Power Cord Jumper, C13-C14 Connectors, 3 Meter Length, India
CAB-C13-C14-IN=	Power Cord Jumper,C13-C14 Connectors,1.4 Meter Length, India
CAB-250V-10A-IS=	Power Cord, SFS, 250V, 10A, Israel
CAB-9K10A-IT=	Power Cord, 250VAC 10A CEI 23-16/VII Plug, Italy
CAB-9K10A-SW=	Power Cord, 250VAC 10A MP232 Plug, Switzerland
CAB-9K10A-UK=	Power Cord, 250VAC 10A BS1363 Plug (13 A fuse), UK
CAB-9K12A-NA=	Power Cord, 125VAC 13A NEMA 5-15 Plug, North America
CAB-250V-10A-BR=	Power Cord - 250V, 10A - Brazil

Table 17 Spare Parts (continued)

Product ID (PID)	PID Description
CAB-C13-C14-2M-JP=	Power Cord C13-C14, 2M/6.5ft Japan PSE mark
CAB-9K10A-KOR ¹ =	Power Cord, 125VAC 13A KSC8305 Plug, Korea
CAB-JPN-3PIN=	Japan, 90-125VAC 12A NEMA 5-15 Plug, 2.4m
CAB-48DC-40A-AS=	C-Series -48VDC PSU PWR Cord, 3.5M, 3Wire, 8AWG, 40A (AS/NZ)
CAB-48DC-40A-INT=	C-Series -48VDC PSU PWR Cord, 3.5M, 3 Wire, 8AWG, 40A (INT)
Rail Kit	
HX-RAIL-M6=	Ball Bearing Rail Kit for C220 & C240 M6 rack servers
CMA	
HX-CMA-240M6=	Reversible CMA for C240 M6 ball bearing rail kit
Security	
UCSX-TPM-OPT-OUT=	OPT OUT, TPM 2.0, TCG, FIPS140-2, CC EAL4+ Certified
HX-TPM-002C=	TPM 2.0, TCG, FIPS140-2, CC EAL4+ Certified, for M6 servers
HX-INT-SW02=	C220 and C240 M6 Chassis Intrusion Switch
Bezel	
HXAF220C-BZL-M5S=	HXAF220C M5 Security Bezel
HX220C-BZL-M5=	HX220C M5 Security Bezel
VMware PAC Licenses	
HX-VSP-EPL-1A=	VMware vSphere 7.x Ent Plus (1 CPU, 32 core), 1-yr, Support Required
HX-VSP-EPL-3A=	VMware vSphere 7.x Ent Plus (1 CPU, 32 core), 3-yr, Support Required
HX-VSP-EPL-5A=	VMware vSphere 7.x Ent Plus (1 CPU, 32 core), 5-yr, Support Required
HX-VSP-STD-1A=	VMware vSphere 7.x Standard (1 CPU, 32 core), 1-yr, Support Required
HX-VSP-STD-3A=	VMware vSphere 7.x Standard (1 CPU, 32 core), 3-yr, Support Required
HX-VSP-STD-5A=	VMware vSphere 7.x Standard (1 CPU, 32 core), 5-yr, Support Required

Notes:

1. This part is included with the purchase of option or spare CPU or CPU processor kits.
2. For the more details on memory configuration and mixing rules refer the [Cisco HyperFlex M6 Memory Guide](#).
3. Refer to [Installation guide](#) for installing GPUs.

SUPPLEMENTAL MATERIAL

Chassis

Internal views of the HX225C M6S All Flash and Hybrid chassis with the top cover removed are shown in [Figure 7](#) and [Figure 8 on page 40](#).

Figure 7 HyperFlex Express HX225C M6S All Flash and Hybrid With Top Cover Off (full-height, full-width PCIe cards)

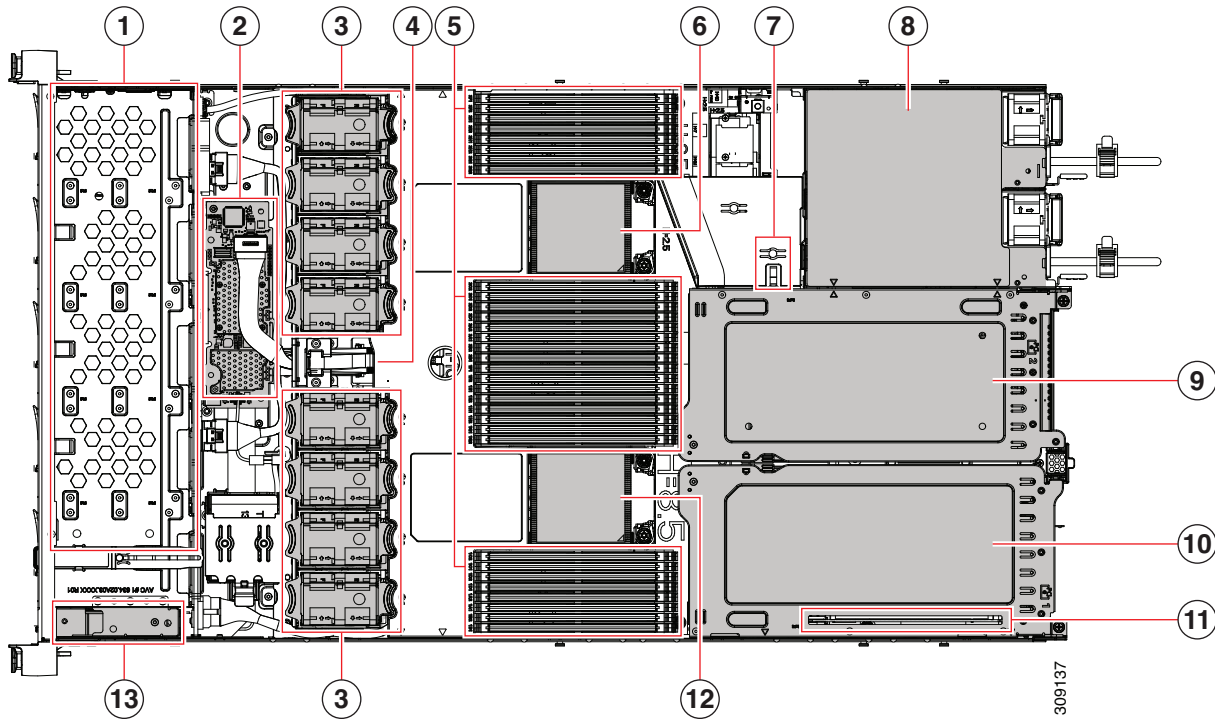

1	Front-loading drive bays	2	M6 modular RAID card
3	Cooling fan modules (eight) Each fan is hot-swappable	4	Supercap module mounting bracket
5	DIMM sockets on motherboard, 32 total, 16 per CPU CPUs are arranged in groups of eight sockets above the top CPU and below the bottom CPU, and 16 sockets between the CPUs.	6	Motherboard CPU2 socket
7	M.2 module connector, supporting a boot-optimized RAID controller with connectors for up to two SATA M.2 SSDs.	8	Two power supplies
9	PCIe riser 2 Accepts 1 full height, full width PCIe riser card	10	PCIe riser 1 Accepts 1 full height, full width PCIe riser card

11	Modular LOM (mLOM) card bay on chassis floor(x16 PCIe lane) Connector shown, but the card bay sits below PCIe riser slot 1.	12	Motherboard CPU1 socket
13	Front Panel Controller board	-	

Figure 8 HyperFlex Express HX225C M6S All Flash and Hybrid With Top Cover Off (full-height, half-width PCIe cards)

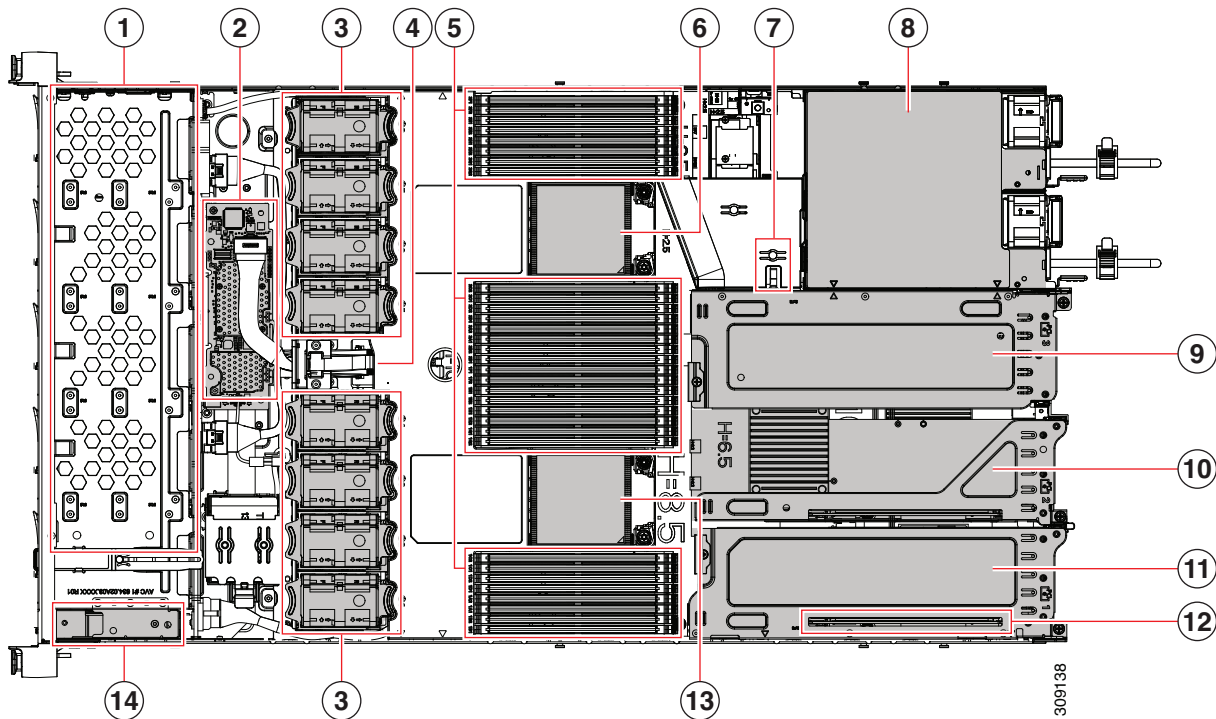

1	Front-loading drive bays	2	M6 modular RAID card
3	Cooling fan modules (eight) Each fan is hot-swappable	4	Supercap module mounting bracket
5	DIMM sockets on motherboard, 32 total, 16 per CPU CPUs are arranged in groups of eight sockets above the top CPU and below the bottom CPU, and 16 sockets between the CPUs.	6	Motherboard CPU2 socket
7	M.2 module connector, supporting a boot-optimized RAID controller with connectors for up to two SATA M.2 SSDs.	8	Two power supplies
9	PCIe riser 3 Accepts 1 half height, half width PCIe riser card	10	PCIe riser 2 Accepts 1 half height, half width PCIe riser card

11	PCIe riser slot 1 Accepts 1 half height, half width PCIe riser card	12	Modular LOM (mLOM) card bay on chassis floor(x16 PCIe lane) Connector shown, but the card bay sits below PCIe riser slot 1.
13	Motherboard CPU1 socket	14	Front Panel Controller board

Risers

Figure 9 shows the locations of the PCIe riser connectors on the HyperFlex Express HX225C M6S All Flash and Hybrid Server Nodes motherboard. The allowed configurations are:

- Half-height risers in riser 1, 2, and 3 connectors (see Figure 10), or
- Full-height risers in riser 1 and 3 connectors (see Figure 11).

Figure 9 HyperFlex Express HX225C M6S All Flash and Hybrid Server Nodes Riser Connector Locations
C225 M6 SFF Motherboard

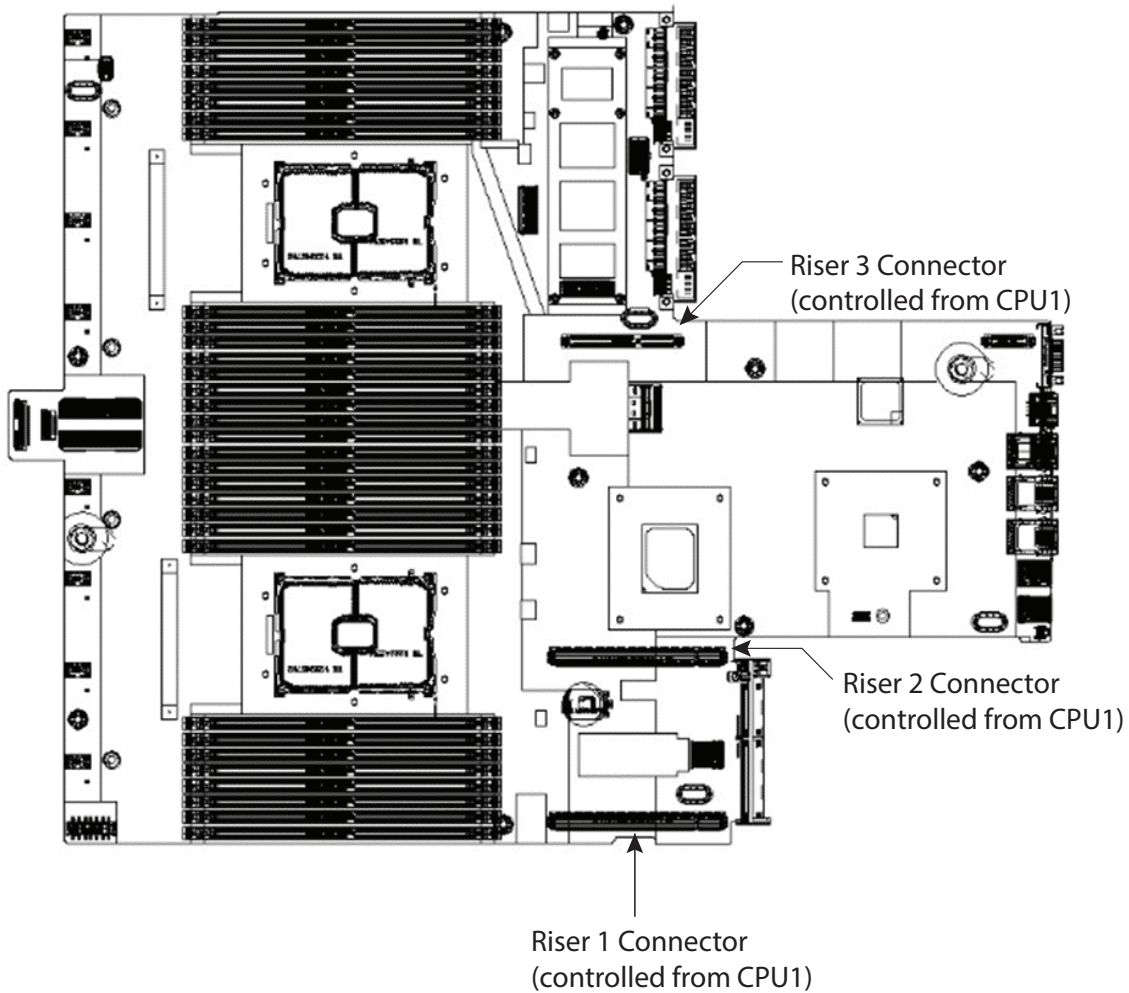

Figure 10 shows three half-height risers plugged into their respective connectors.

Figure 10 HyperFlex Express HX225C M6S All Flash and Hybrid Server Nodes With Three Half-Height Risers Plugged In
C225 M6 SFF Motherboard

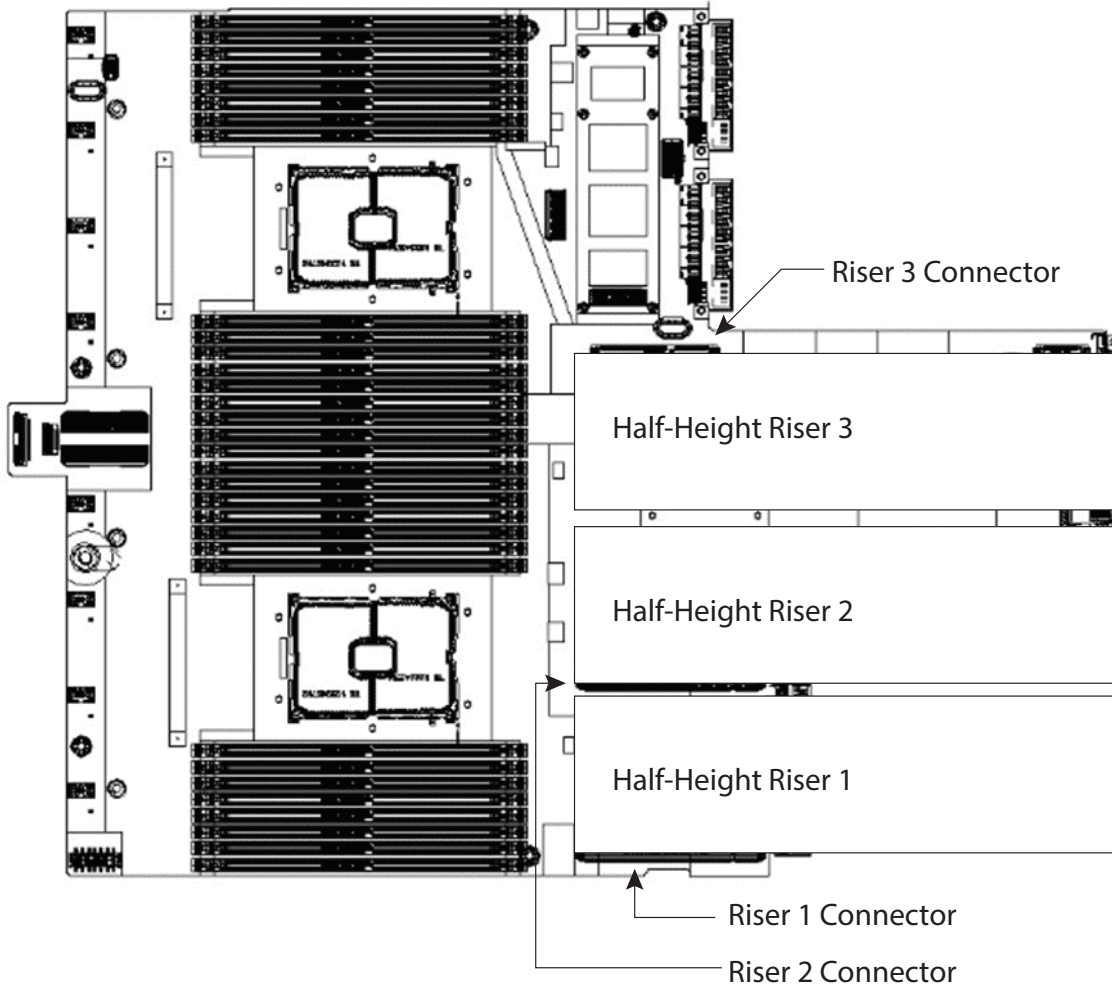
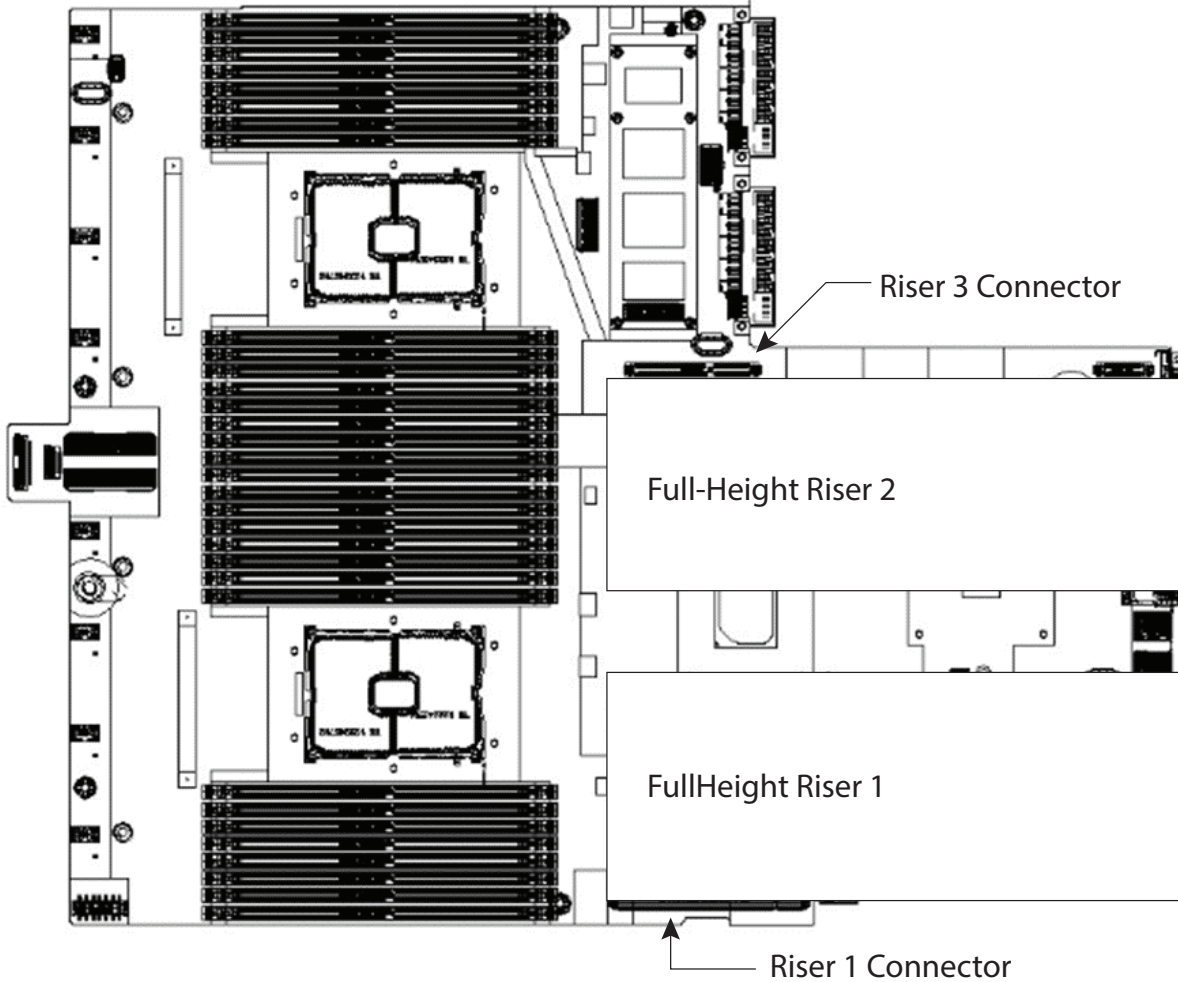

Figure 11 shows two full-height risers plugged in. Note that riser 1 is plugged into the riser 1 connector and riser 2 is plugged into the riser 3 connector. Riser 2 connector is not used.

Figure 11 HyperFlex Express HX225C M6S All Flash and Hybrid Server Nodes With Two Full-Height Risers Plugged In

C225 M6 SFF Motherboard



UPGRADING or REPLACING CPUs



NOTE: Before servicing any CPU, do the following:

- Decommission and power off the server.
- Slide the HX225C M6 All Flash and Hybrid Server Nodes out from the rack.
- Remove the top cover.

To replace an existing CPU, follow these steps:

(1) Have the following tools and materials available for the procedure:

- T-30 Torx driver—Supplied with replacement CPU.
- #1 flat-head screwdriver—Supplied with replacement CPU.
- CPU assembly tool—Supplied with replacement CPU. Can be ordered separately as Cisco PID UCS-CPUAT=.
- Heatsink cleaning kit—Supplied with replacement CPU. Can be ordered separately as Cisco PID UCSX-HSCK=.
- Thermal interface material (TIM)—Syringe supplied with replacement CPU. Can be ordered separately as Cisco PID UCS-CPU-TIM=.

(2) Order the appropriate replacement CPU from [Table 4 Available CPUs, page 21](#)

Carefully remove and replace the CPU and heatsink in accordance with the instructions found in “Cisco M5 Server Installation and Service Guide,” found at:

https://www.cisco.com/content/en/us/td/docs/unified_computing/ucs/c/hw/c220m6/install/c220m6.html

To add a new CPU, follow these steps:

(1) Have the following tools and materials available for the procedure:

- T-30 Torx driver—Supplied with new CPU.
- #1 flat-head screwdriver—Supplied with new CPU
- CPU assembly tool—Supplied with new CPU. Can be ordered separately as Cisco PID UCS-CPUAT=
- Thermal interface material (TIM)—Syringe supplied with replacement CPU. Can be ordered separately as Cisco PID UCS-CPU-TIM=

(2) Order the appropriate new CPU from [Table 4 Available CPUs, page 21](#)

(3) Order one heat sink for each new CPU. Order PID UCSC-HSLP-M6=.

Carefully install the CPU and heatsink in accordance with the instructions found in “Cisco M5 Server Installation and Service Guide,” found at:

https://www.cisco.com/content/en/us/td/docs/unified_computing/ucs/c/hw/c220m6/install/c220m6.html

UPGRADING or REPLACING MEMORY



NOTE: Before servicing any DIMM do the following:

- Decommission and power off the server.
- Remove the top cover from the server
- Slide the server out the front of the chassis.

To add or replace DIMMs follow these steps:

Step 1 Open both DIMM connector latches.

Step 2 Press evenly on both ends of the DIMM until it clicks into place in its slot

Note: Ensure that the notch in the DIMM aligns with the slot. If the notch is misaligned, it is possible to damage the DIMM, the slot, or both.

Step 3 Press the DIMM connector latches inward slightly to seat them fully.

Step 4 Populate all slots with a DIMM or DIMM blank. A slot cannot be empty.

Figure 12 Replacing Memory

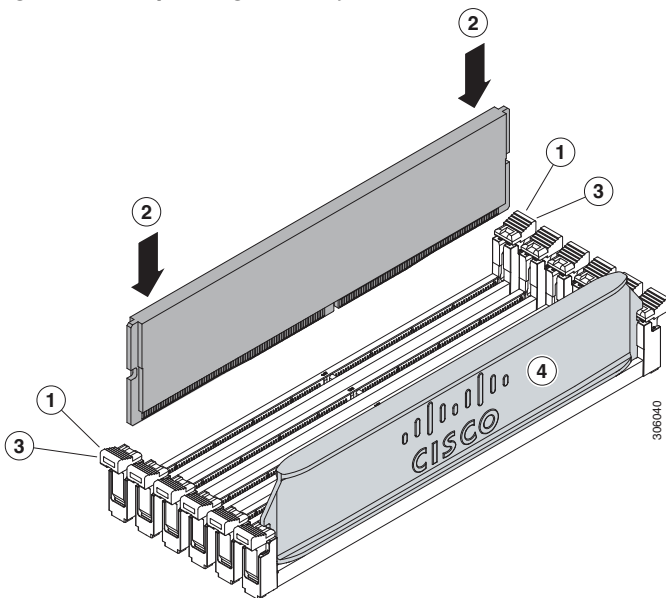

TECHNICAL SPECIFICATIONS

Dimensions and Weight

Table 18 HyperFlex Express HX225C M6 All Flash and Hybrid Server Nodes Dimensions and Weight

Parameter	Value
Height	1.70 in. (4.3 cm)
Width (including slam latches)	16.9 in. (42.9 cm)
Depth	30 in. (76.2 cm)
Front Clearance	3 in. (76 mm)
Side Clearance	1 in. (25 mm)
Rear Clearance	6 in. (152 mm)
Weight	
Weight with following options and no rail kit: 1 HDD, 1 CPU, 1 DIMM, and 1 1600 W power supply	22.32 lbs (10.1 kg)
Weight with following options and including rail kit: 1 HDD, 1 CPU, 1 DIMM, and 1 1600 W power supply	32.38 lbs (14.7 kg)
Weight with following options and no rail kit: 10 HDDs, 2 CPUs, 32 DIMMs, and 2 1600 W power supplies	32.38 lbs (14.7 kg)
Weight with following options and including rail kit: 10 HDDs, 2 CPUs, 32 DIMMs, and 2 1600 W power supplies	42.43 lbs (19.3 kg)

Power Specifications

The Cisco HyperFlex Express HX225C M6 All Flash and Hybrid Server Nodes is available with the following types of power supplies:

- 1050 W (AC) power supply (see [Table 19](#)).
- 1050 W V2 (DC) power supply (see [Table 20](#)).
- 1600 W (AC) power supply (see [Table 21](#)).

Table 19 Cisco HyperFlex Express HX225C M6 All Flash and Hybrid Server Nodes Power Specifications (1050 W AC power supply)

Parameter	Specification			
Input Connector	IEC320 C14			
Input Voltage Range (V rms)	100 to 240			
Maximum Allowable Input Voltage Range (V rms)	90 to 264			
Frequency Range (Hz)	50 to 60			
Maximum Allowable Frequency Range (Hz)	47 to 63			
Maximum Rated Output (W) ¹	800		1050	
Maximum Rated Standby Output (W)	36			
Nominal Input Voltage (V rms)	100	120	208	230
Nominal Input Current (A rms)	9.2	7.6	5.8	5.2
Maximum Input at Nominal Input Voltage (W)	889	889	1167	1154
Maximum Input at Nominal Input Voltage (VA)	916	916	1203	1190
Minimum Rated Efficiency (%) ²	90	90	90	91
Minimum Rated Power Factor ²	0.97	0.97	0.97	0.97
Maximum Inrush Current (A peak)	15			
Maximum Inrush Current (ms)	0.2			
Minimum Ride-Through Time (ms) ³	12			

Notes:

1. Maximum rated output is limited to 800W when operating at low-line input voltage (100-127V).
2. This is the minimum rating required to achieve 80 PLUS Platinum certification, see test reports published at <http://www.80plus.org/> for certified values.
3. Time output voltage remains within regulation limits at 100% load, during input voltage dropout.

Table 20 Cisco HyperFlex Express HX225C M6 All Flash and Hybrid Server Nodes Power Specifications (1050 W V2 DC power supply)

Parameter	Specification
Input Connector	Molex 42820
Input Voltage Range (V rms)	-48
Maximum Allowable Input Voltage Range (V rms)	-40 to -72
Frequency Range (Hz)	NA
Maximum Allowable Frequency Range (Hz)	NA
Maximum Rated Output (W)	1050
Maximum Rated Standby Output (W)	36
Nominal Input Voltage (V rms)	-48
Nominal Input Current (A rms)	24
Maximum Input at Nominal Input Voltage (W)	1154
Maximum Input at Nominal Input Voltage (VA)	1154
Minimum Rated Efficiency (%) ¹	91
Minimum Rated Power Factor ¹	NA
Maximum Inrush Current (A peak)	15
Maximum Inrush Current (ms)	0.2
Minimum Ride-Through Time (ms) ²	5

Notes:

1. This is the minimum rating required to achieve 80 PLUS Platinum certification, see test reports published at <http://www.80plus.org/> for certified values.
2. Time output voltage remains within regulation limits at 100% load, during input voltage dropout.

Table 21 Cisco HyperFlex Express HX225C M6 All Flash and Hybrid Server Nodes 1600 W (AC) Power Supply Specifications

Parameter	Specification			
Input Connector	IEC320 C14			
Input Voltage Range (V rms)	200 to 240			
Maximum Allowable Input Voltage Range (V rms)	180 to 264			
Frequency Range (Hz)	50 to 60			
Maximum Allowable Frequency Range (Hz)	47 to 63			
Maximum Rated Output (W) ¹	1600			
Maximum Rated Standby Output (W)	36			
Nominal Input Voltage (V rms)	100	120	208	230
Nominal Input Current (A rms)	NA	NA	8.8	7.9
Maximum Input at Nominal Input Voltage (W)	NA	NA	1778	1758
Maximum Input at Nominal Input Voltage (VA)	NA	NA	1833	1813
Minimum Rated Efficiency (%) ²	NA	NA	90	91
Minimum Rated Power Factor ²	NA	NA	0.97	0.97
Maximum Inrush Current (A peak)	30			
Maximum Inrush Current (ms)	0.2			
Minimum Ride-Through Time (ms) ³	12			

Notes:

1. Maximum rated output is limited to 800W when operating at low-line input voltage (100-127V).
2. This is the minimum rating required to achieve 80 PLUS Platinum certification, see test reports published at <http://www.80plus.org/> for certified values.
3. Time output voltage remains within regulation limits at 100% load, during input voltage dropout.

For configuration-specific power specifications, use the Cisco UCS Power Calculator at this URL:

<http://ucspowercalc.cisco.com>

Environmental Specifications

The environmental specifications for the C225 M6 server are listed in [Table 22](#).

Table 22 M6 Environmental Specifications

Parameter	Minimum
Operating Temperature	Dry bulb temperature of 10°C to 35°C (50°F to 95°F) Maximum temperature change of 20°C (36°F) per hour (a temperature change within a specified period of time and not a rate of change) Humidity condition: Uncontrolled, not to exceed 50% RH starting condition Derate the maximum temperature by 1°C (33.8°F) per every 305 meters of altitude above 900m
Extended Operating Temperature	5°C to 40°C (41°F to 104°F) with no direct sunlight Humidity condition: Uncontrolled, not to exceed 50% RH starting condition Derate the maximum temperature by 1°C (33.8°F) per every 305 meters of altitude above 900m
Non-Operating Temperature	Dry bulb temperature of -40°C to 65°C (-40°F to 149°F)
Operating Relative Humidity	10% to 90% and 28°C (82.4°F) maximum dew-point temperature, non-condensing environment Minimum to be higher (more moisture) of -12°C (10.4°F) dew point or 8% relative humidity Maximum to be 24°C (75.2°F) dew point or 90% relative humidity
Non-Operating Relative Humidity	5% to 93% relative humidity, non-condensing, with a maximum wet bulb temperature of 28°C across the 20°C to 40°C dry bulb range.
Maximum Operating Duration	Unlimited
Operating Altitude	A maximum elevation of 3050 meters (10,006 ft)
Non-Operating Altitude	An elevation of 0 to 12,000 meters (39,370 ft)
Sound Power level, Measure A-weighted per ISO7779 LWAd (Bels) Operation at 23°C (73°F)	5.5
Sound Pressure level, Measure A-weighted per ISO7779 LpAm (dBA) Operation at 23°C (73°F)	40

Extended Operating Temperature Hardware Configuration Limits

Table 23 Cisco HyperFlex Express HX225C M6 All Flash and Hybrid Server Nodes Extended Operating Temperature Hardware Configuration Limits

Platform ¹	ASHRAE A3 (5°C to 40°C) ²	ASHRAE A4 (5°C to 45°C) ³
Processors:	155W+	155W+ and 105W+ (4 or 6 Cores)
Memory:	LRDIMMs	LRDIMMs
Storage:	M.2 SATA SSDs NVMe SSDs	M.2 SATA SSDs NVMe SSDs
Peripherals:	PCIe NVMe SSDs GPUs	MRAID PCIe NVMe SSDs GPUs mLOMs VICs NICs HBAs

Notes:

1. Two PSUs are required and PSU failure is not supported
2. Non-Cisco UCS qualified peripherals and/or peripherals that consume more than 25W are not supported
3. High power or maximum power fan control policy must be applied

Compliance Requirements

The regulatory compliance requirements for HX-Series servers are listed in [Table 24](#).

Table 24 HX-Series Regulatory Compliance Requirements

Parameter	Description
Regulatory Compliance	Products should comply with CE Markings per directives 2014/30/EU and 2014/35/EU
Safety	UL 60950-1 Second Edition CAN/CSA-C22.2 No. 60950-1 Second Edition EN 60950-1 Second Edition IEC 60950-1 Second Edition AS/NZS 60950-1 GB4943 2001
EMC - Emissions	47CFR Part 15 (CFR 47) Class A AS/NZS CISPR32 Class A CISPR32 Class A EN55032 Class A ICES003 Class A VCCI Class A EN61000-3-2 EN61000-3-3 KN32 Class A CNS13438 Class A
EMC - Immunity	EN55024 CISPR24 EN300386 KN35



Americas Headquarters
Cisco Systems, Inc.
San Jose, CA

Asia Pacific Headquarters
Cisco Systems (USA) Pte. Ltd.
Singapore

Europe Headquarters
Cisco Systems International BV Amsterdam,
The Netherlands

Cisco has more than 200 offices worldwide. Addresses, phone numbers, and fax numbers are listed on the Cisco Website at www.cisco.com/go/offices.

Cisco and the Cisco Logo are trademarks of Cisco Systems, Inc. and/or its affiliates in the U.S. and other countries. A listing of Cisco's trademarks can be found at www.cisco.com/go/trademarks. Third party trademarks mentioned are the property of their respective owners. The use of the word partner does not imply a partnership relationship between Cisco and any other company. (1005R)

